

Michel Paradis  
McGill University

# BILINGUAL APHASIA TEST

(VIETNAMESE VERSION)

BẢN VIỆT NGỮ

STIMULUS BOOK

The development of the Bilingual Aphasia Test materials was supported by Grant MEQ 01-07-k (1976-1983) from the Quebec Ministry of Intergovernmental Affairs, Grant EQ 1660 (1980-1985) from the Quebec Ministry of Education FCAC Fund, and GRANTS 410-83-1028 (1984-1985) and 410-88-0821 (1989-1991) from the Social Sciences and Humanities Research Council of Canada.

HÌNH DÀNH CHO PHẦN  
PHÂN BIỆT ÂM THANH QUA LỜI NÓI

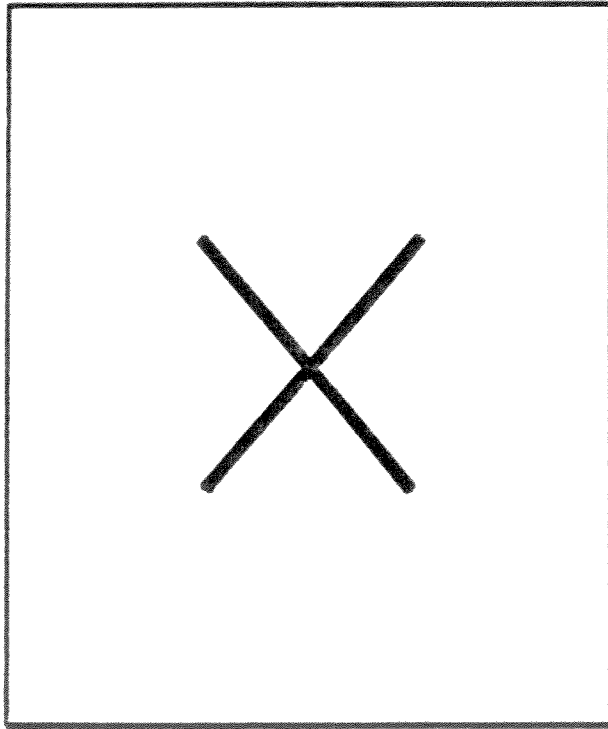

1

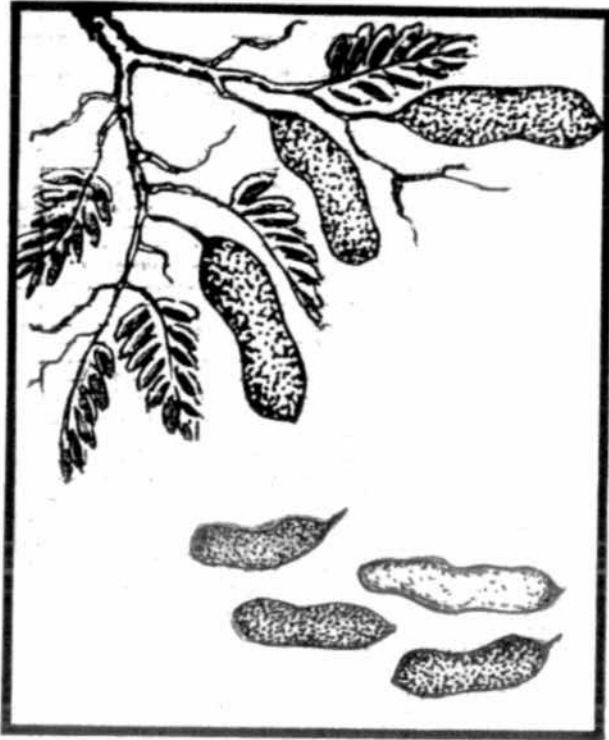

2

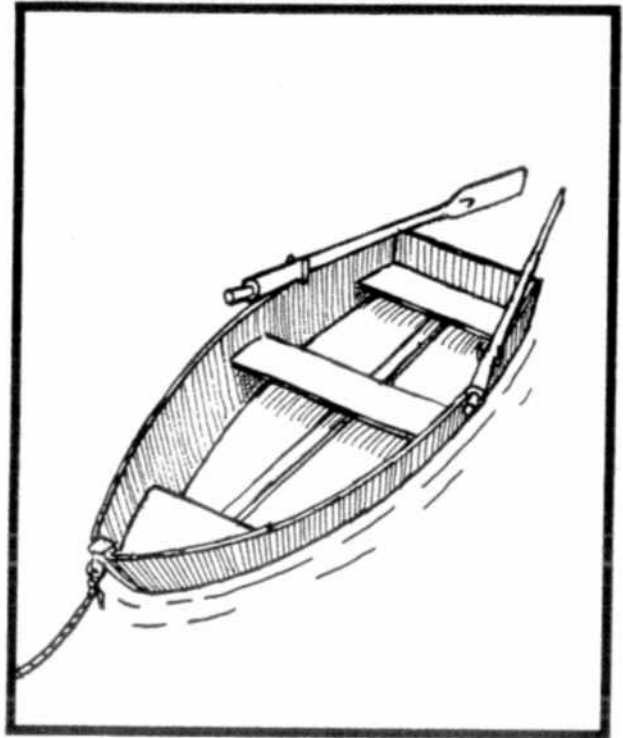

3

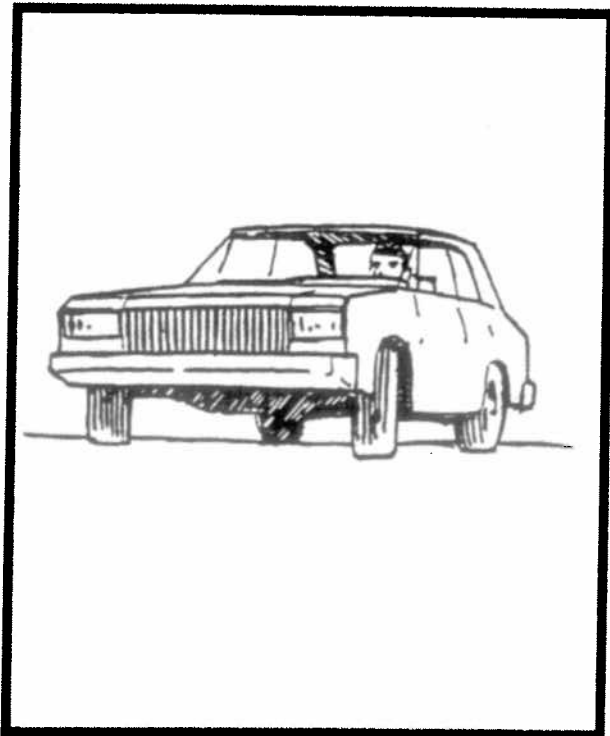

4



Ví dụ

1

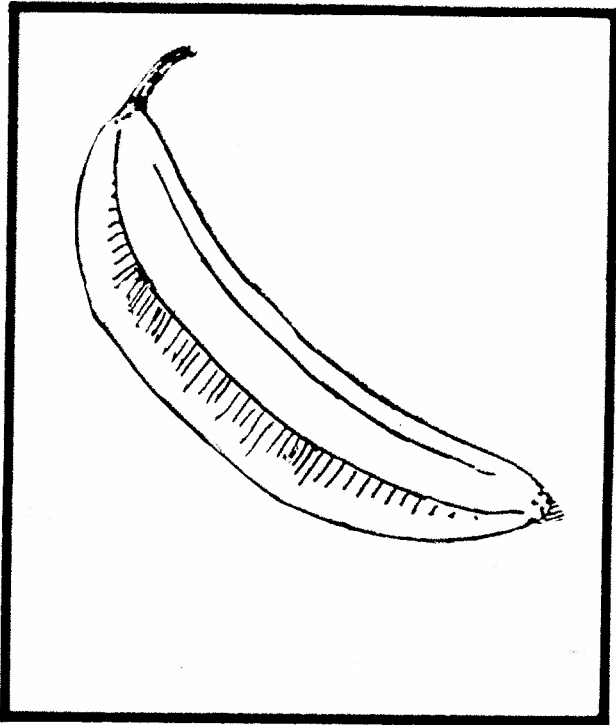

2



3

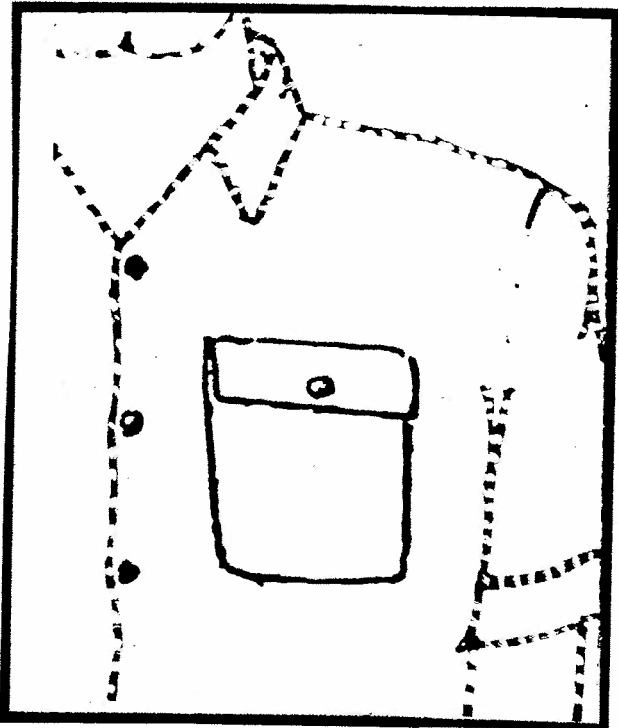

4

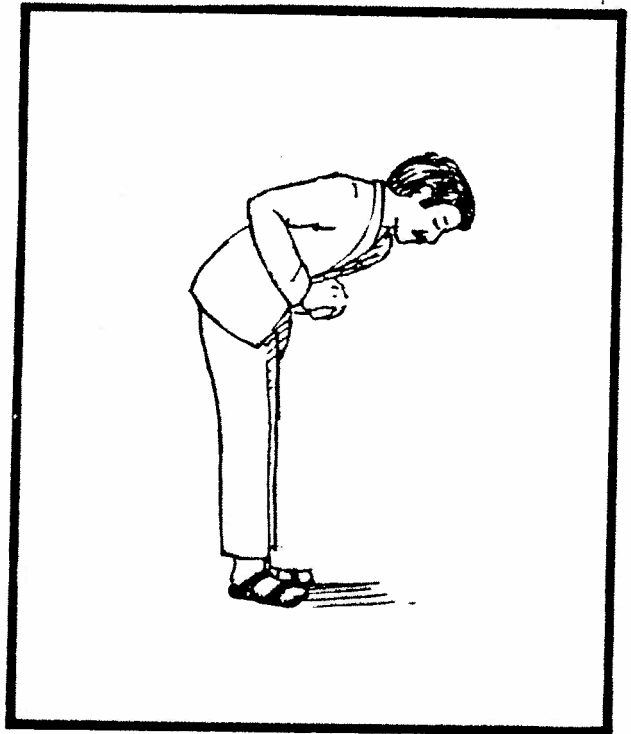

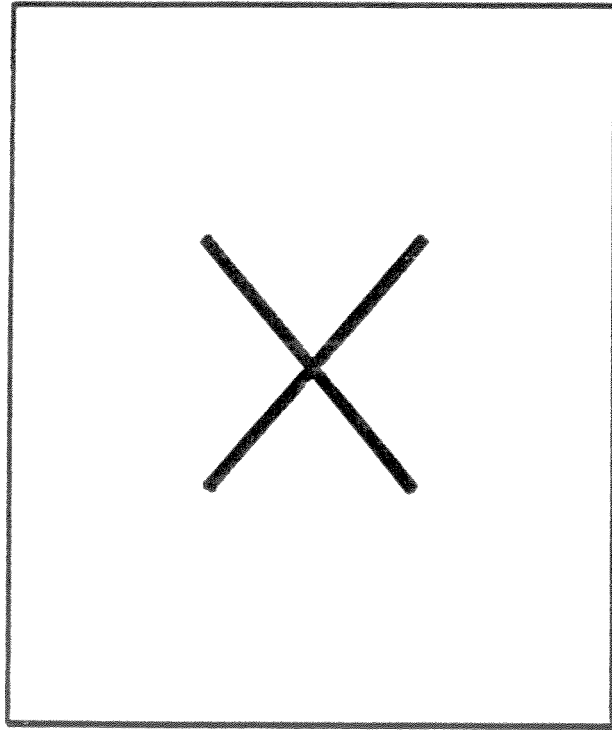

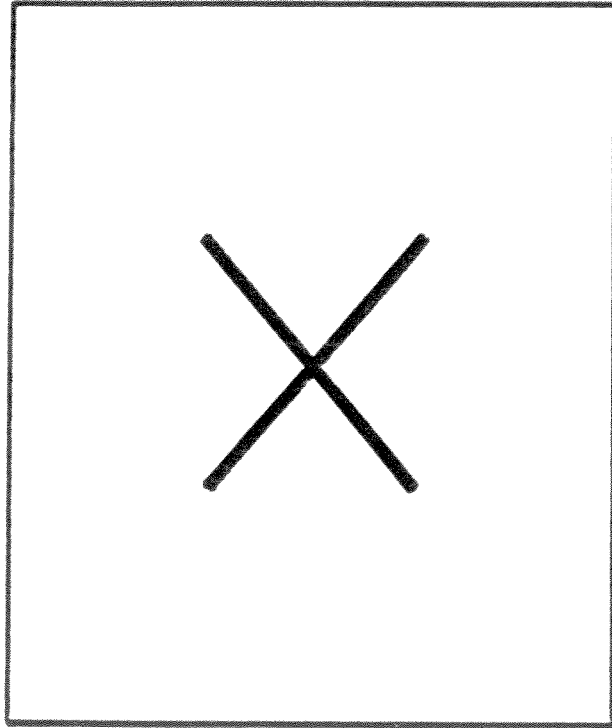



1

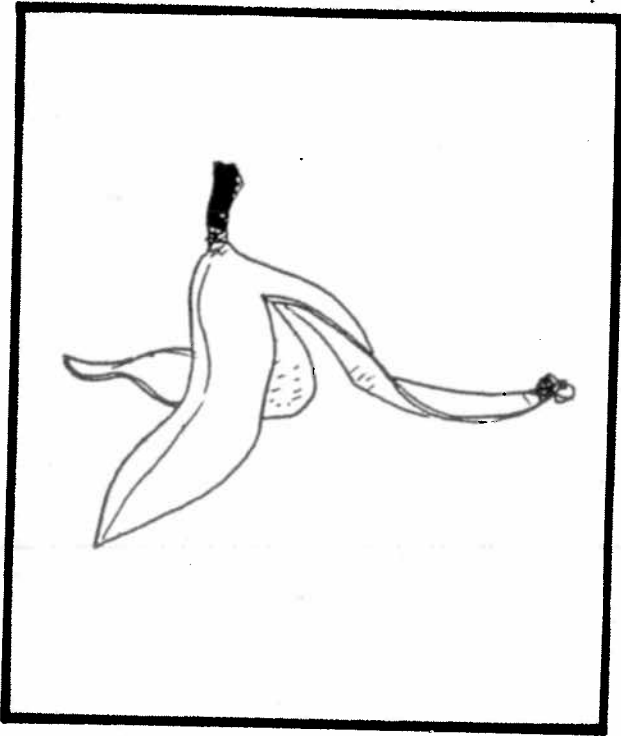

2

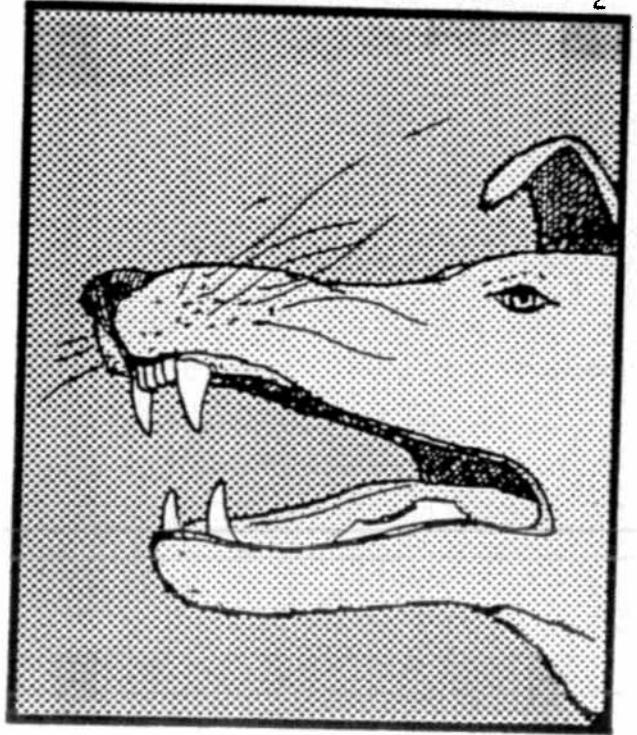

3

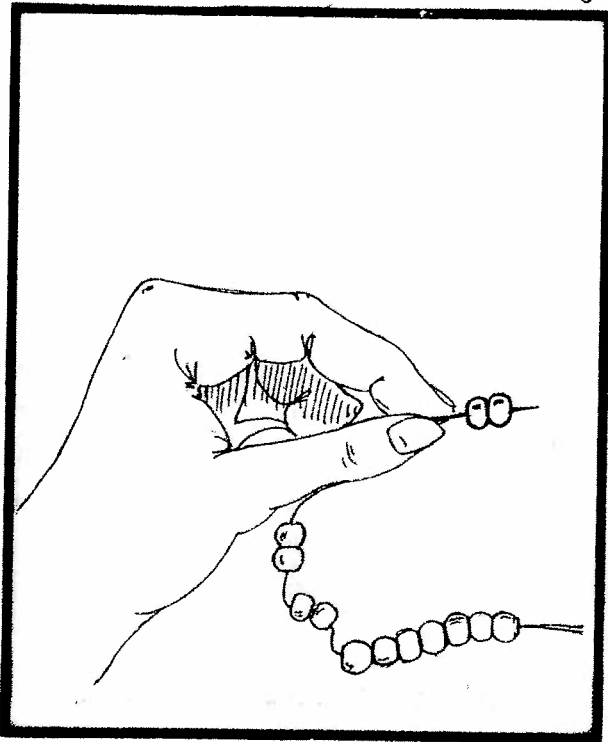

4

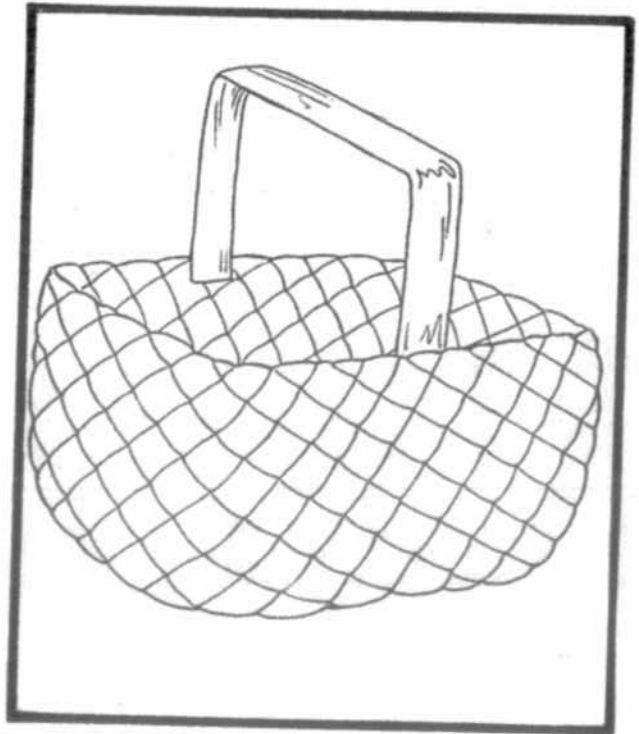

1

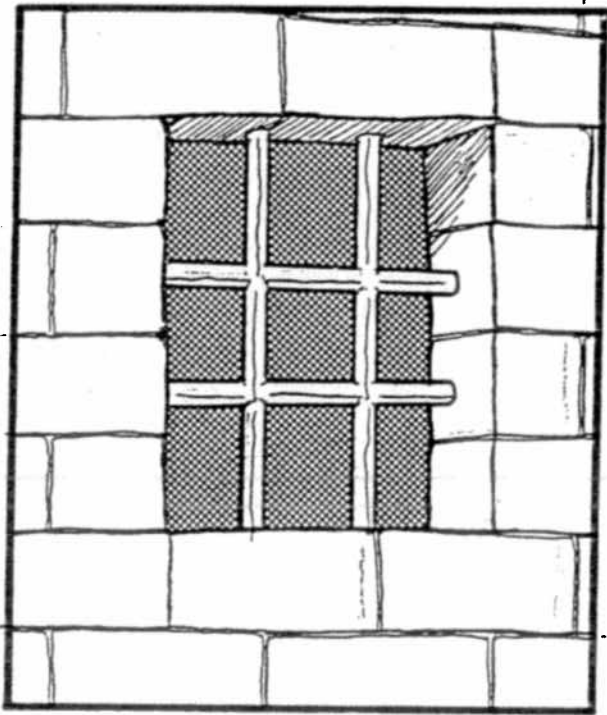

2

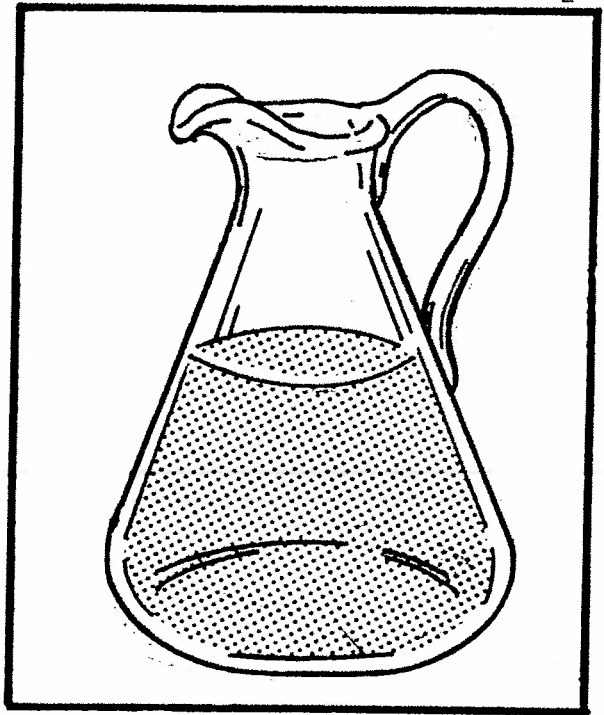

3

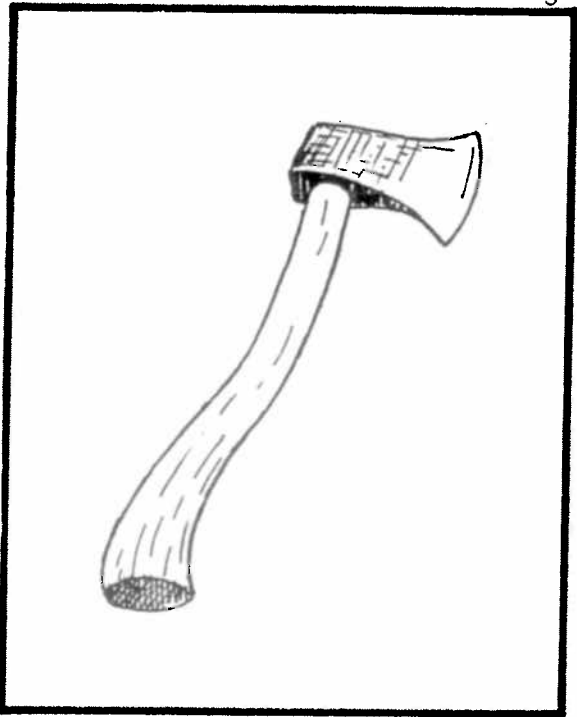

4

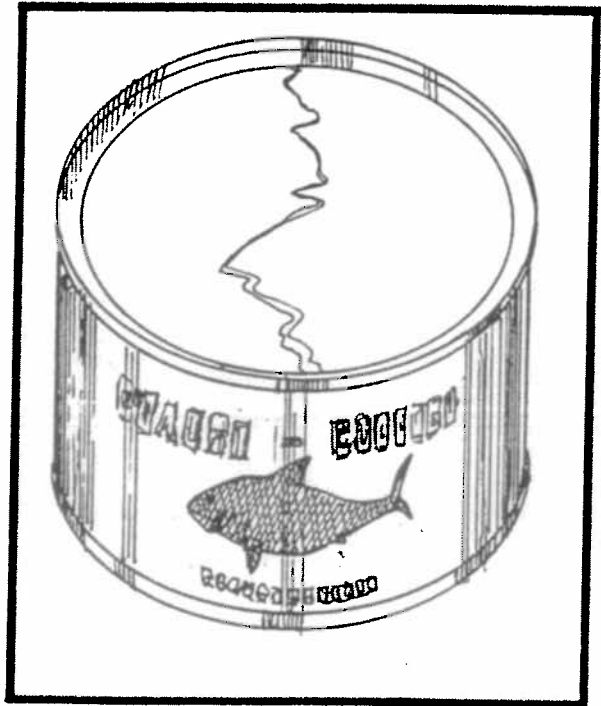

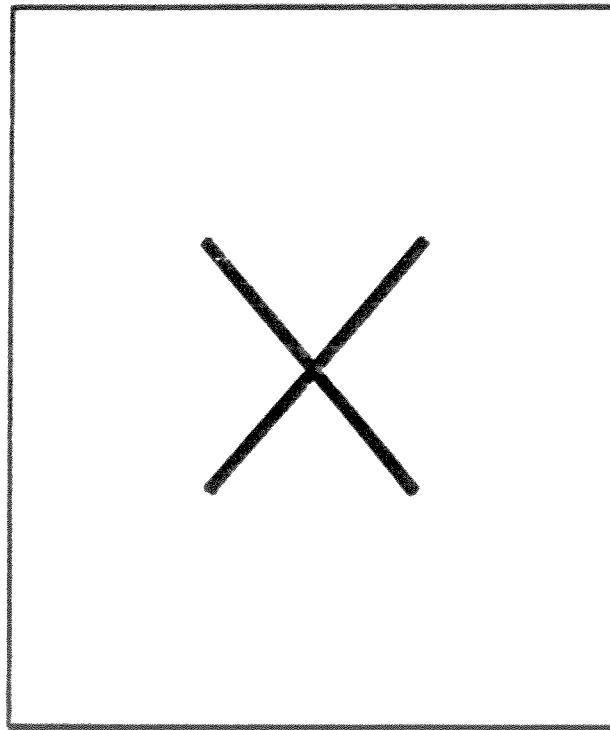

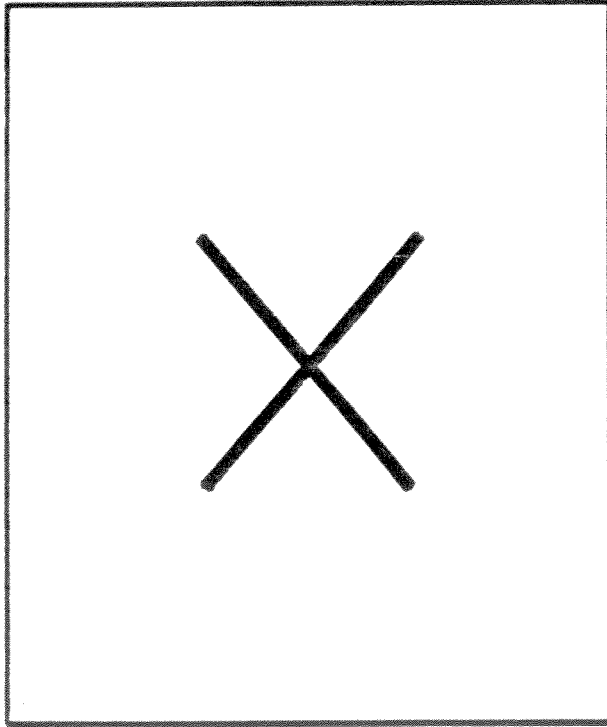

1



2

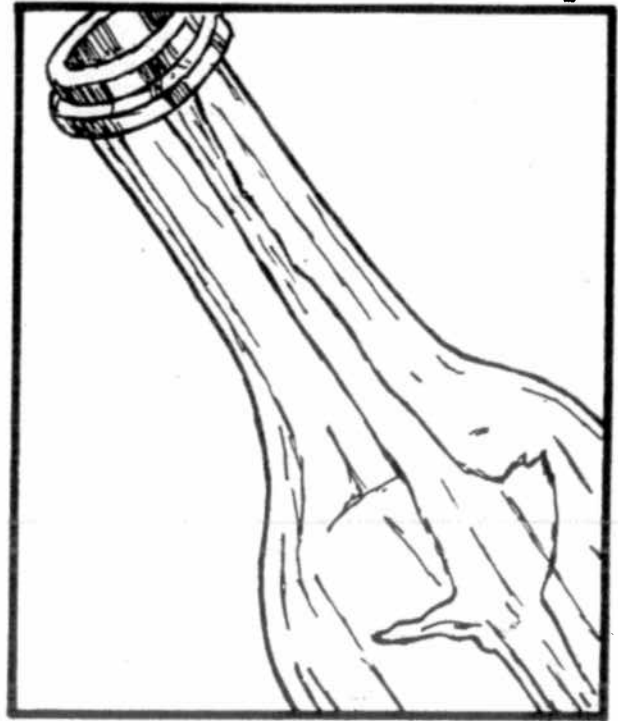

3

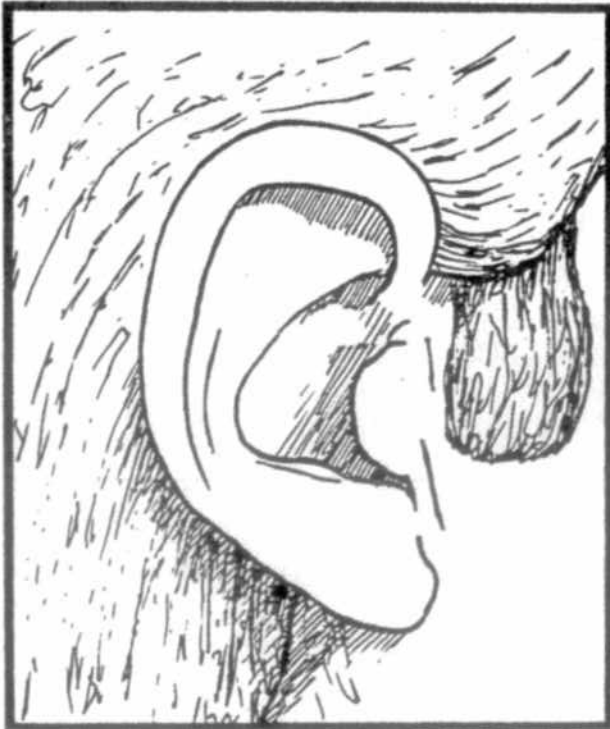

4



1

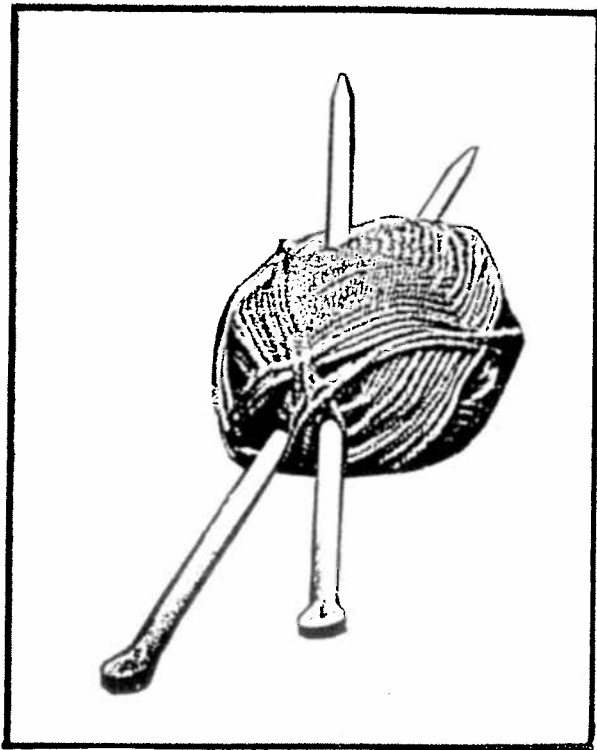

2

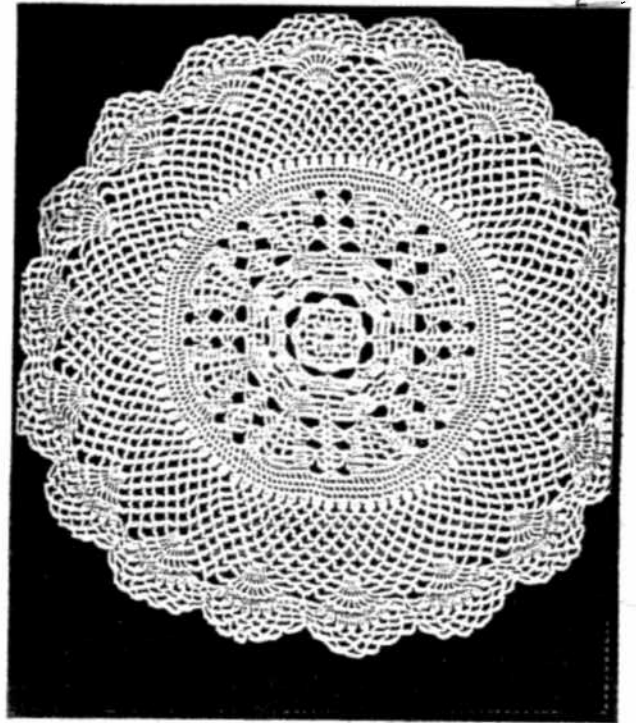

3

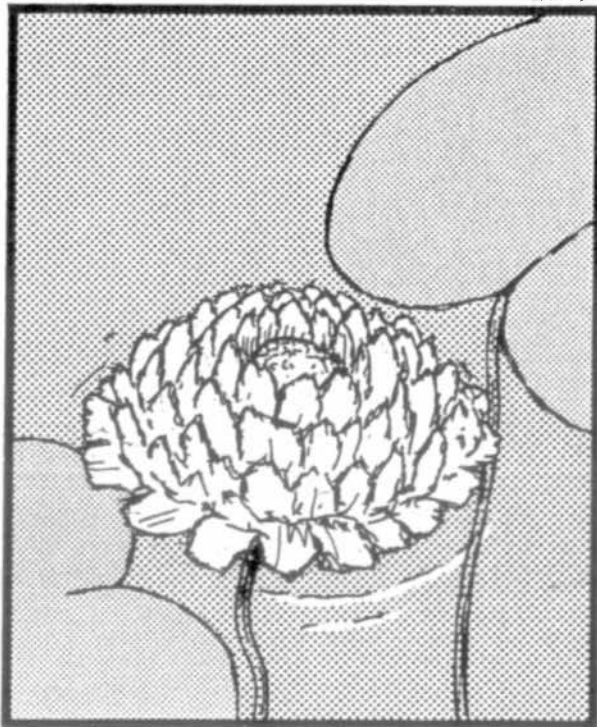

4

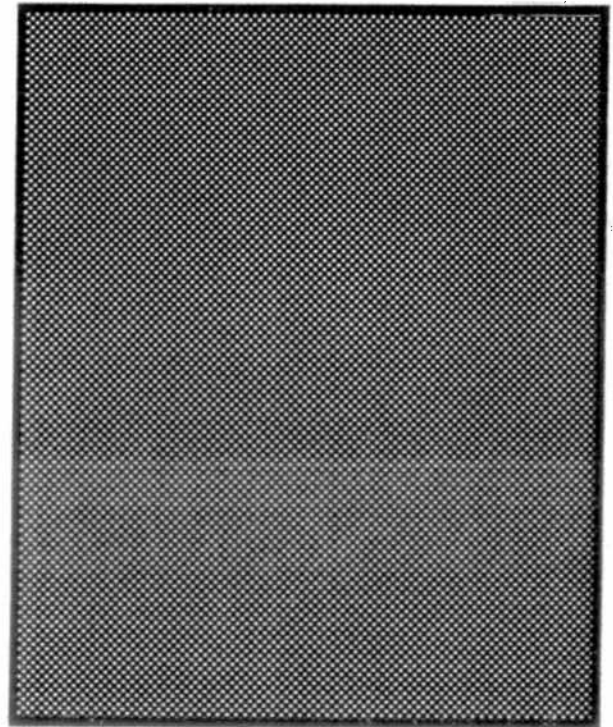

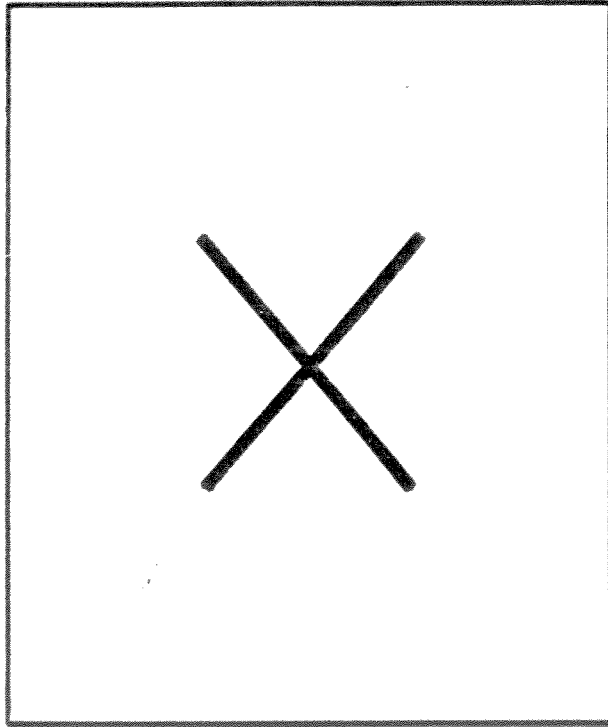

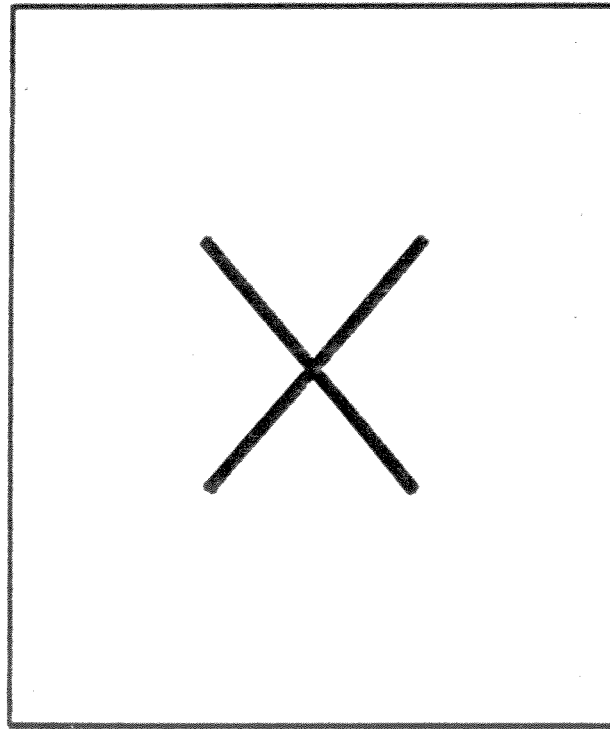



1

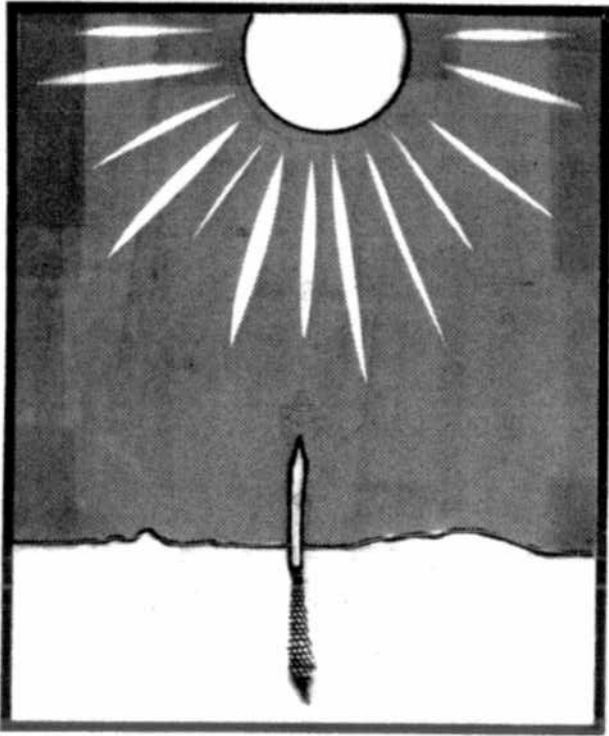

2



3

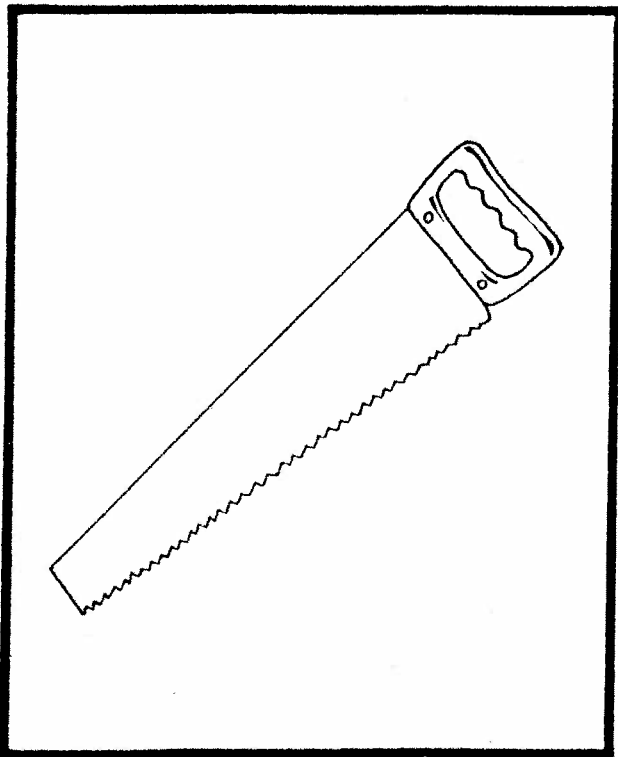

4

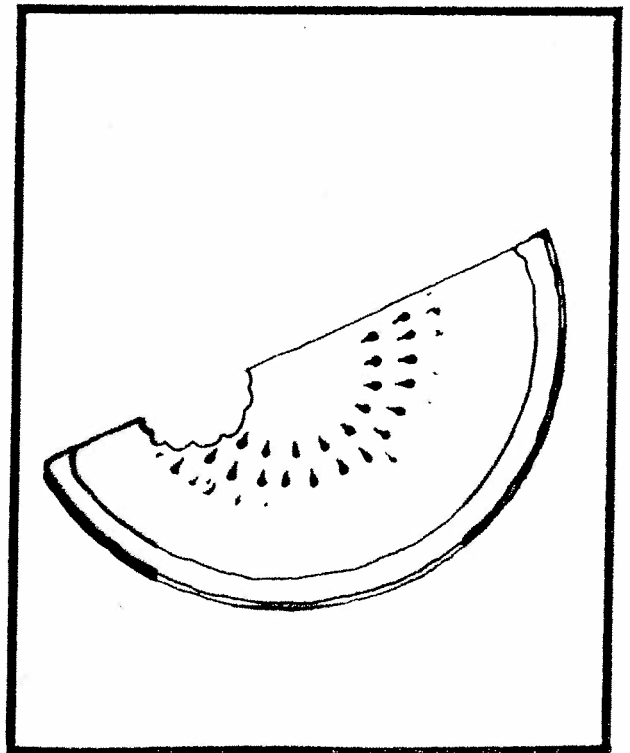

1

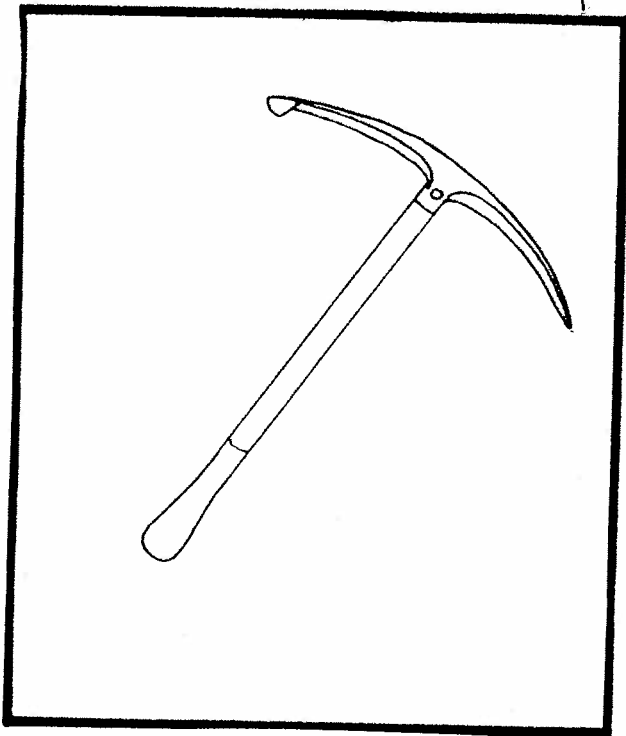

2

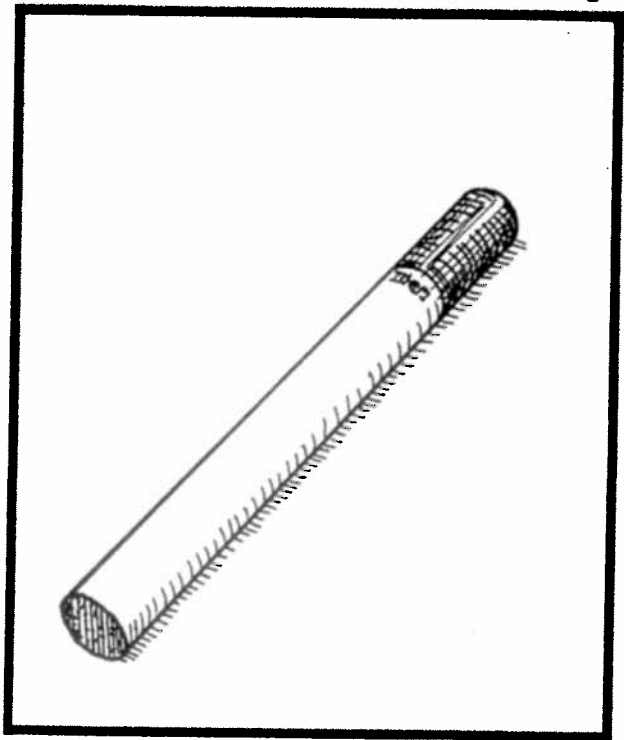

3

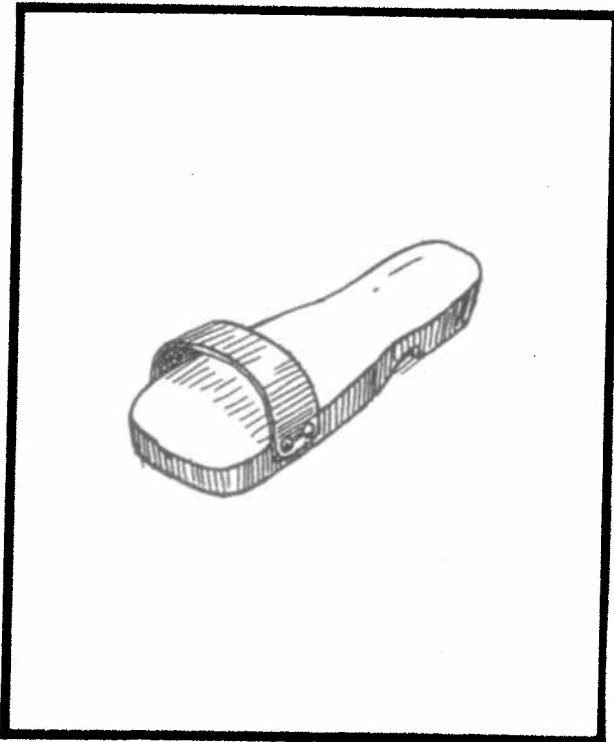

4

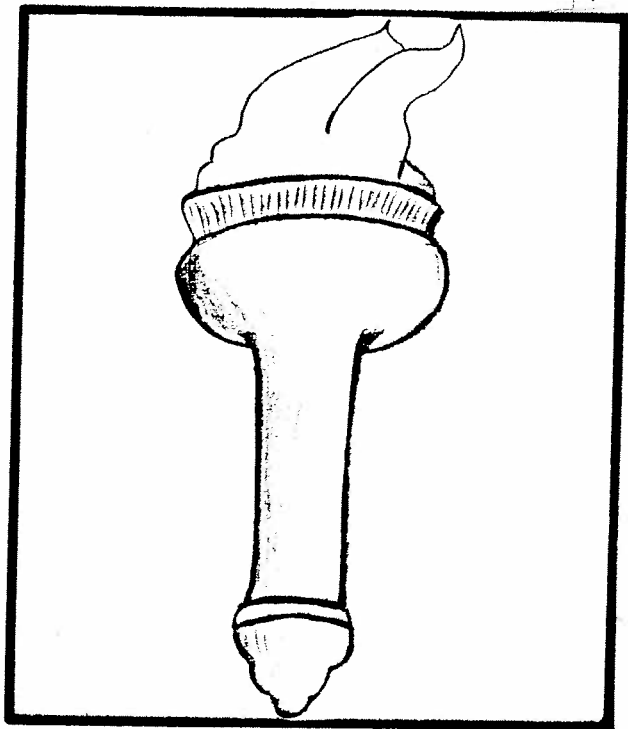

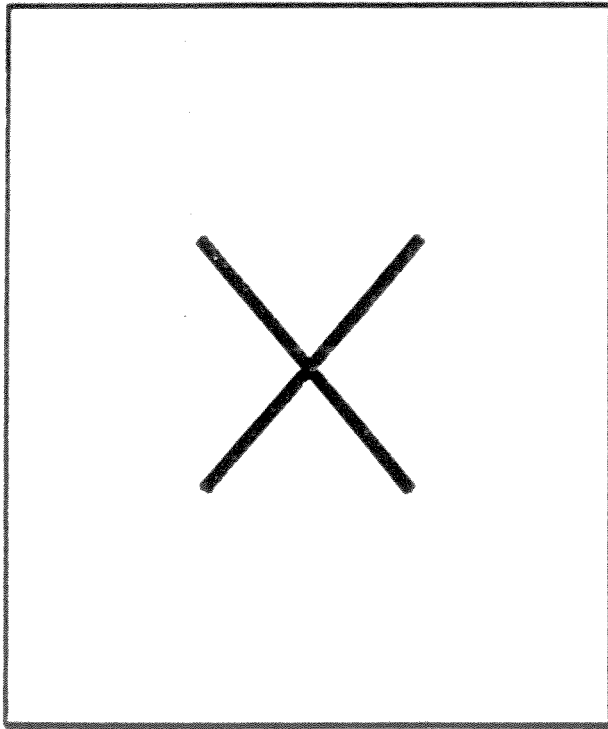

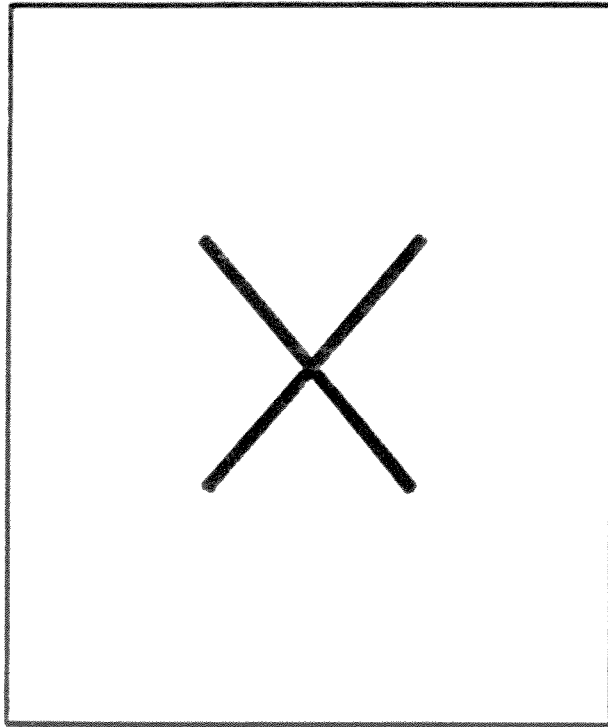

1



2

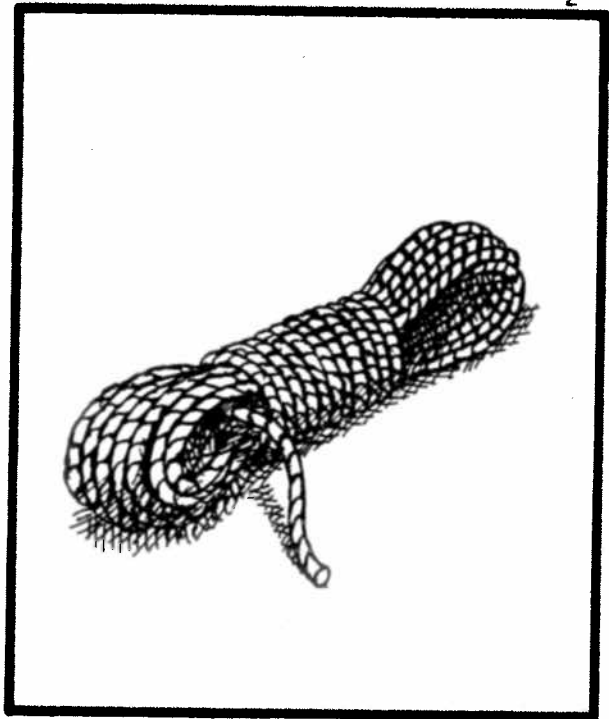

3

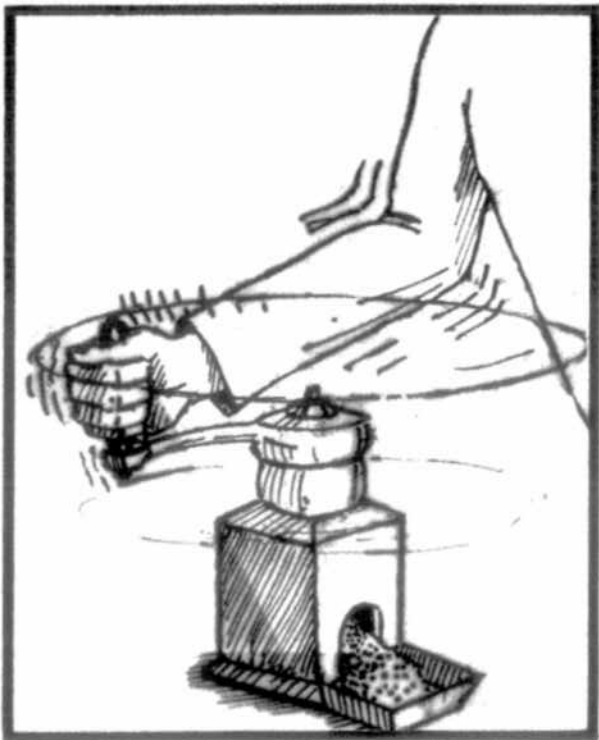

4

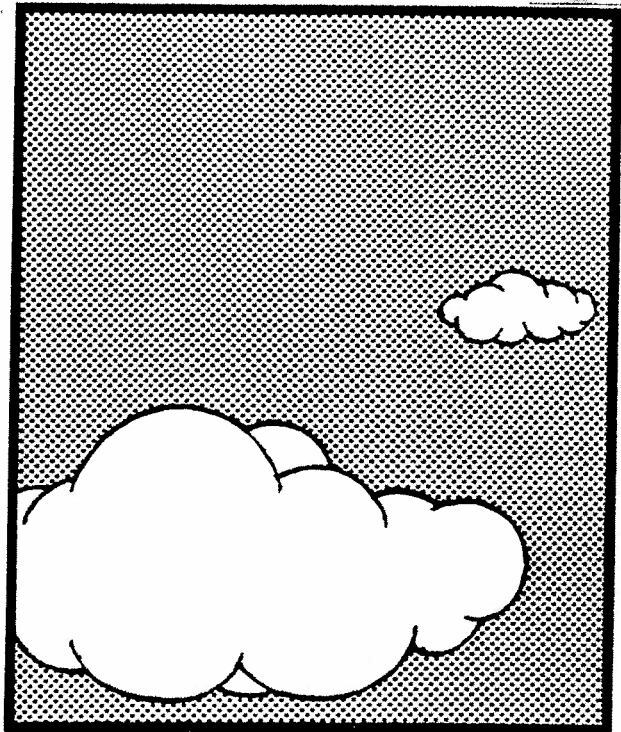

1



2

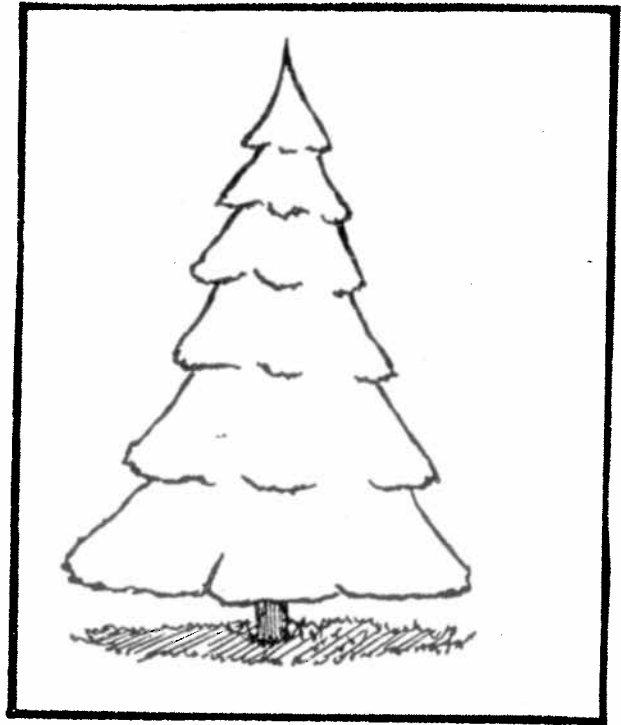

3

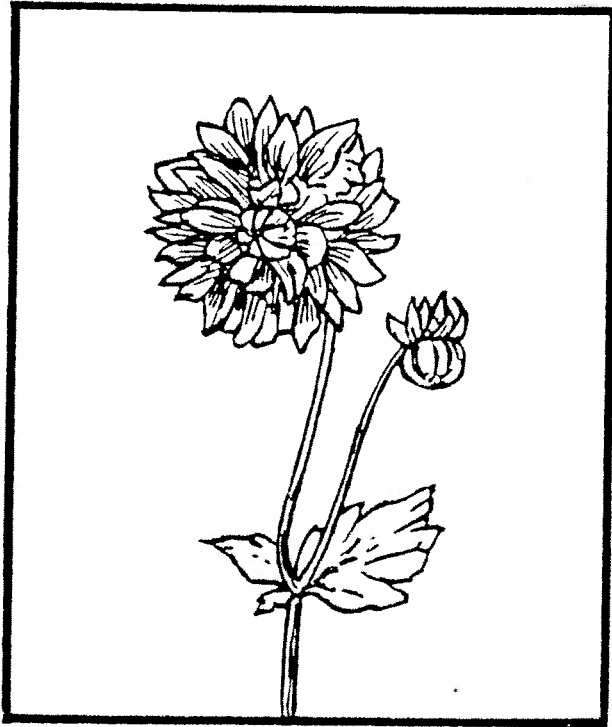

4



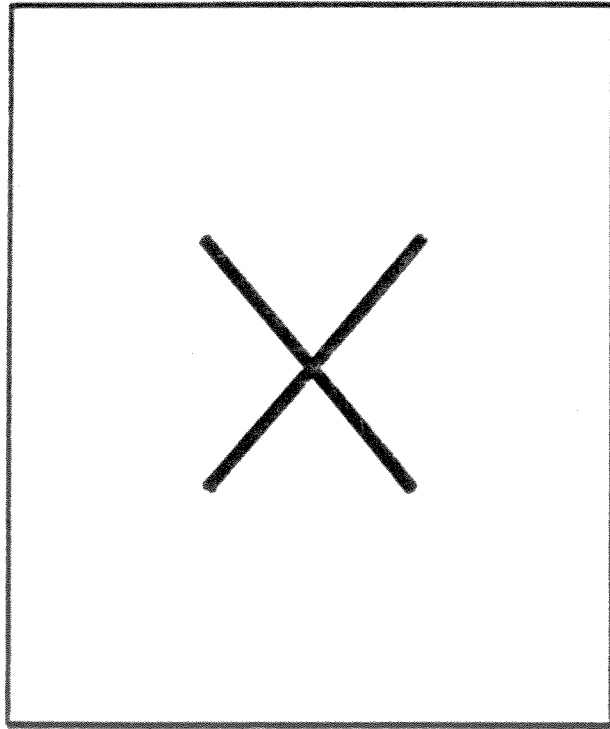

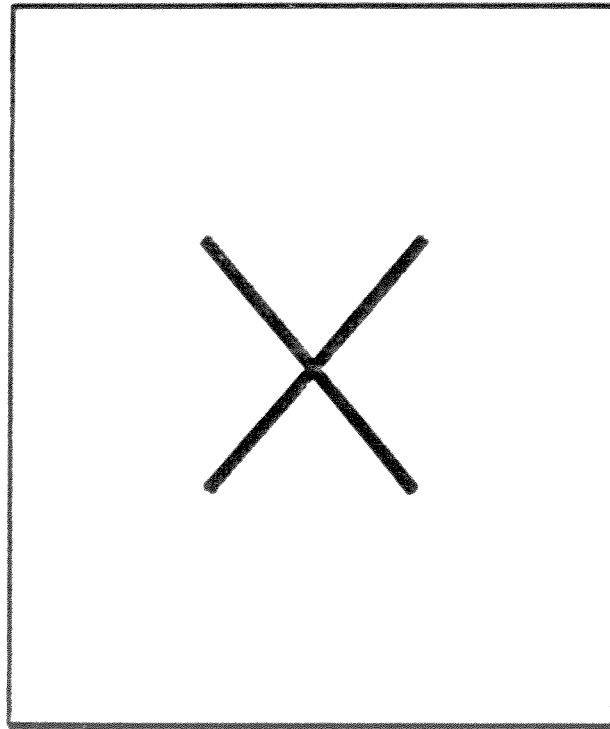



1

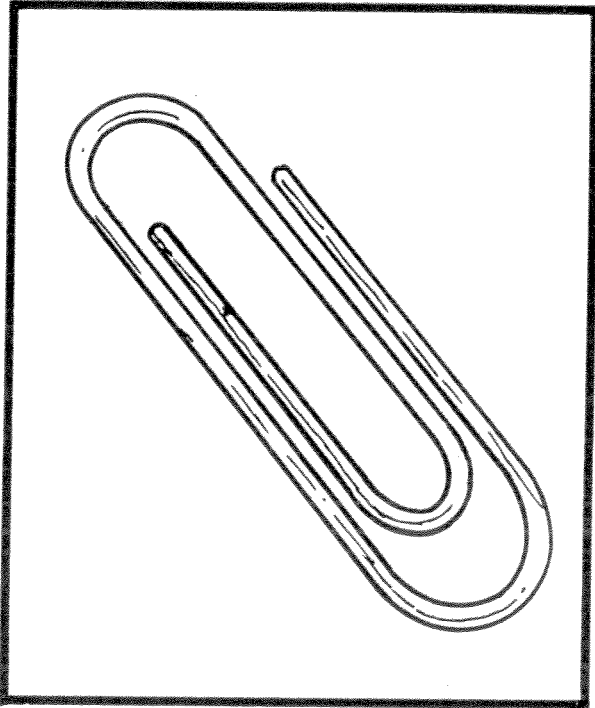

2

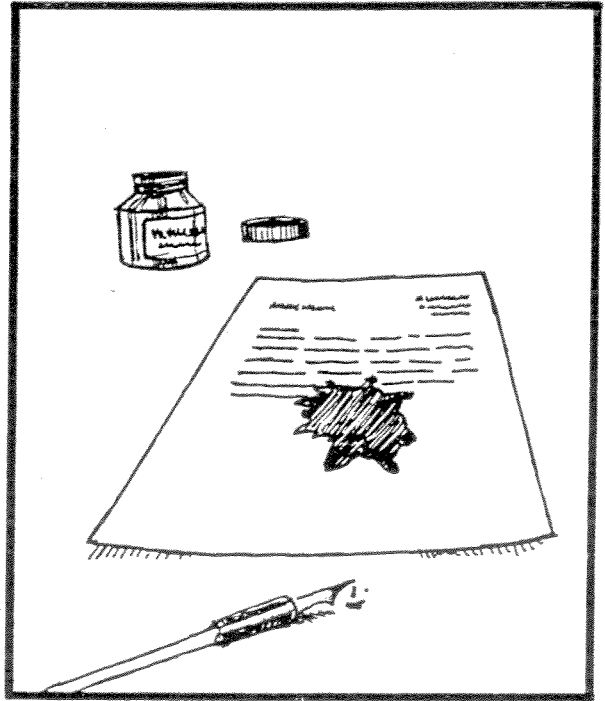

3



4

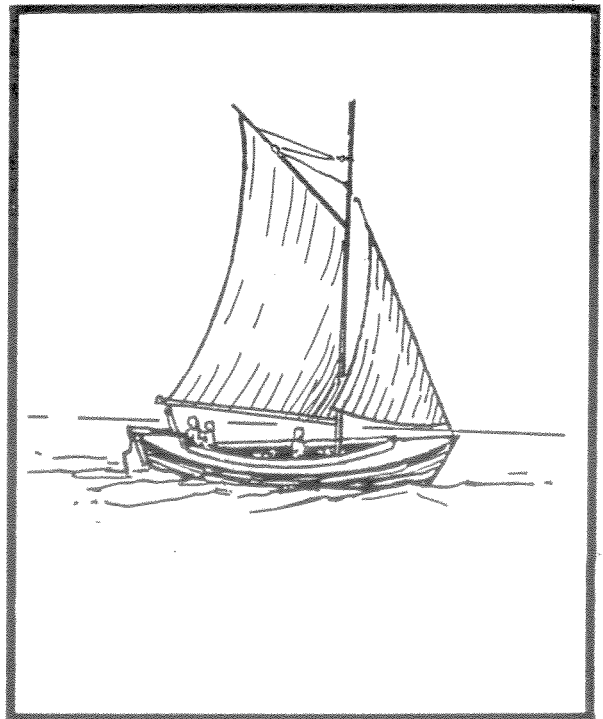

1

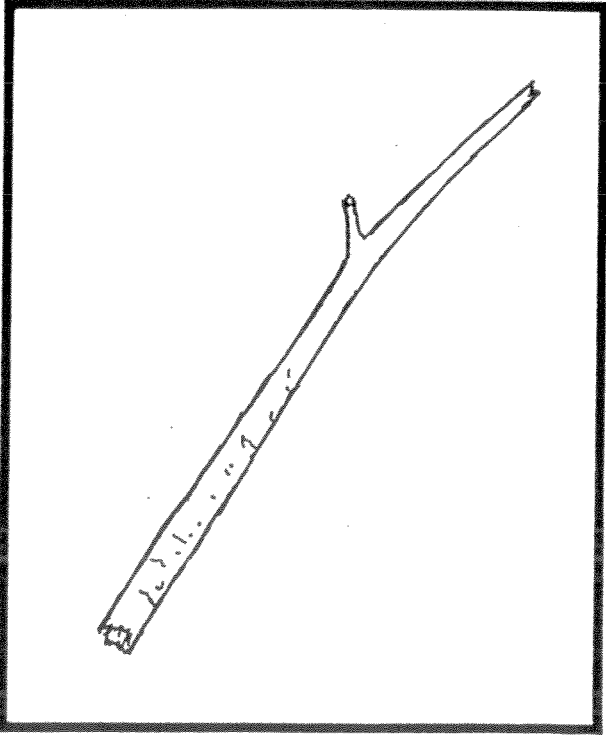

2

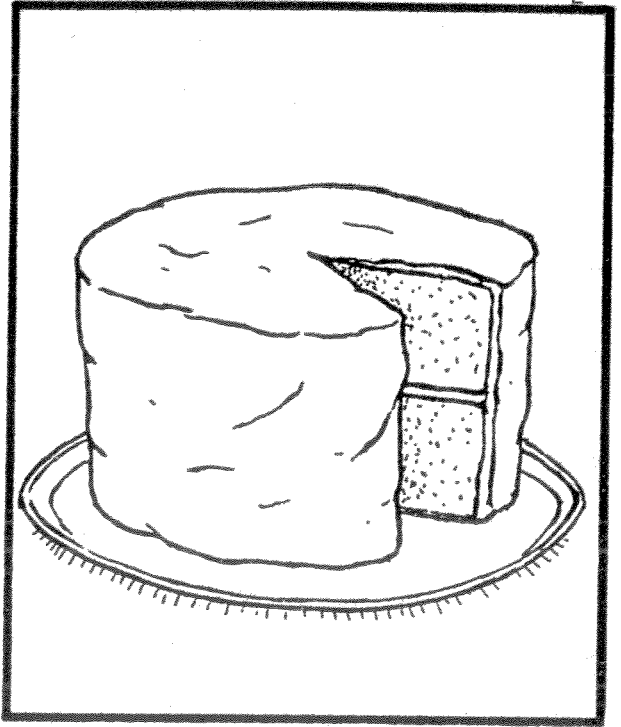

3

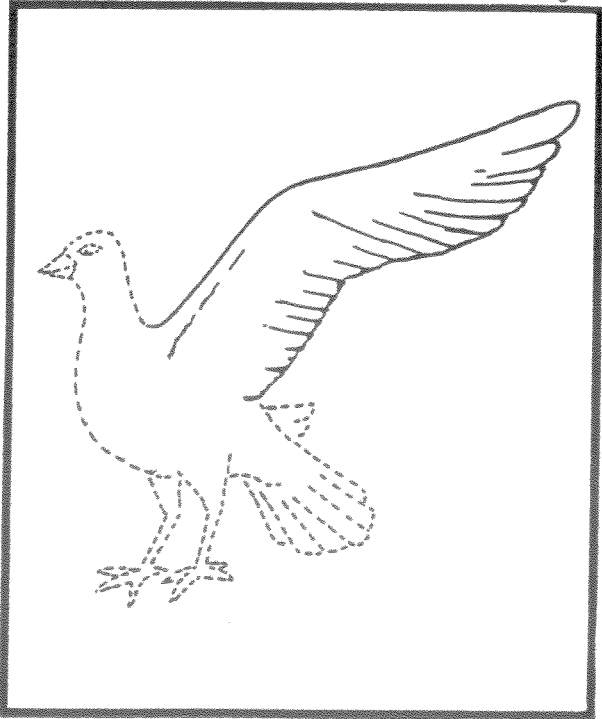

4

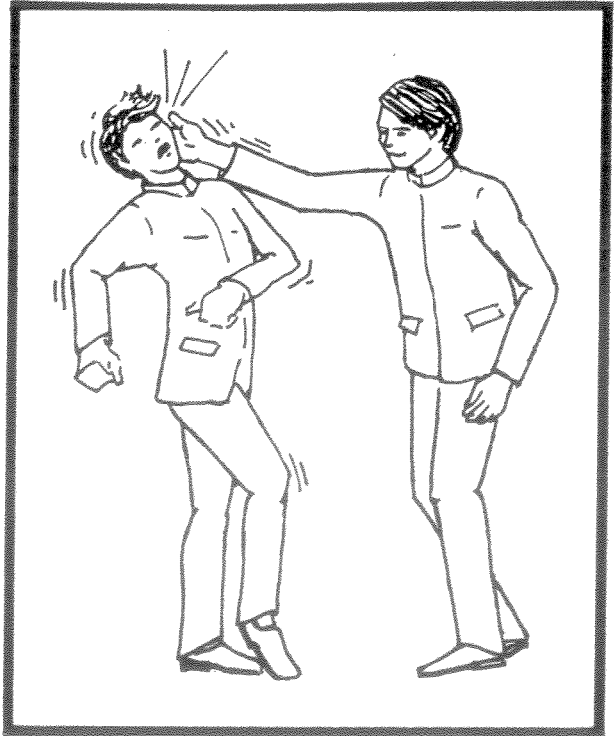

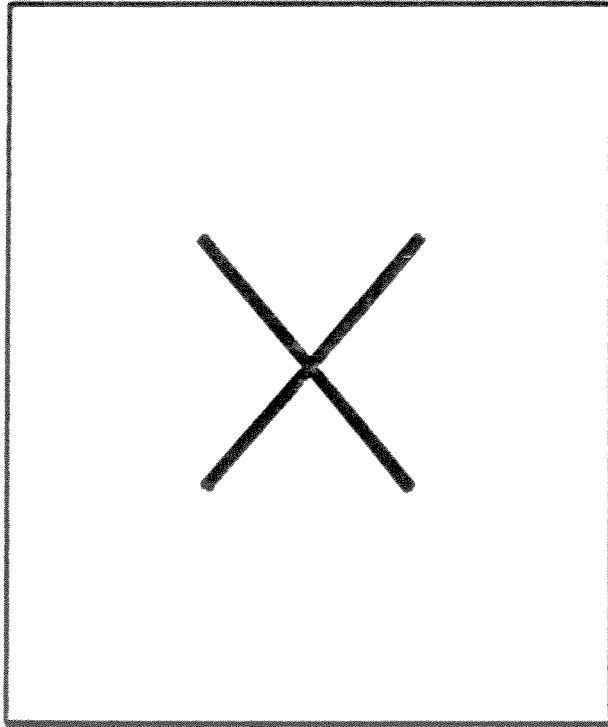

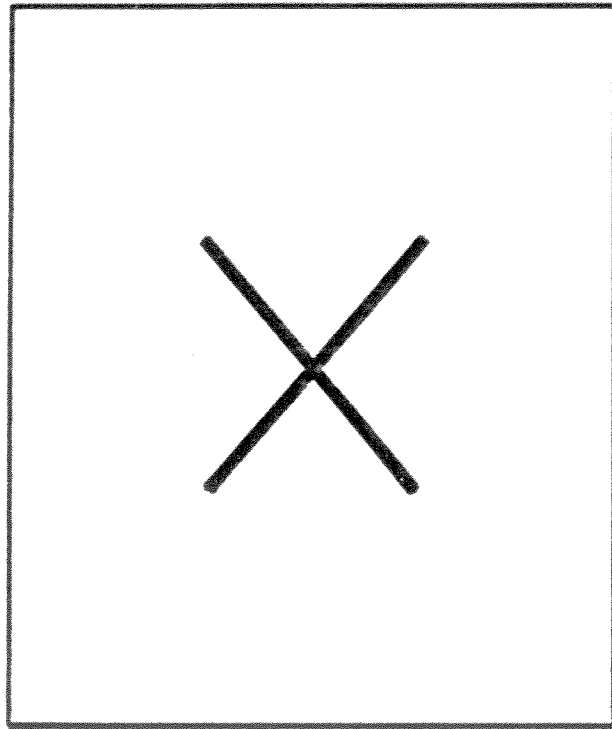

1

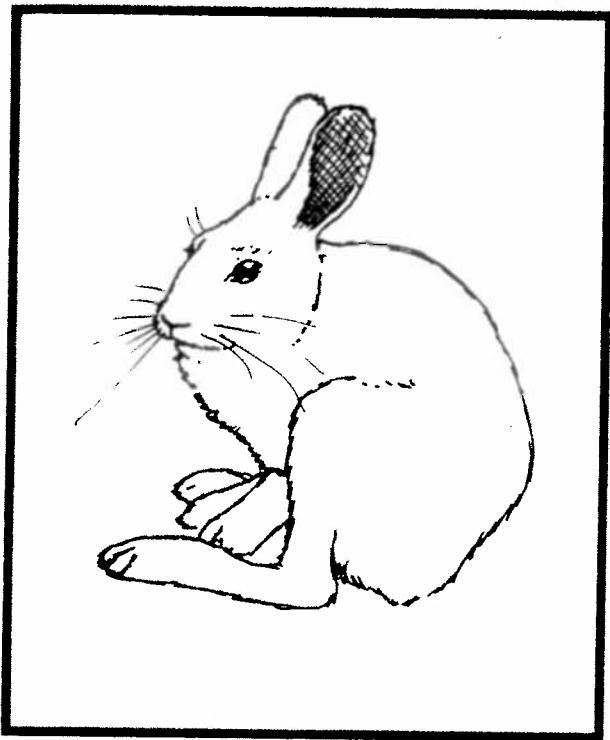

2

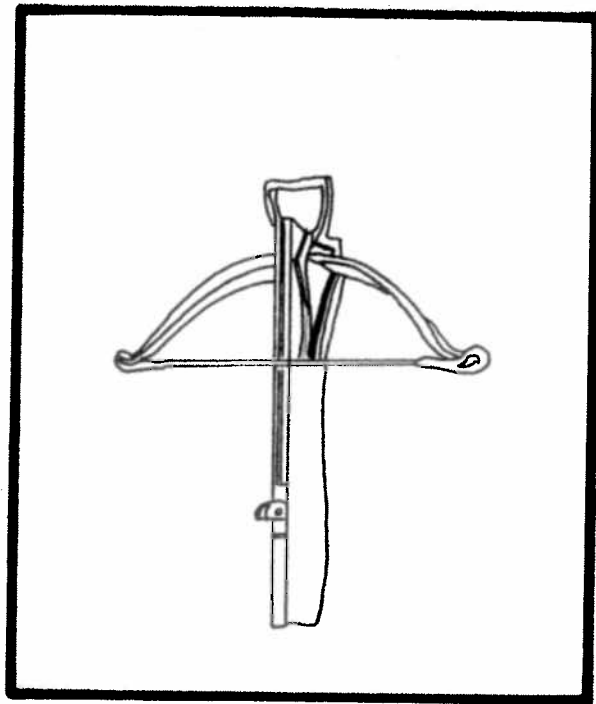

3



4

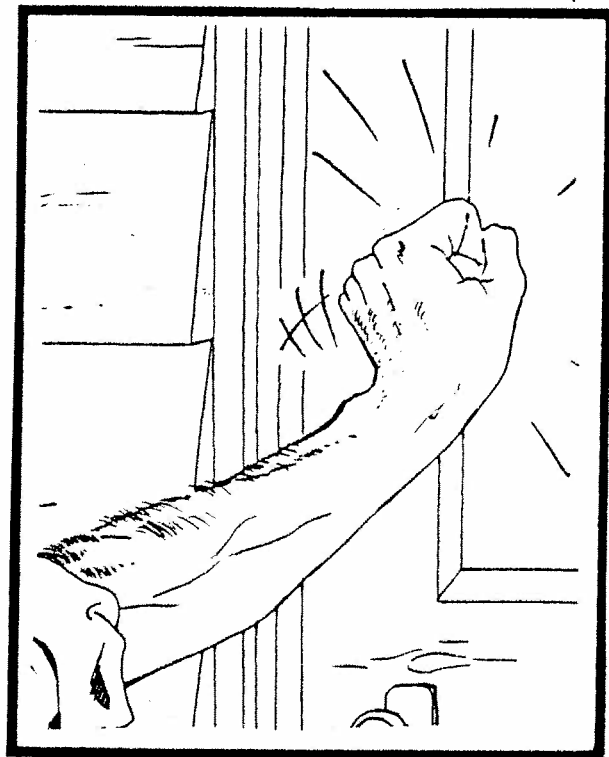

1

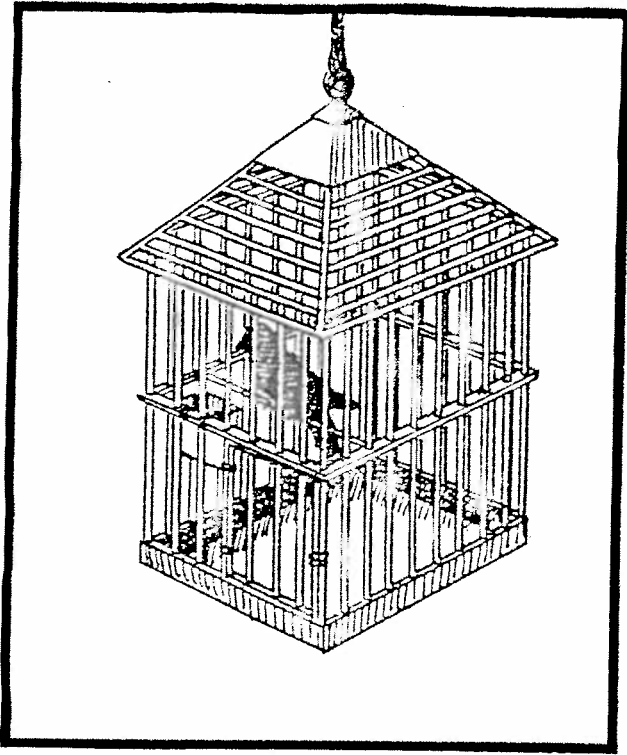

2

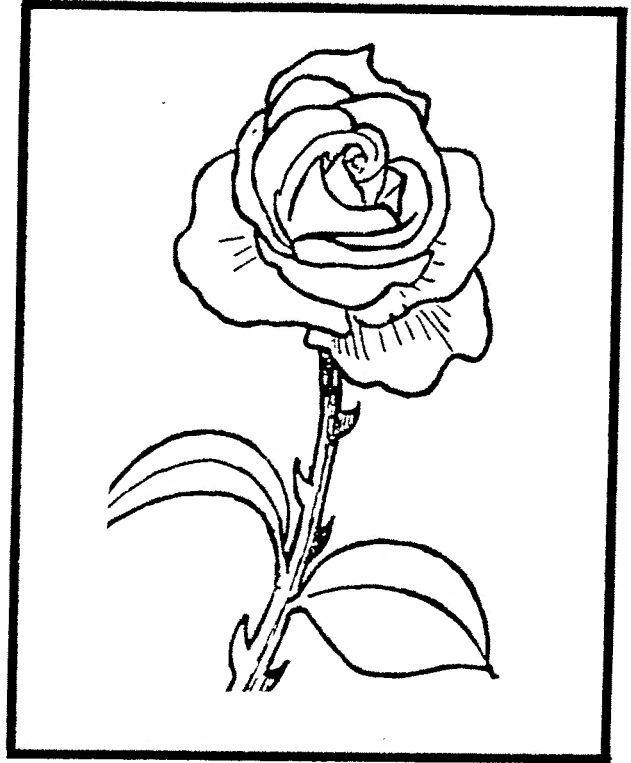

3

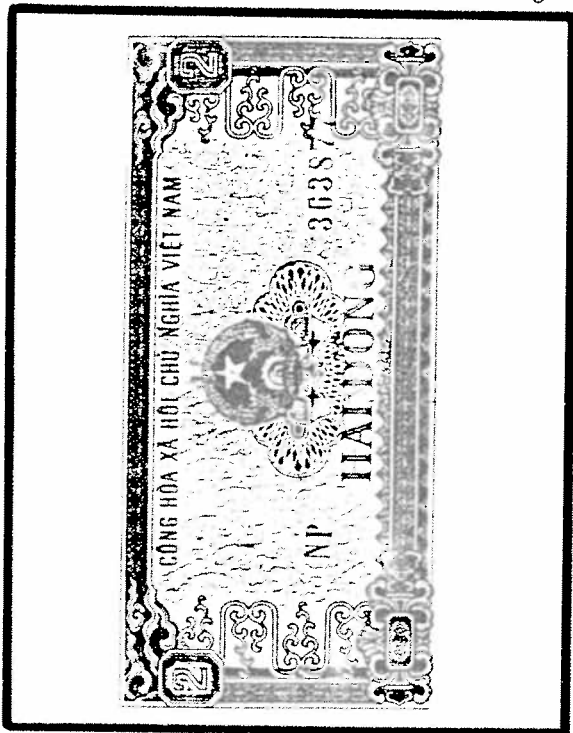

4



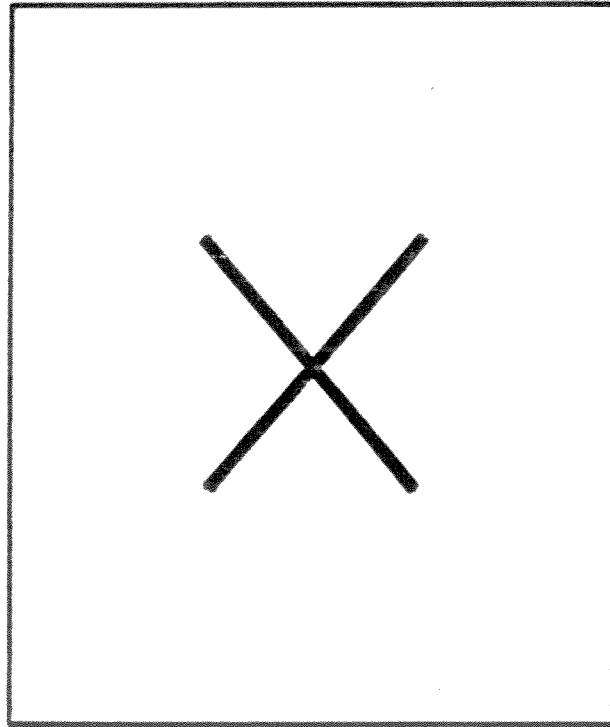

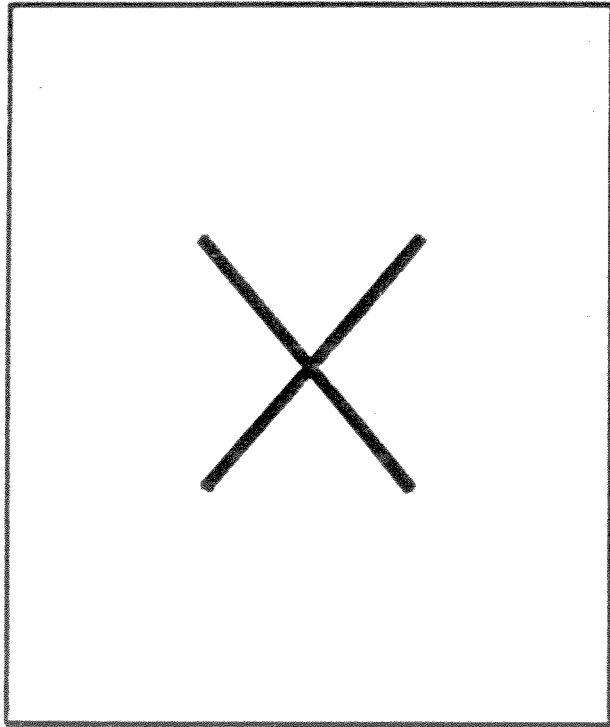



1

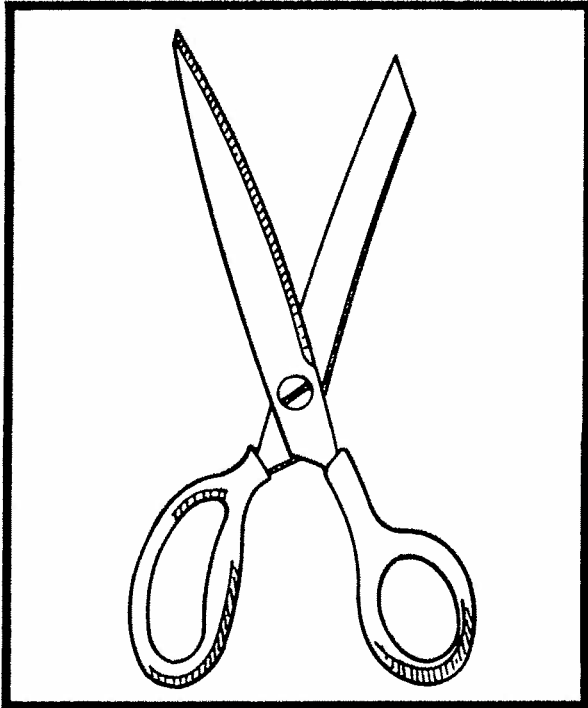

2

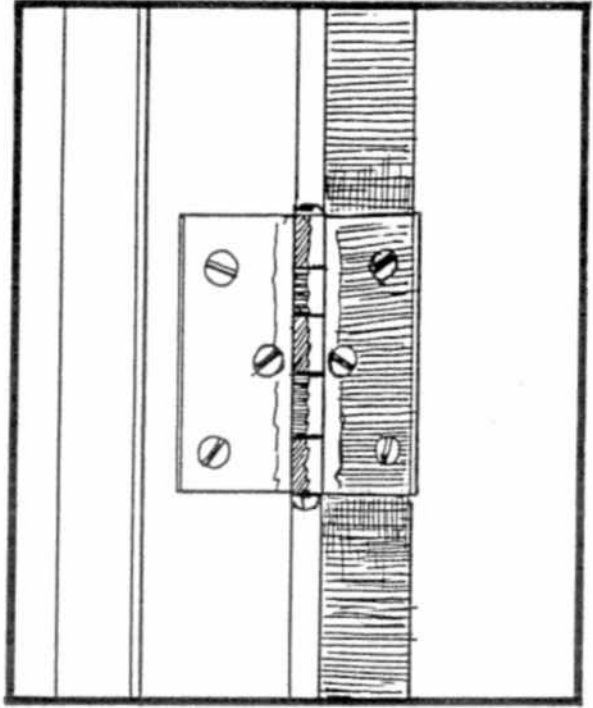

3

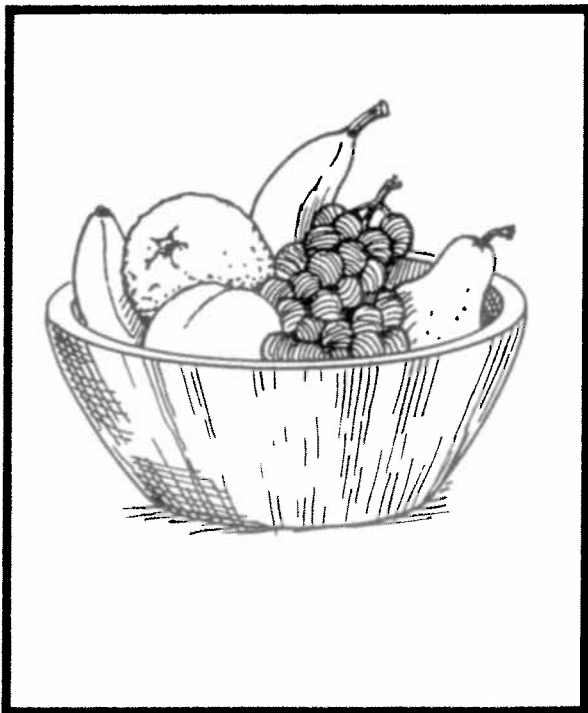

4

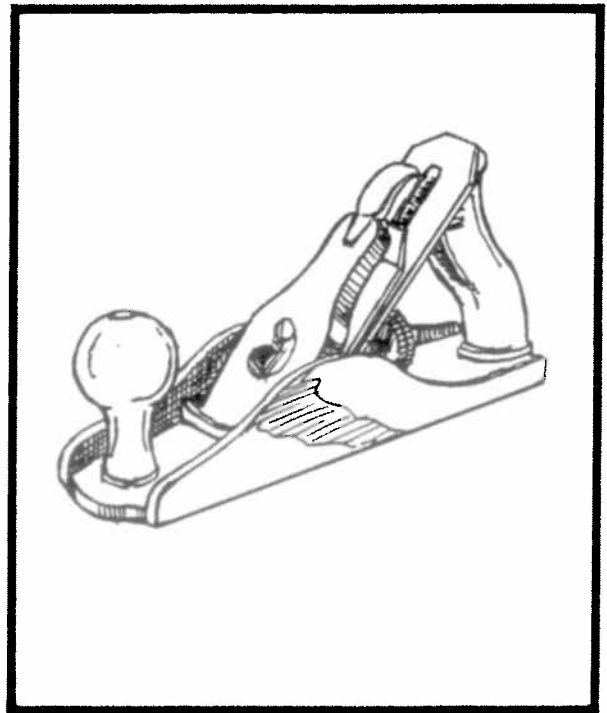

1

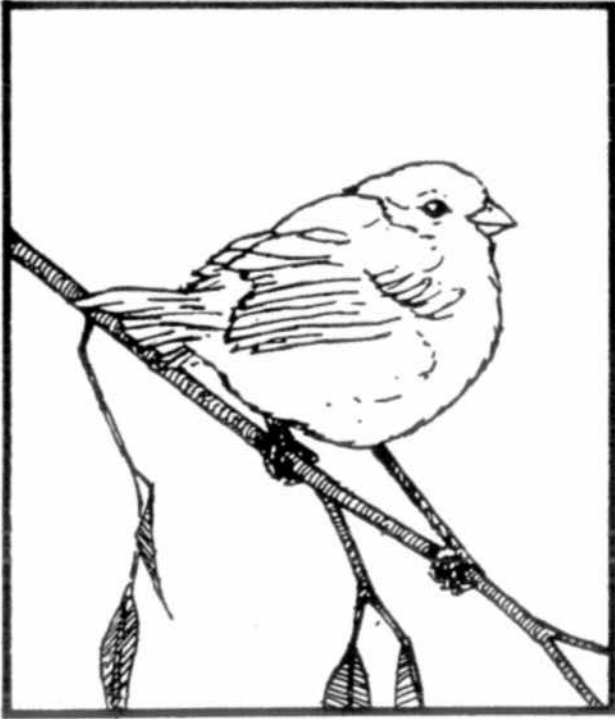

2

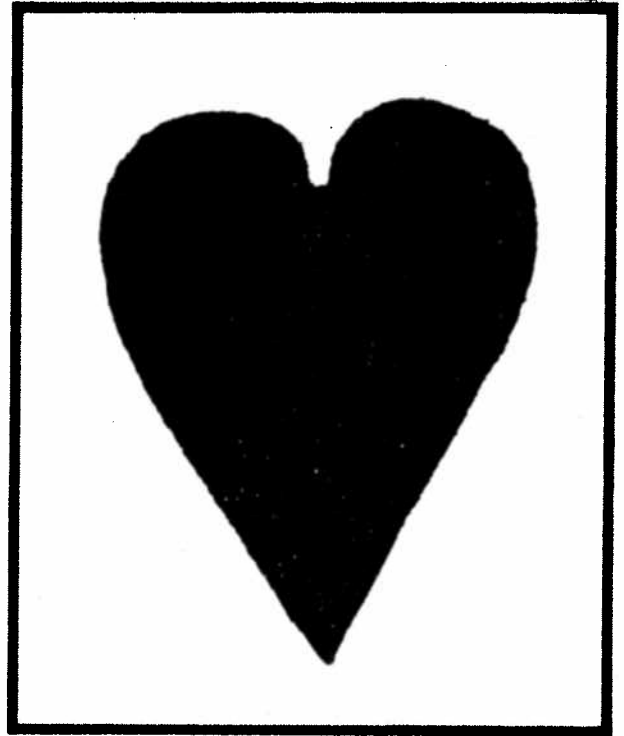

3

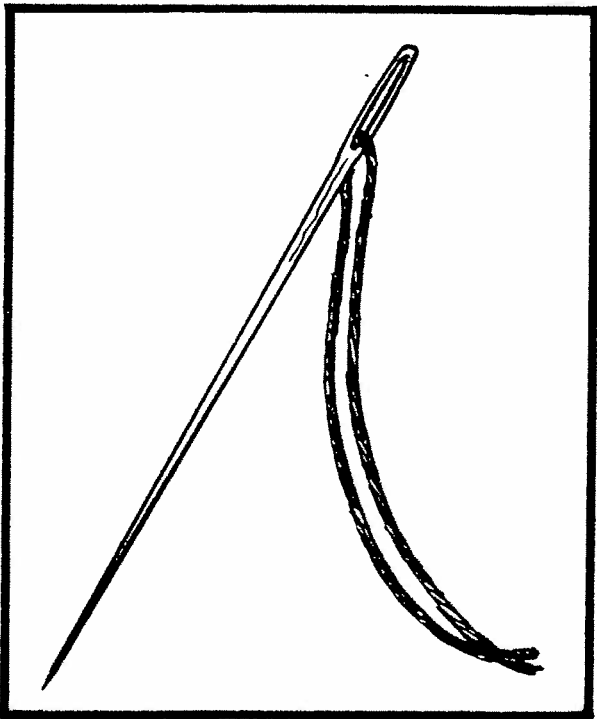

4

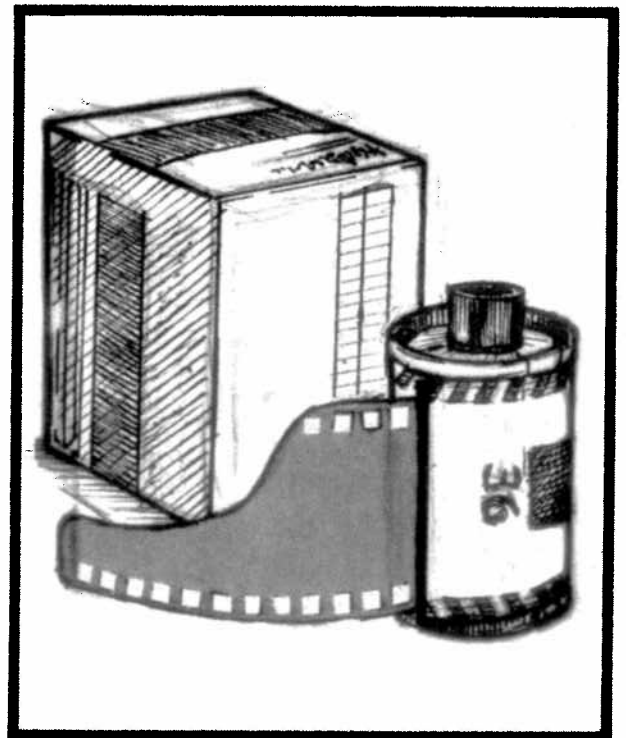

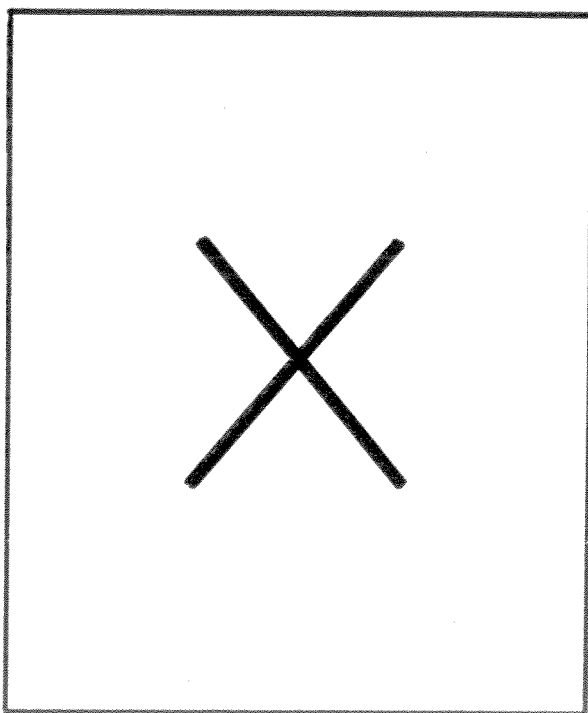

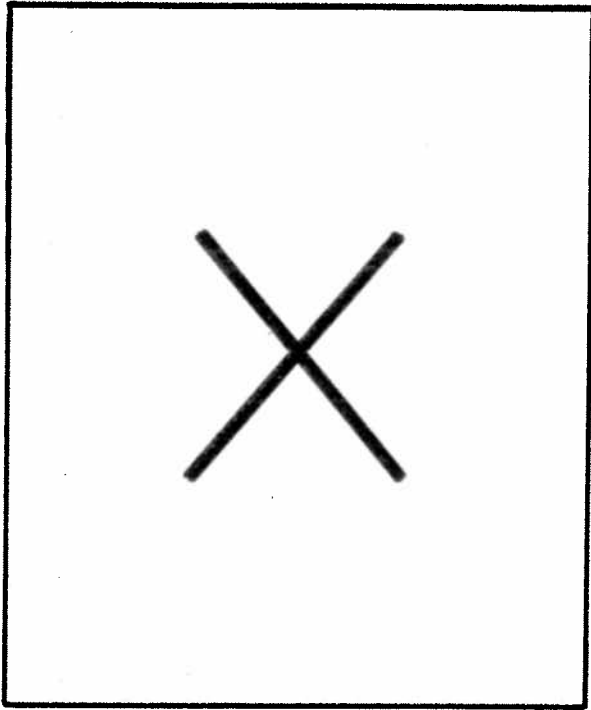

1



2

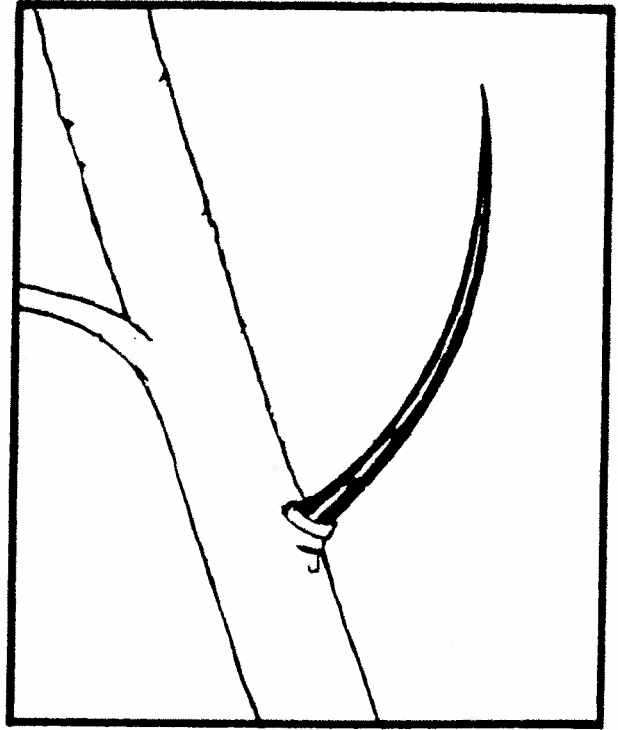

3

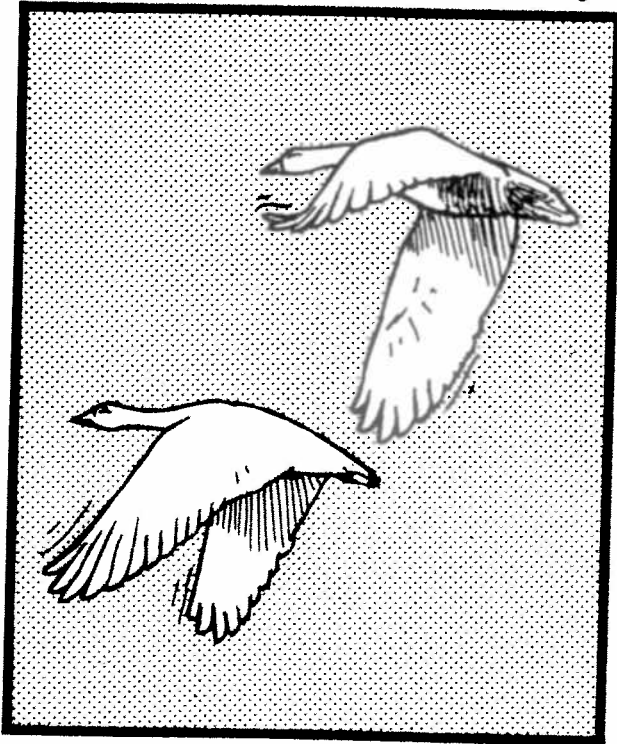

4



1

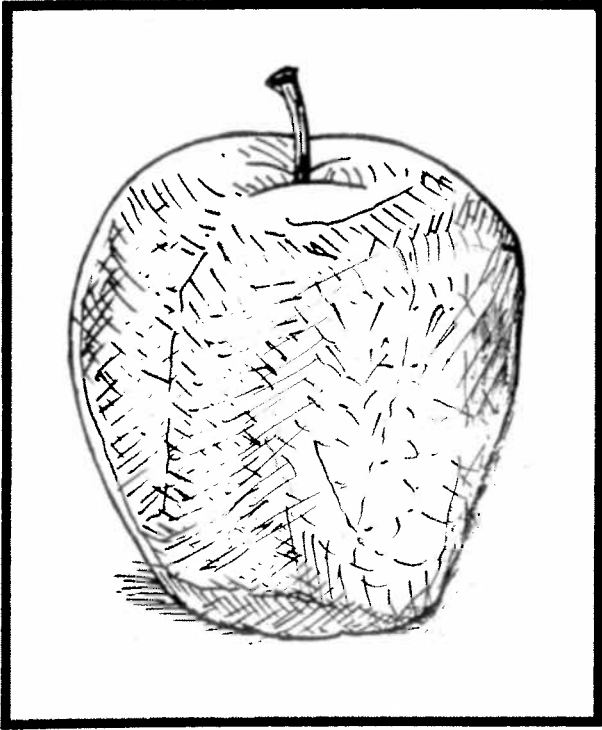

2

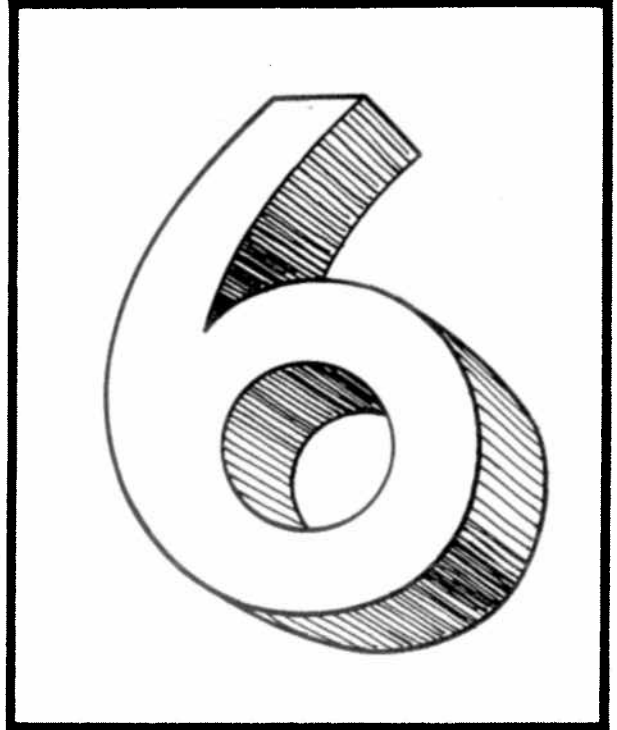

3



4

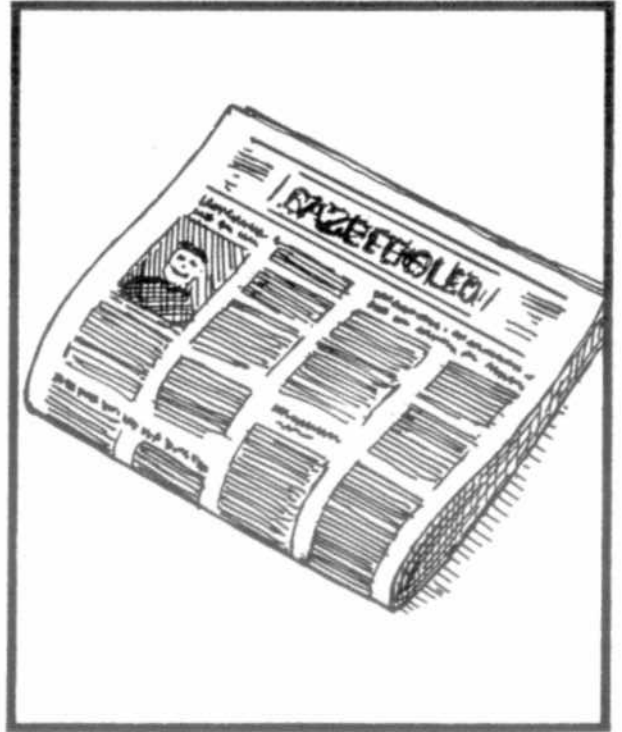

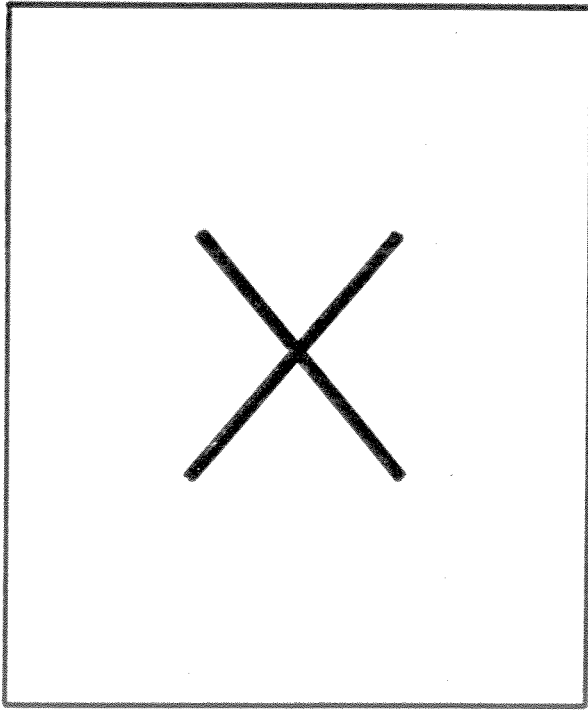

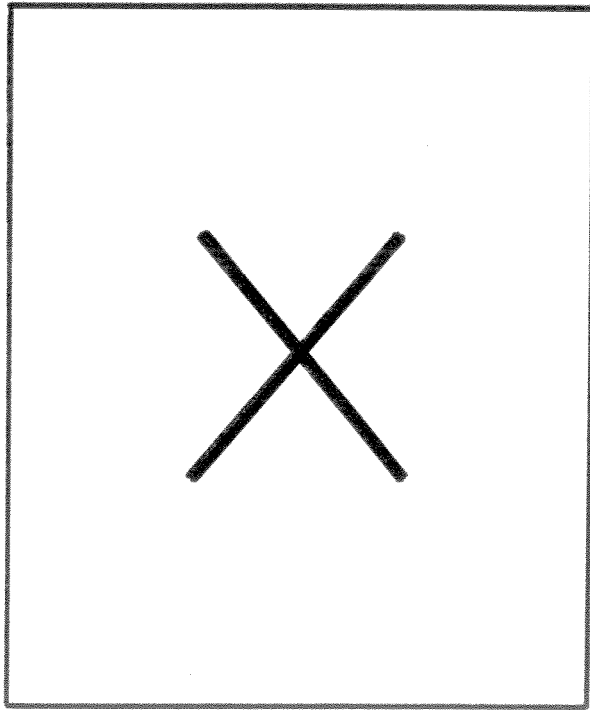



1



2

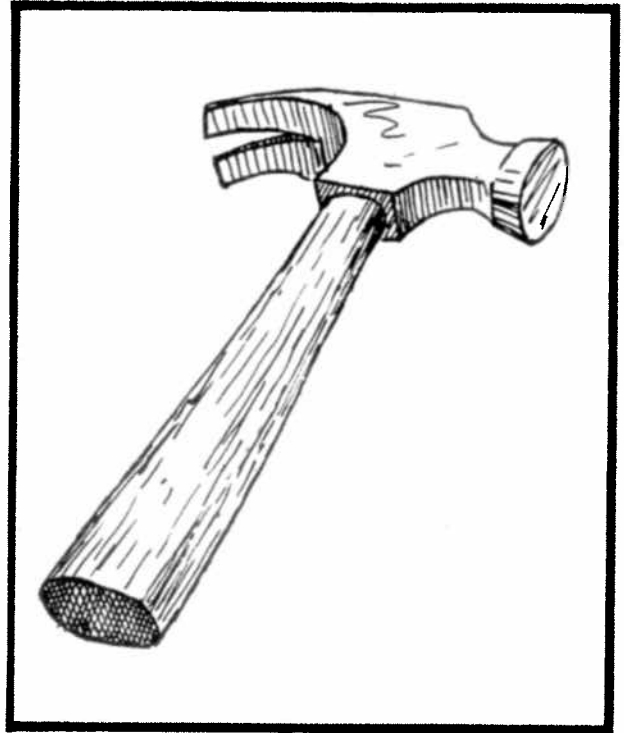

3



4

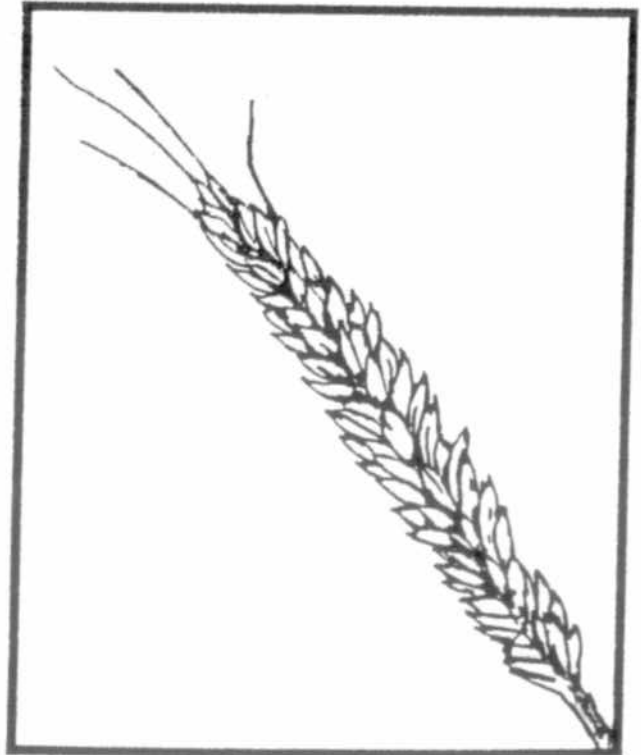



HÌNH DÀNH CHO PHẦN  
HIỂU BIẾT CÁC CƠ CẤU CỤ PHÁP

1

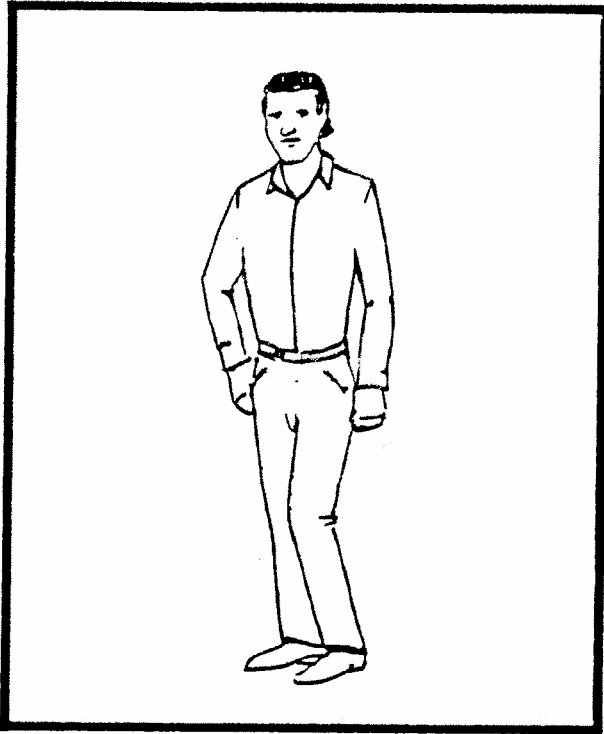

2

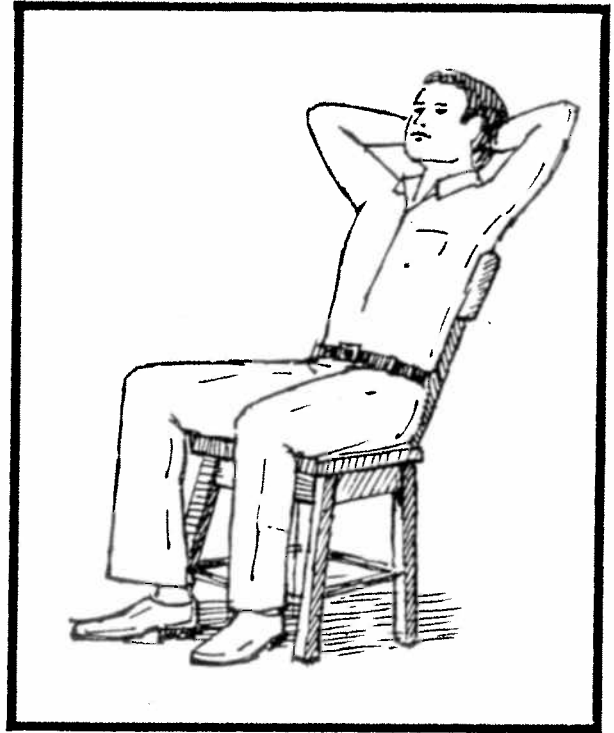

3

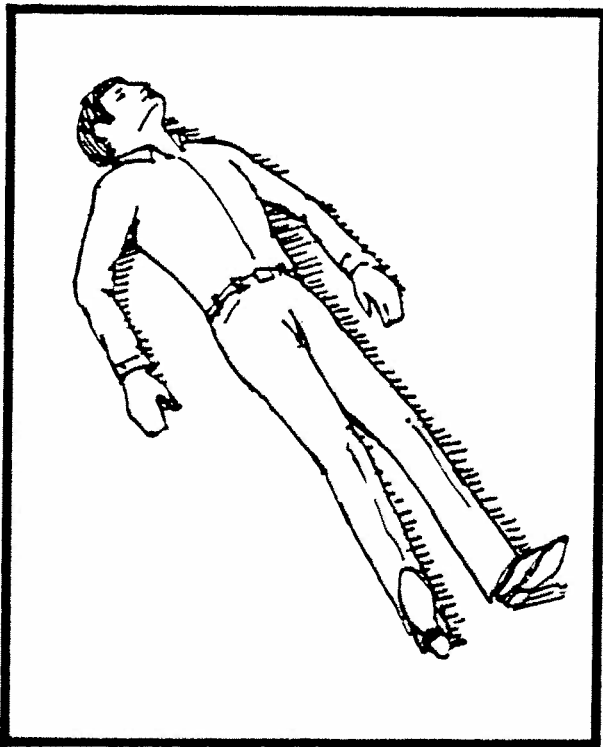

4



Ví dụ

1

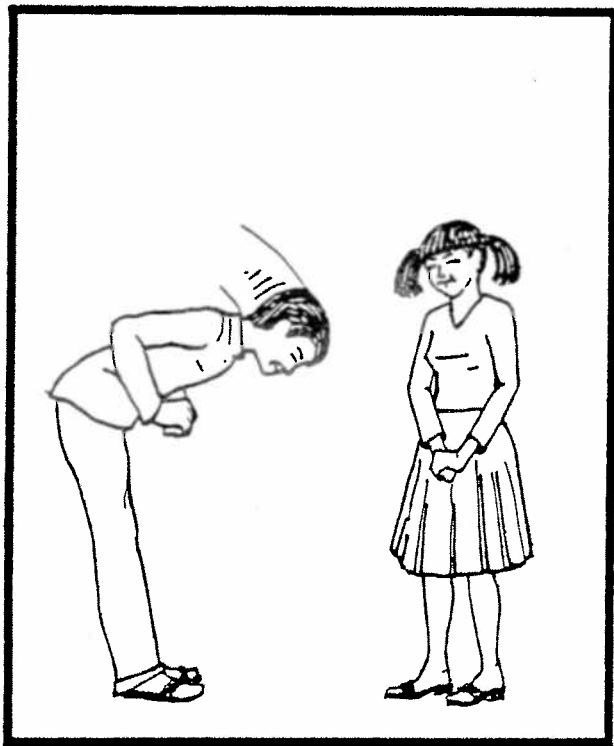

2

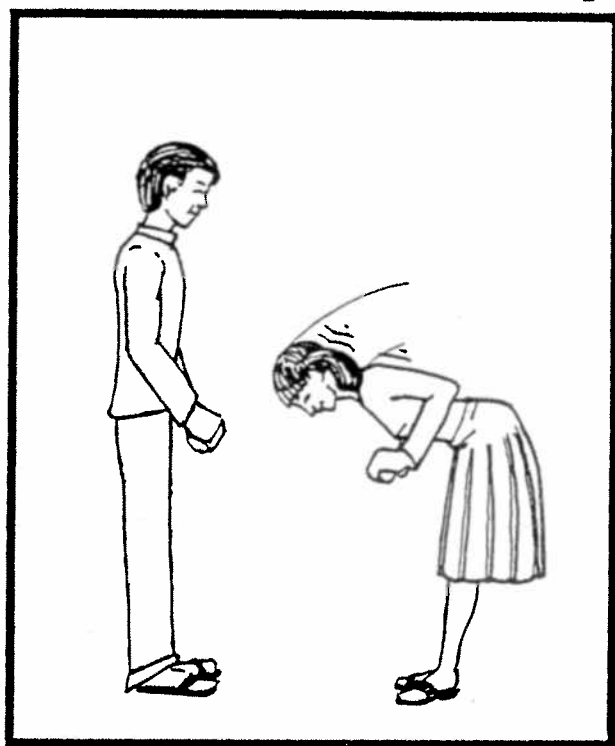

3

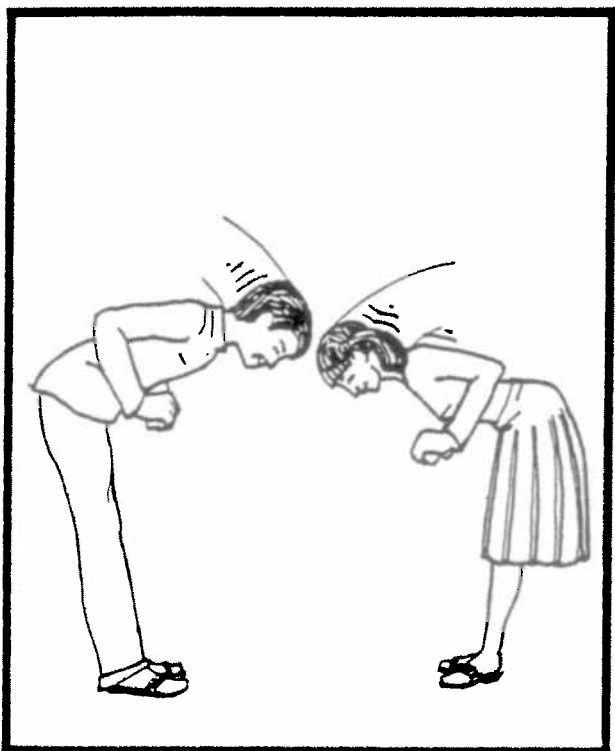

4

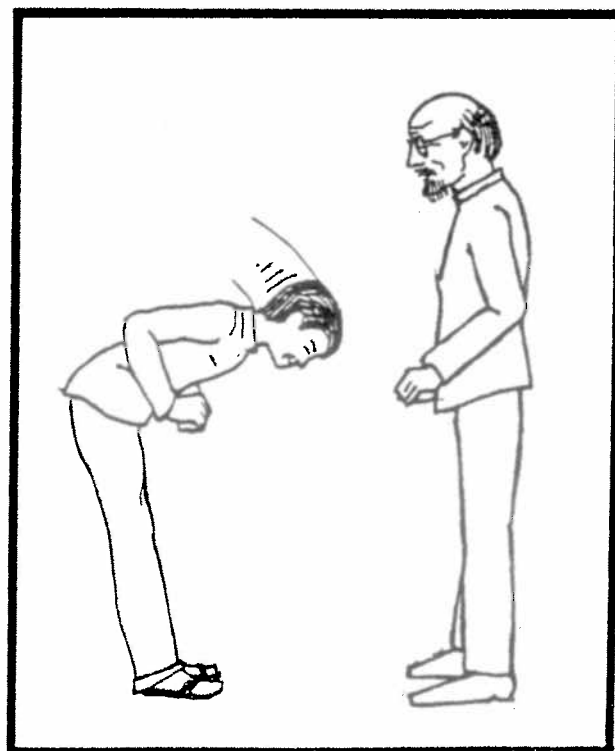

1



2

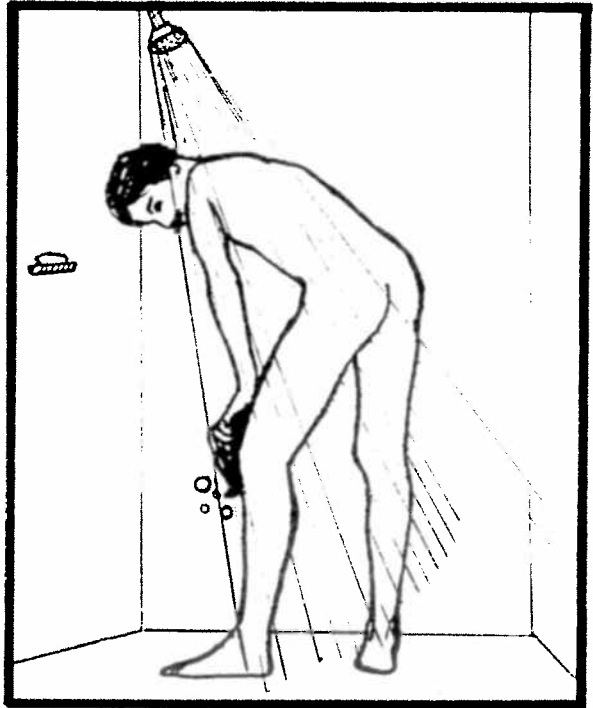

3

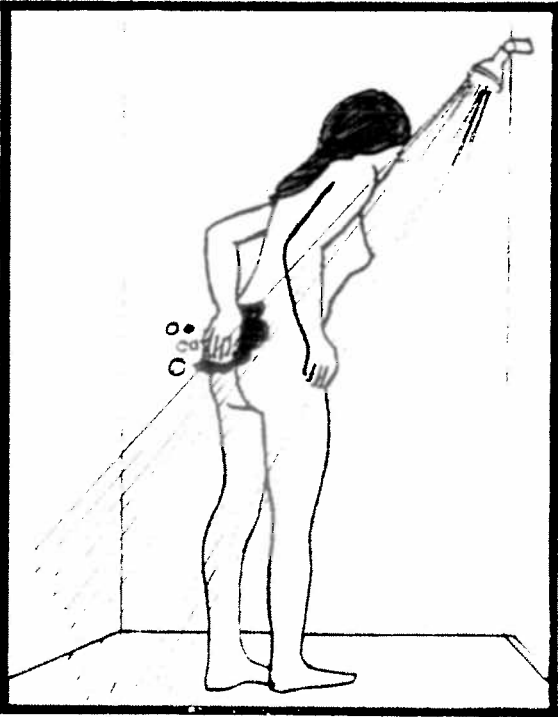

4



1



2

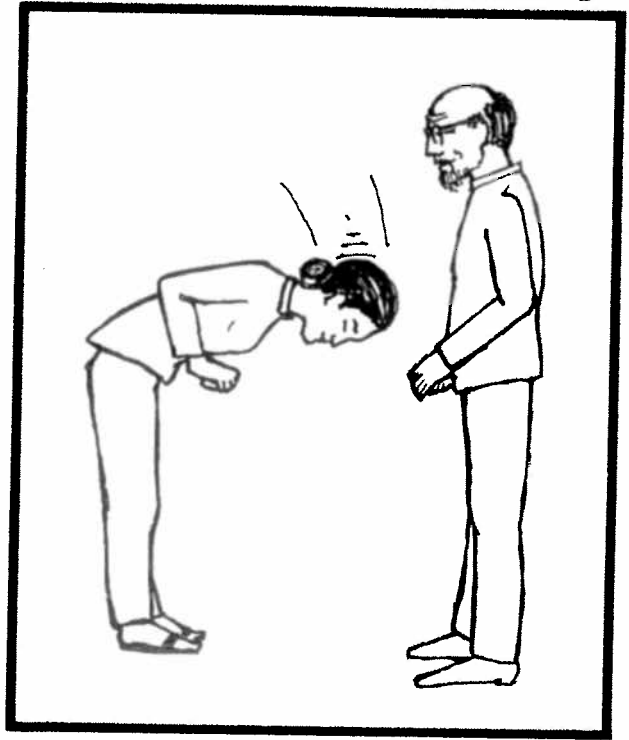

3

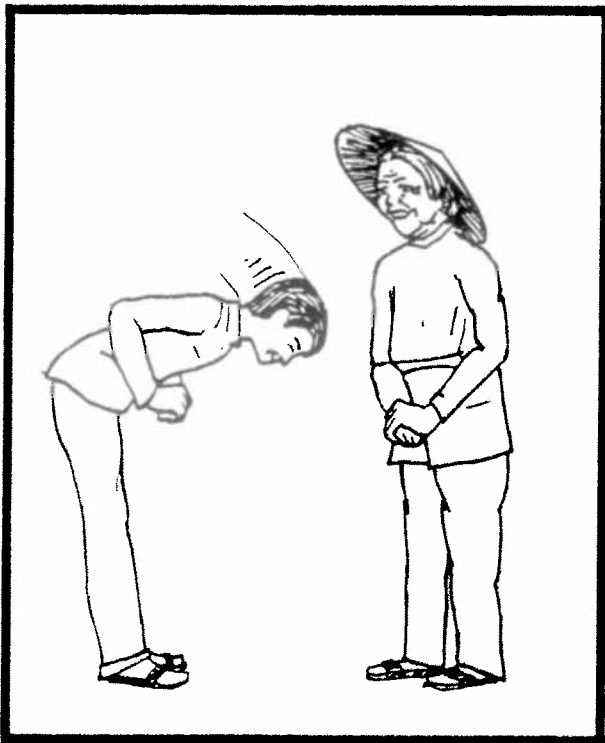

4

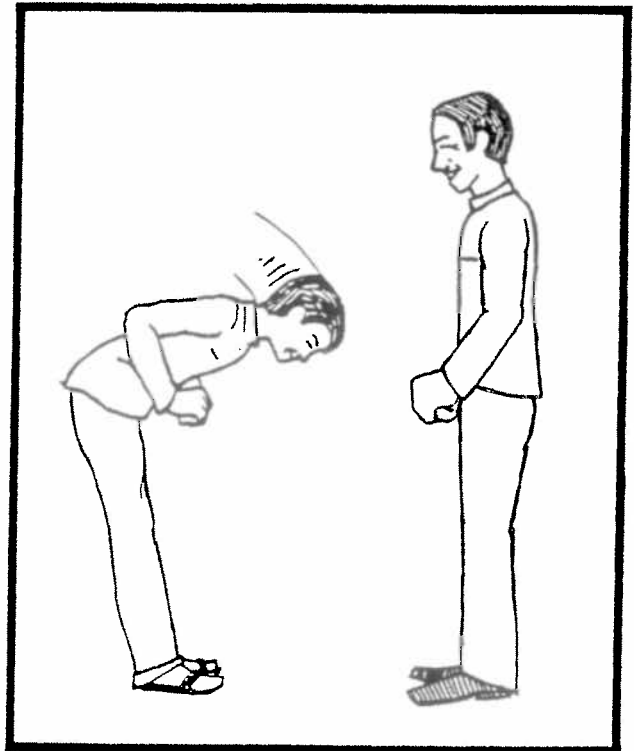

1

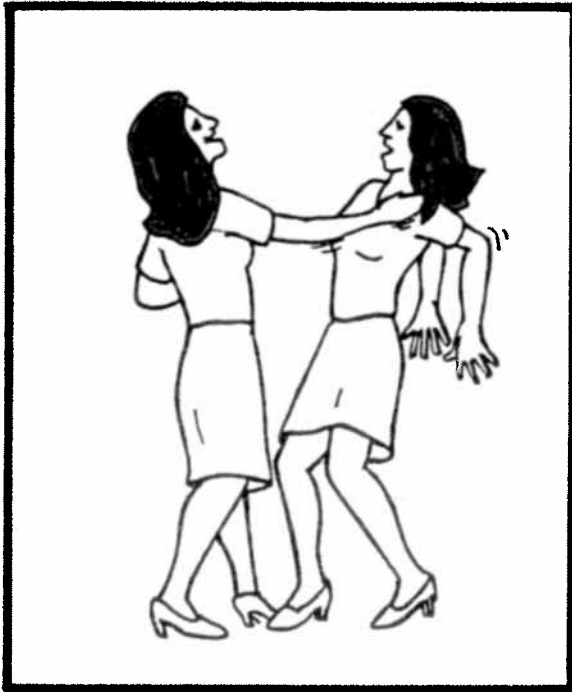

2

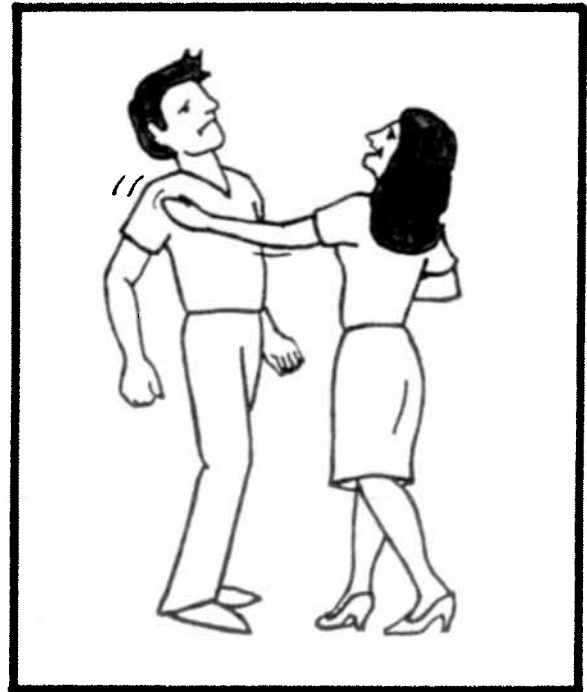

3

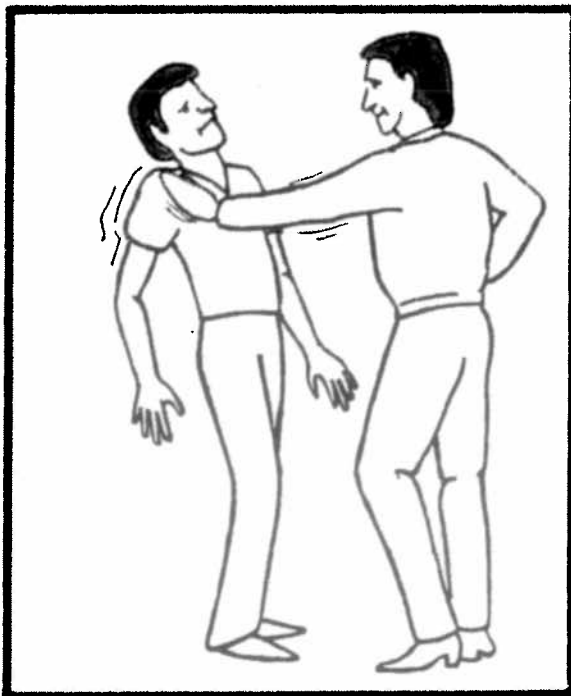

4

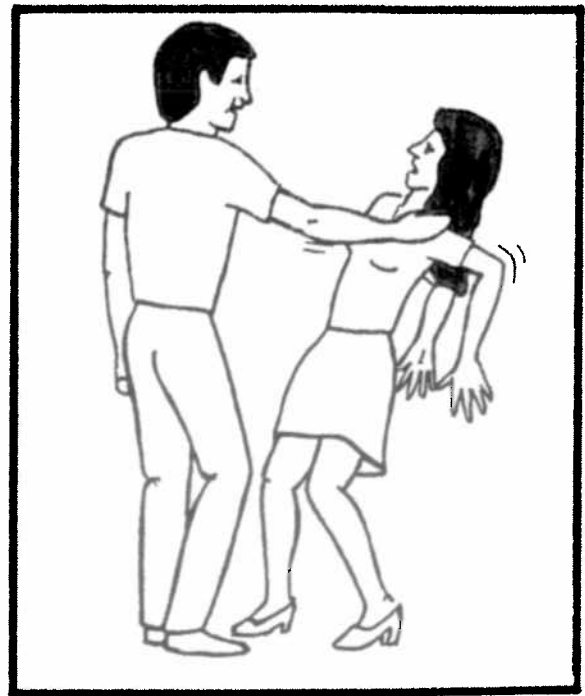



1

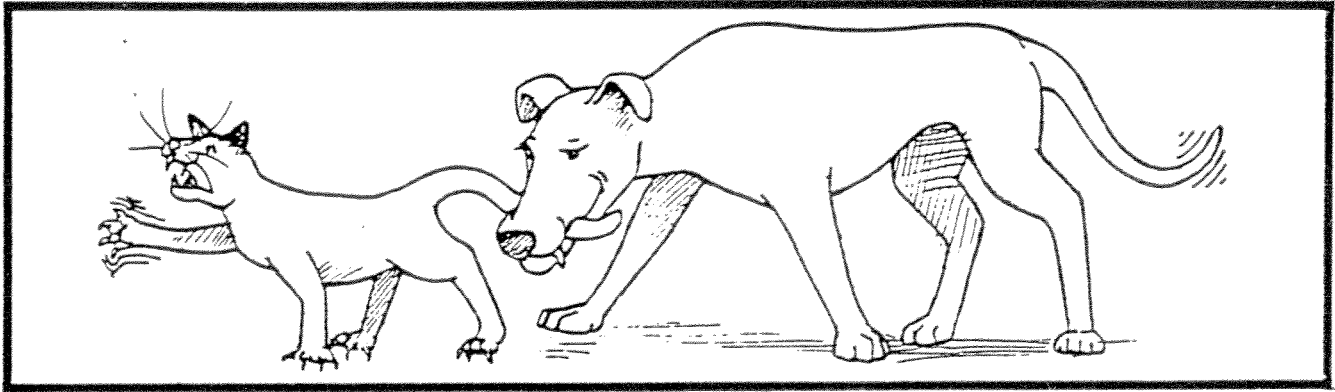

2

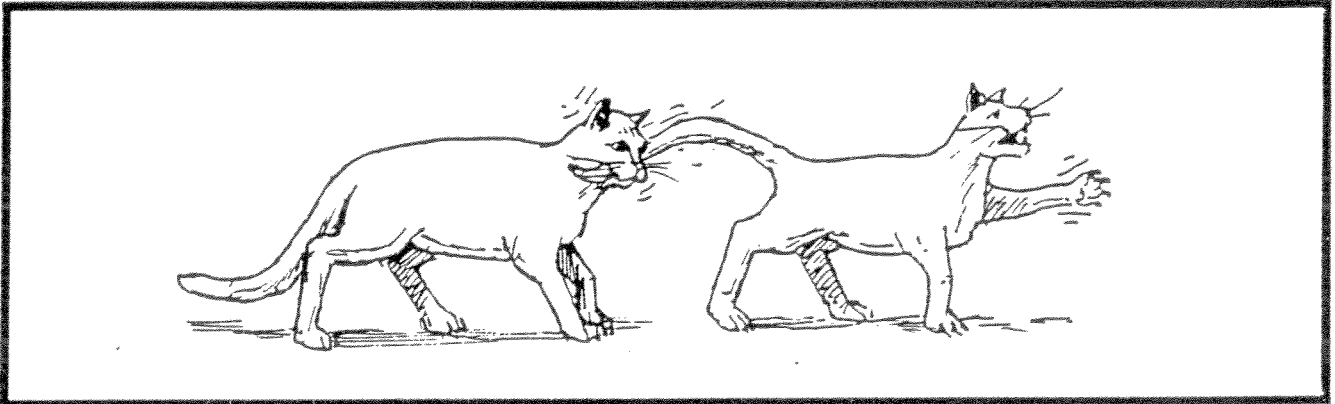

3

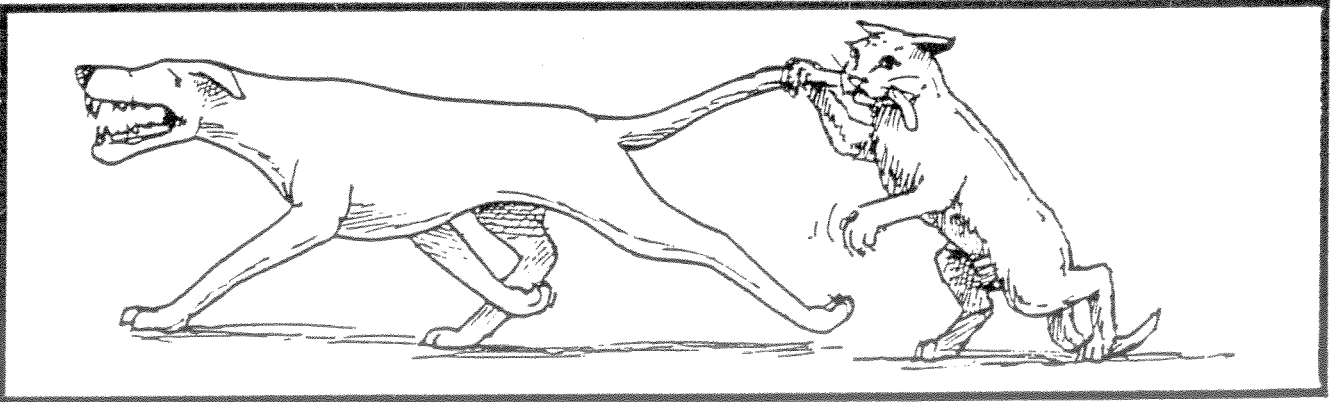

4

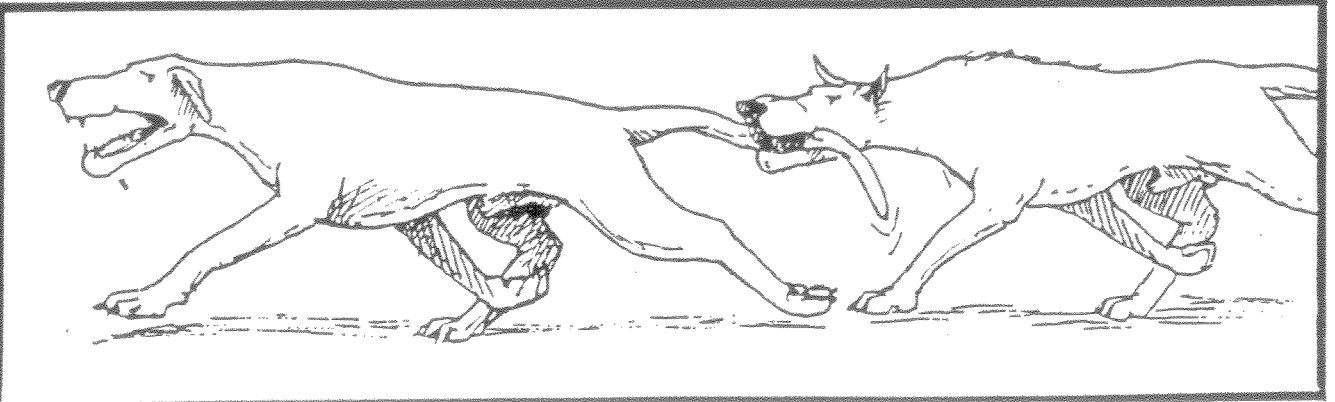

1



2



3



4

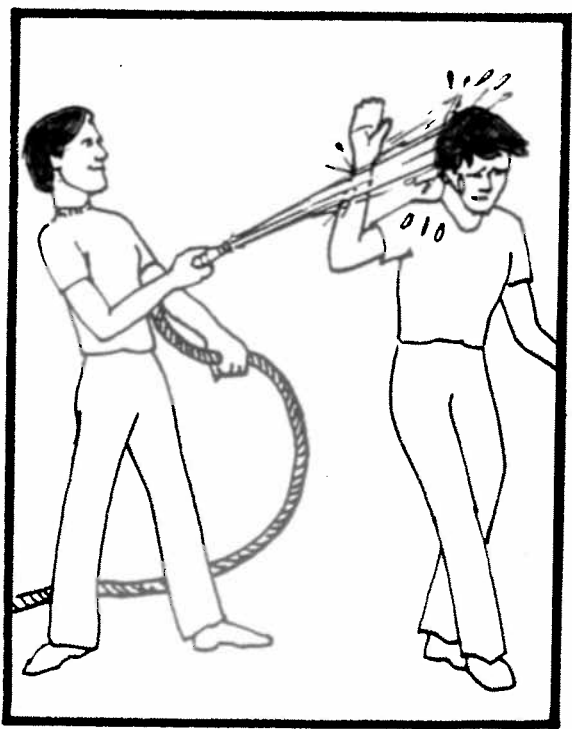

6

1

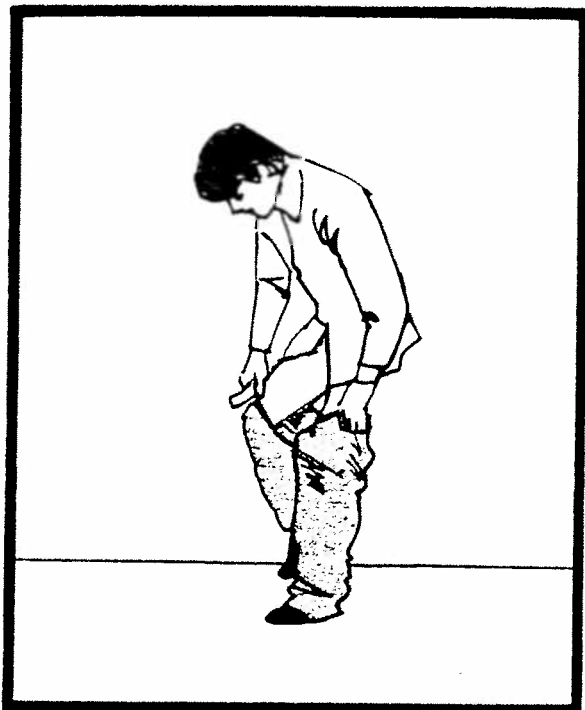

2

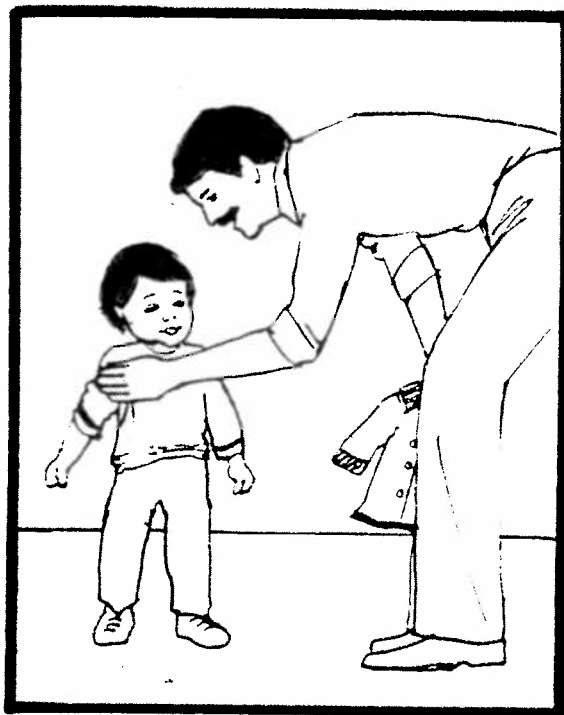

3



4

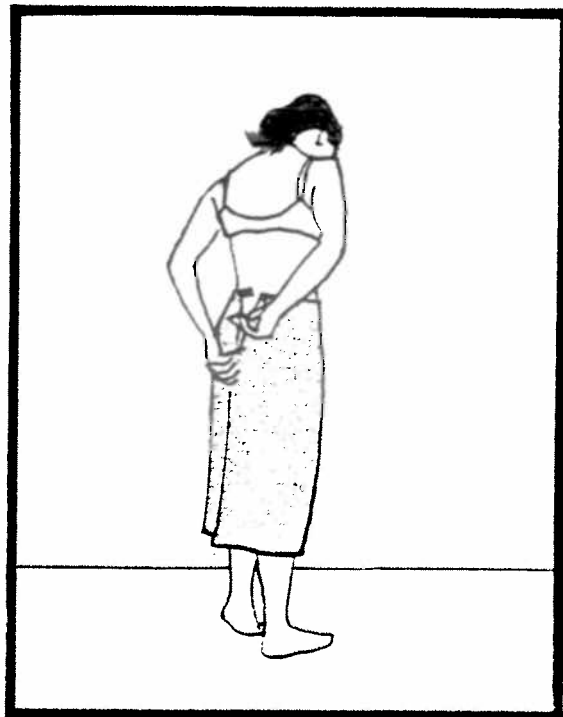

7

1

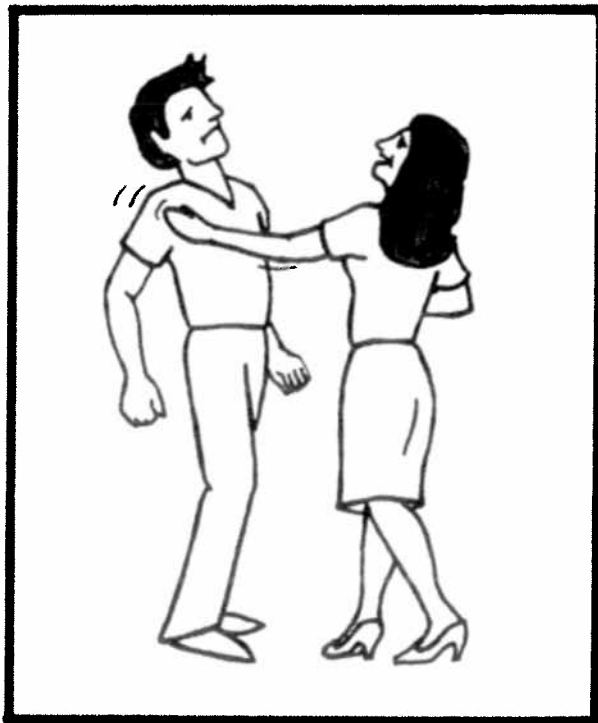

2

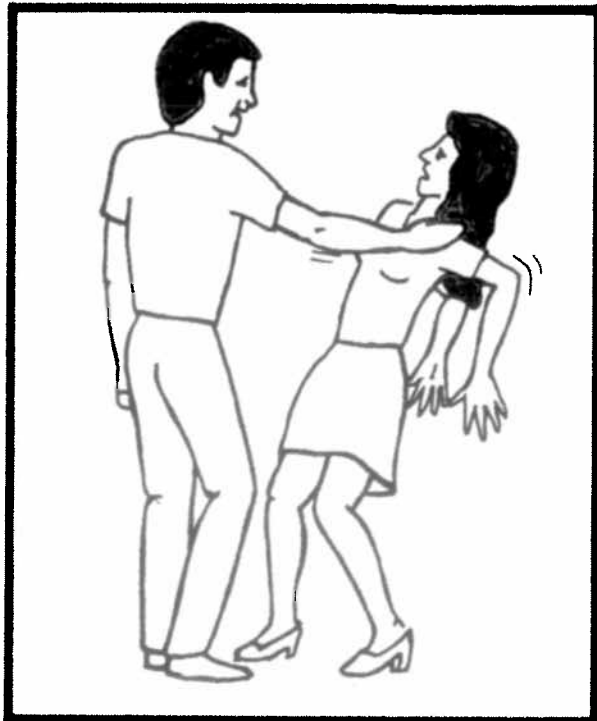

8

1

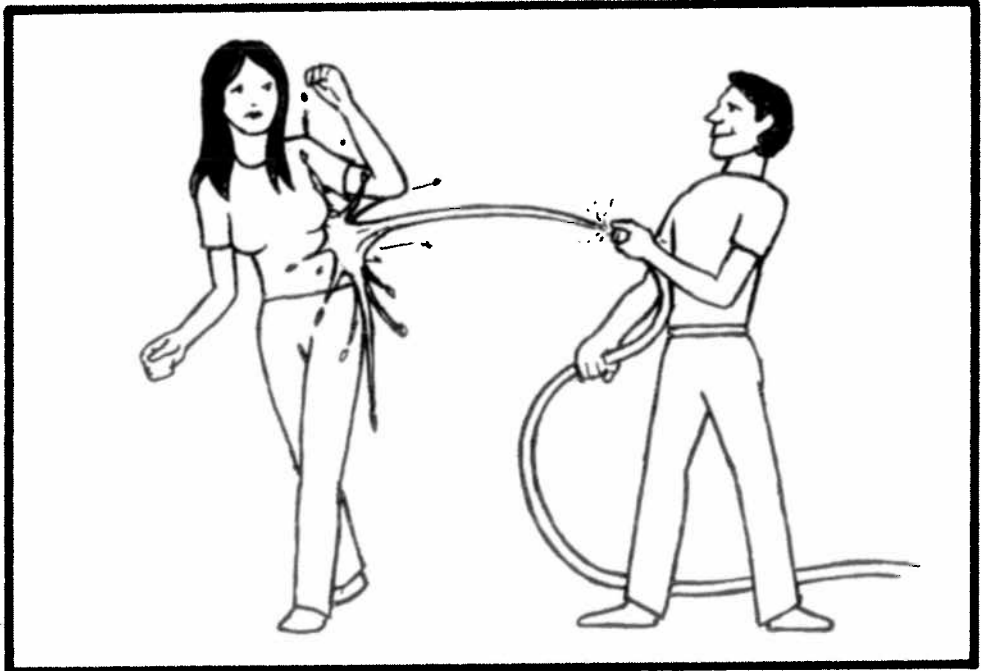

2

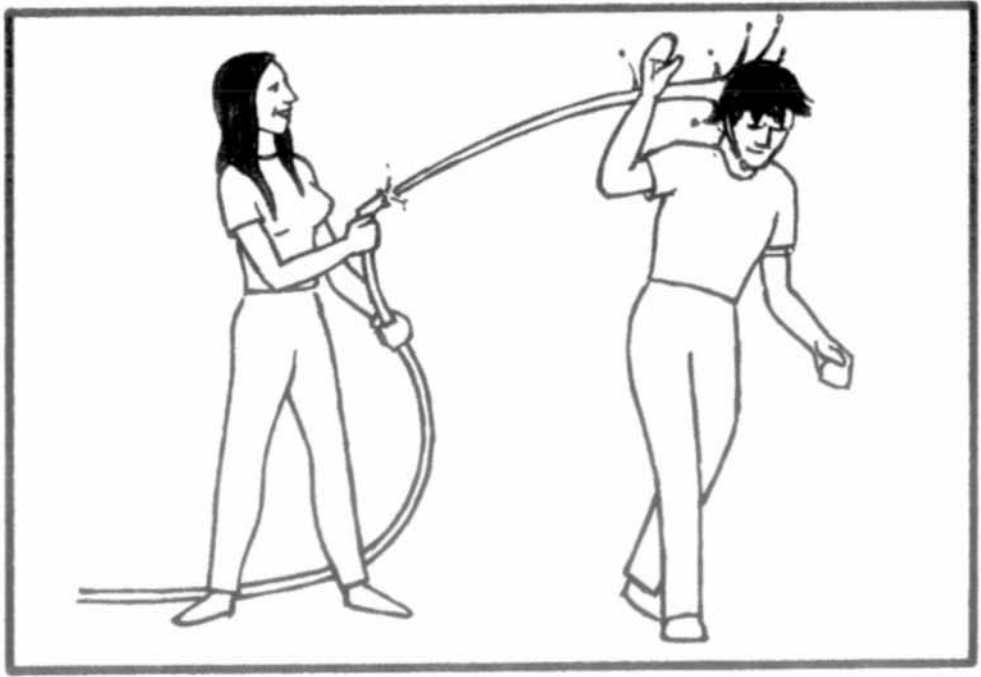

9

1

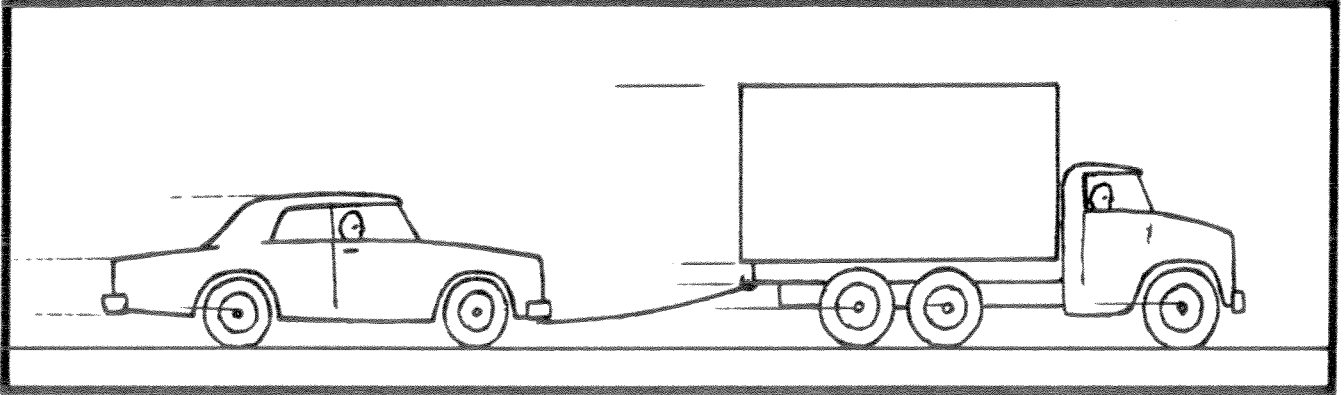

2

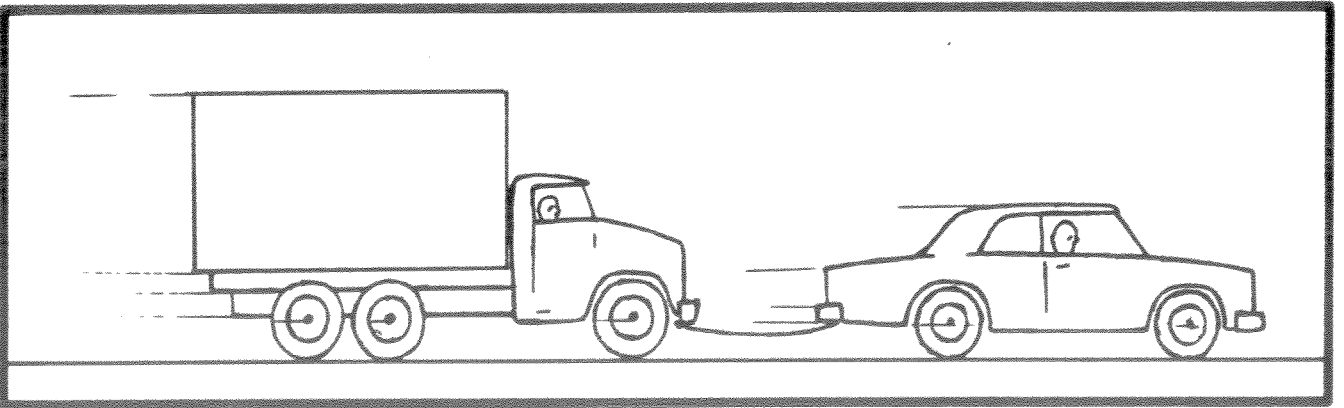

10

1



2

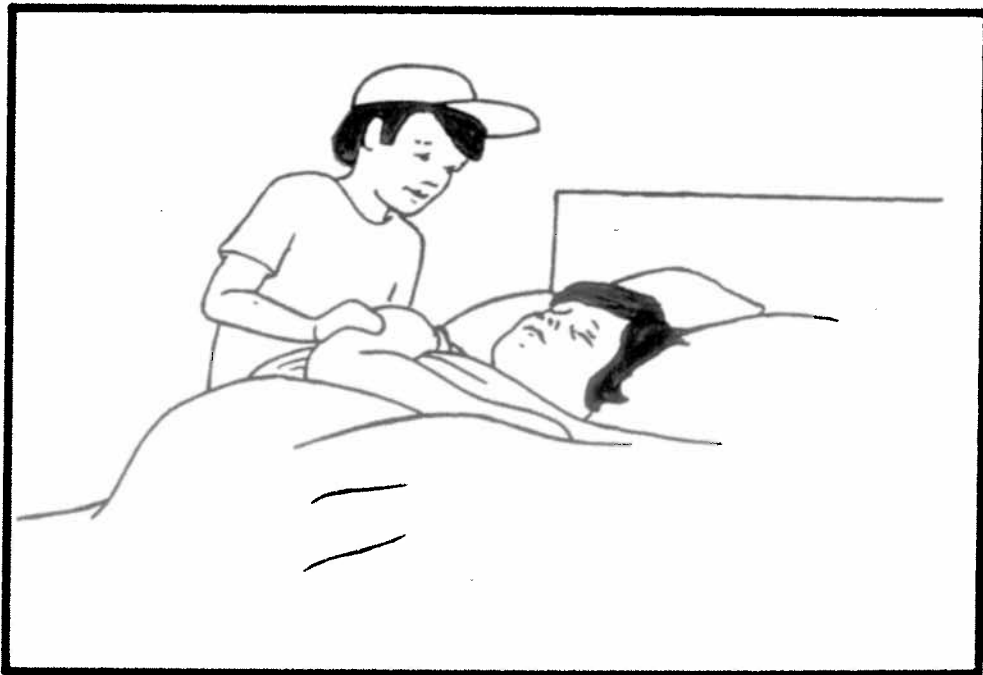

11

1

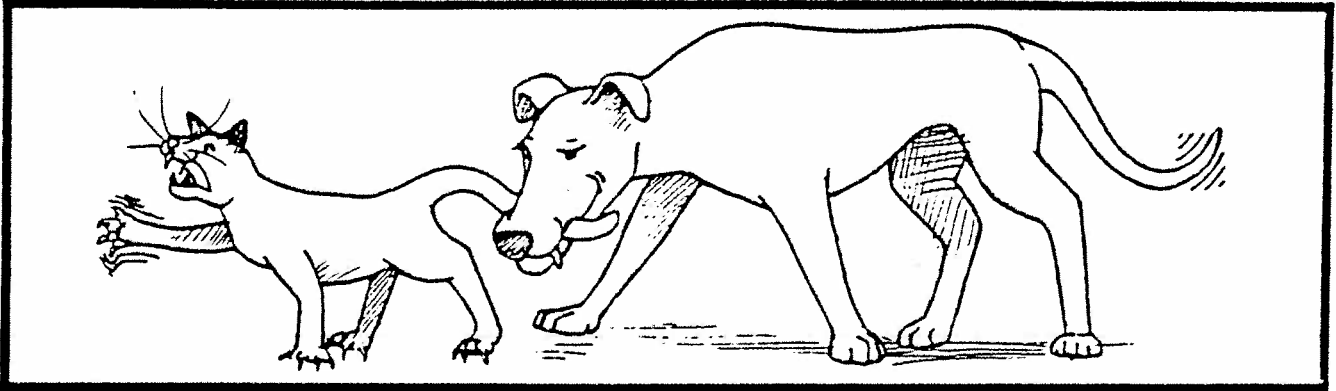

2

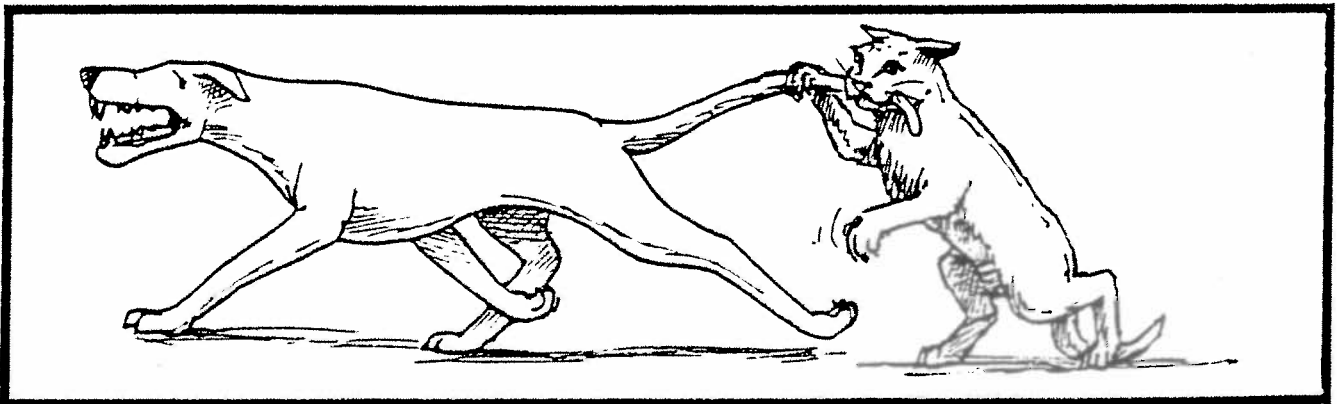

12



1

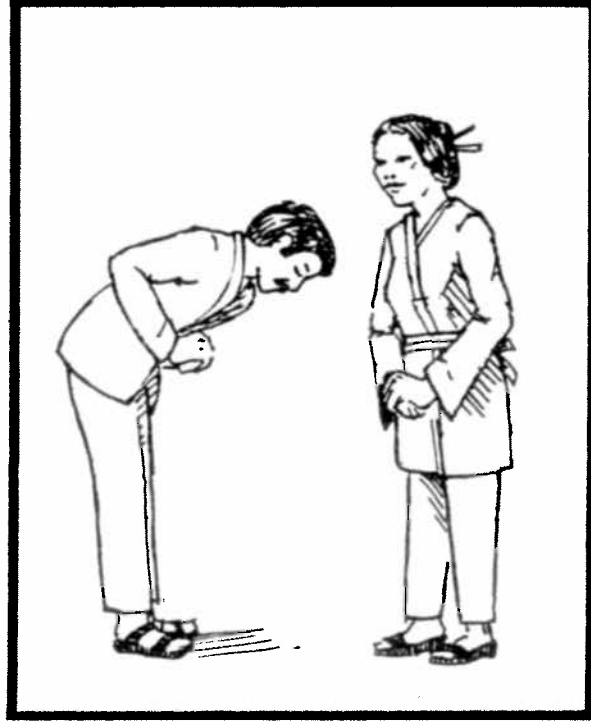

2

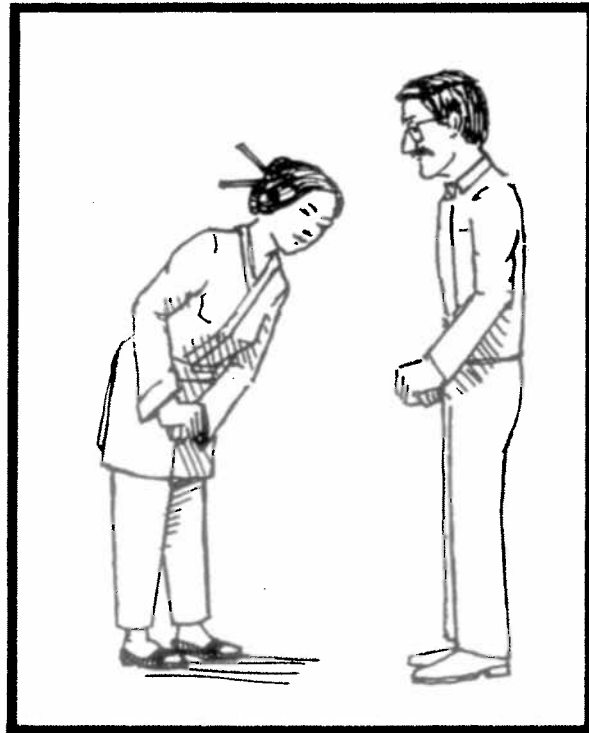







1

2



1

2

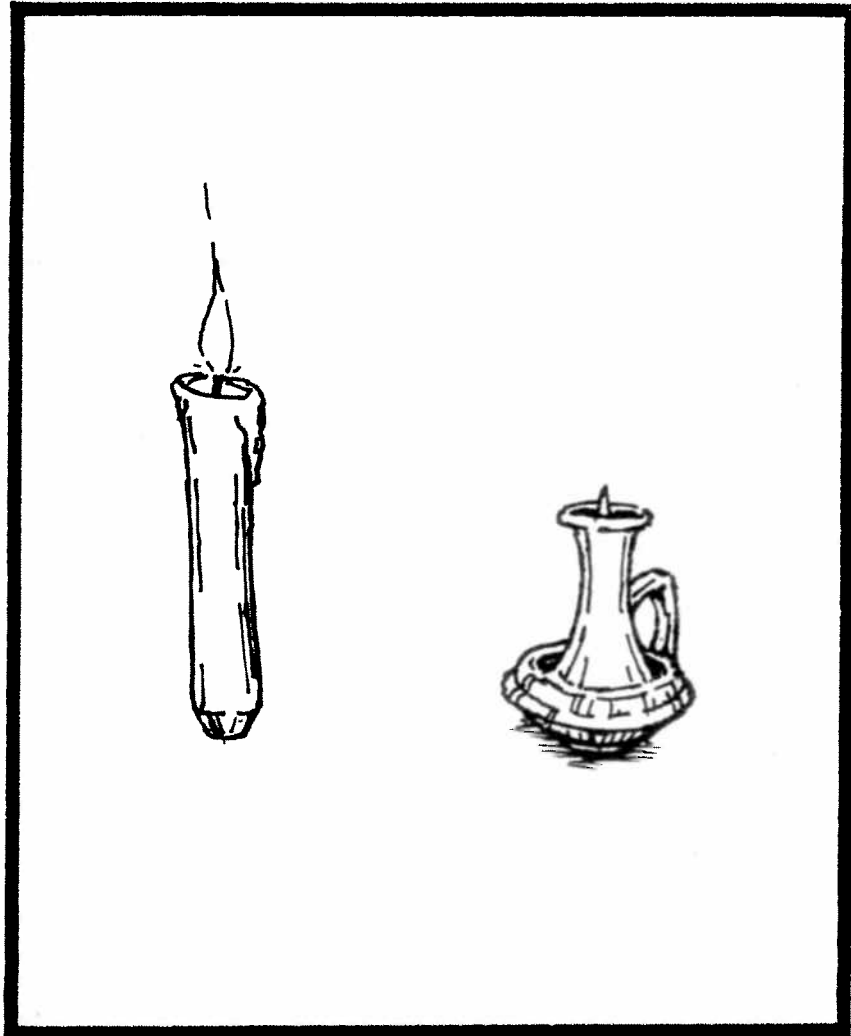

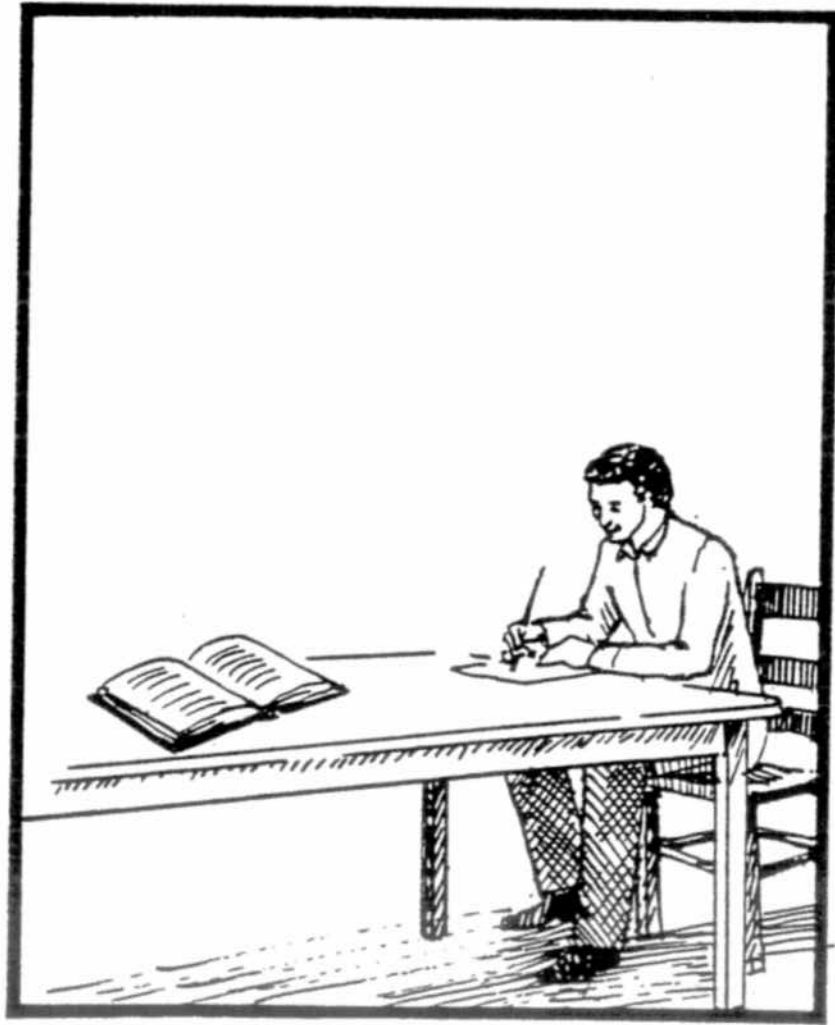

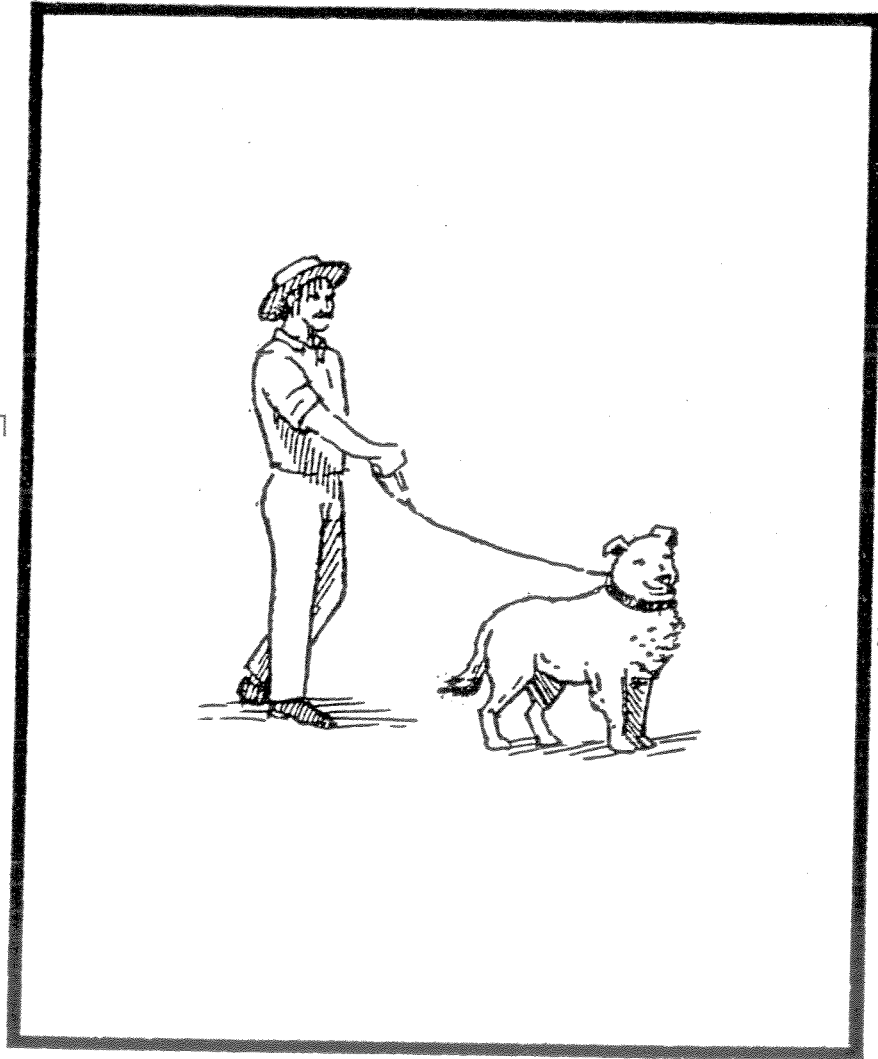



1

2

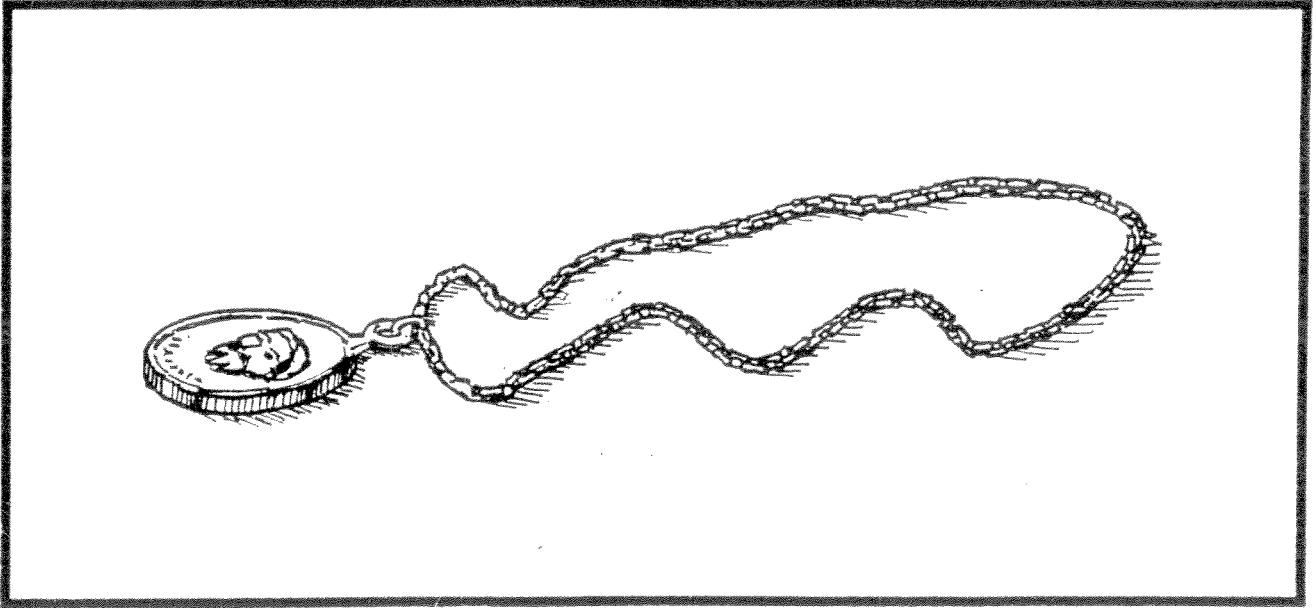



1

2



1

2



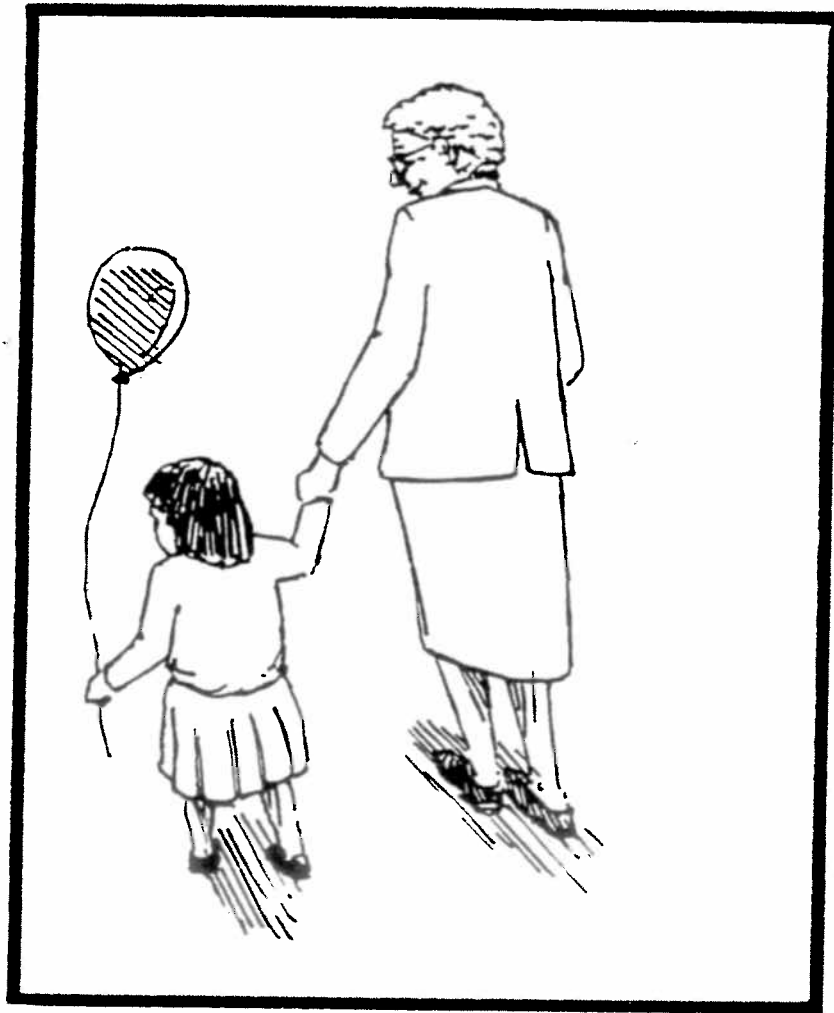

2

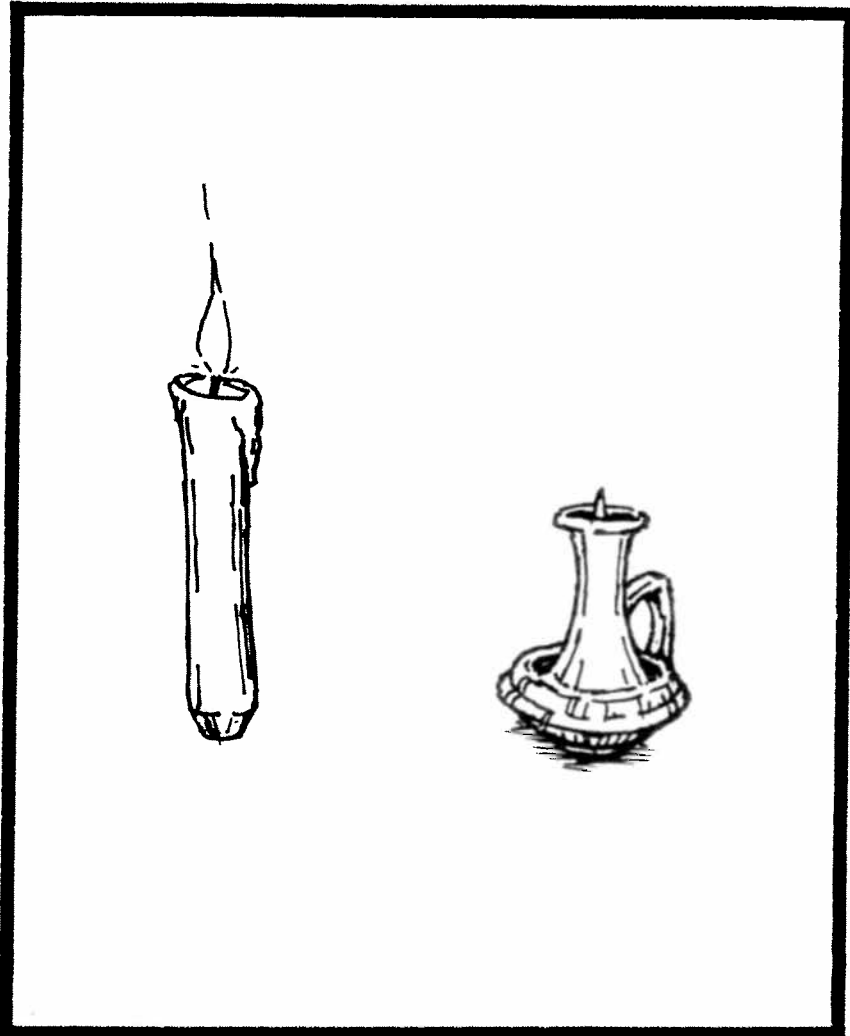

1

2

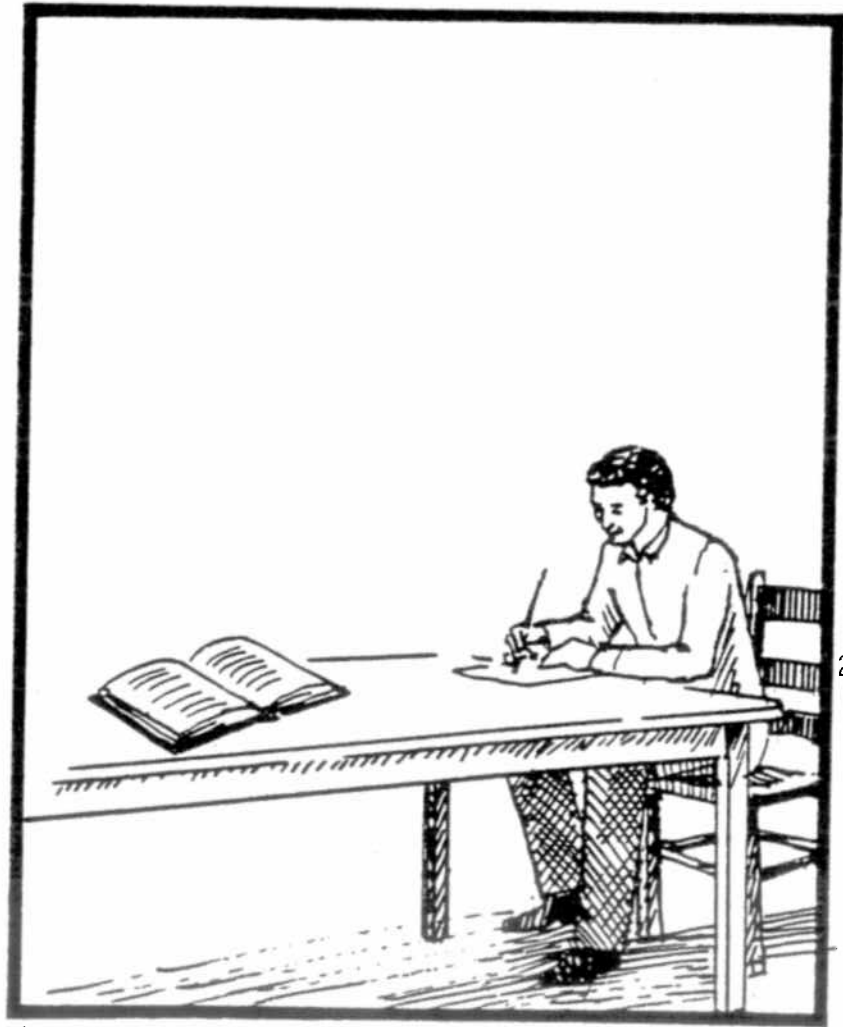

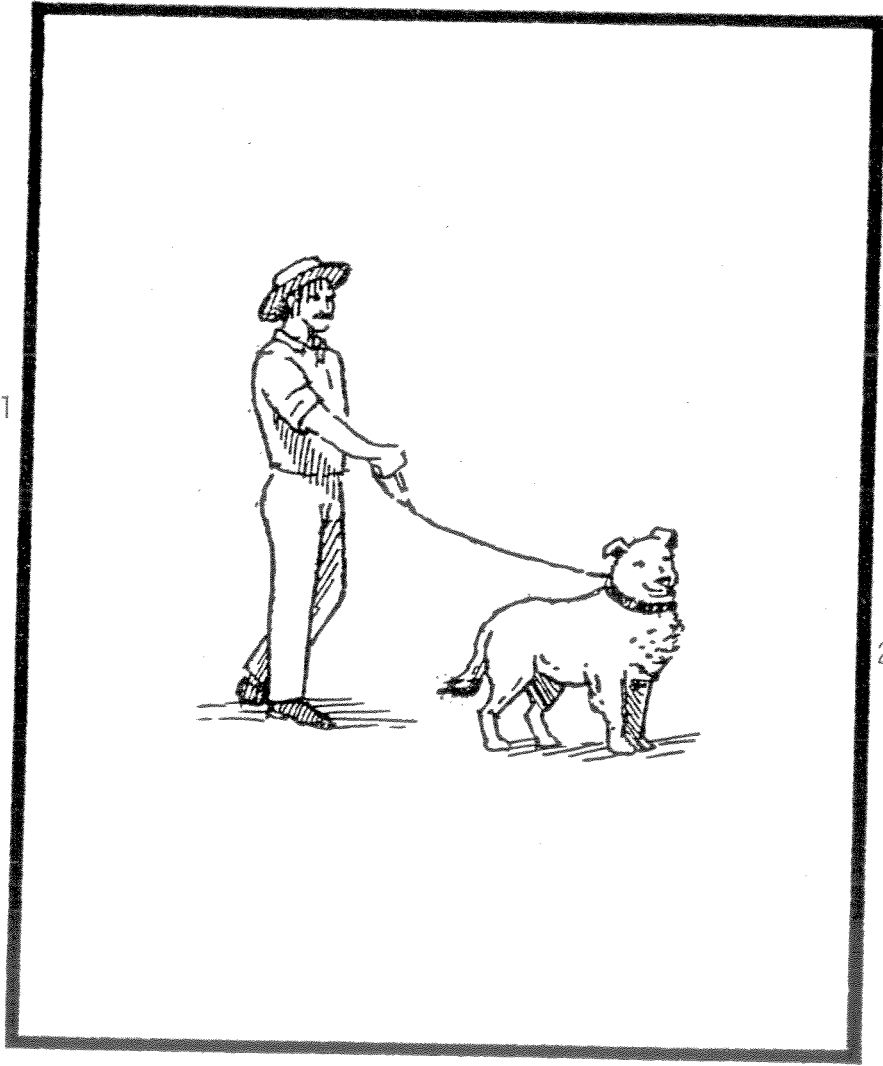

2



1

2

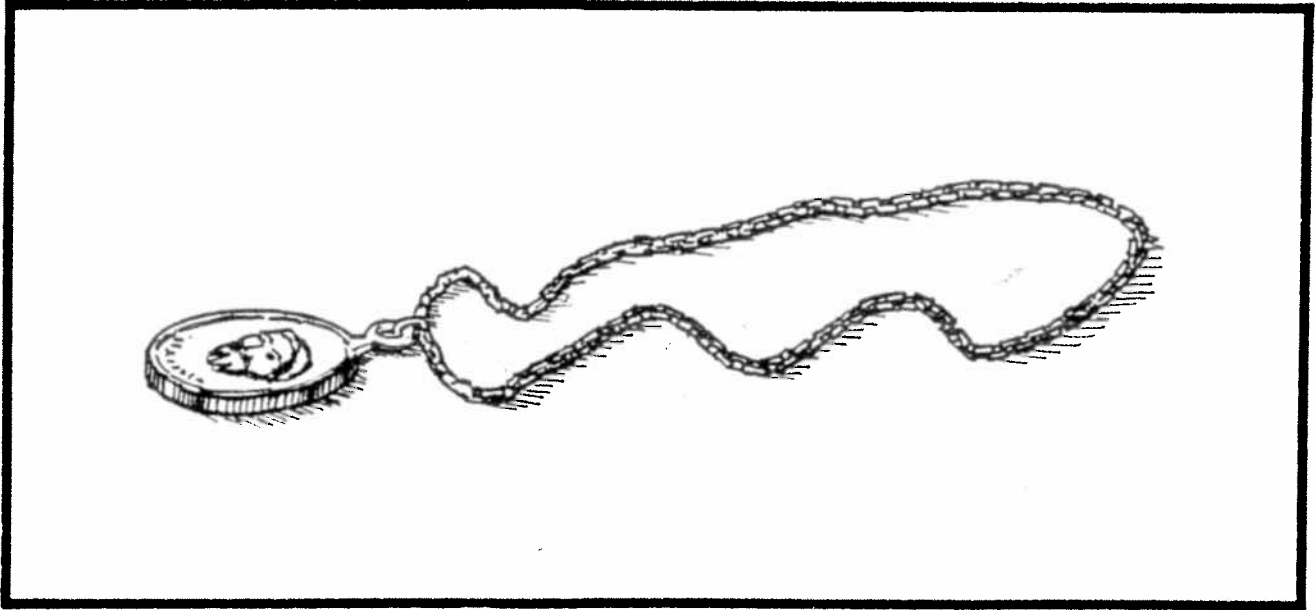

DIỄN TẢ

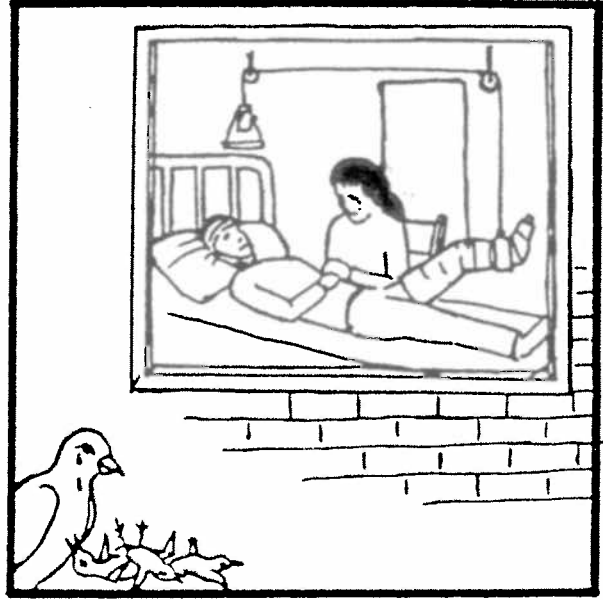
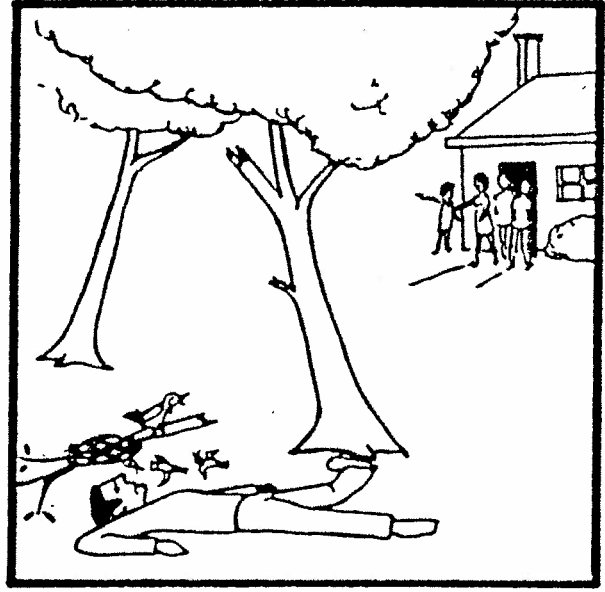
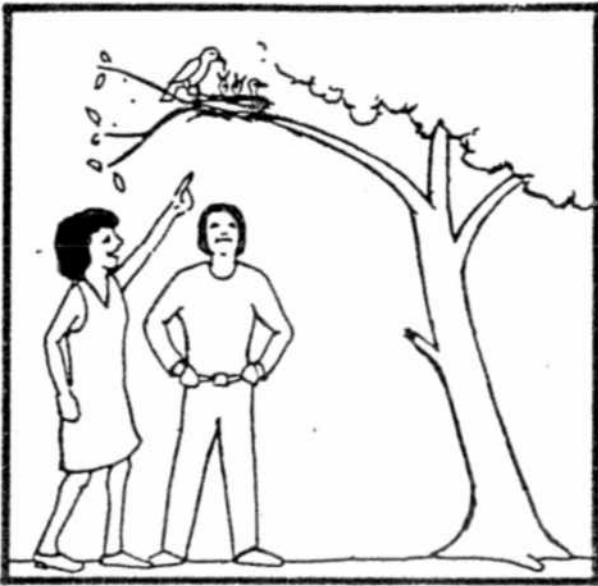

Chuối

Giỏ

Len

Cửa

Tim

Thuốc

Báo

Cây

Lồng

Bánh

Người con trai chào người con gái.

Người con gái xô nó.

Con mèo bị con chó cắn.

Chính chiếc xe tải nó kéo chiếc xe hơi.

Người con trai không xô người con gái.

Chiếc xe tải không được chiếc xe hơi kéo.



Chính con mèo nó bị con chó cắn.

Anh ta chào cô ta.

Người con gái bị người con trai xô.

Người con trai không bị người con gái xị nước.

## ĐỌC THÂM

«Một người đàn ông dẫn chó đi săn. Ông ta bắt được một con heo rừng. Trở về làng, ông ta đem con heo rừng ra chợ và bán để lấy tiền mua gạo.»

## SAO CHÉP

Bay

Lúa

Chó

Sáu

Áo

HÌNH DÀNH CHO PHẦN  
KHẢ NĂNG ĐỌC VÀ HIỂU TỪNG CHỮ

Chuối

1

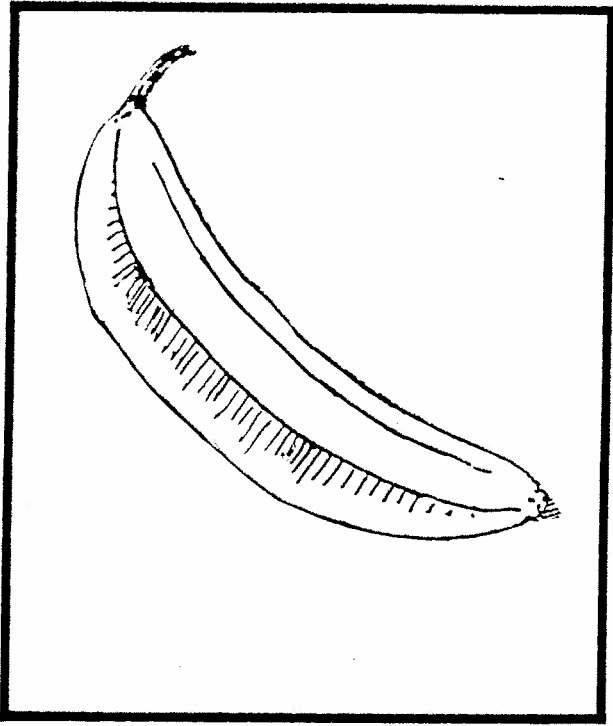

2



3

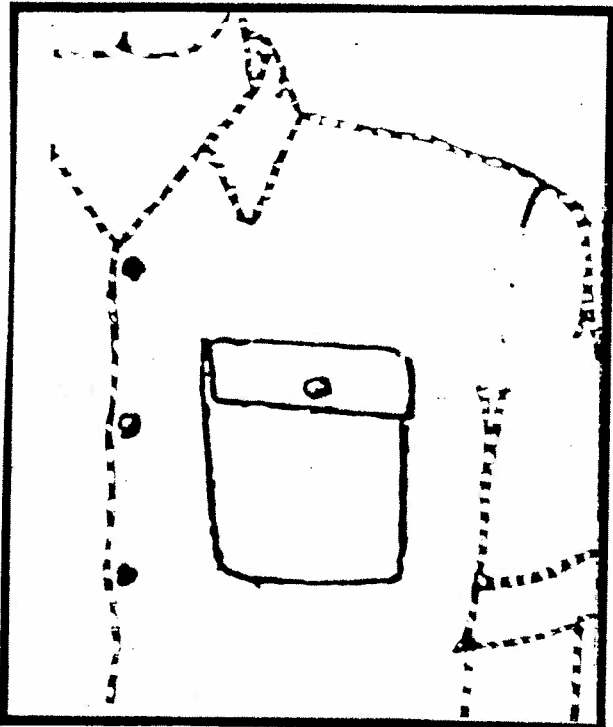

4

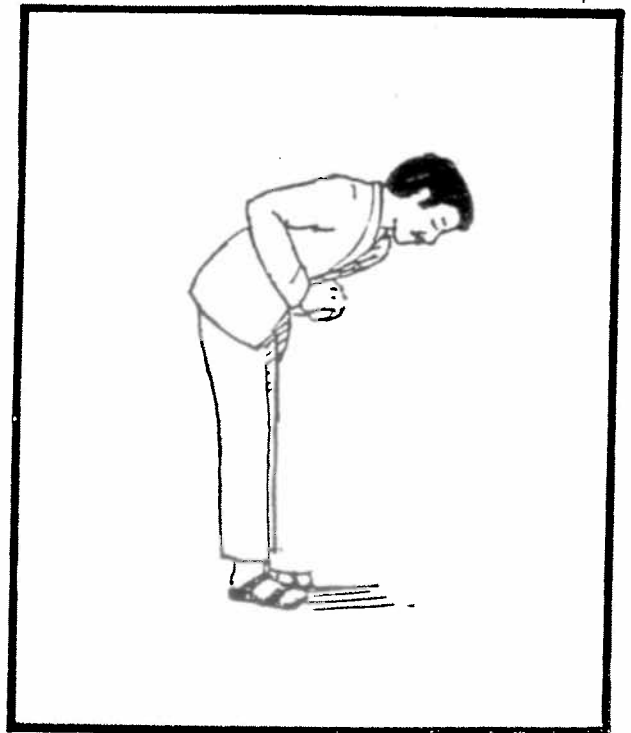

Giò



1

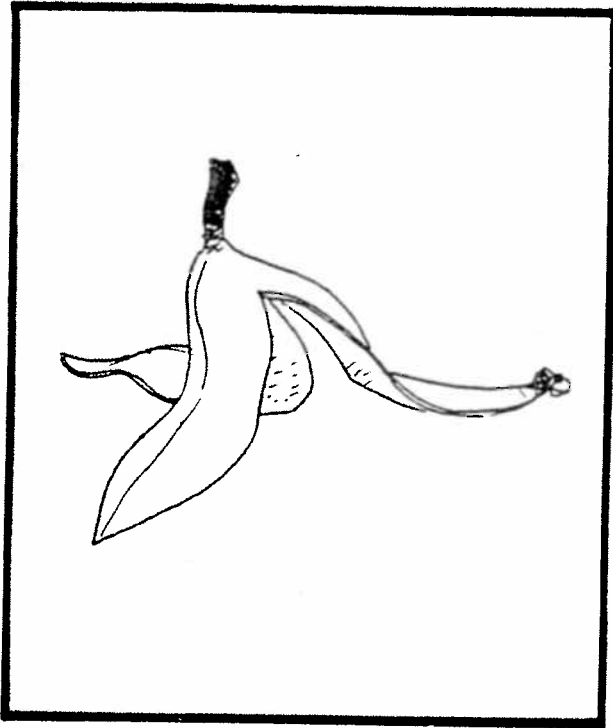

2

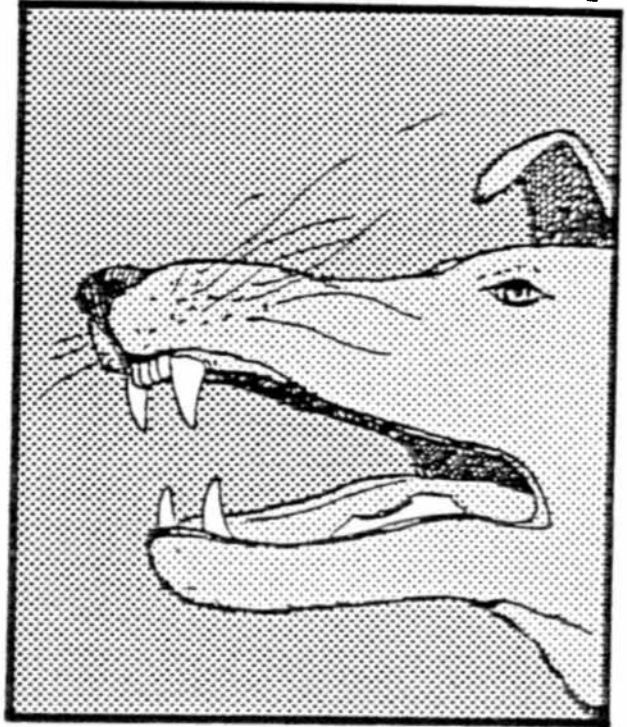

3

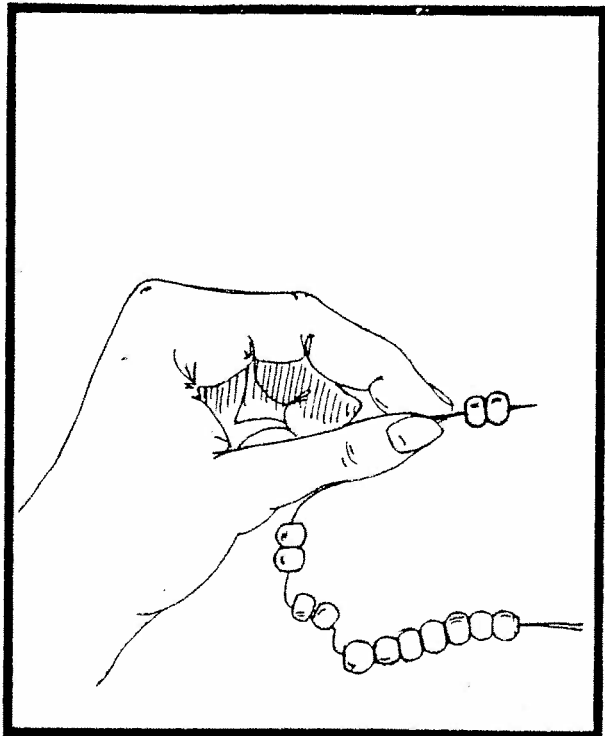

4

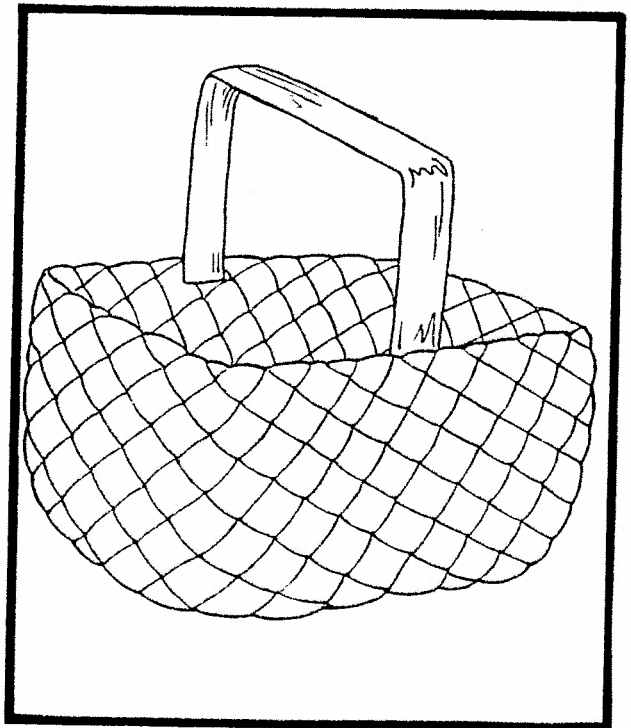

Len

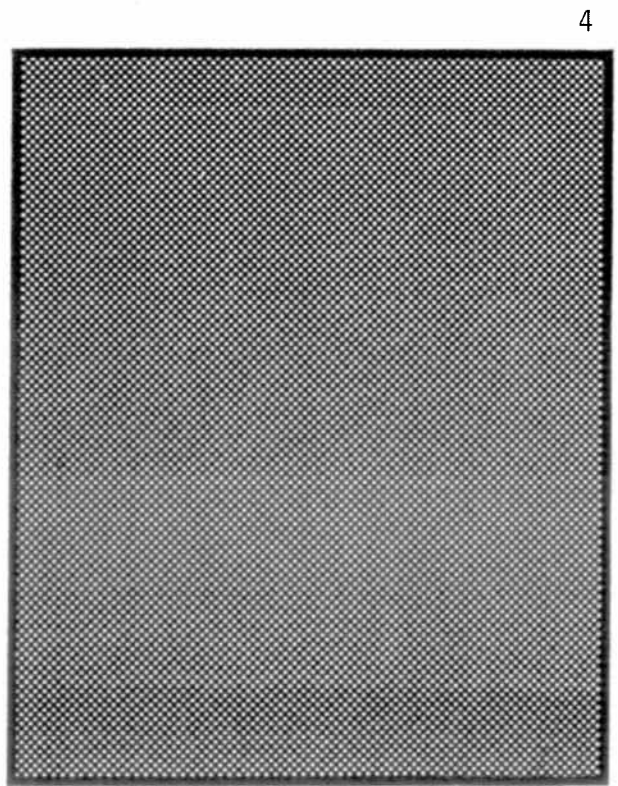
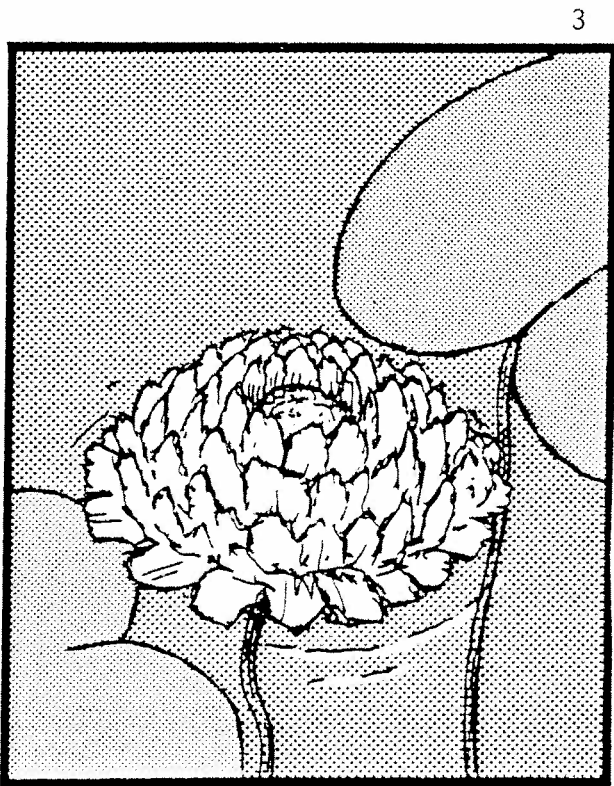
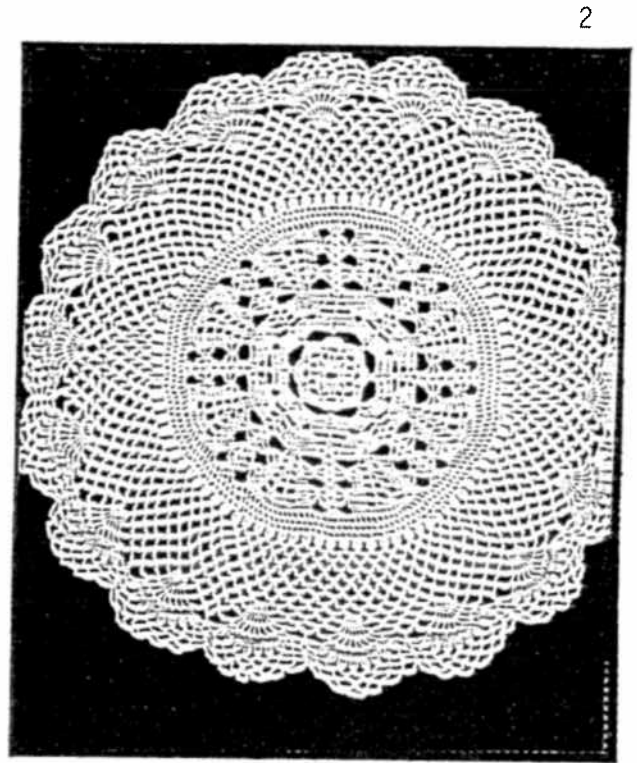
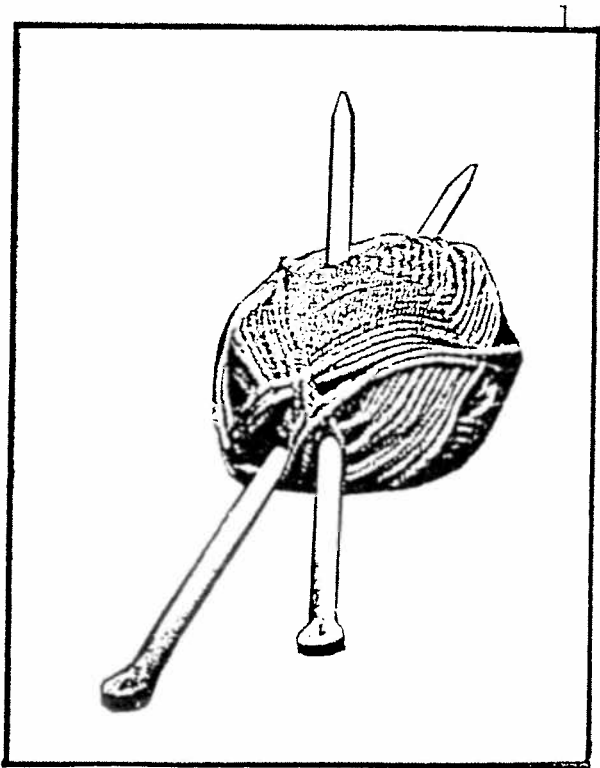

Cura

1

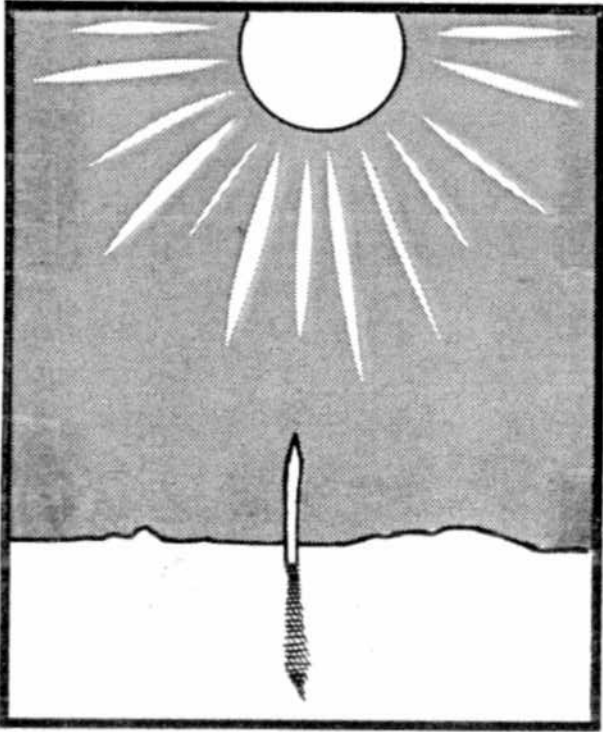

2



3

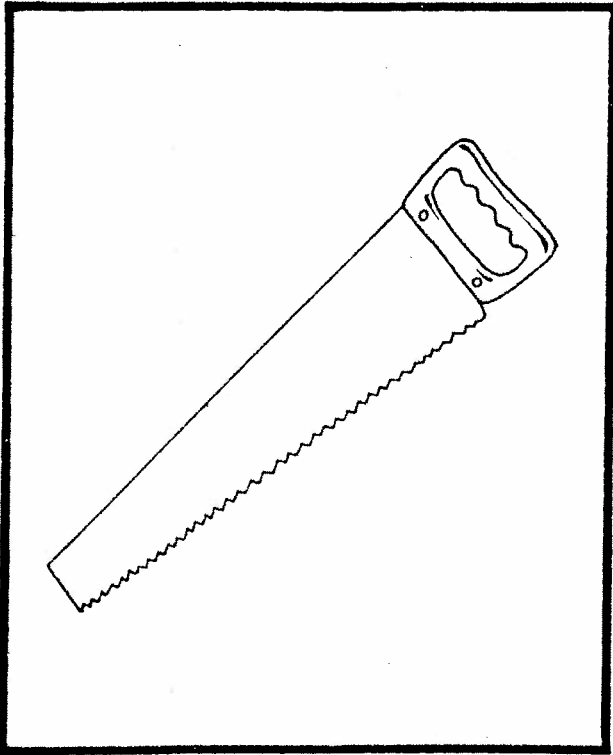

4

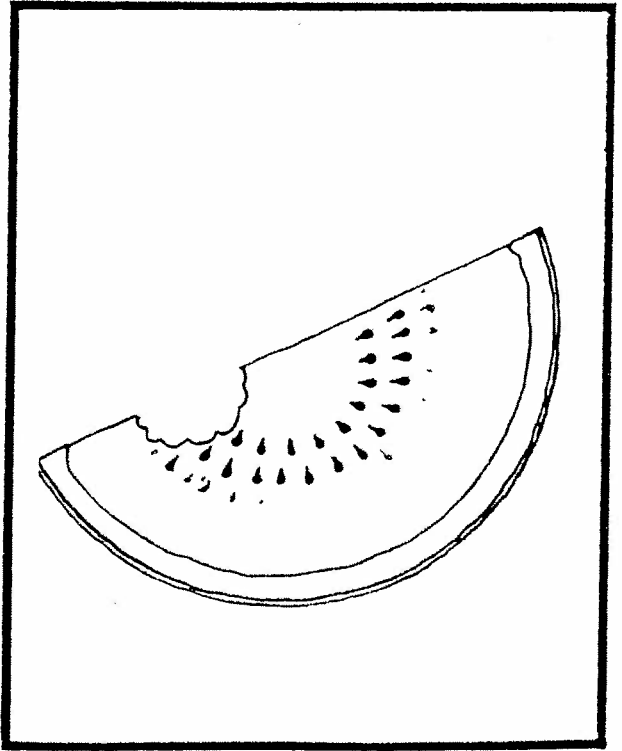

Tim

1

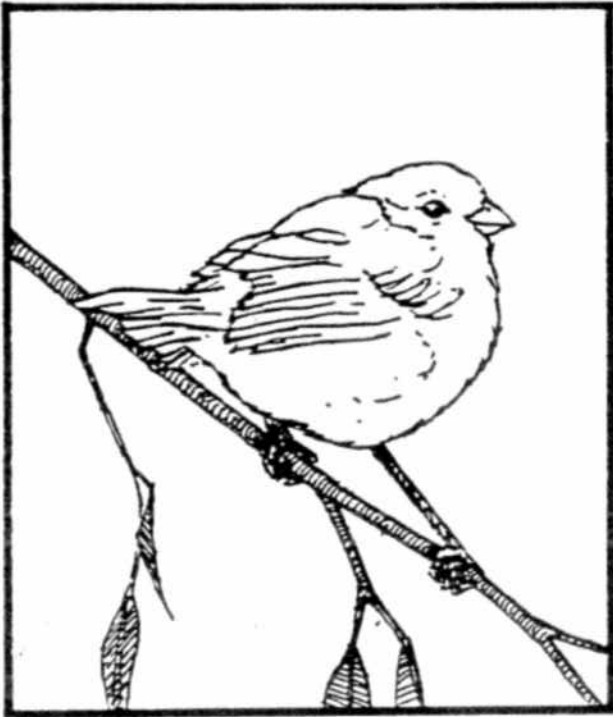

2

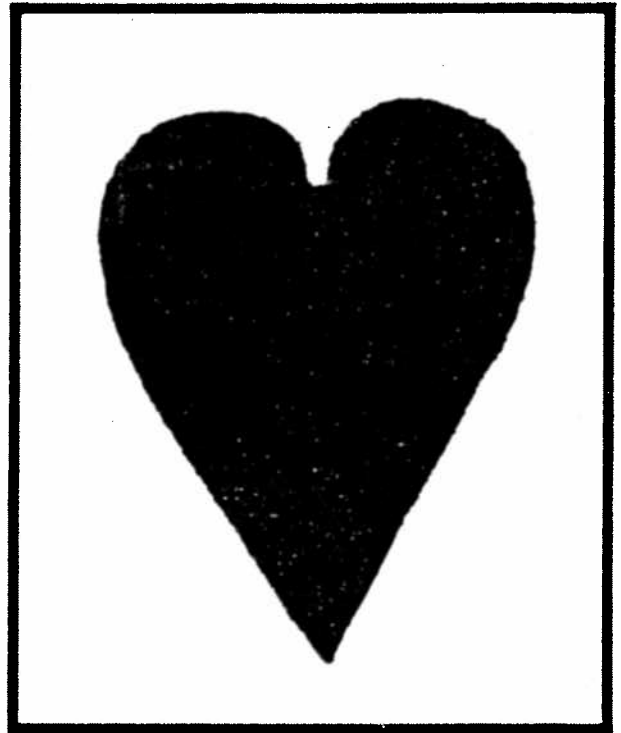

3

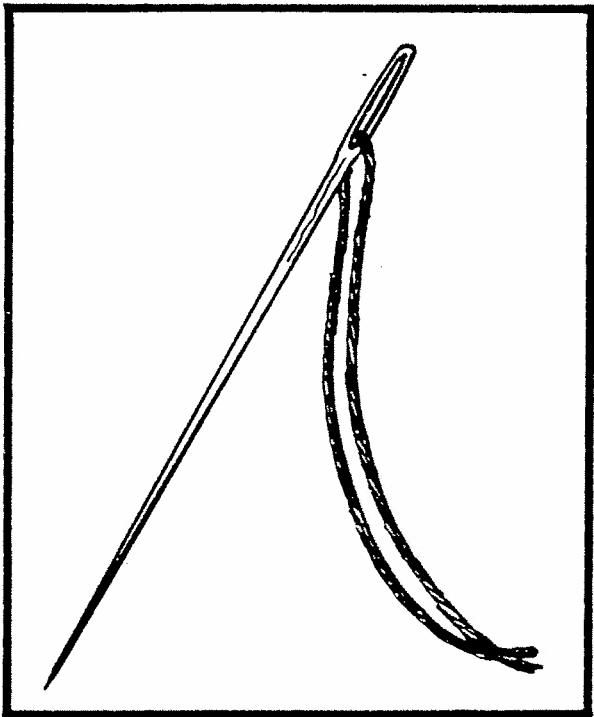

4

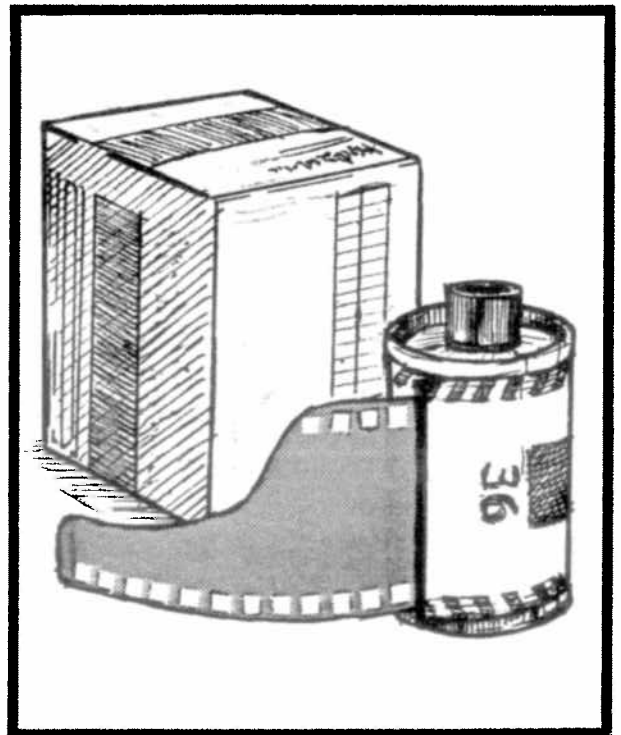

Thuốc



1

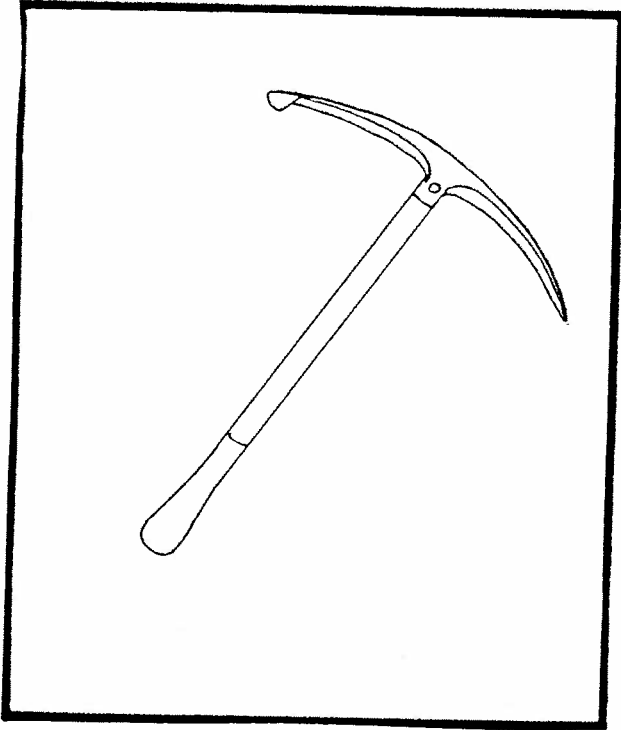

2

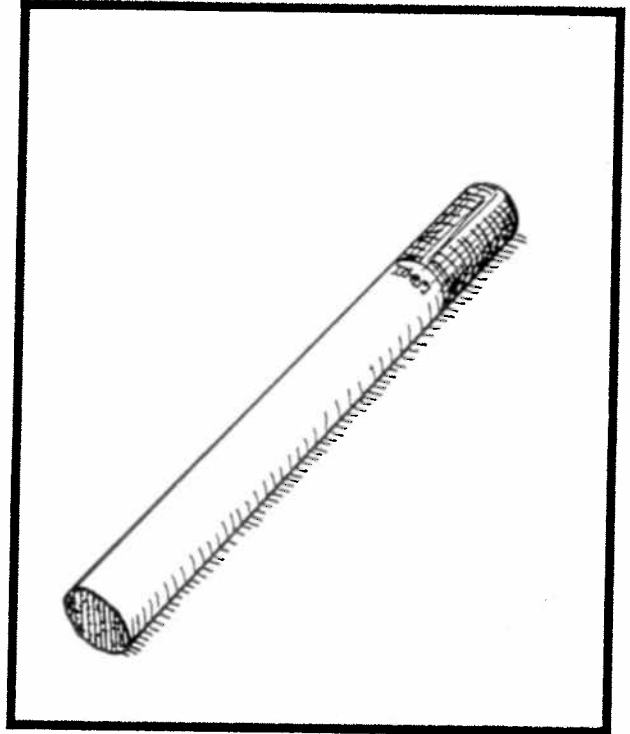

3

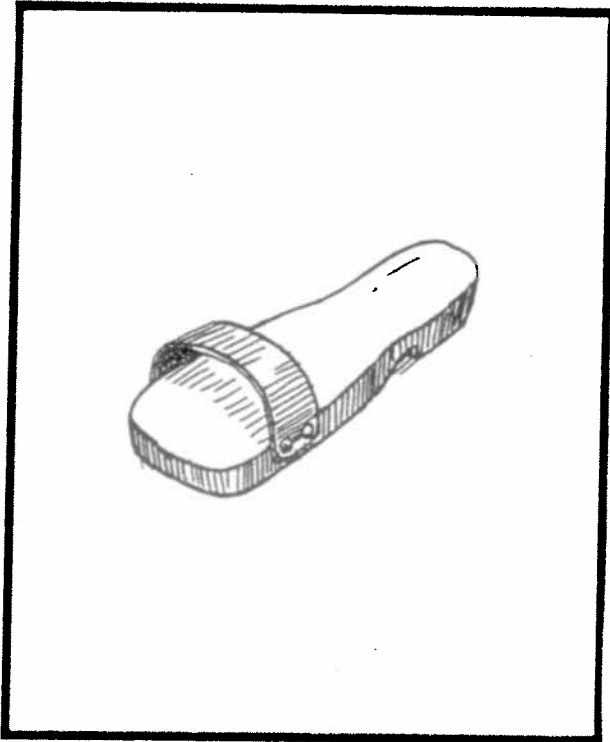

4

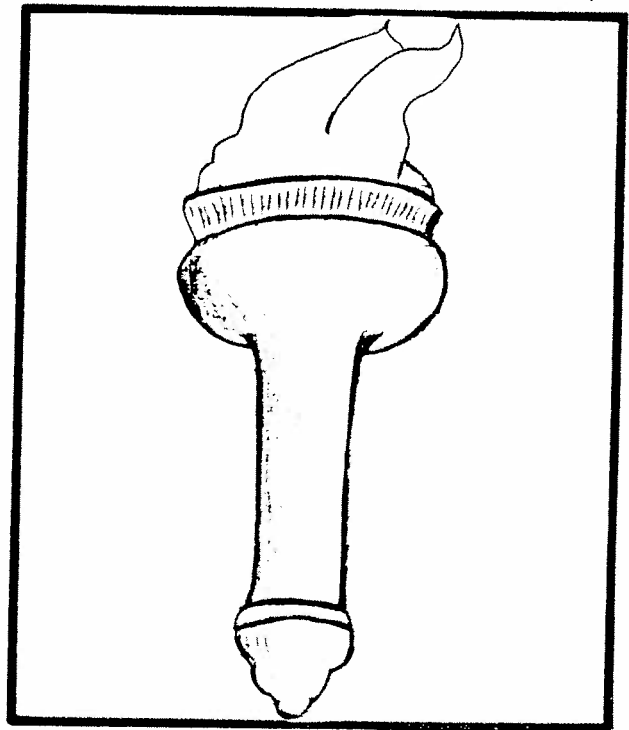

Báo

1

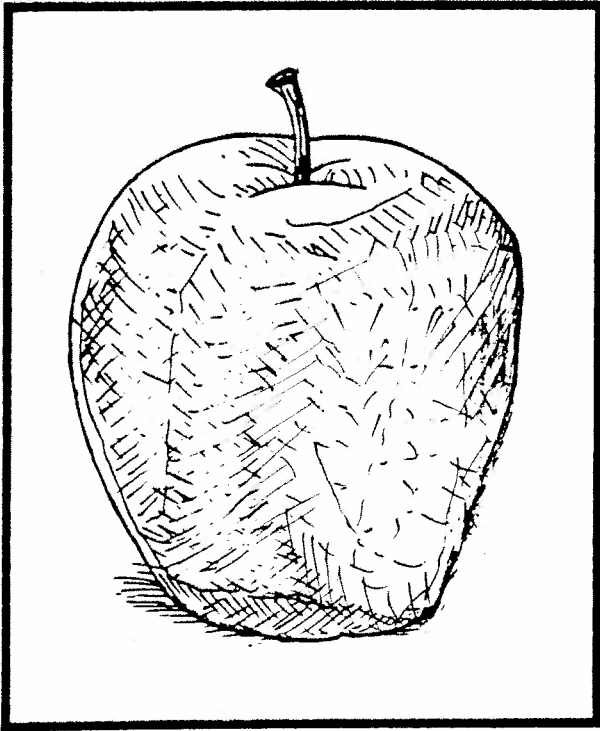

2

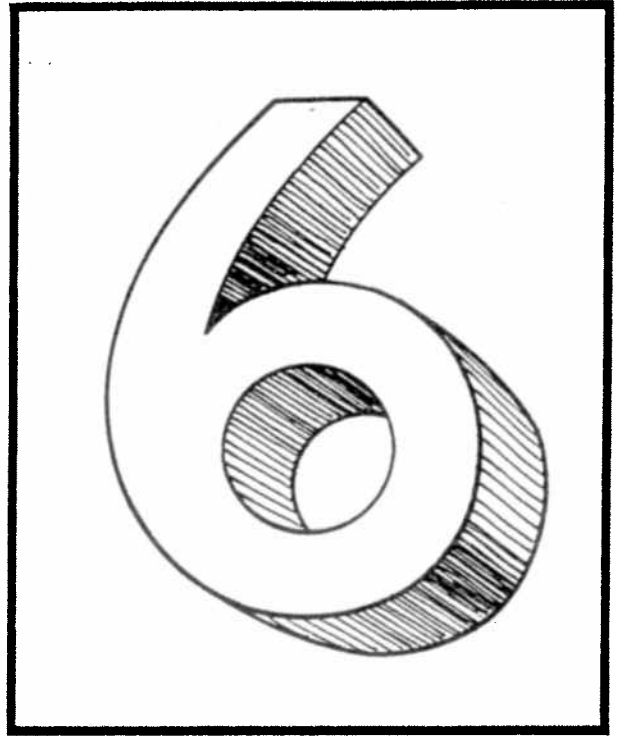

3



4

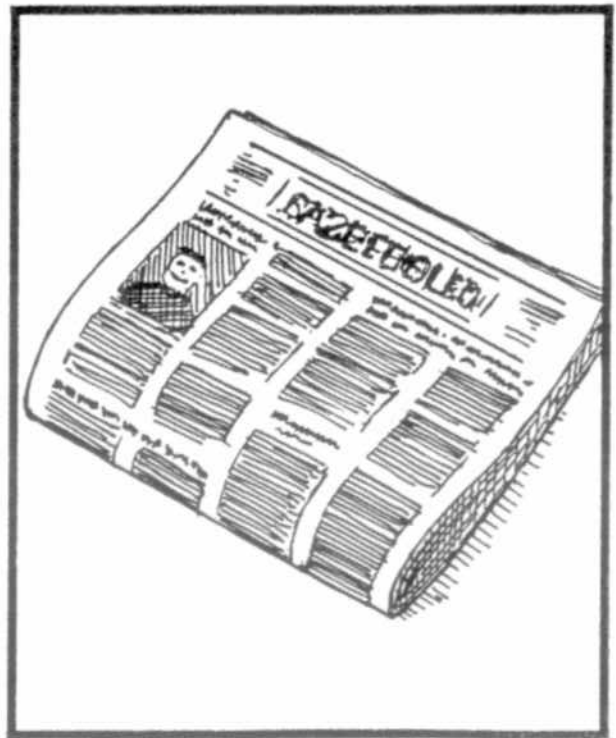

Cây

1



2

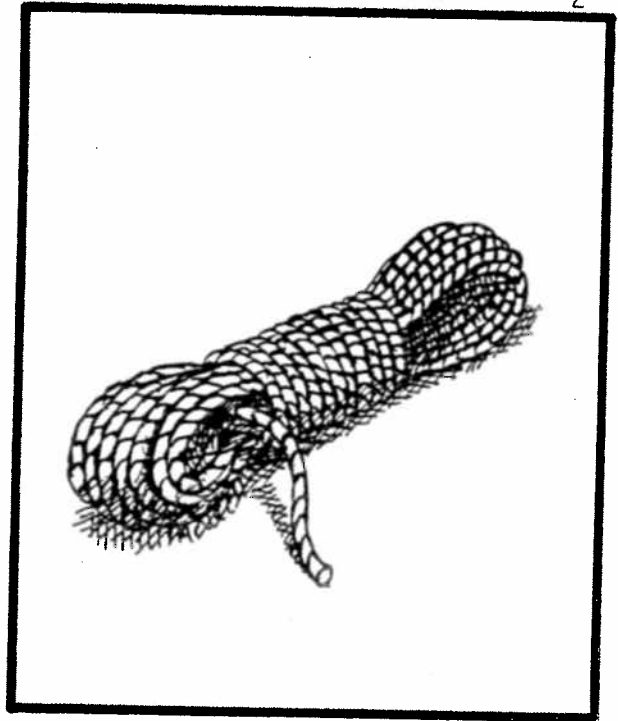

3

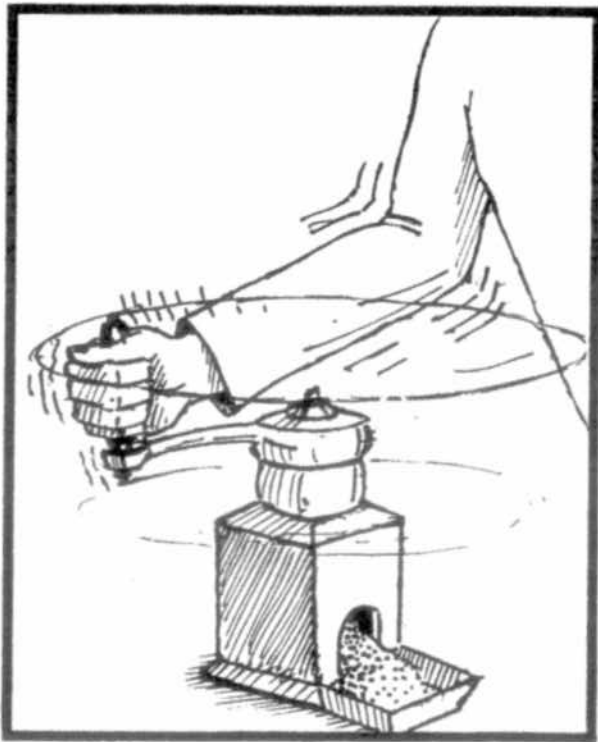

4



Lông

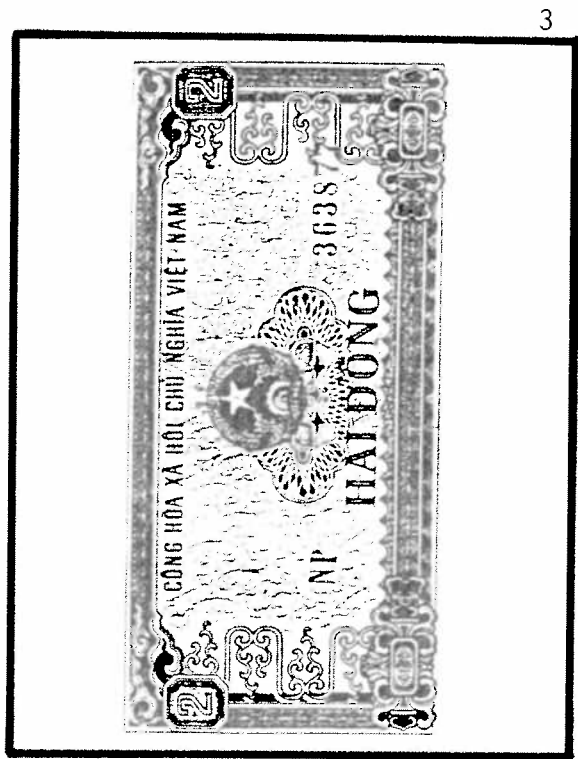
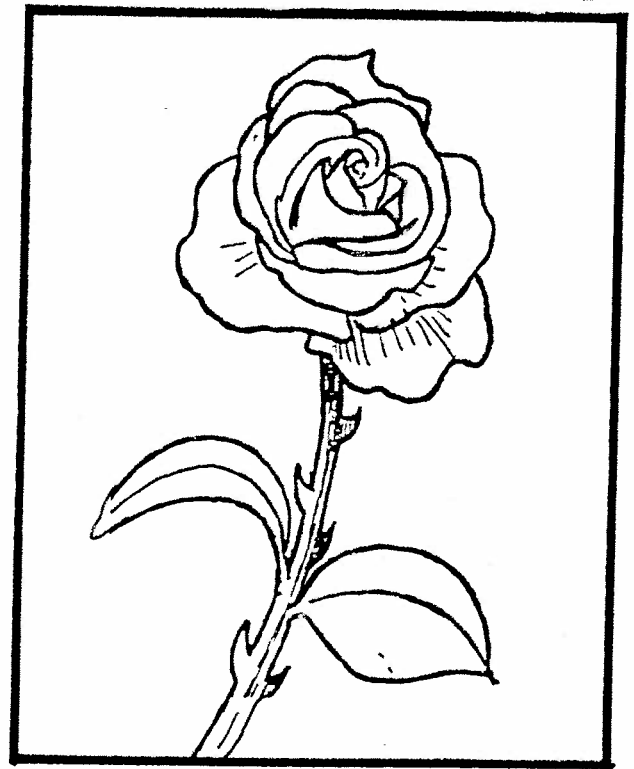
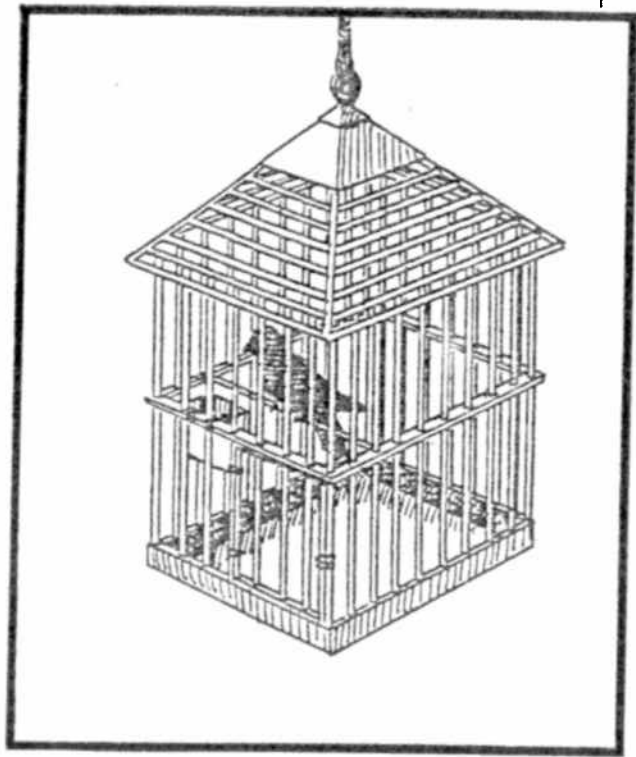

Bánh



1

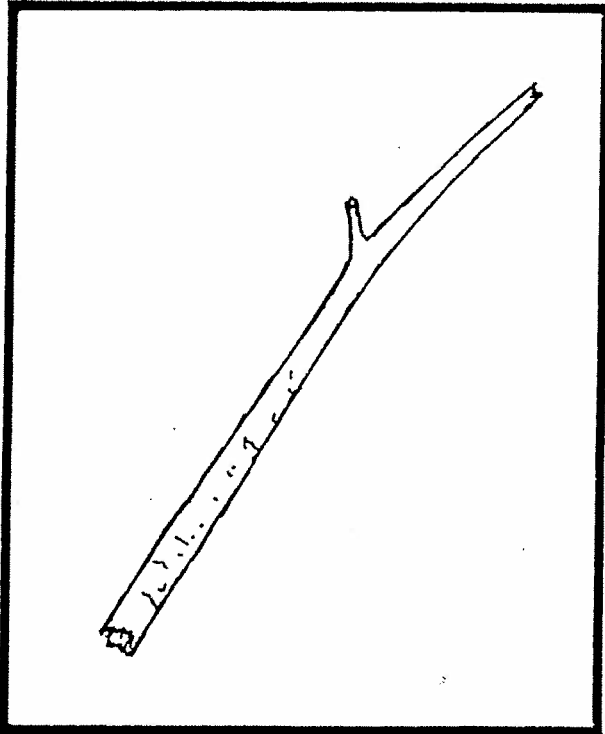

2

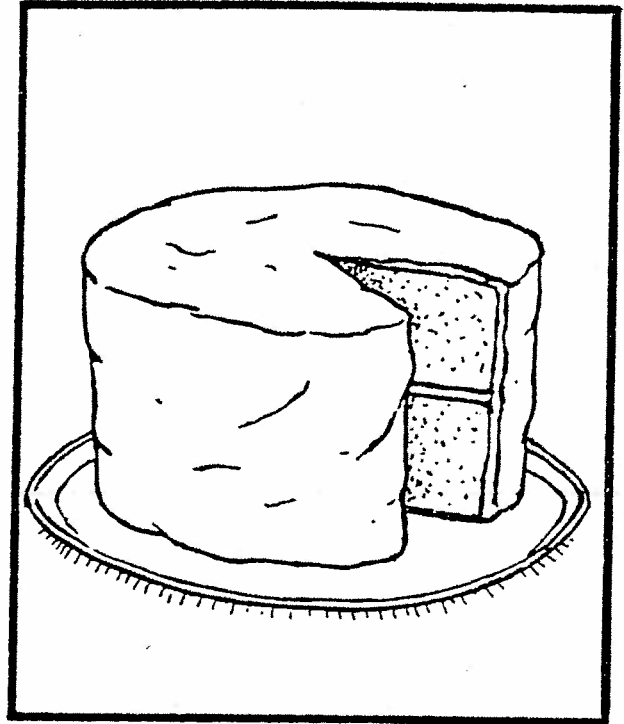

3

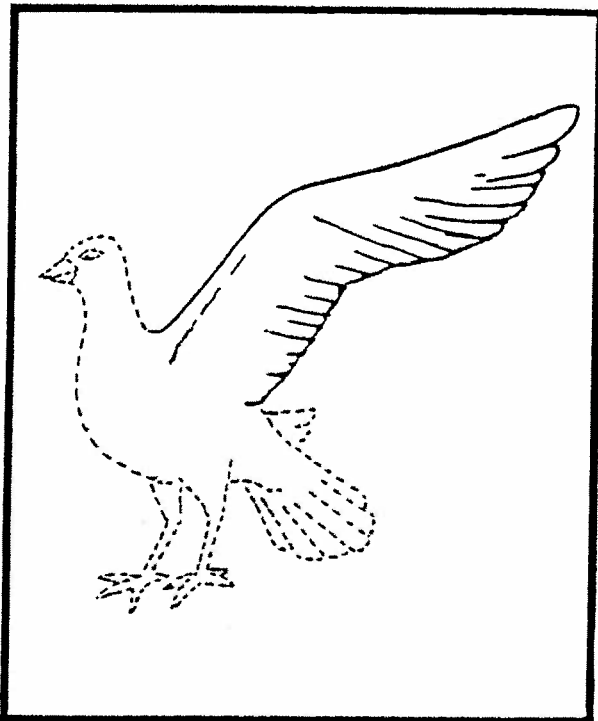

4

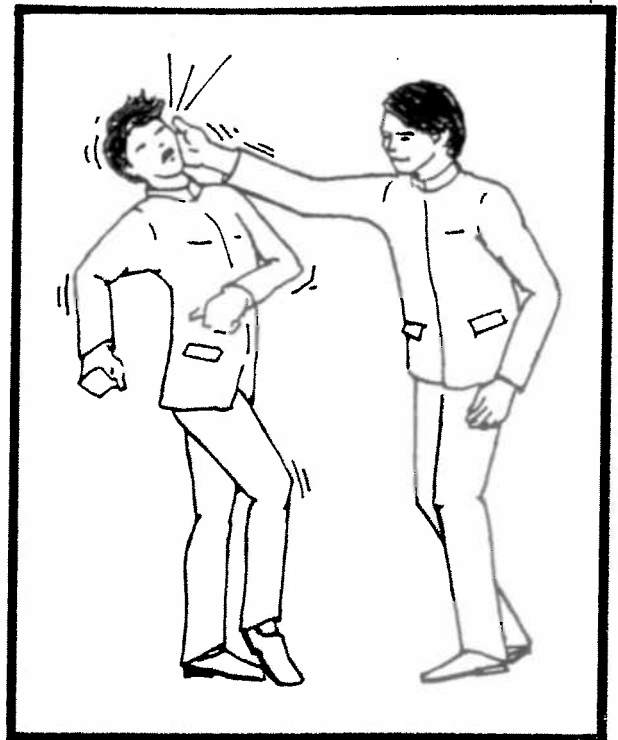



HÌNH DÀNH CHO PHẦN  
ĐỌC CÂU

Người con trai không xô người con gái.

1

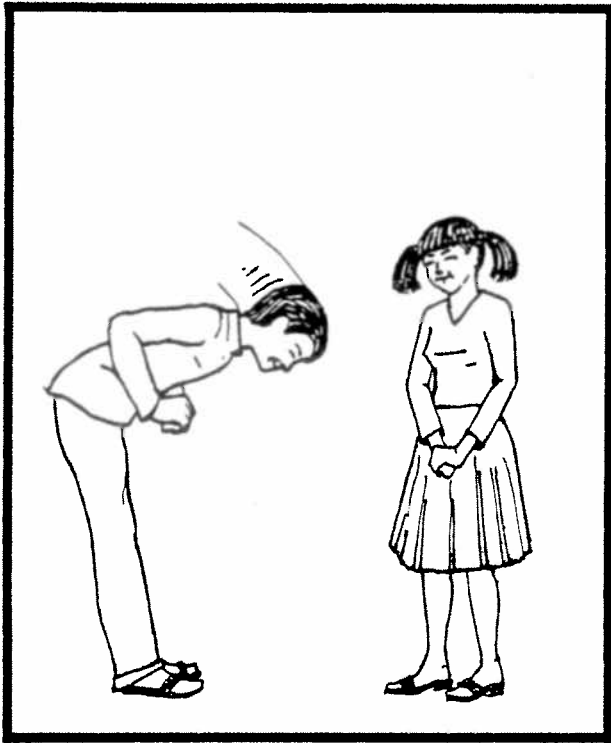

2

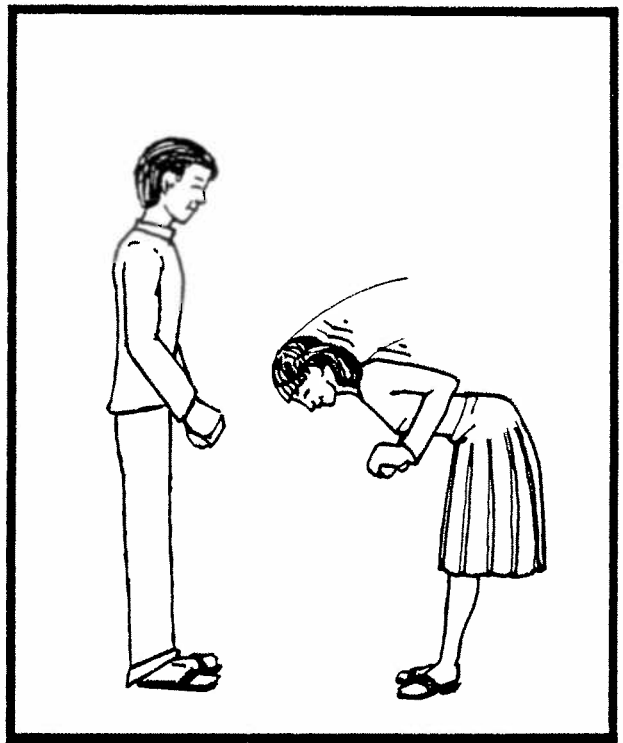

3

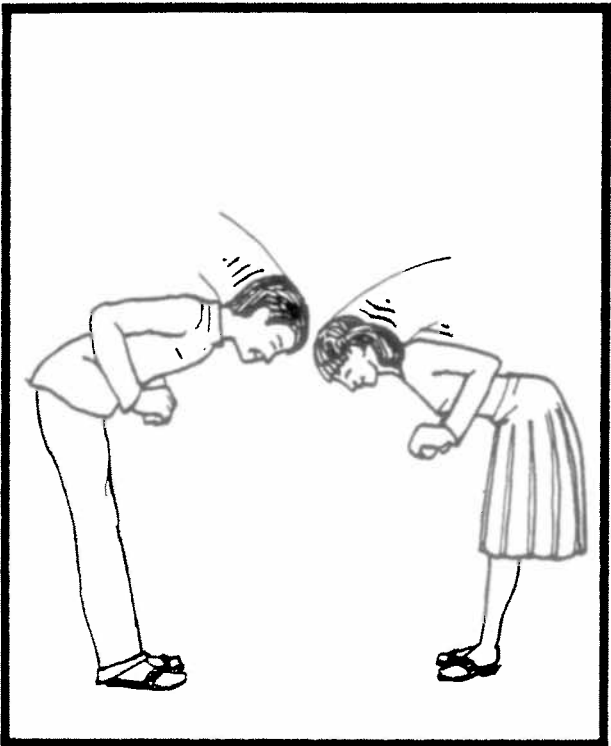

4

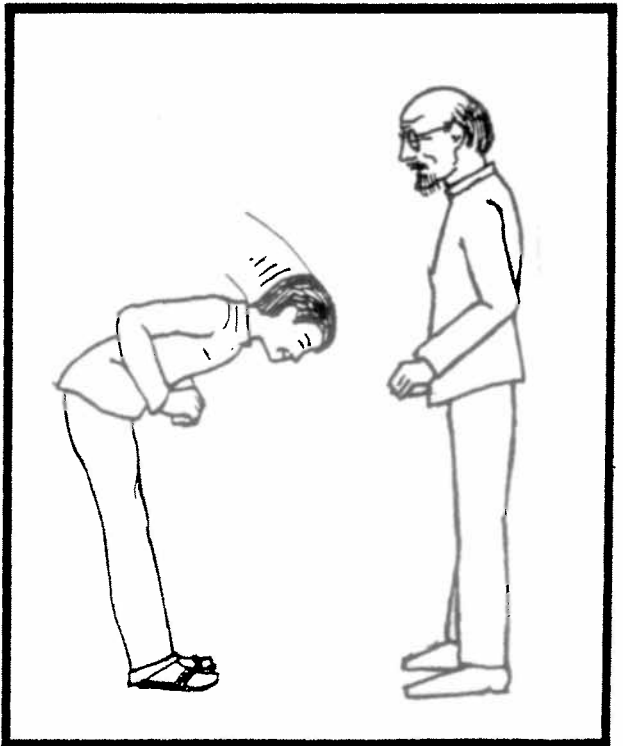

Cậu ta tắm.

1



2

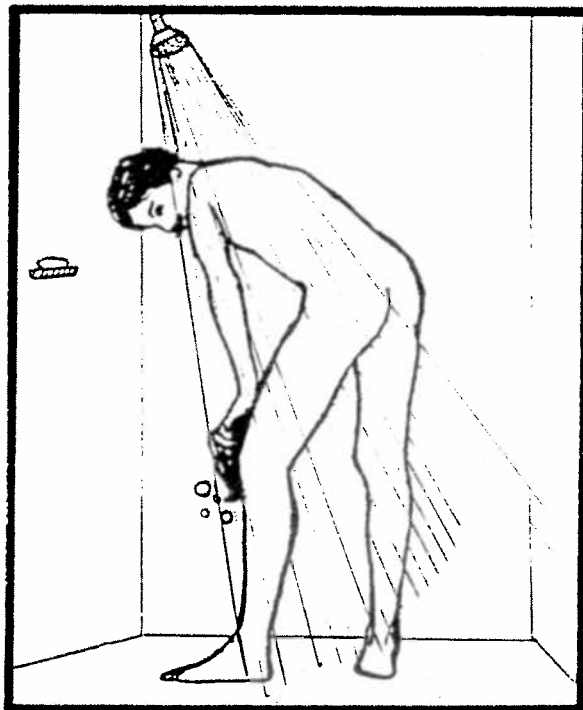

3

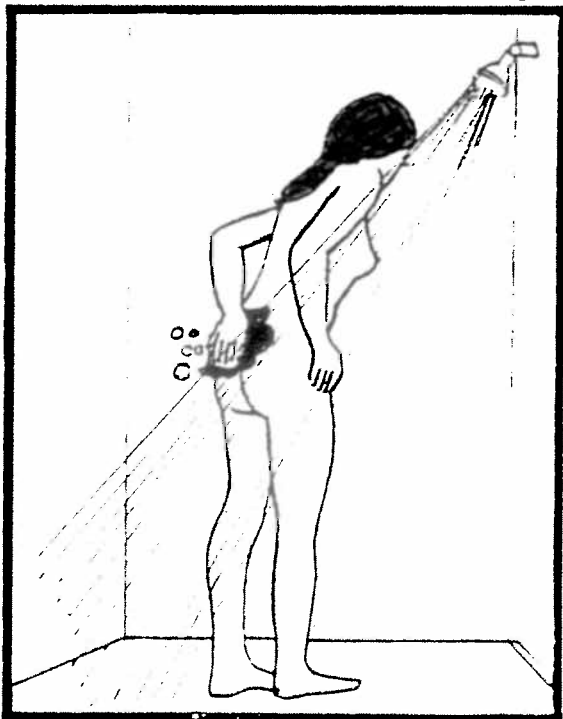

4



Con mèo bị con chó cắn.



1

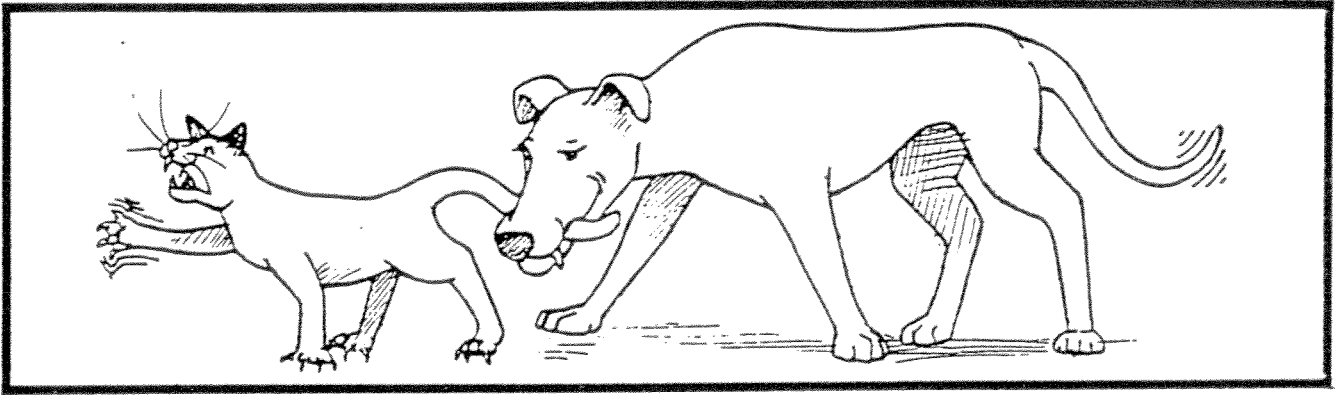

2

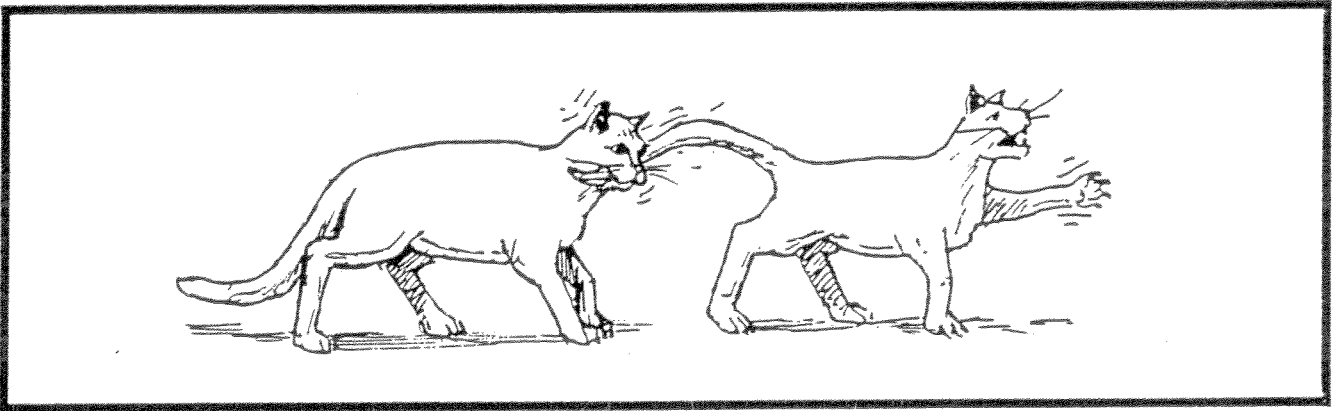

3

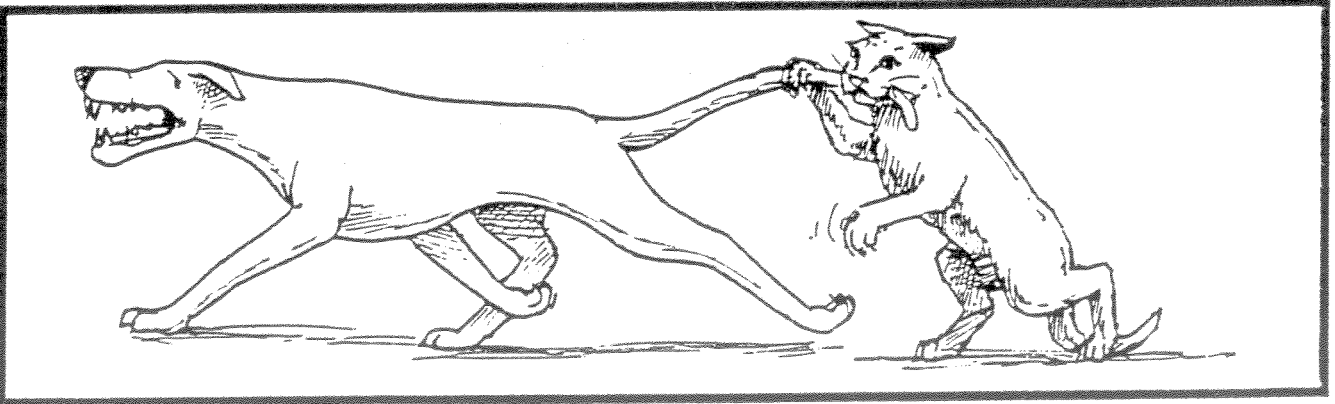

4

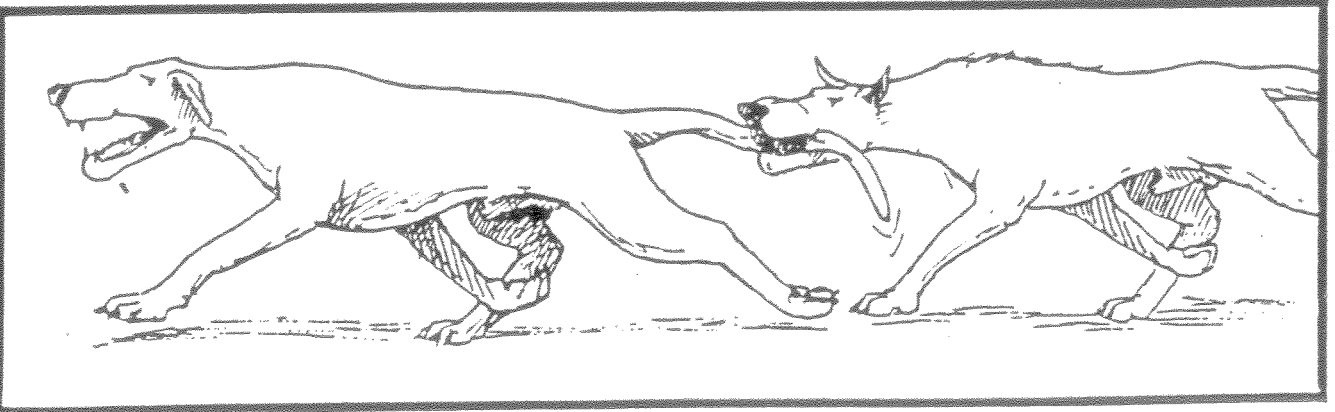

Chính chiếc xe tải kéo chiếc xe hơi.

1

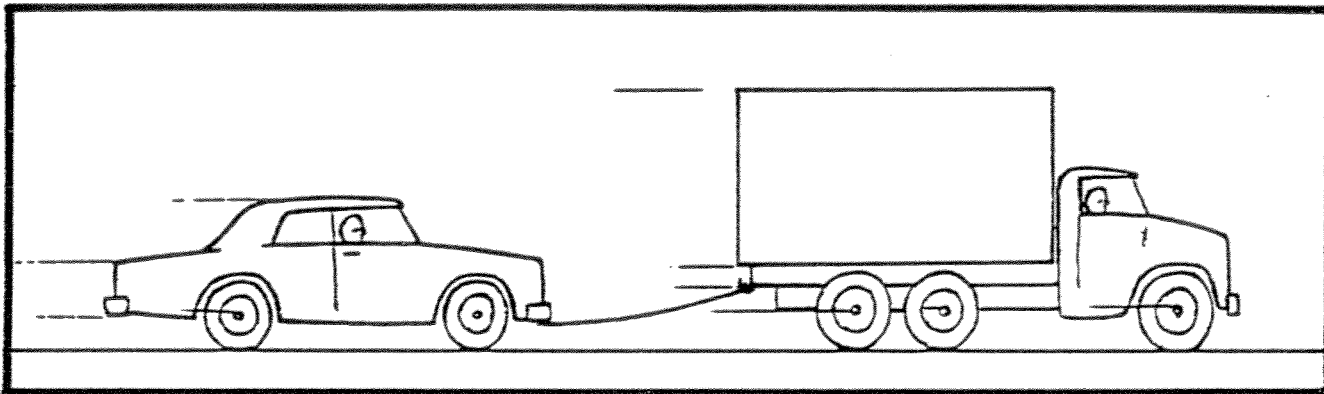

2

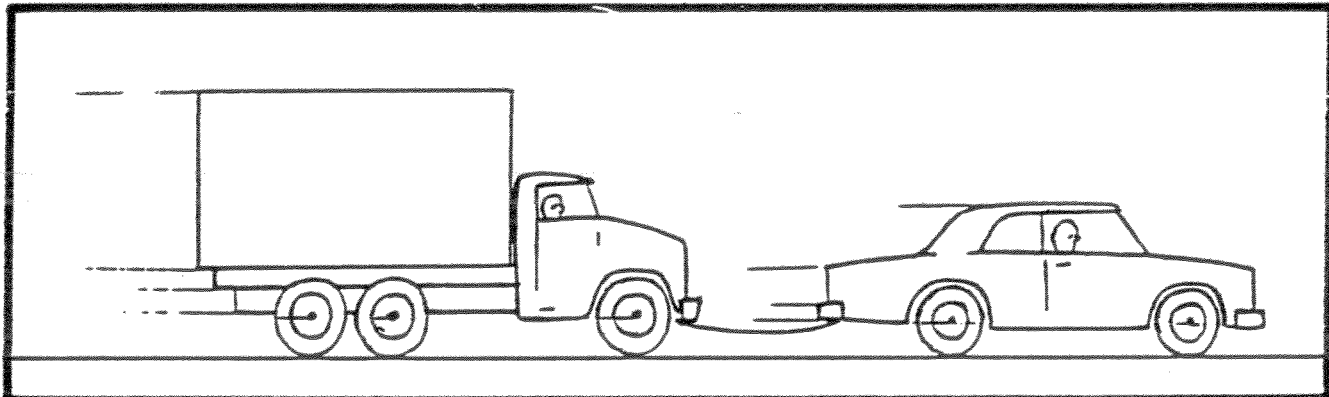

3

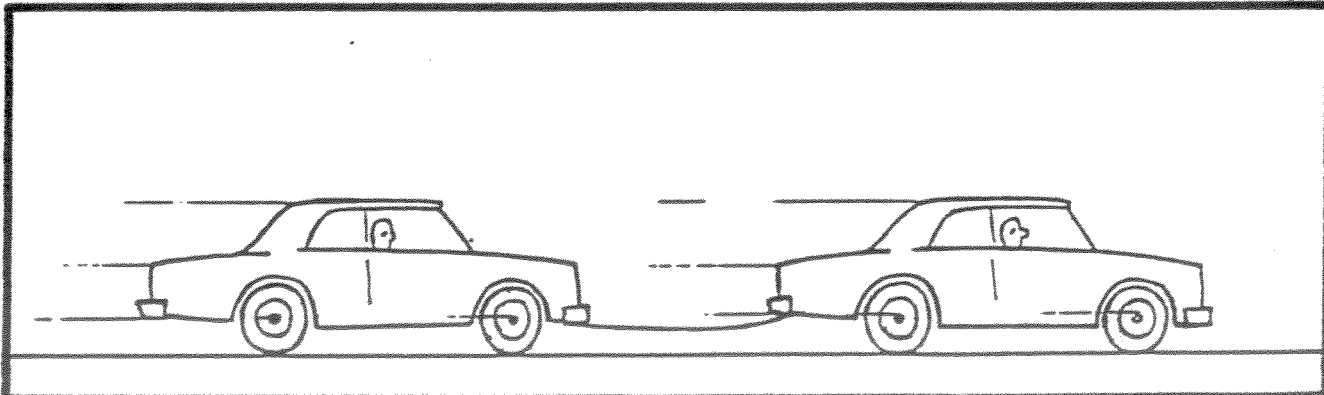

4

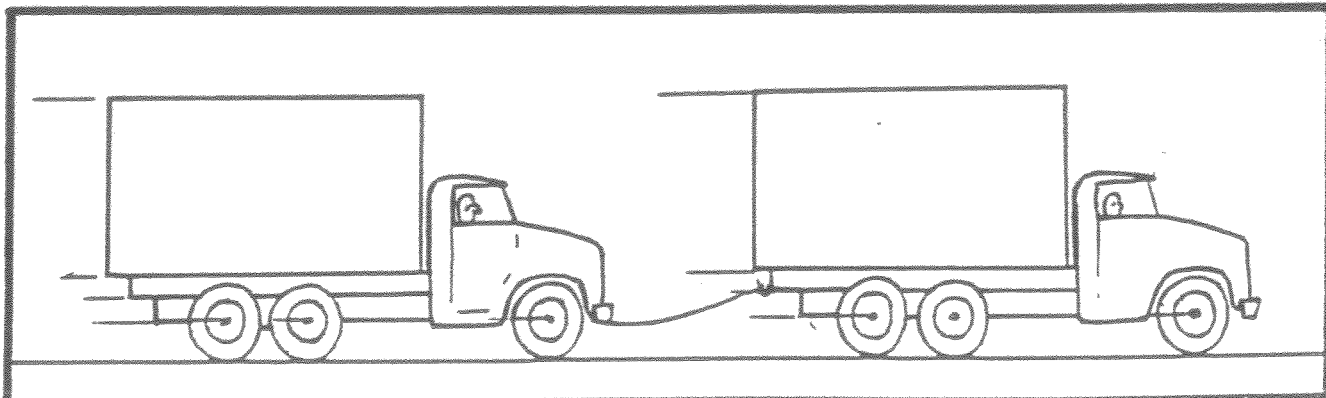

Người con trai không xô người con gái.

1

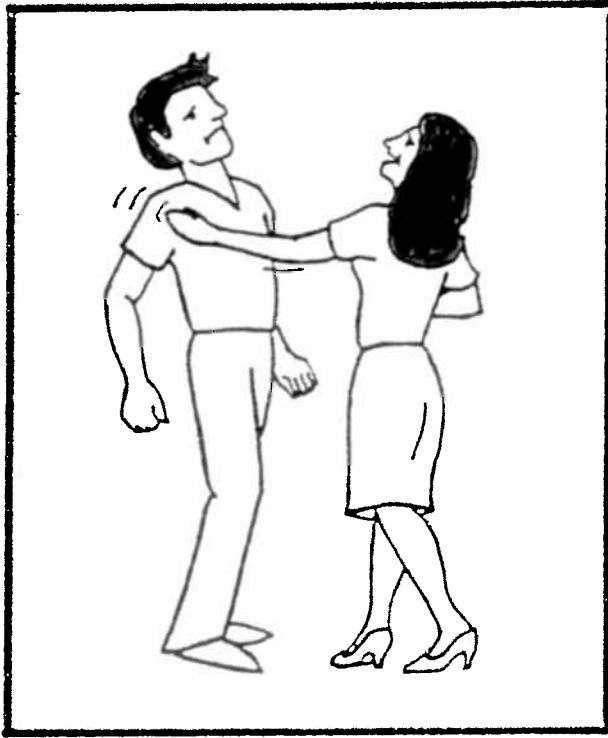

2

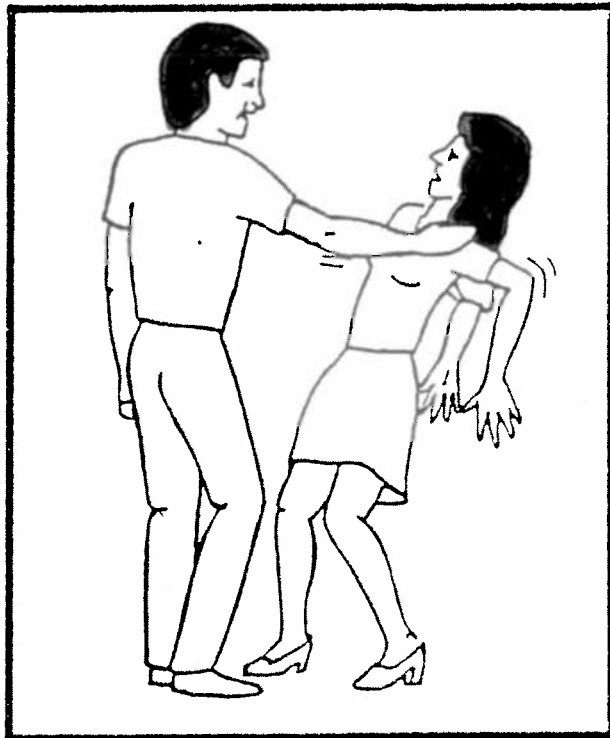

Chiếc xe tải không bị chiếc xe hơi kéo.

1

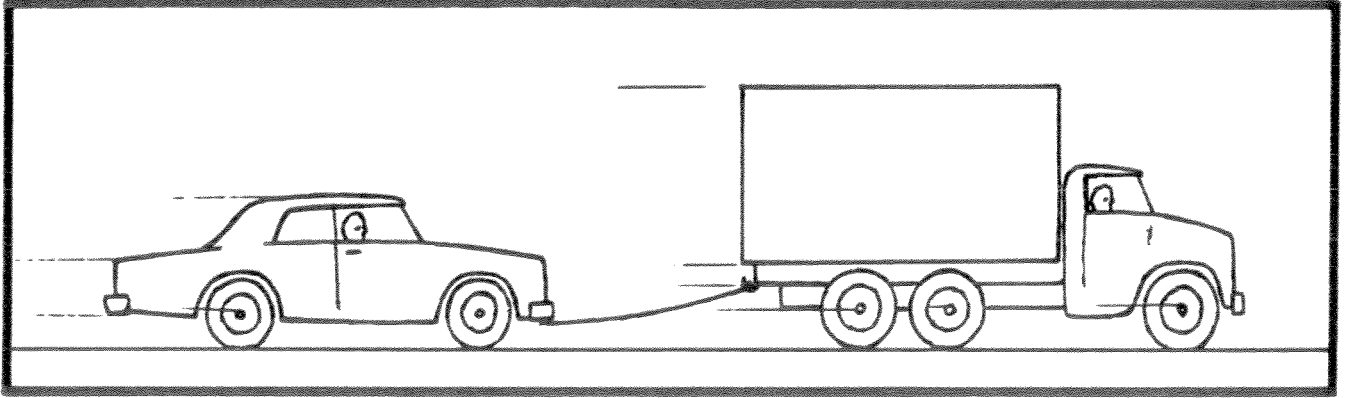

2

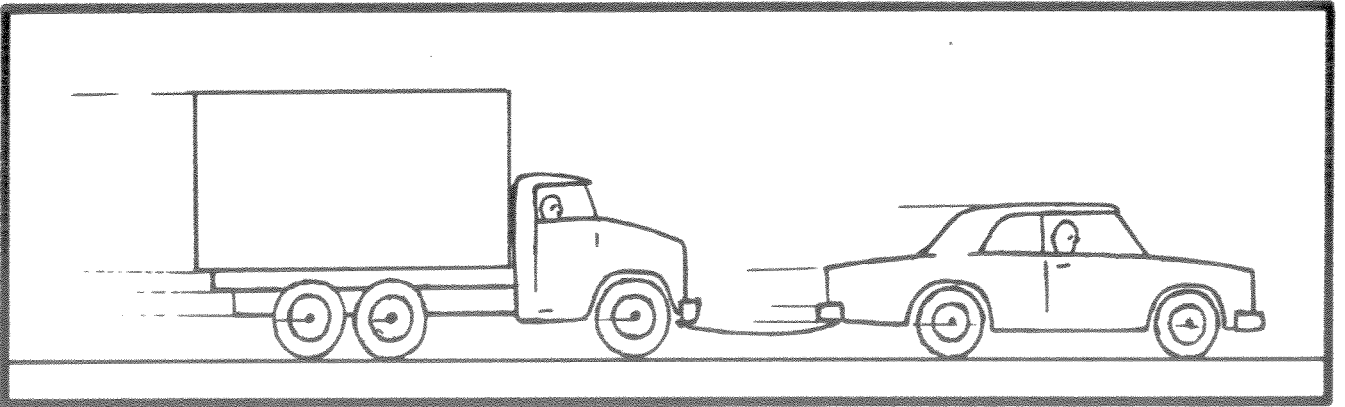

Chính con chó nó bị con mèo cắn.



1

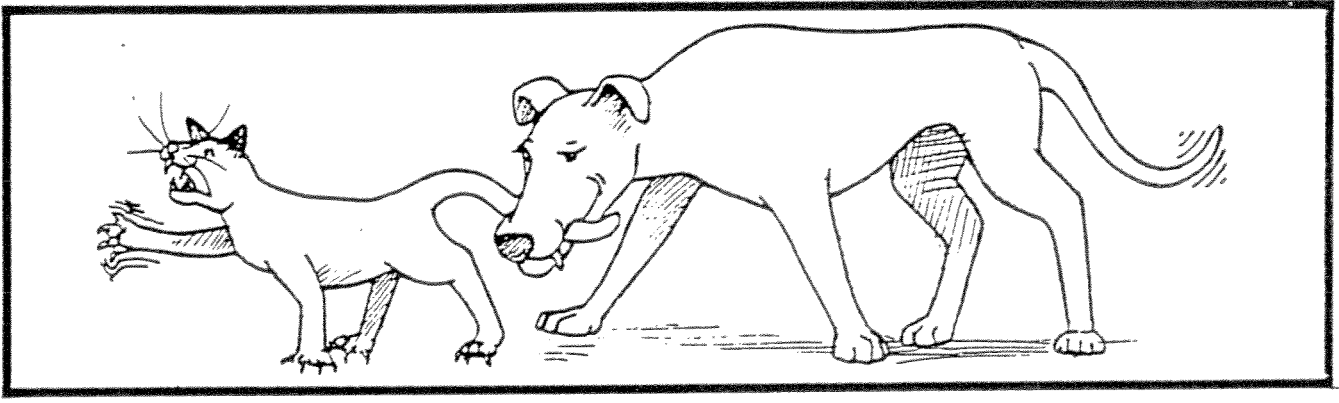

2

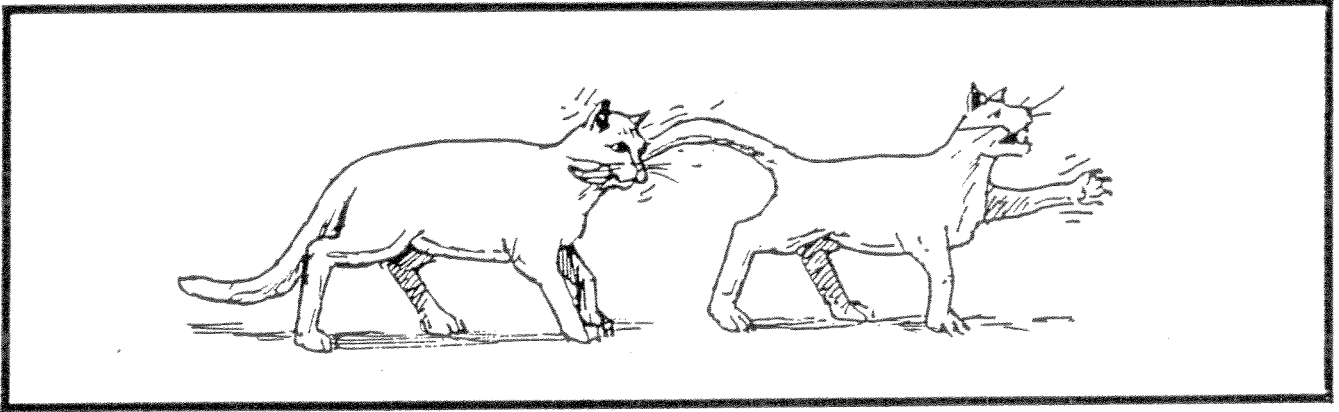

3

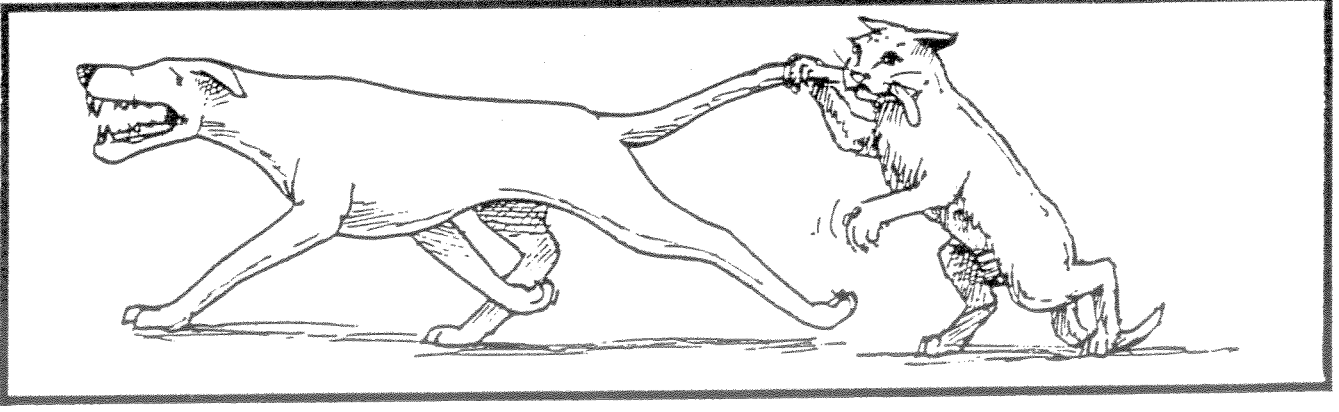

4

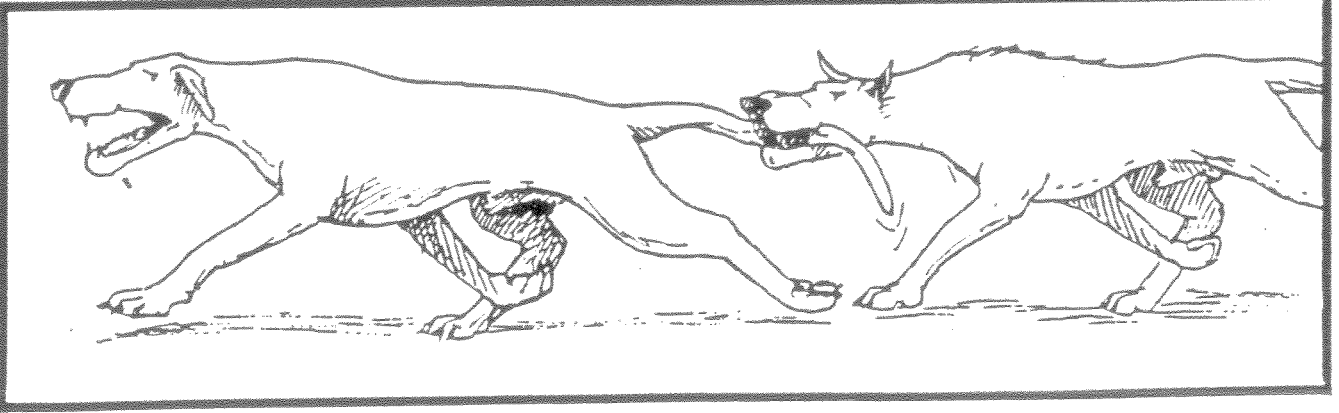

Cô ta chào cậu ta.

1

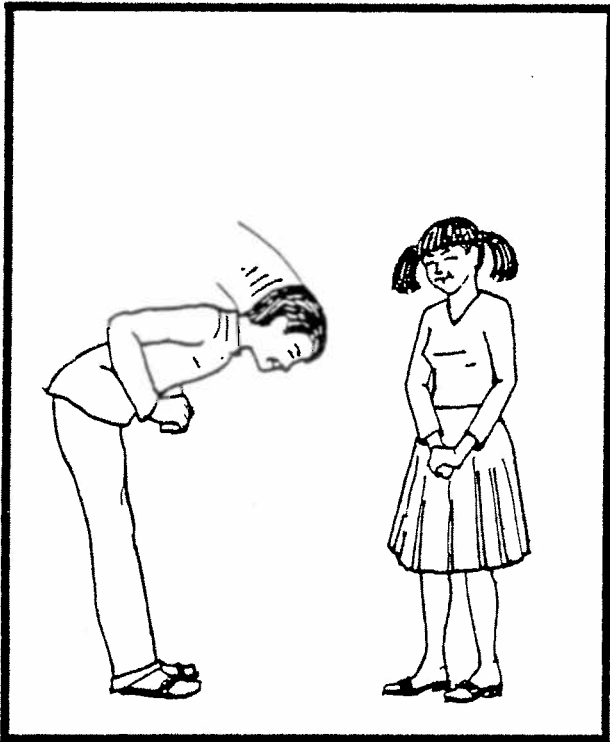

2

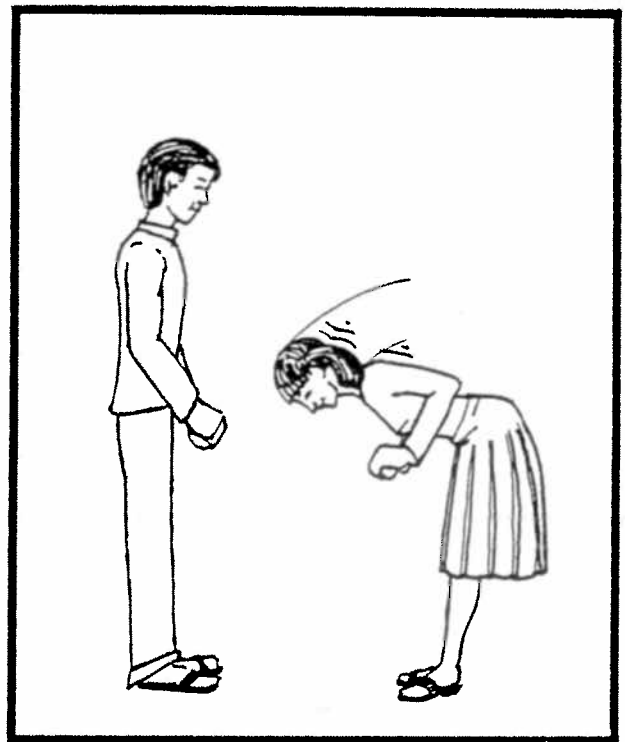

3

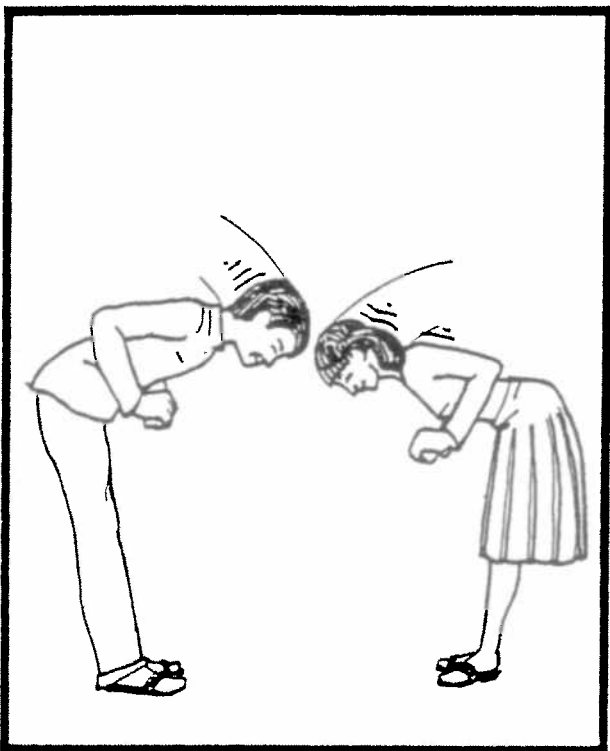

4

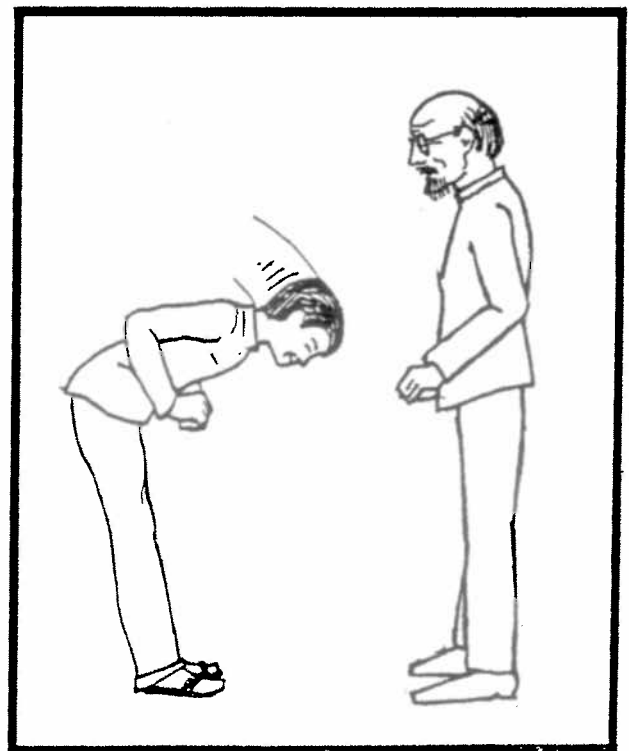

Người con gái bị người con trai xô.

1

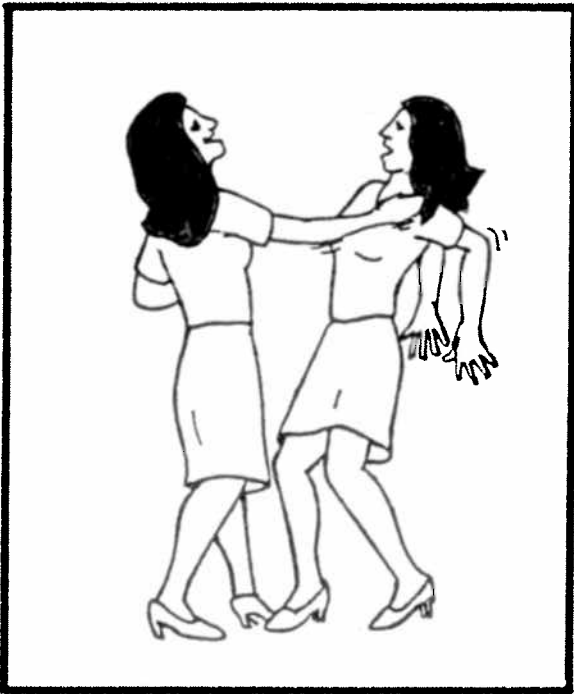

2

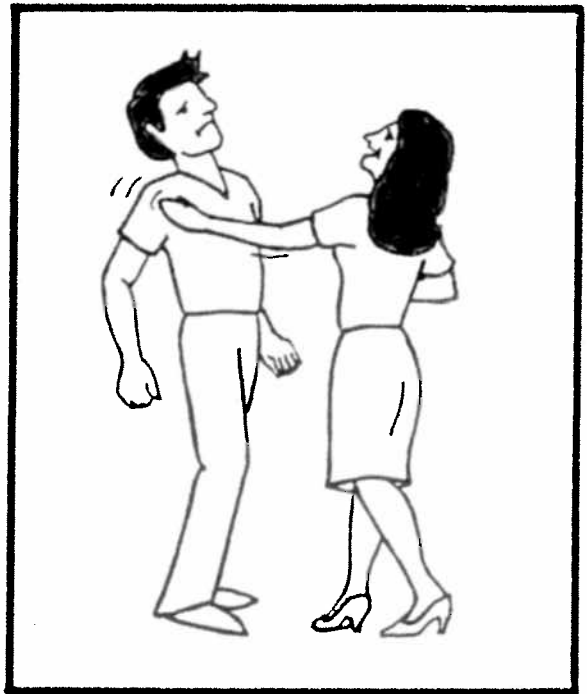

3

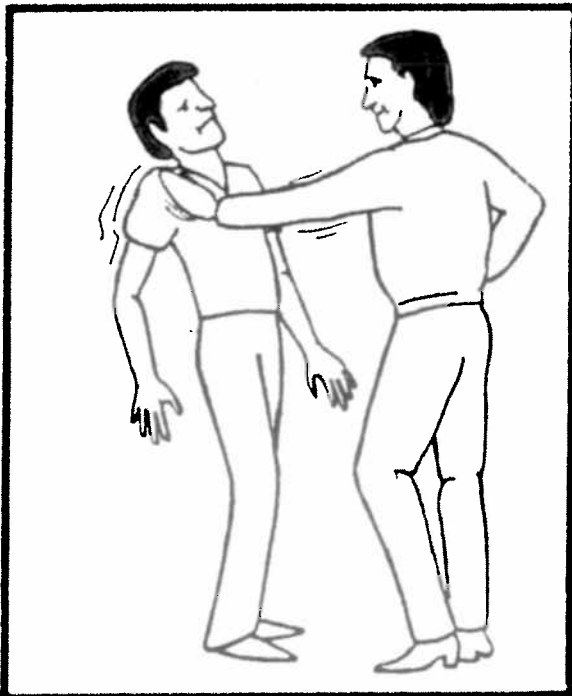

4

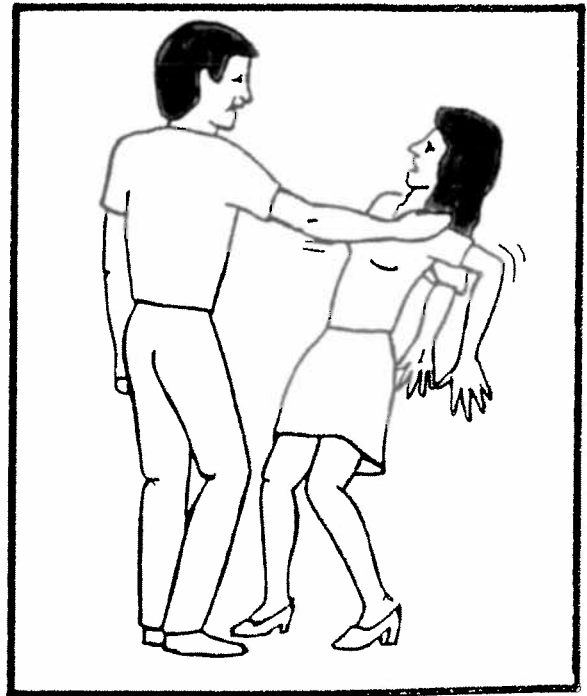

Người con gái không bị người con trai xị nước.

1

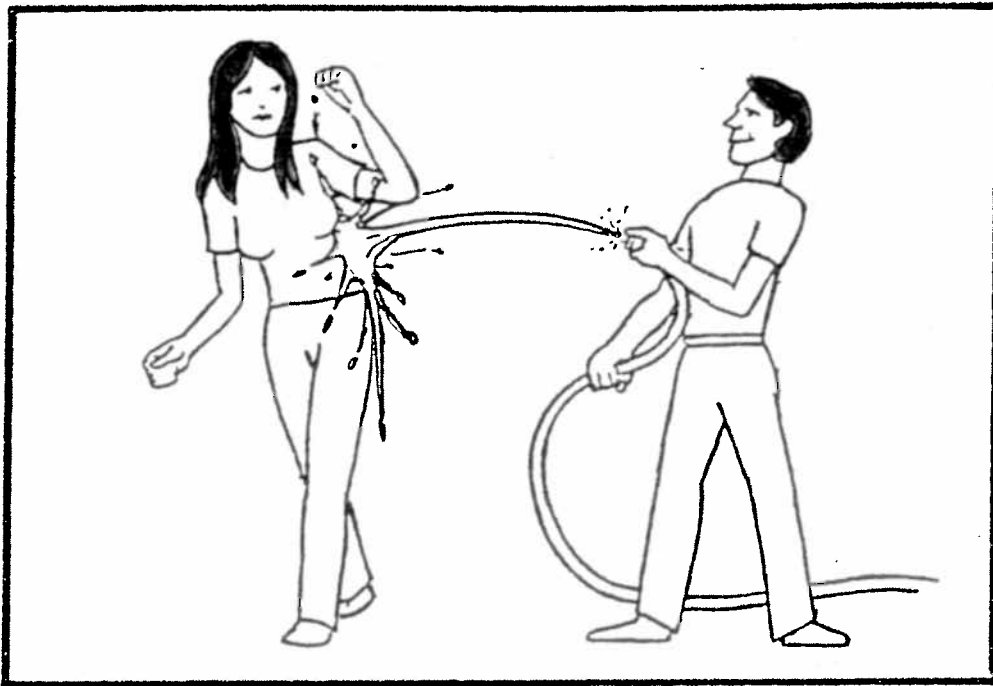

2

