

Michel Paradis
McGill University

BILINGUAL APHASIA TEST

(RUSSIAN VERSION)

STIMULUS BOOK

русский

The development of the Bilingual Aphasia Test materials was supported by Grant MEQ 01-07-k (1976-1983) from the Quebec Ministry of Intergovernmental Affairs, Grant EQ 1660 (1980-1985) from the Quebec Ministry of Education FCAC Fund, and Grants 410-83-1028 (1984, 1985) and 410-88-0821 (1989-1991) from the Social Sciences and Humanities Research Council of Canada.

проверка устной дифференциации

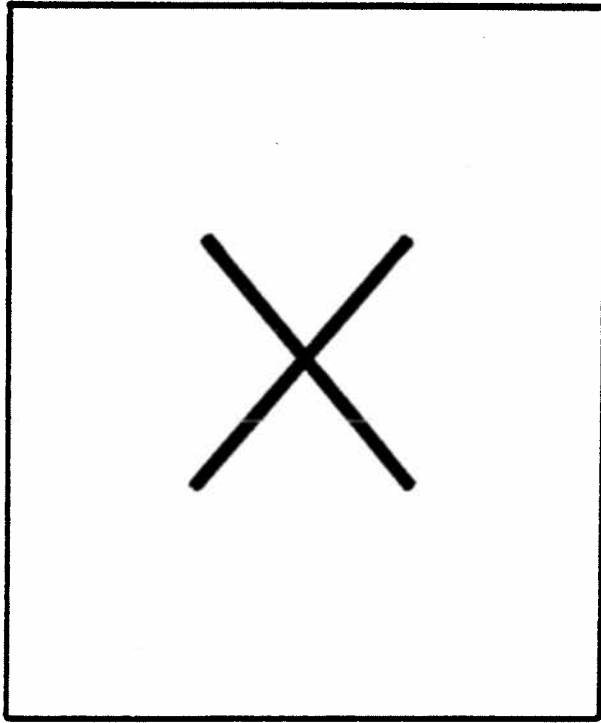

1



2

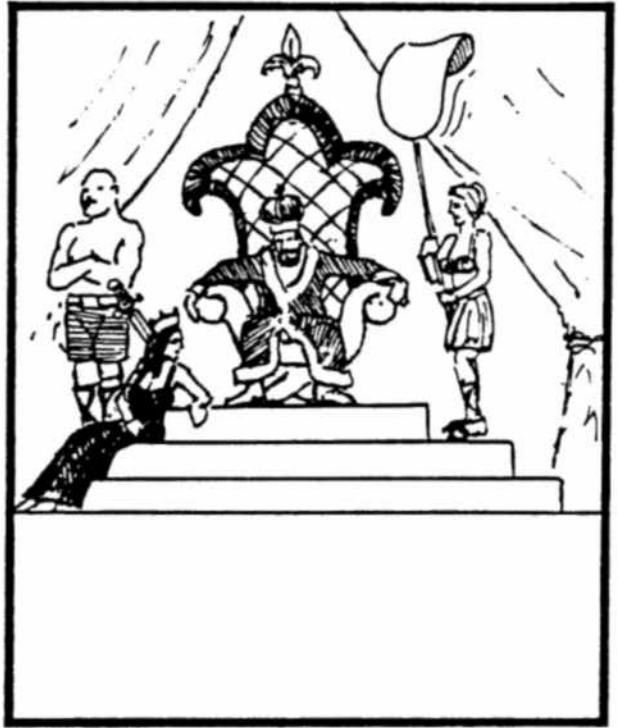

3

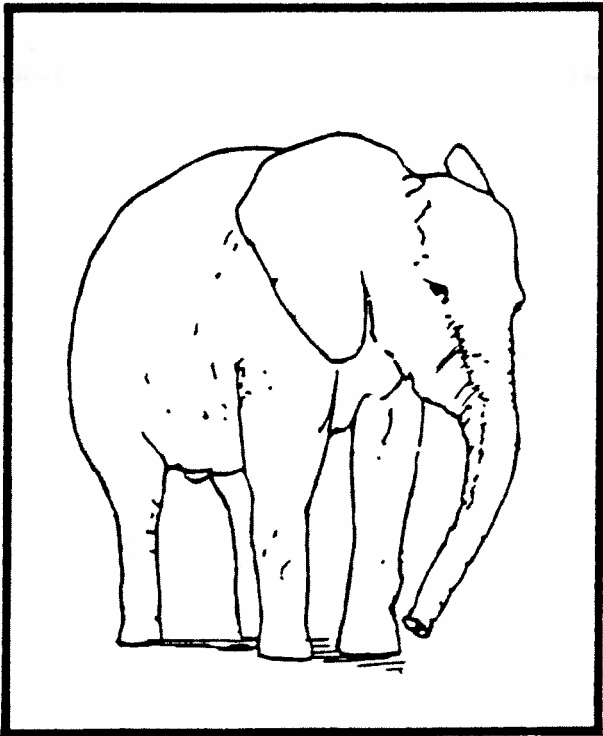

4

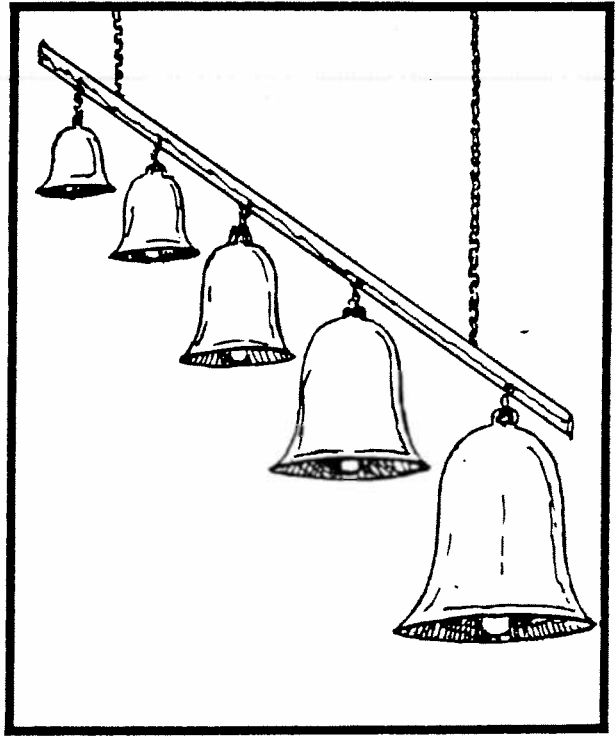

Образец

1

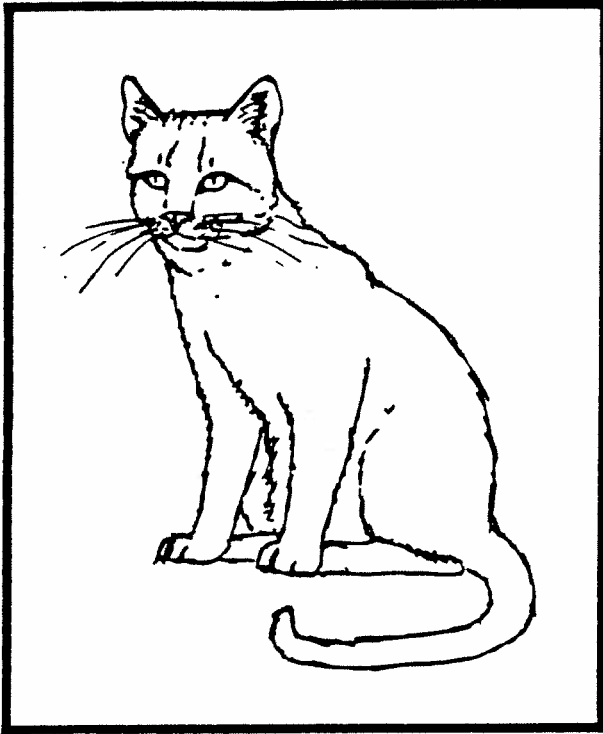

2

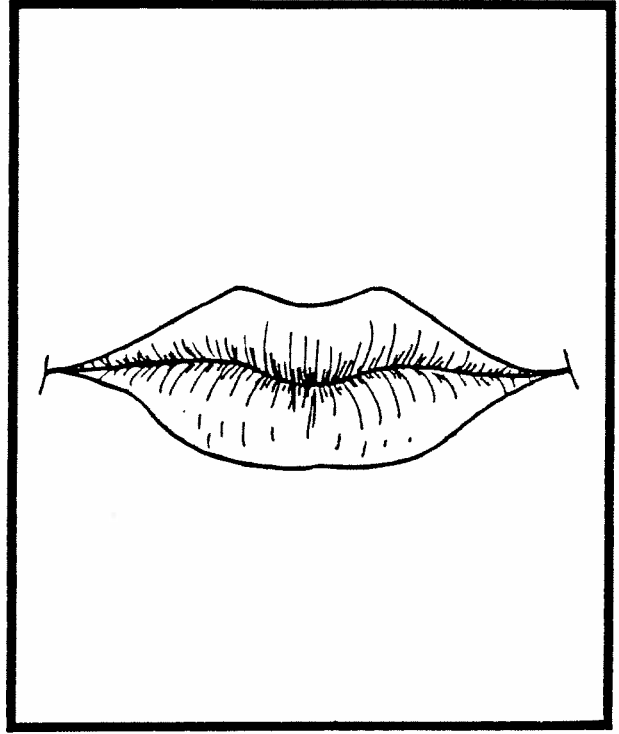

3

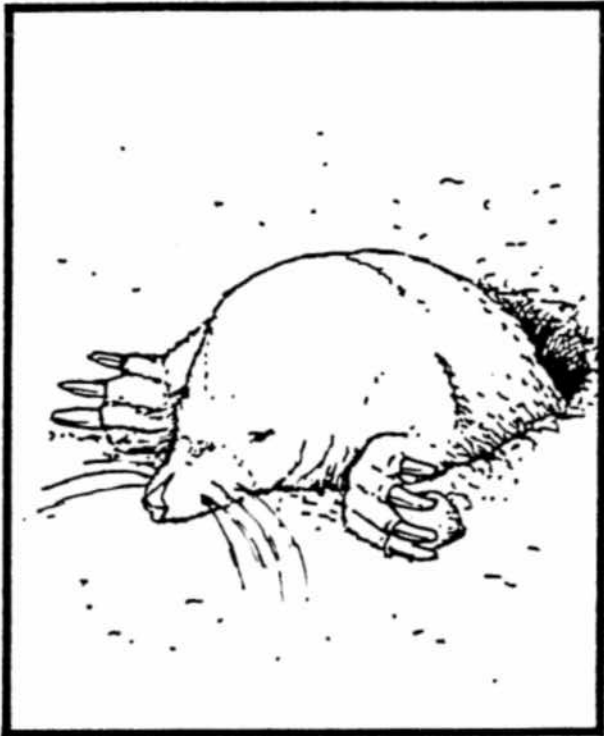

4

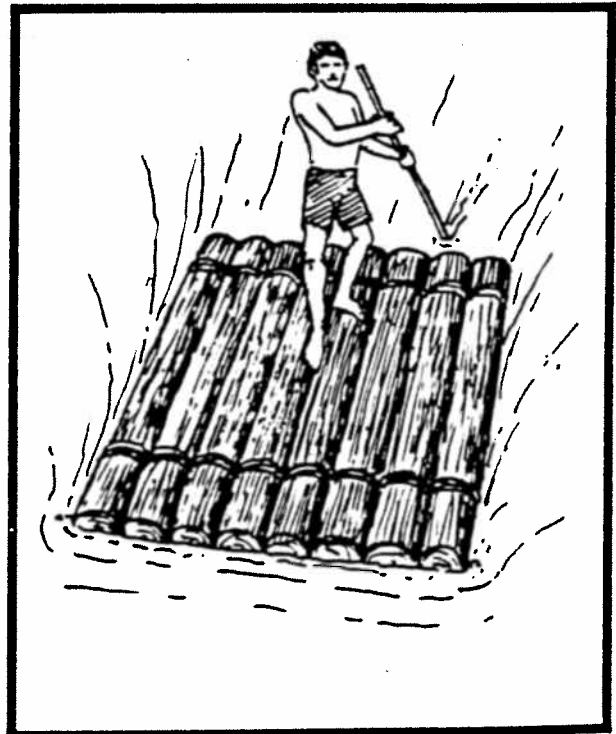

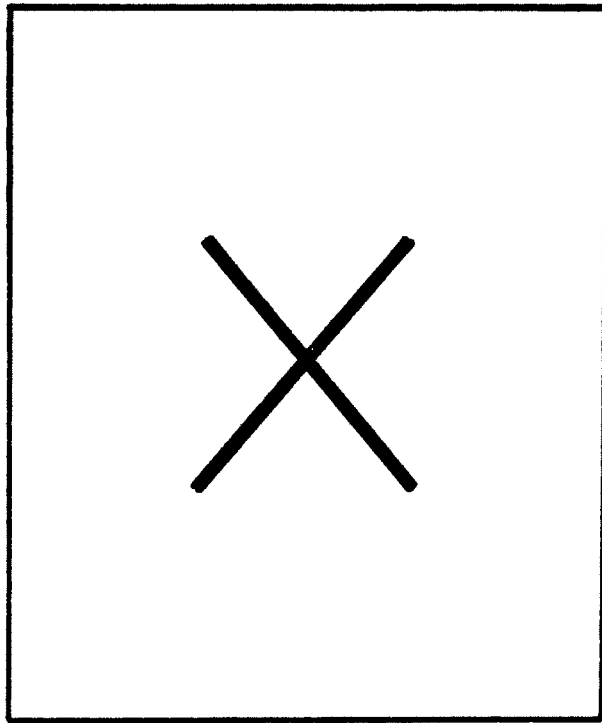

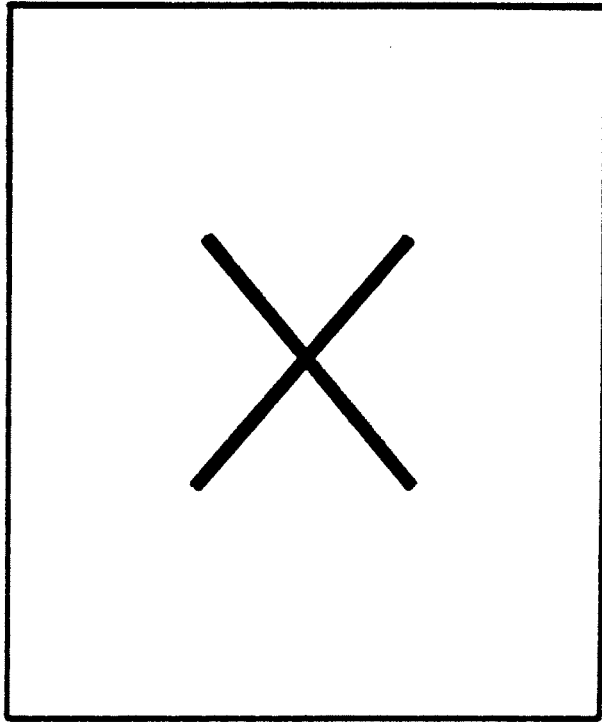

1



2

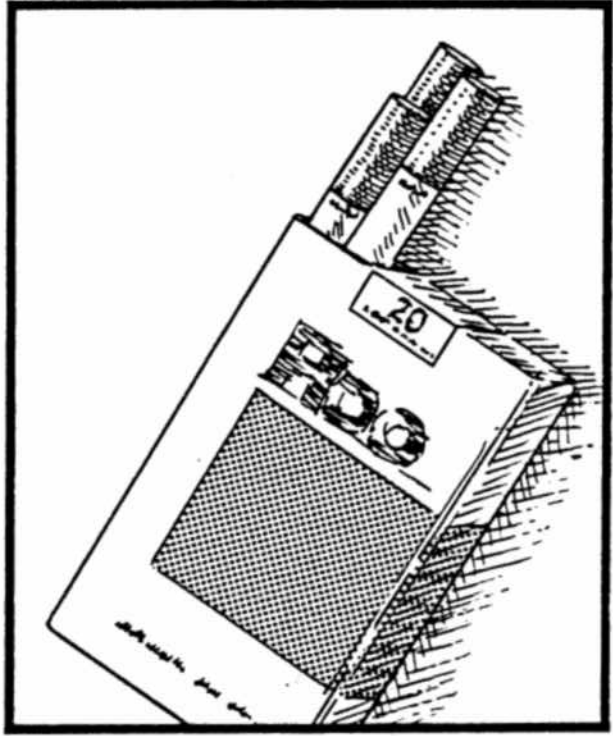

3



4



1

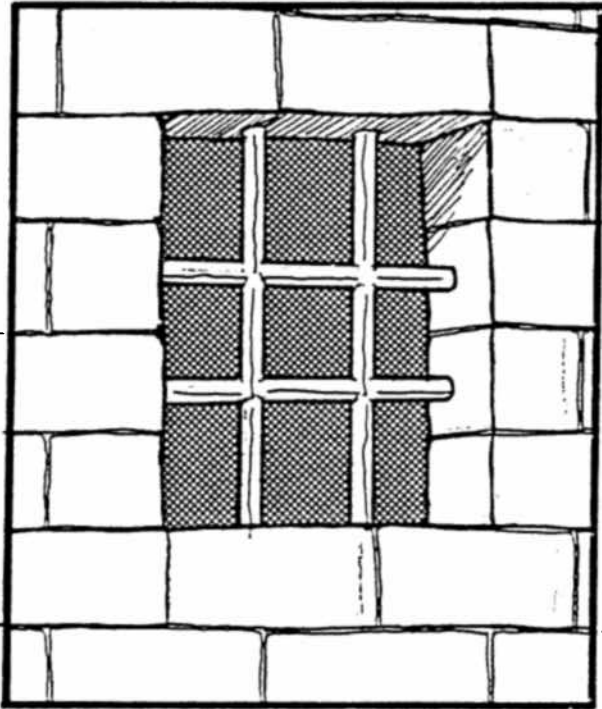

2

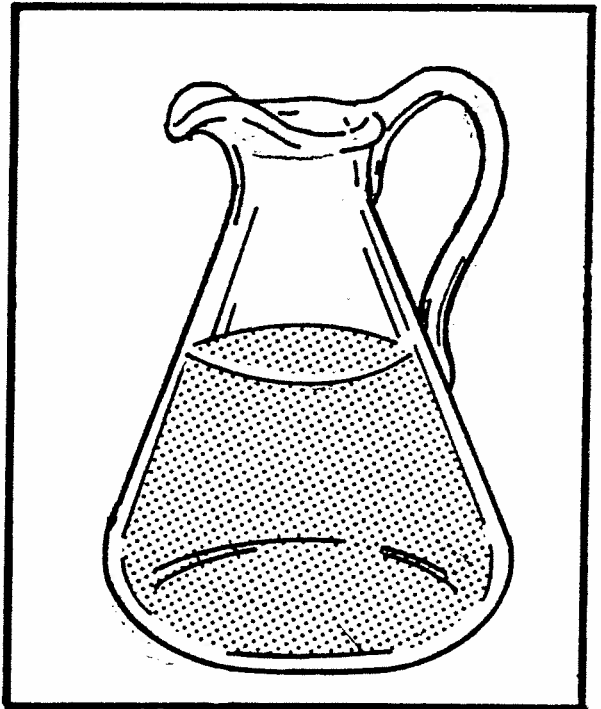

3

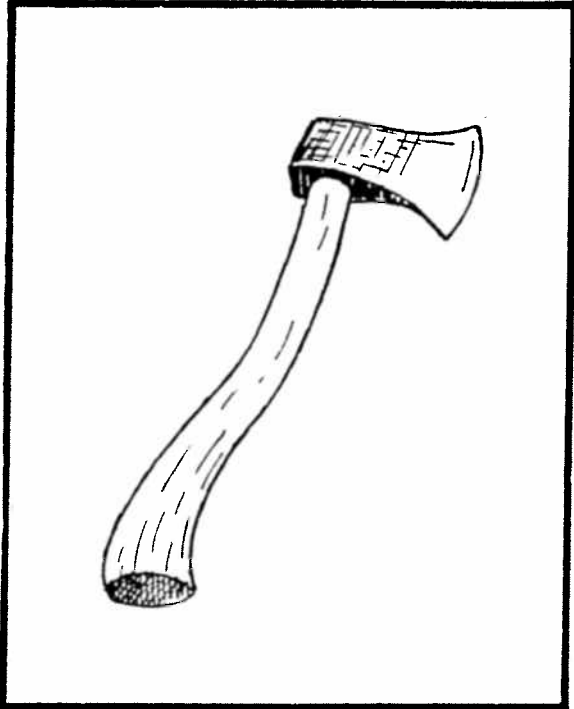

4

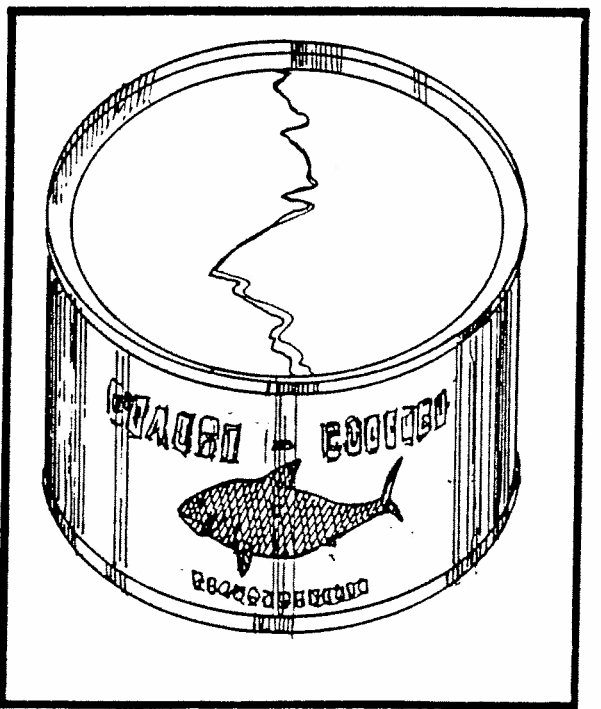

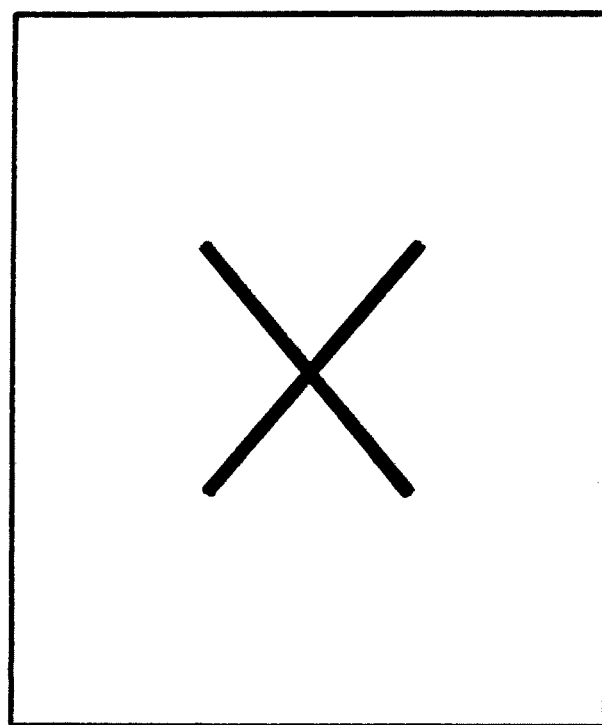

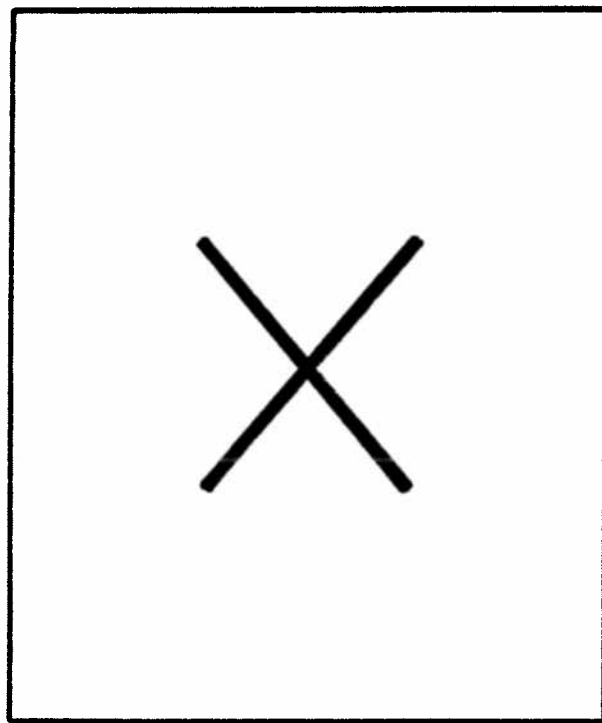

1

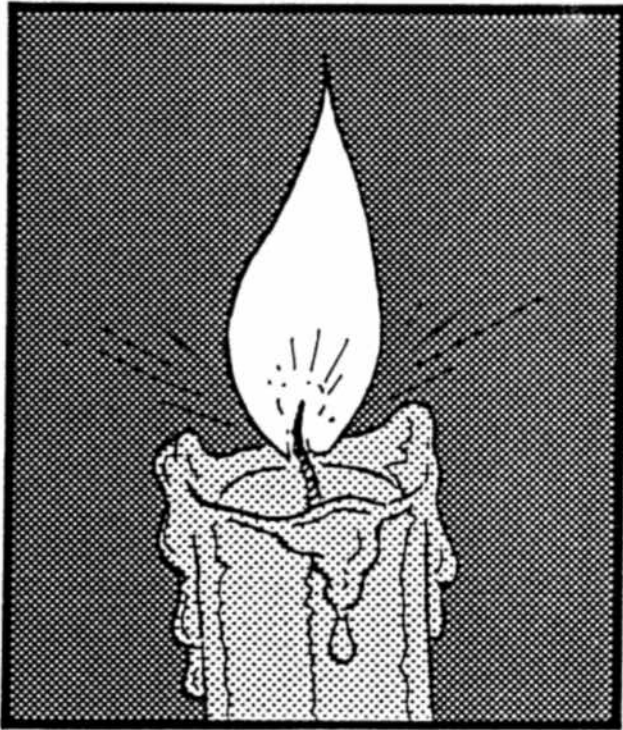

2

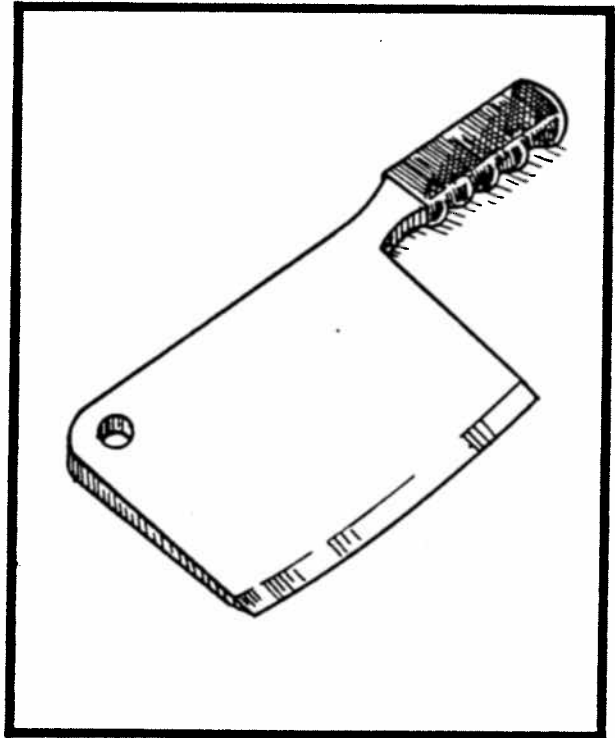

3

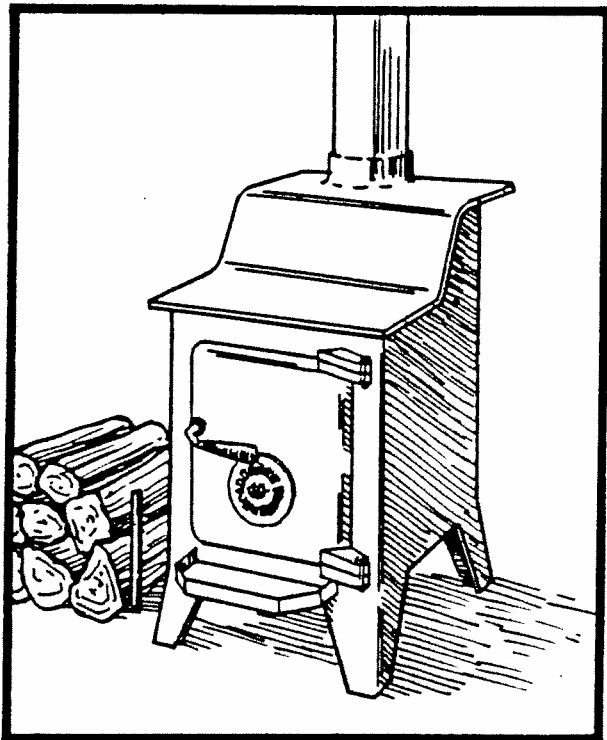

4



1

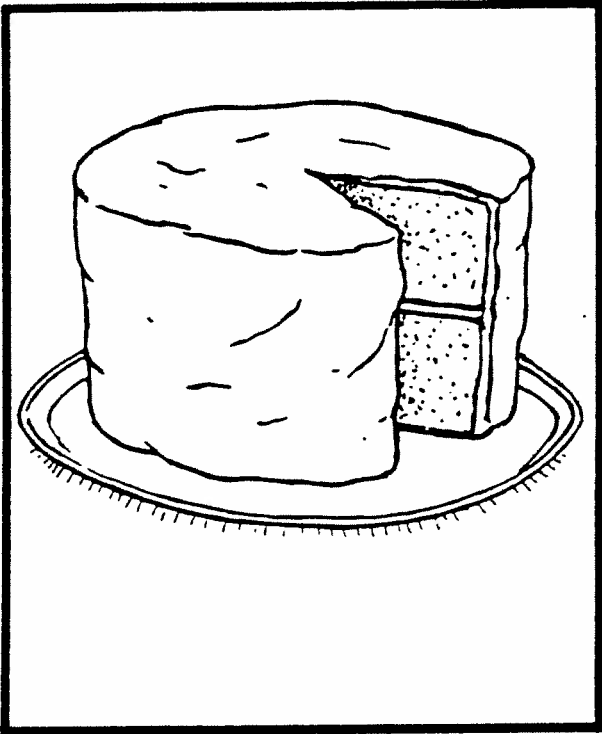

2

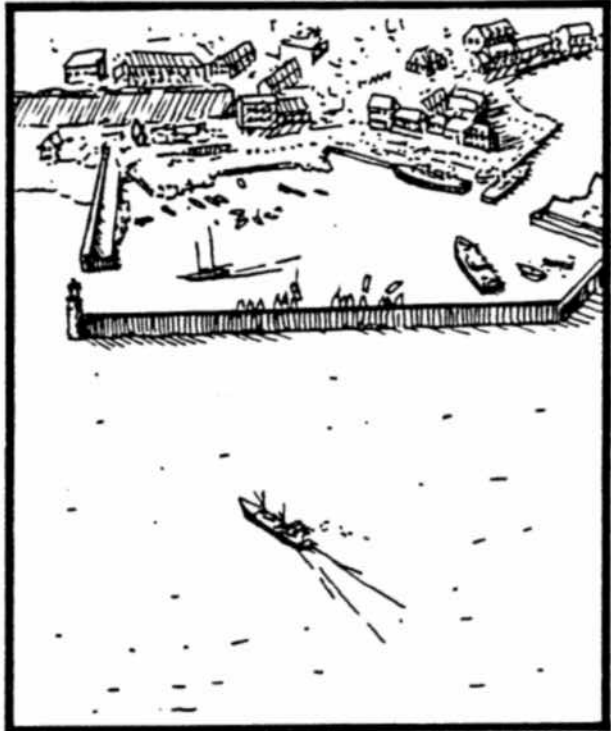

3

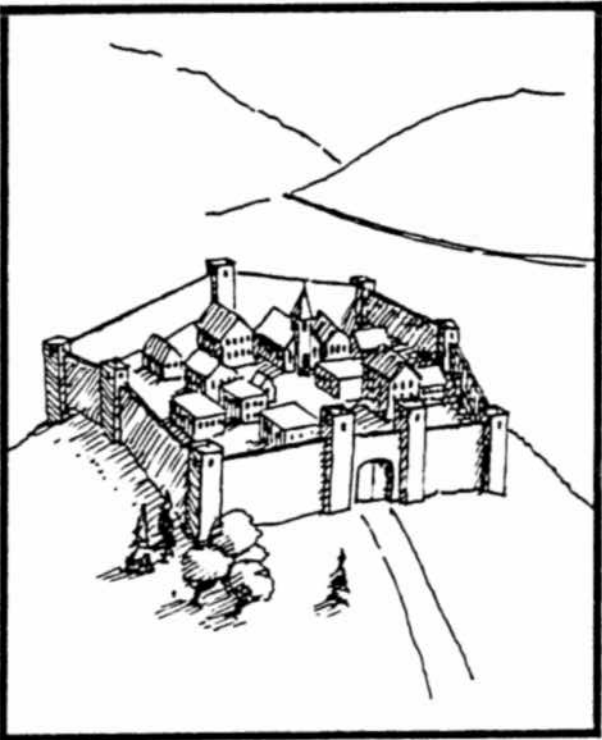

4

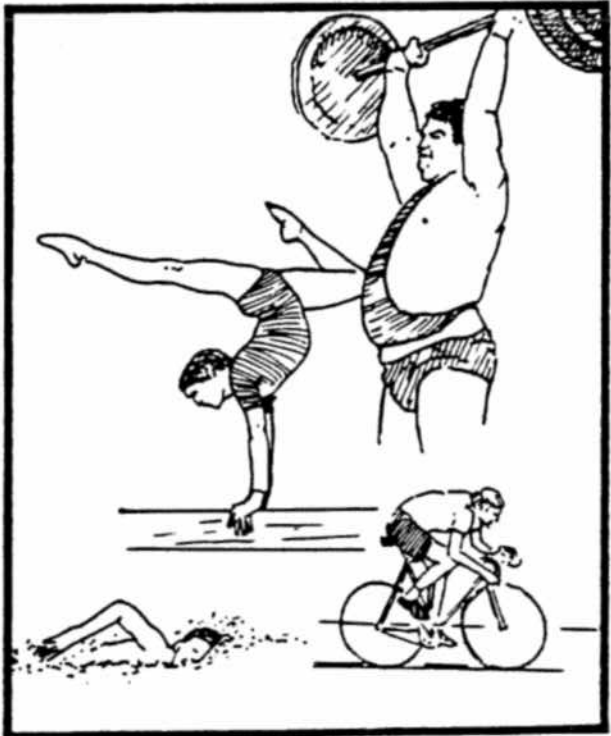

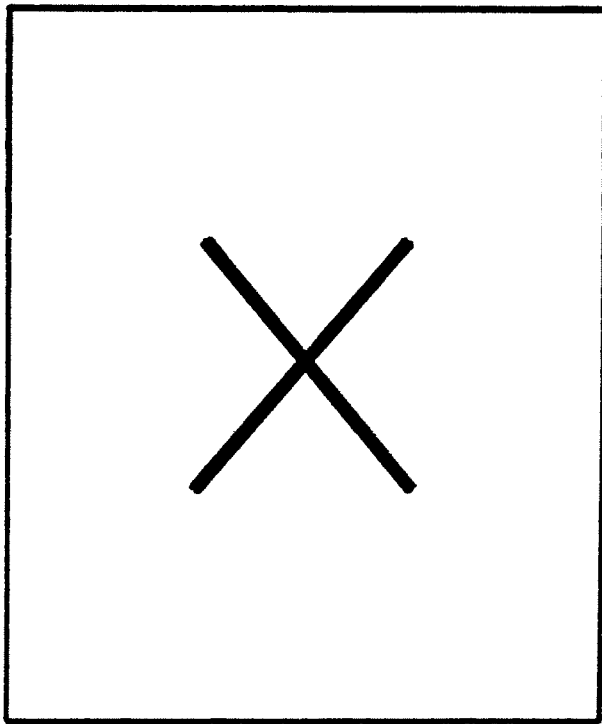

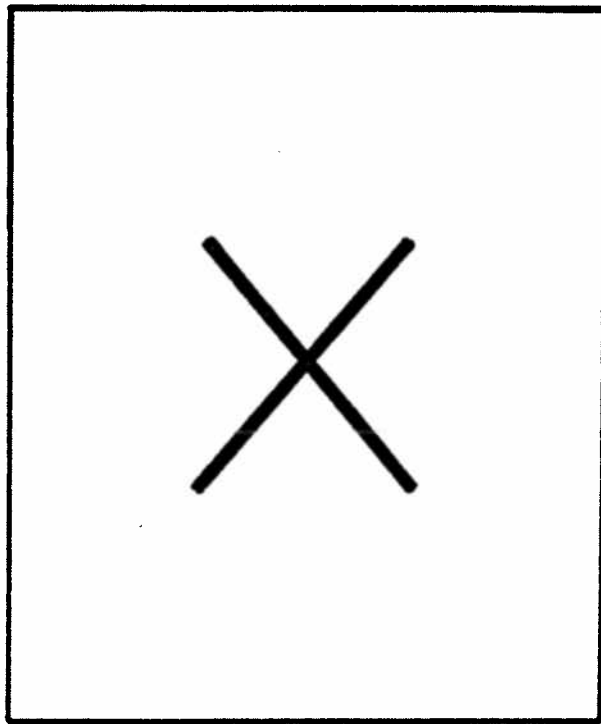

1



2

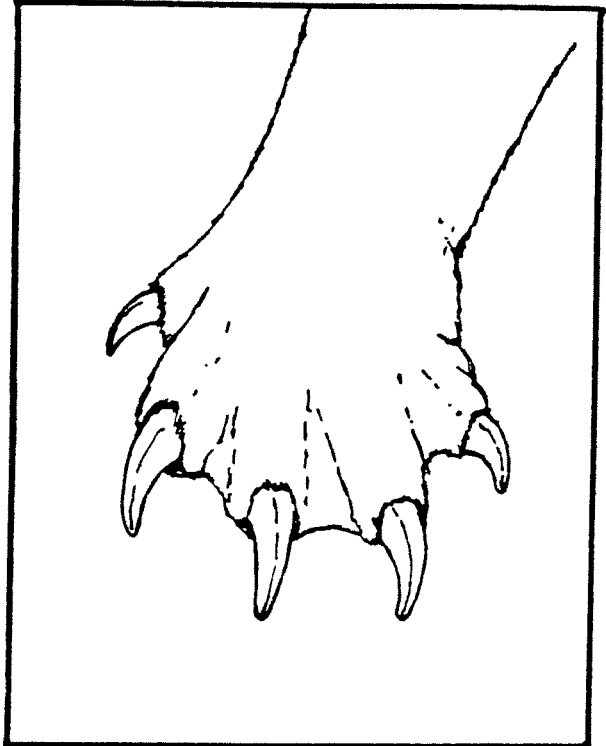

3

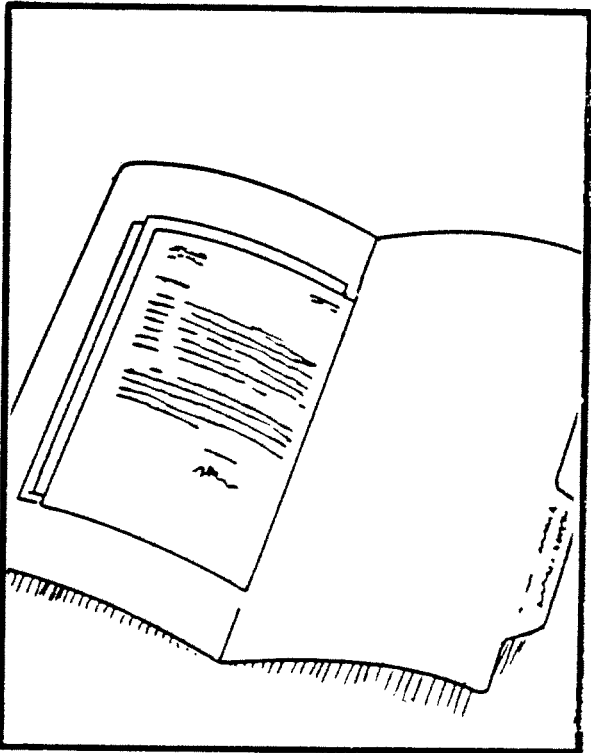

4



1

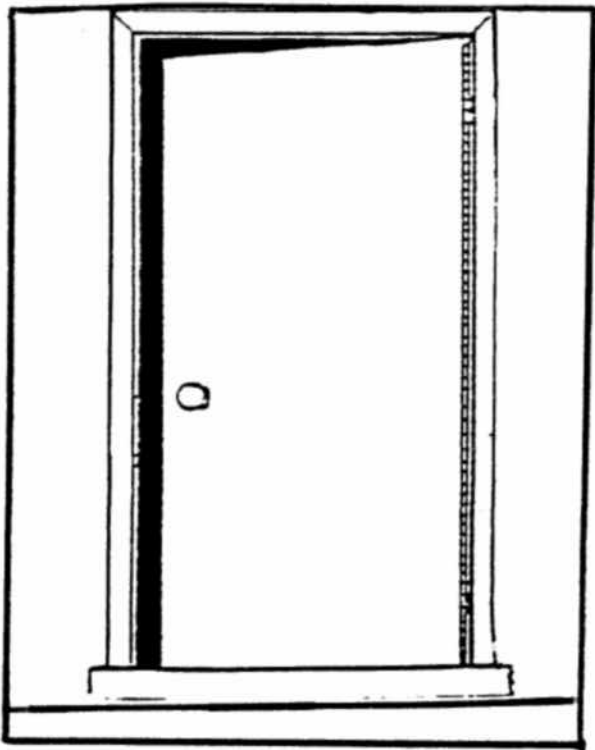

2

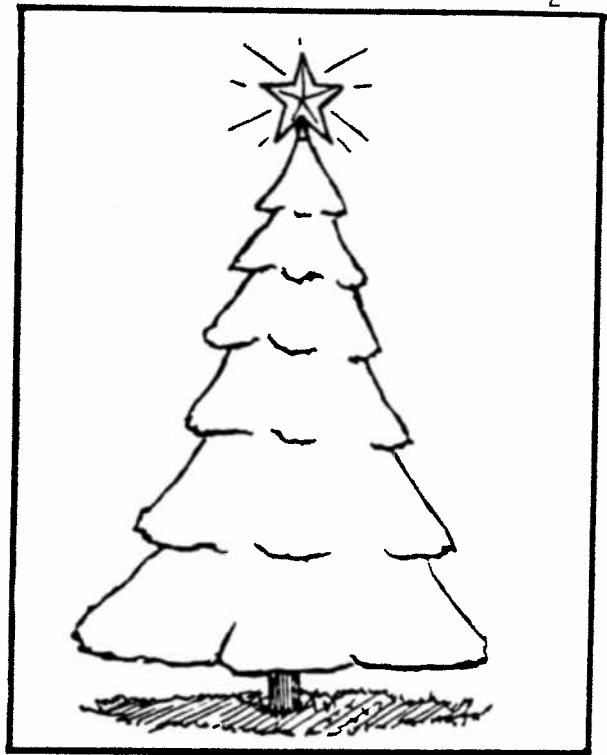

3

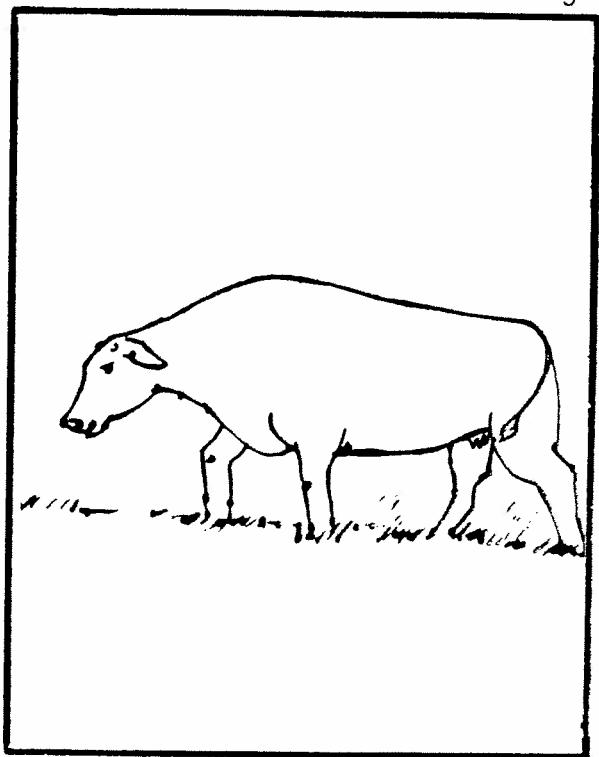

4

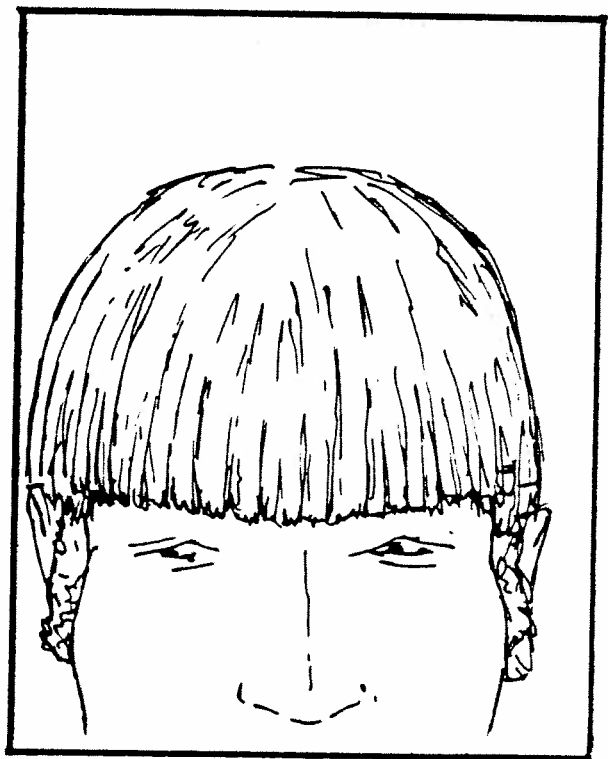

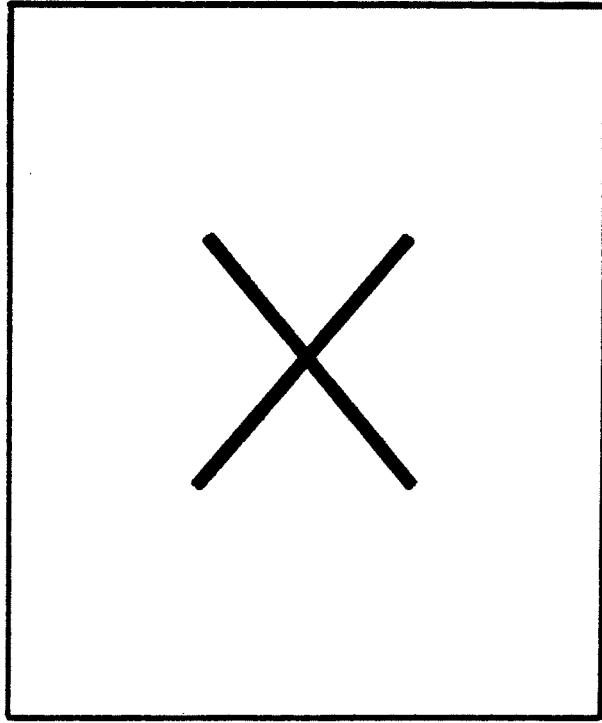

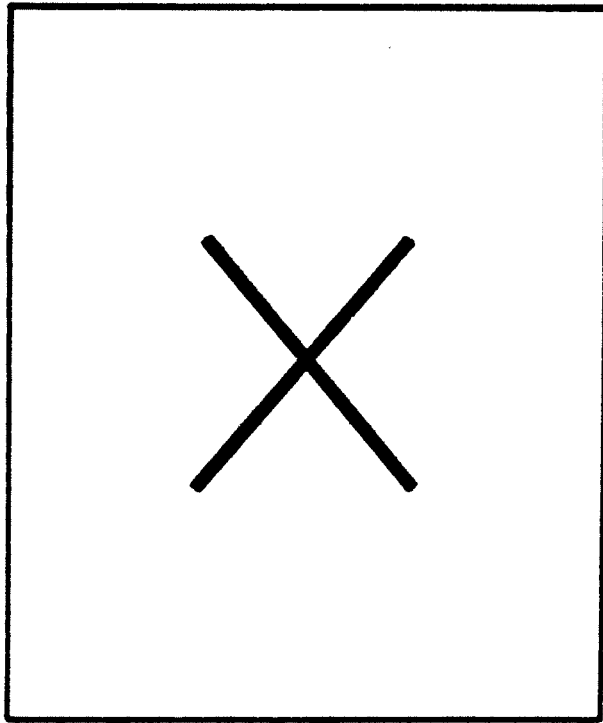

1

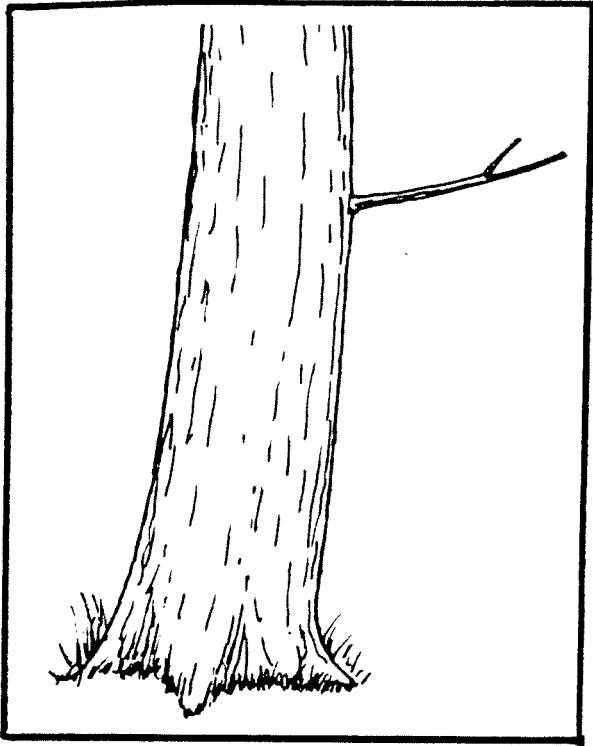

2

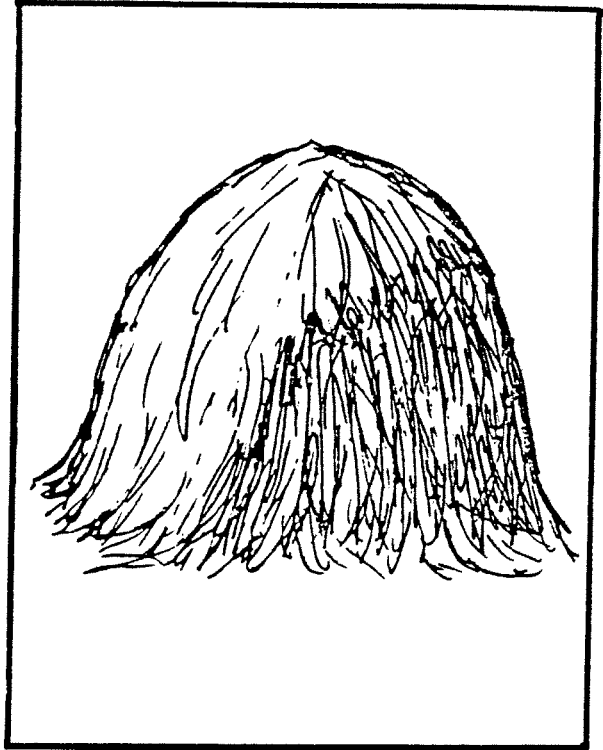

3

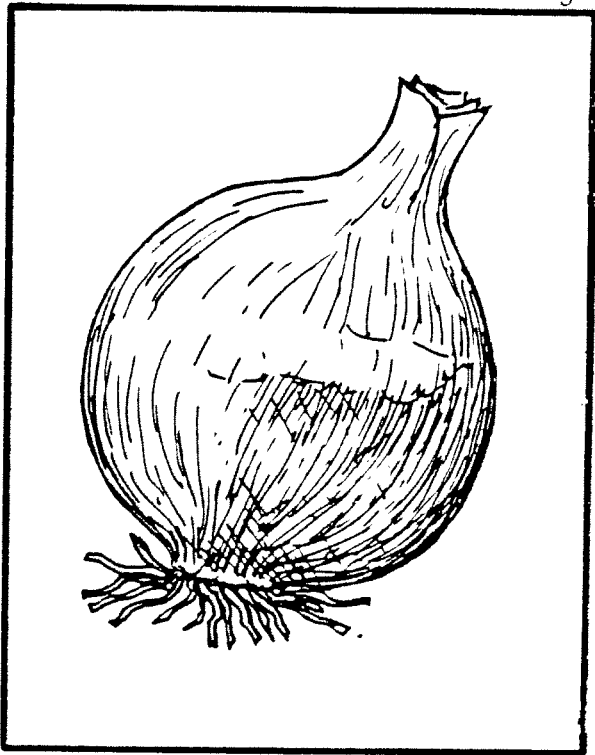

4

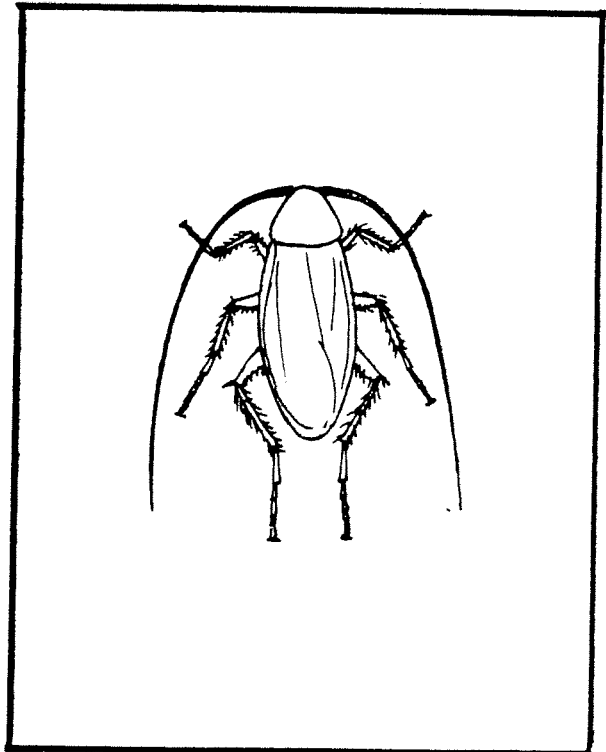

1

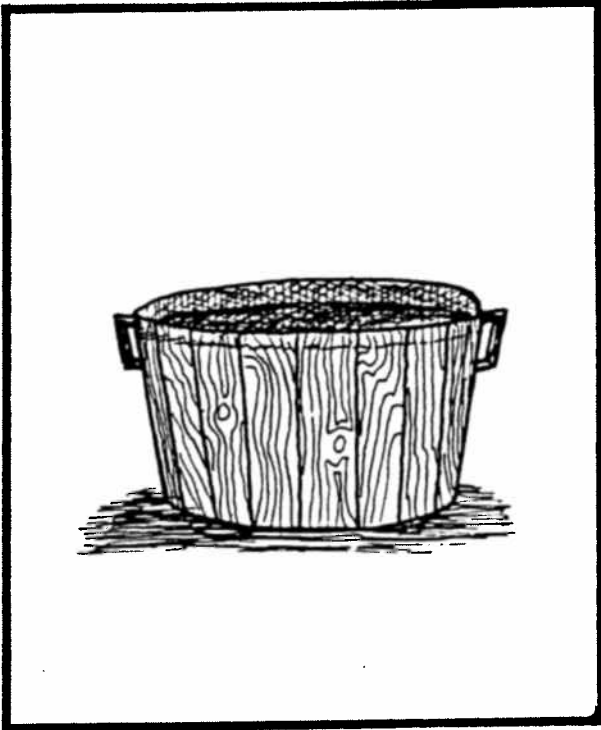

2

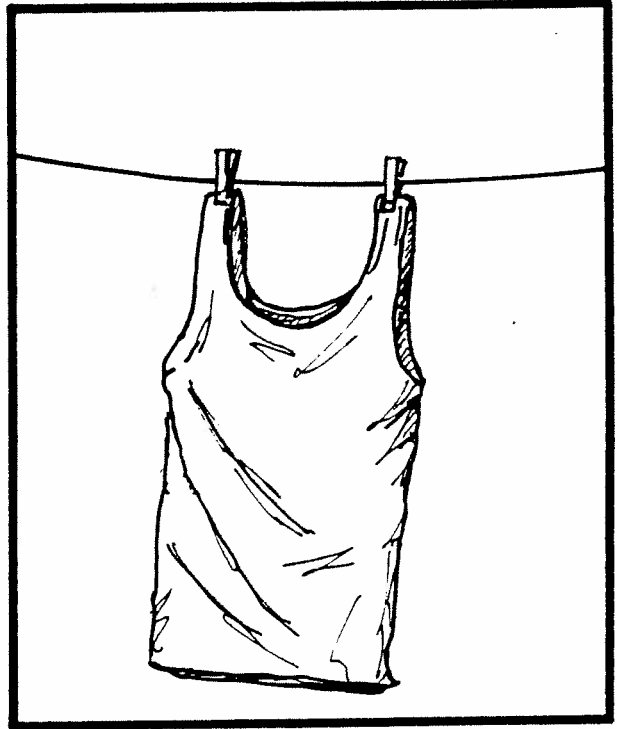

3

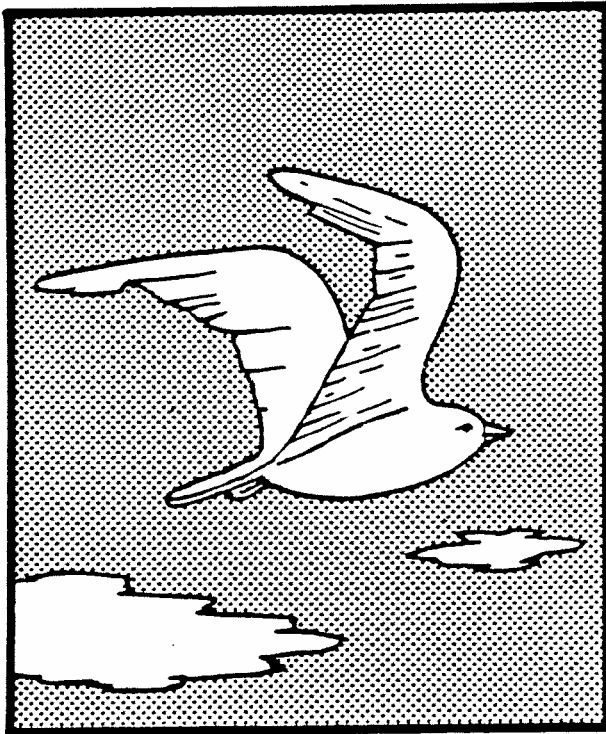

4

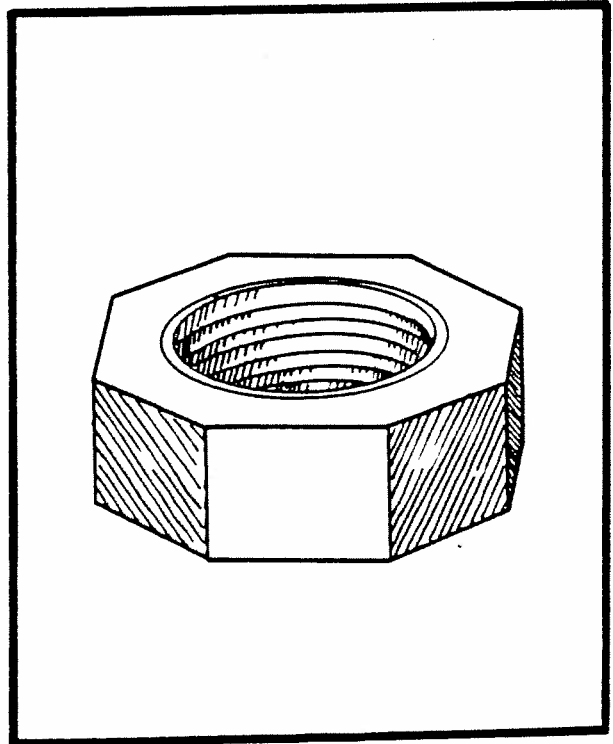

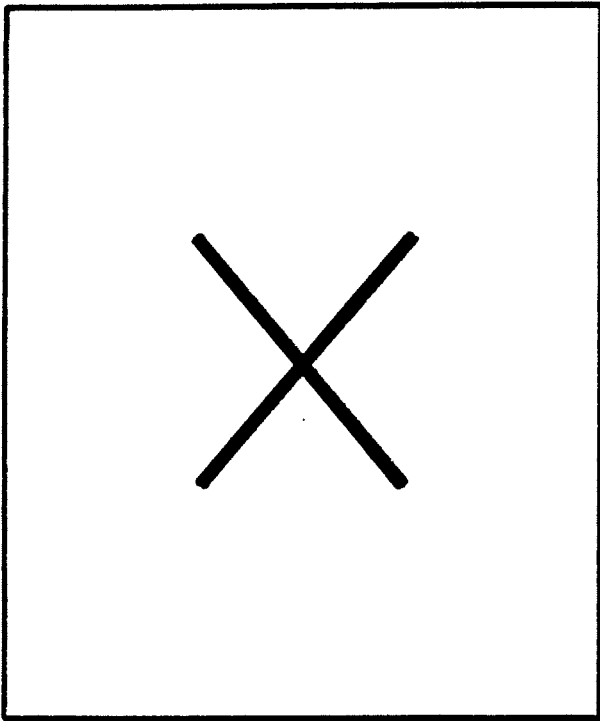

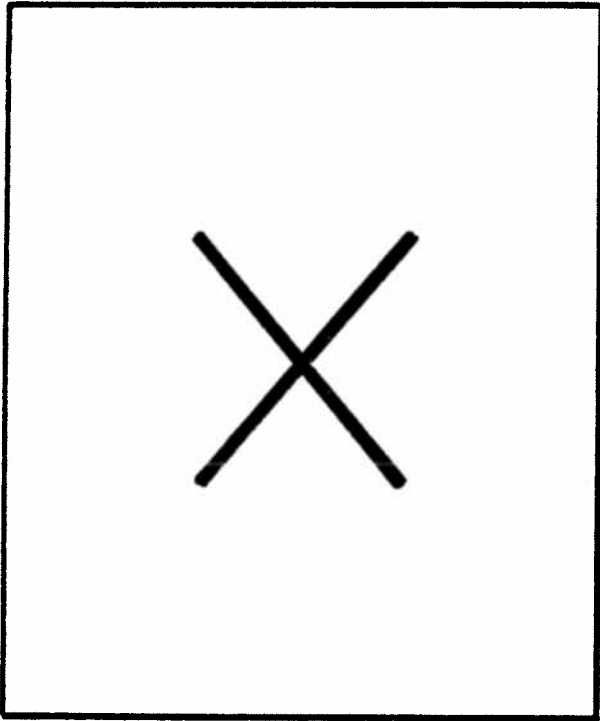

1

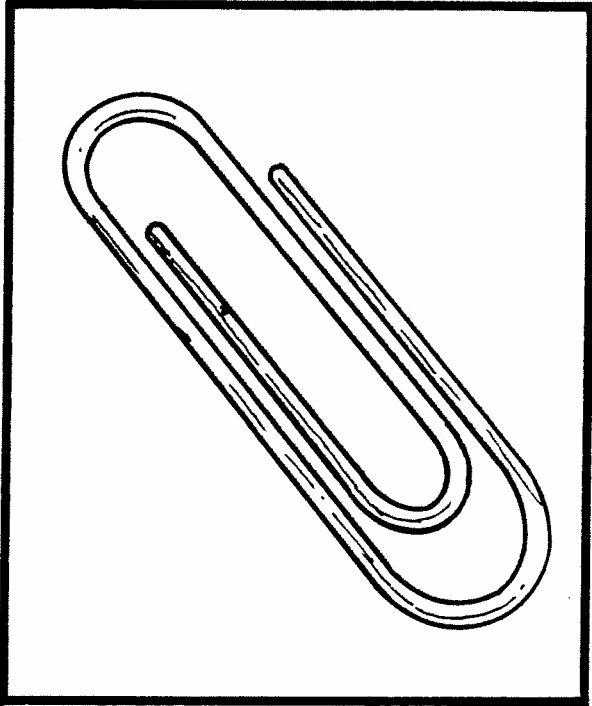

2

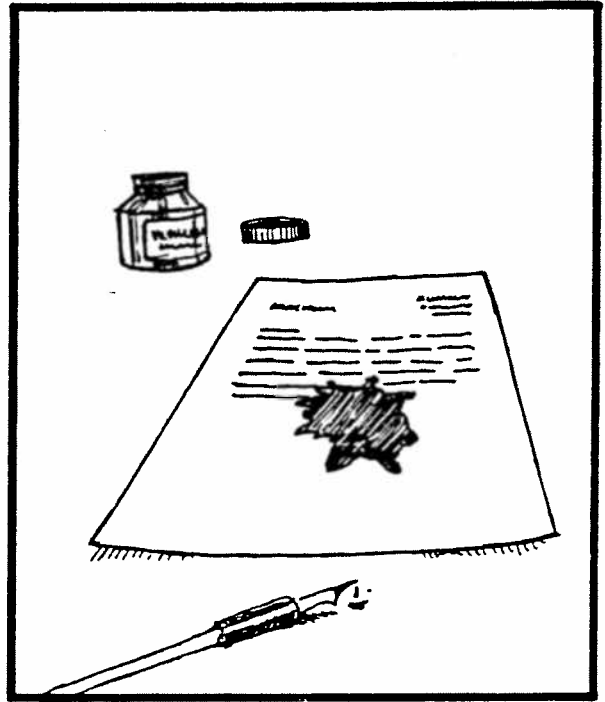

3

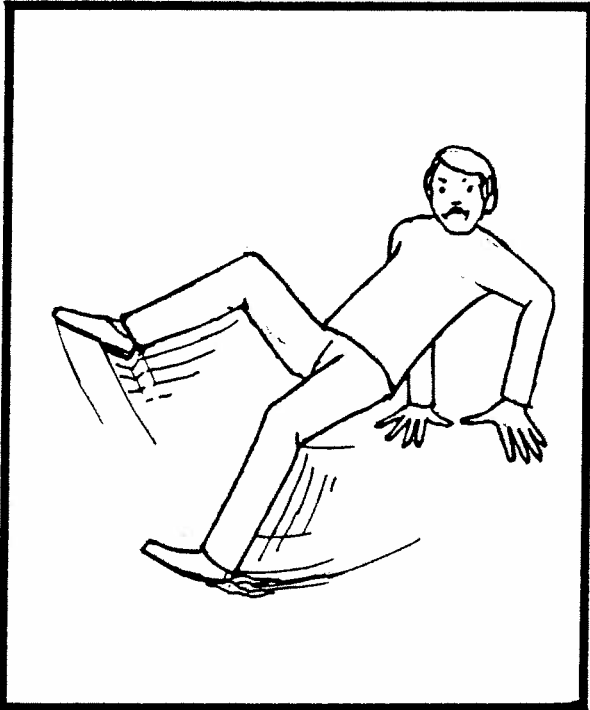

4

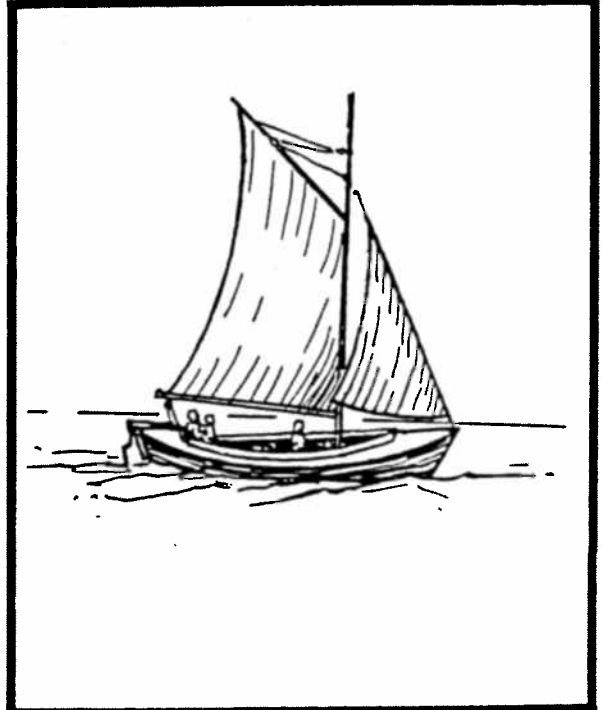

1

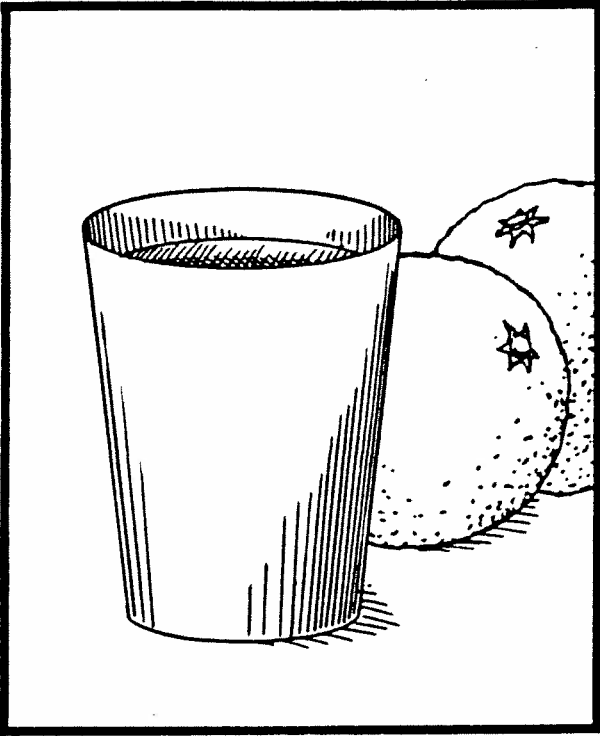

2

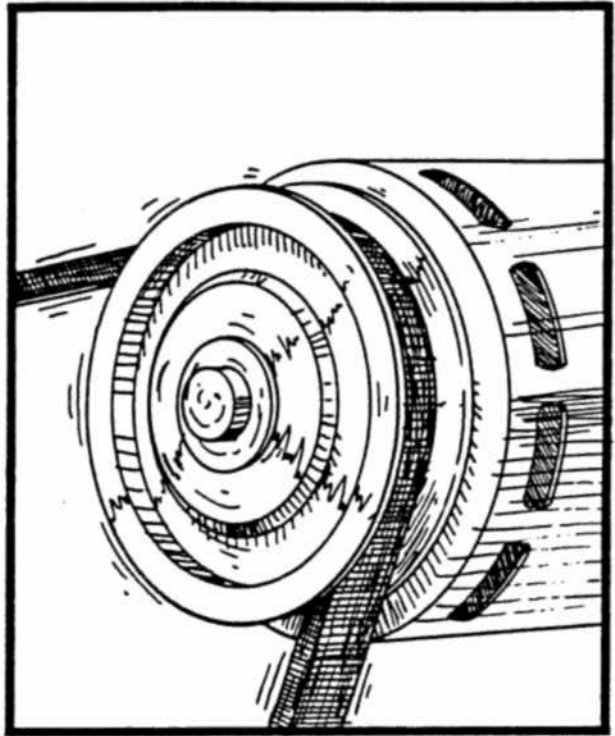

3

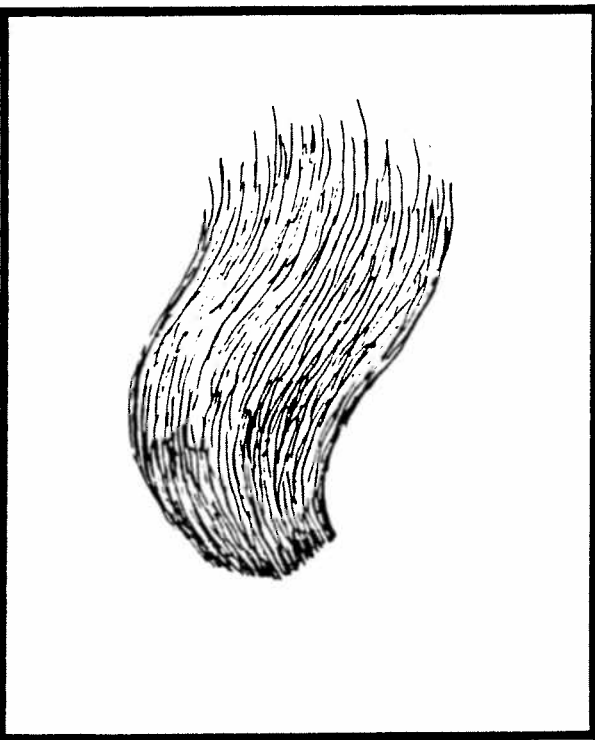

4

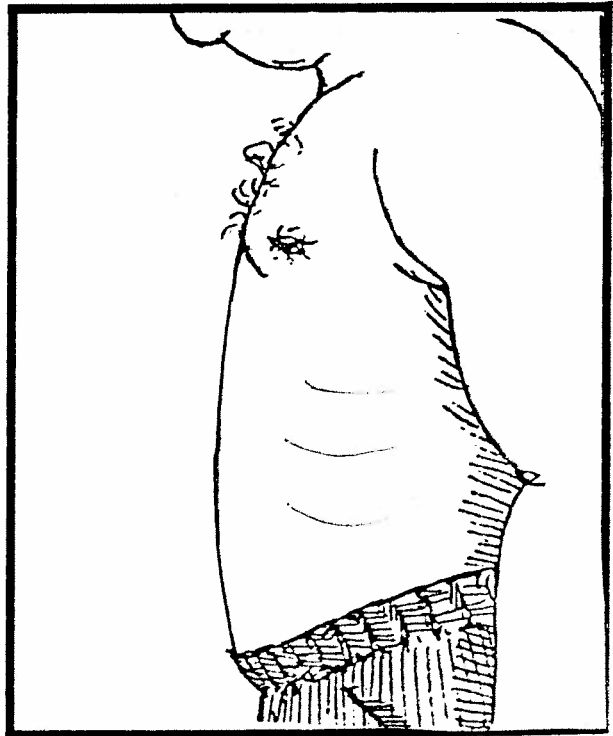

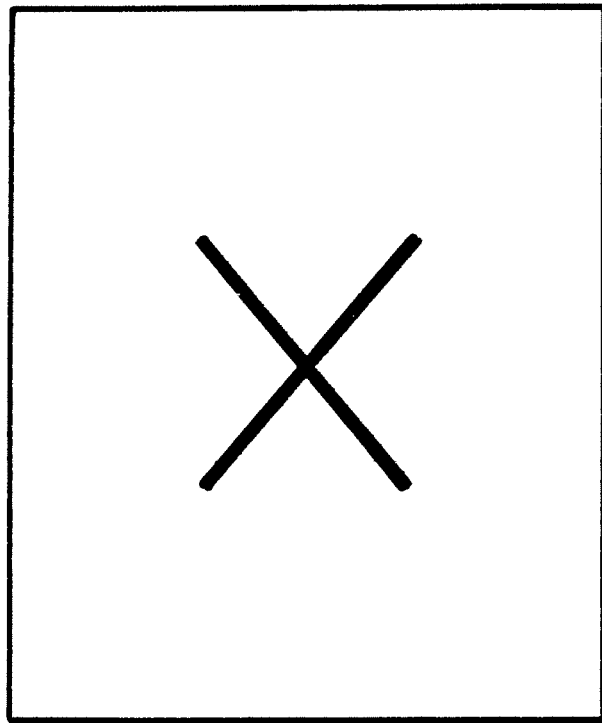

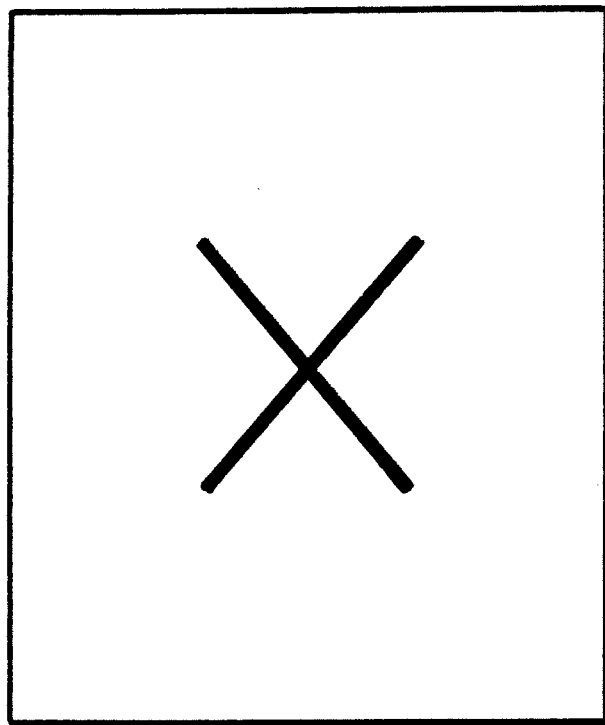

1



2

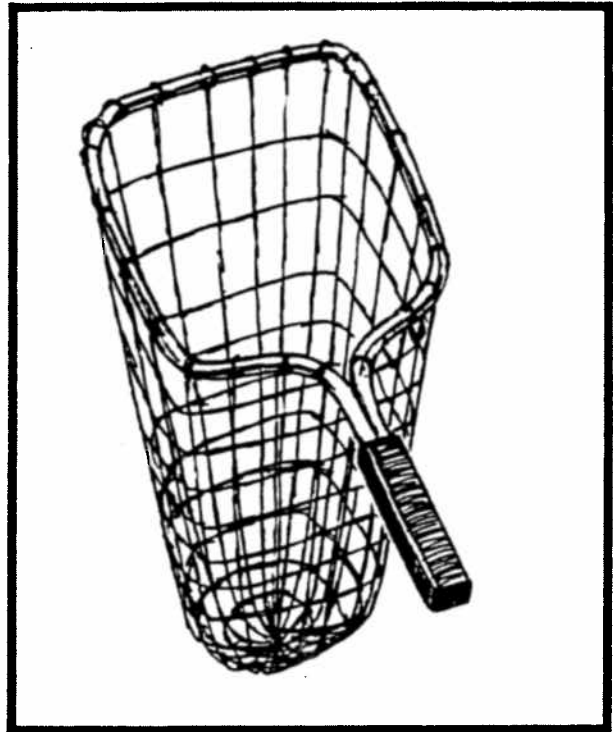

3

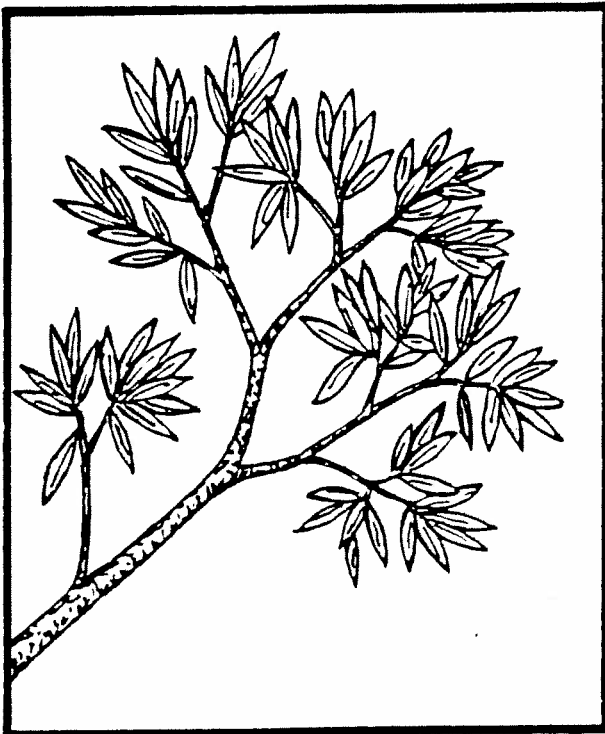

4

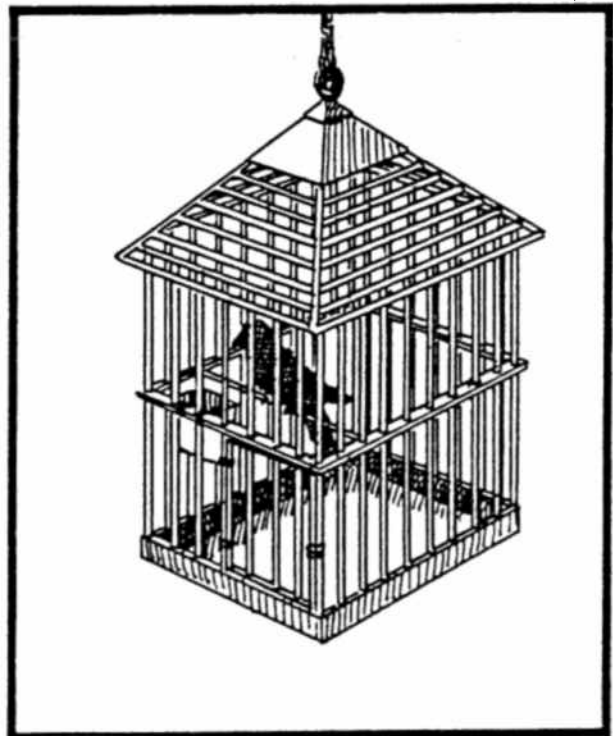

1

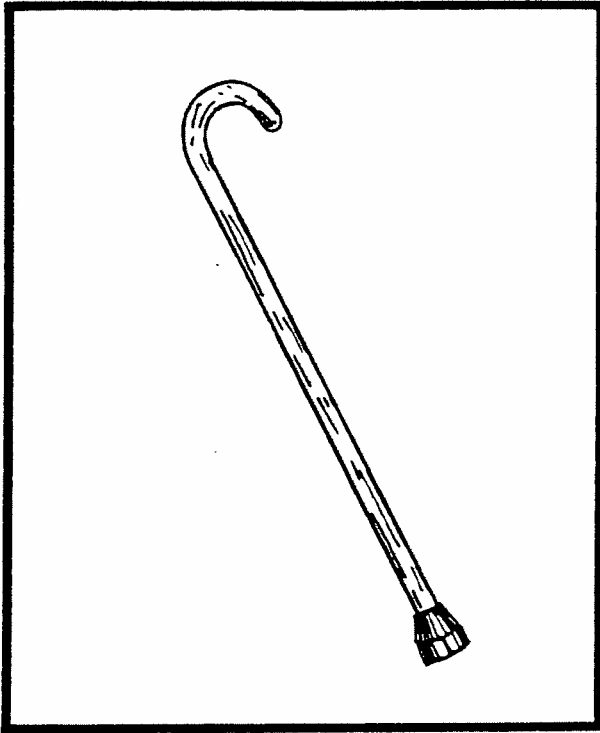

2



3

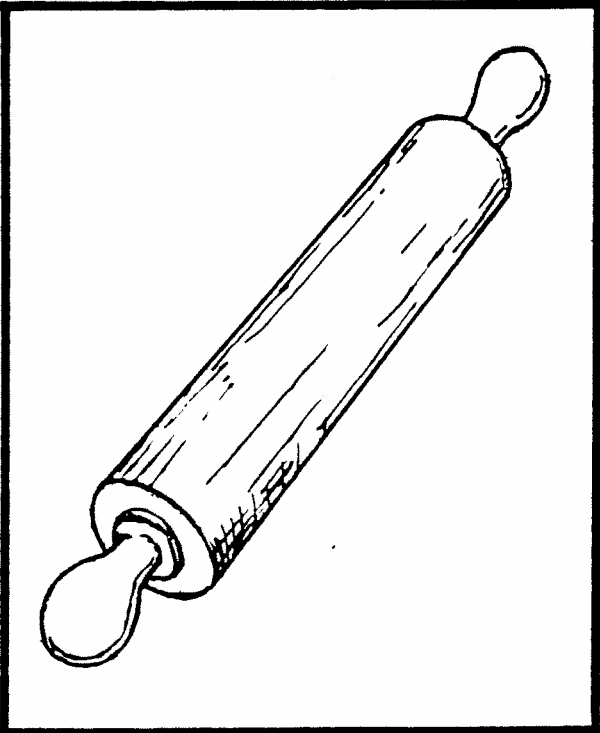

4

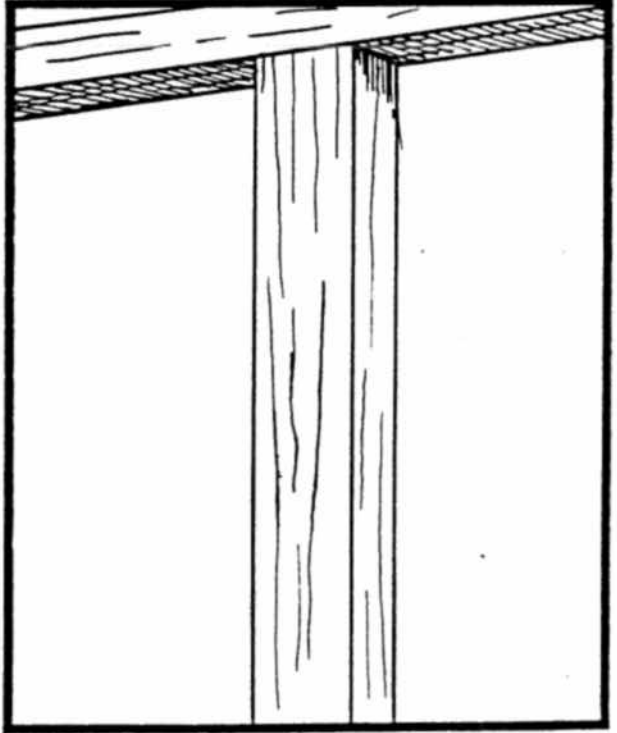

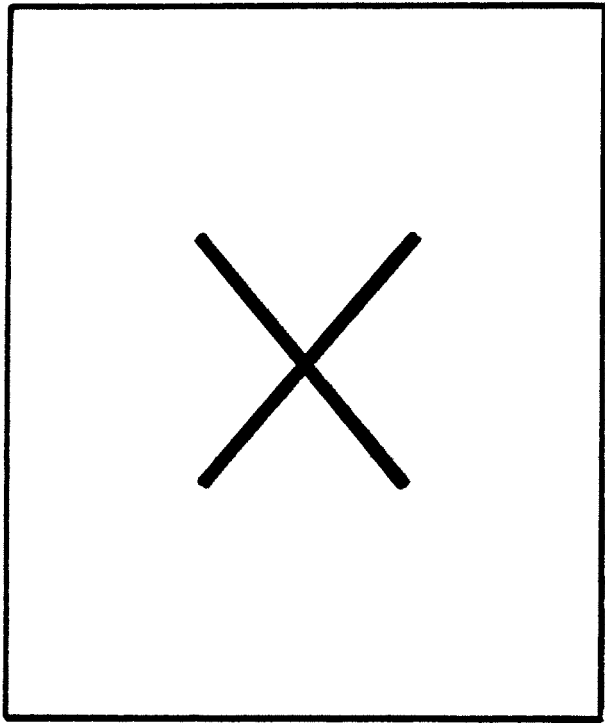

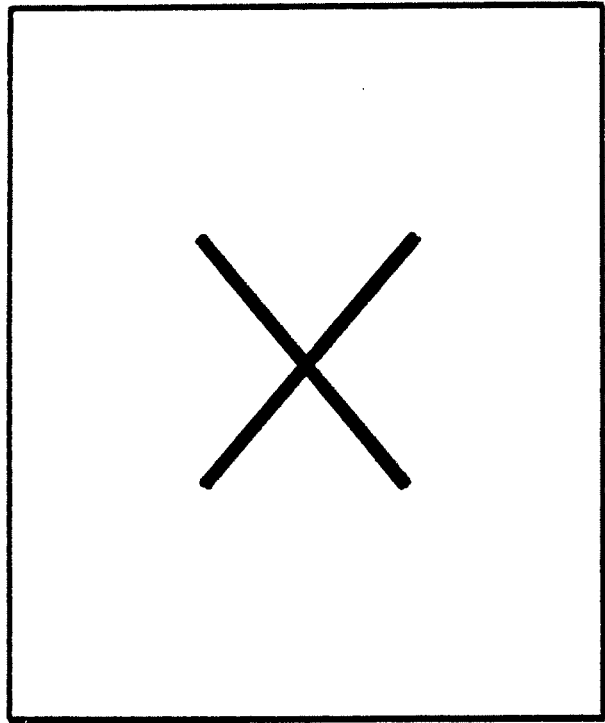

1

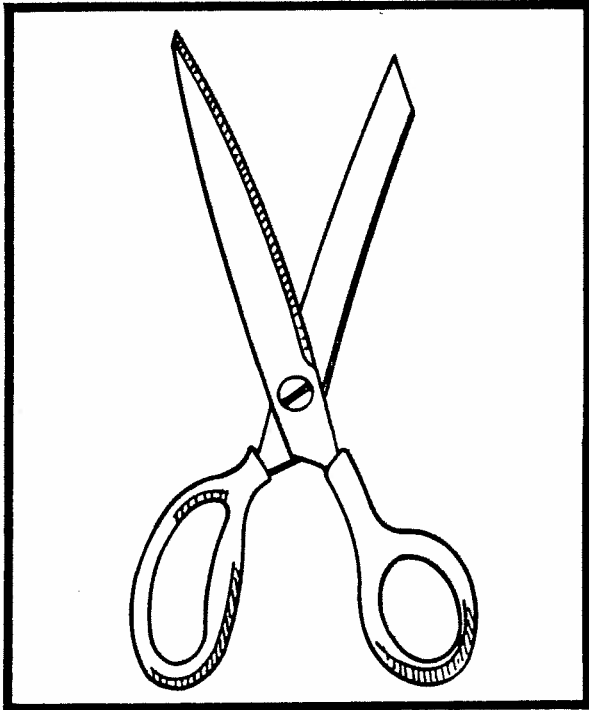

2

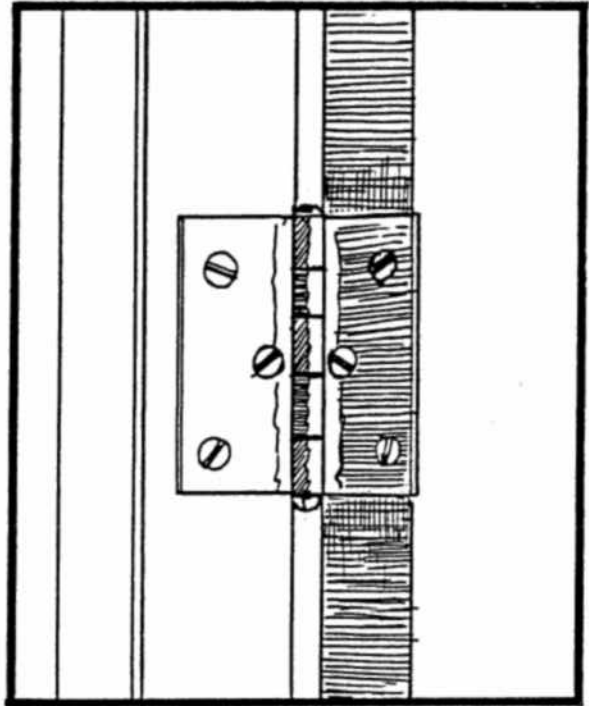

3

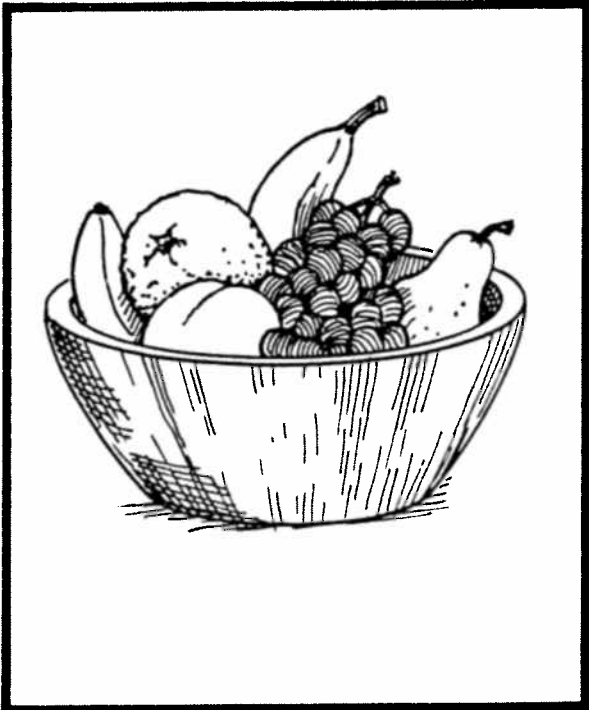

4

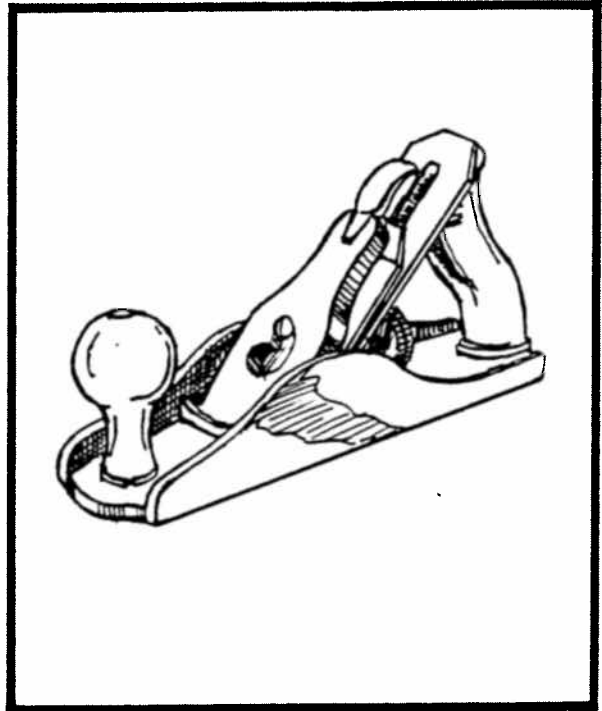

1

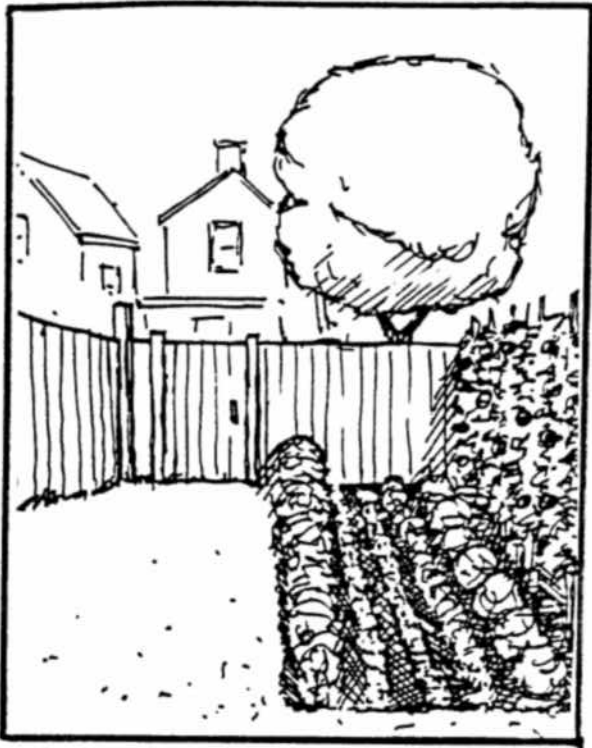

2

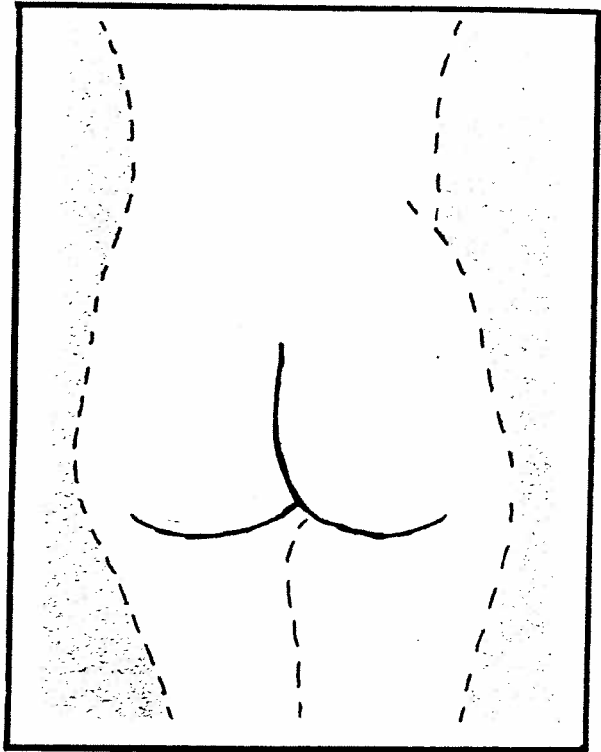

3

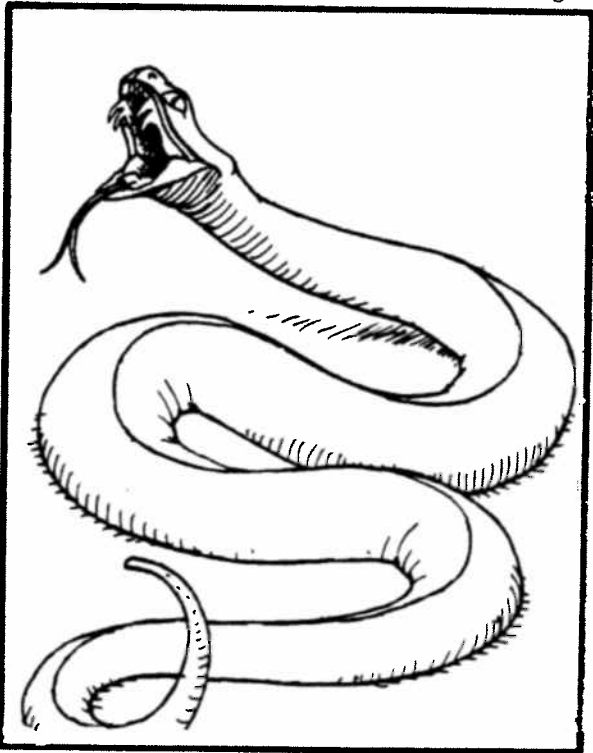

4

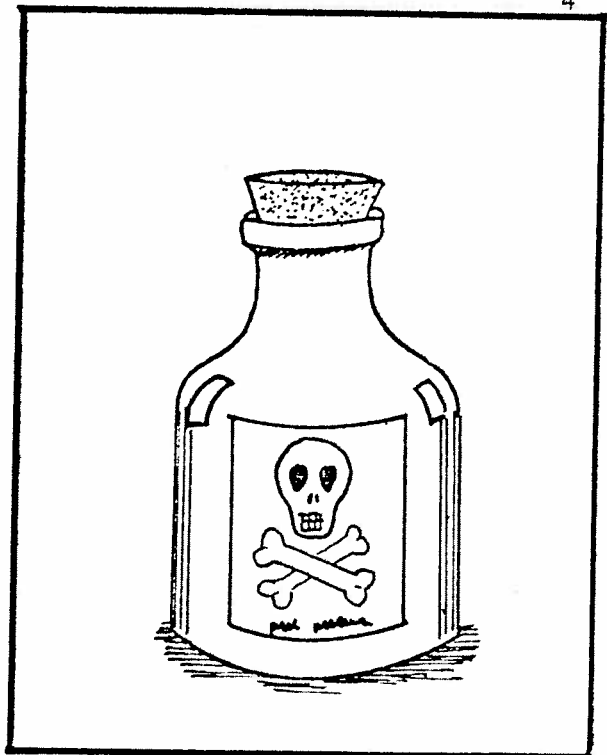

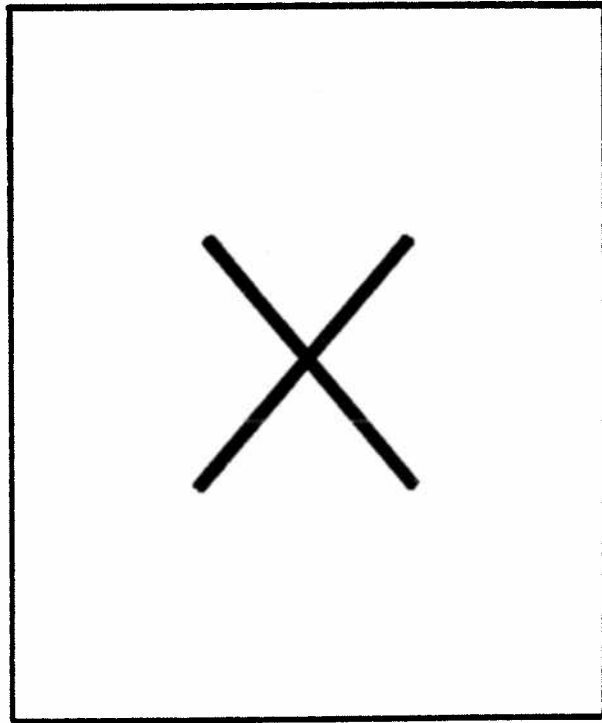

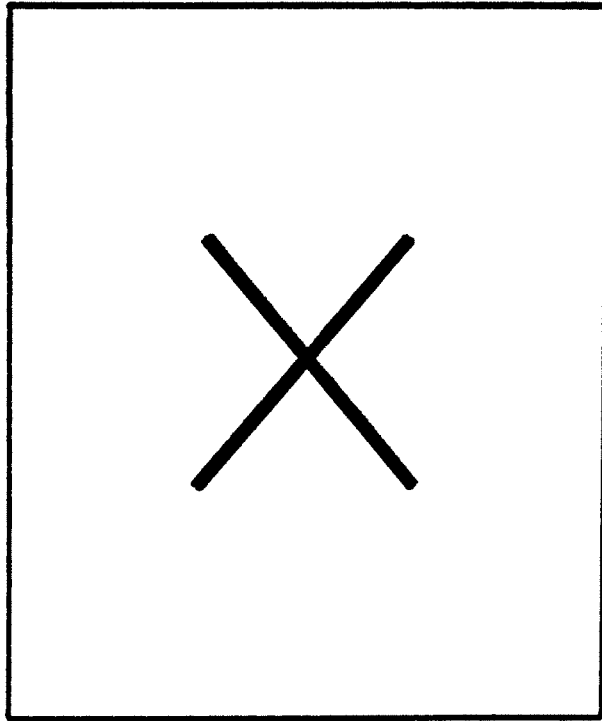

1

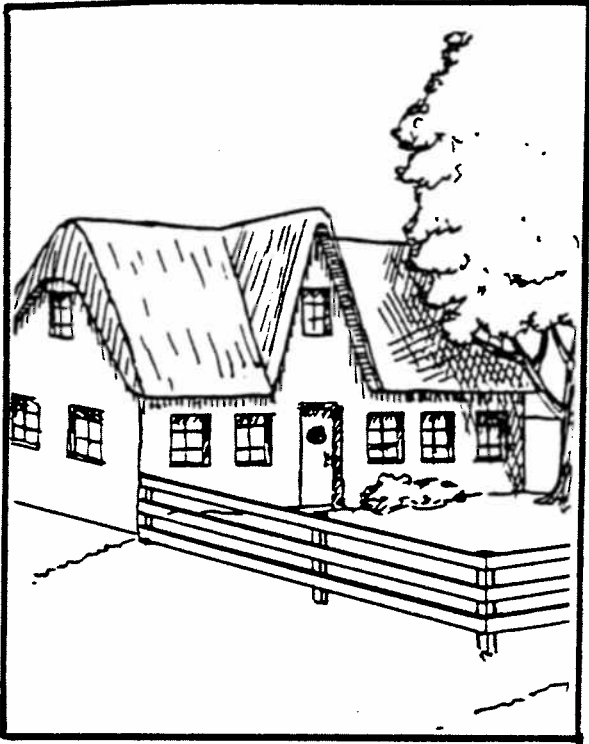

2

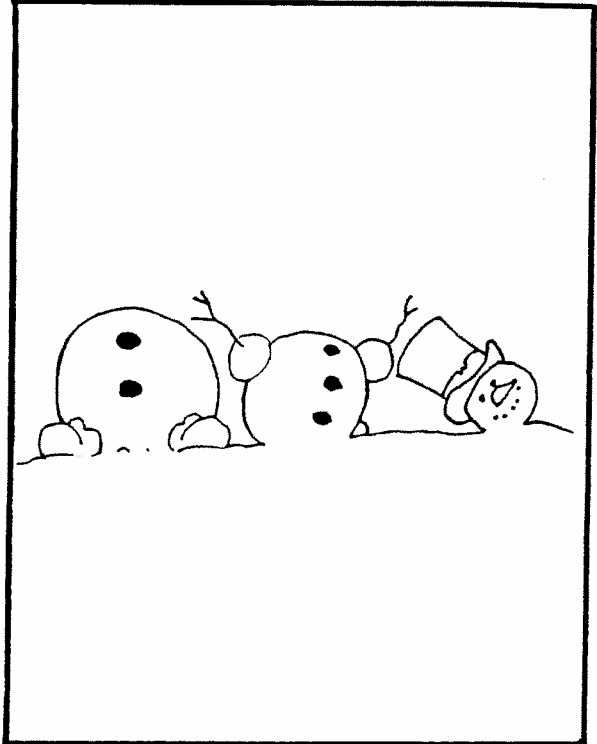

3

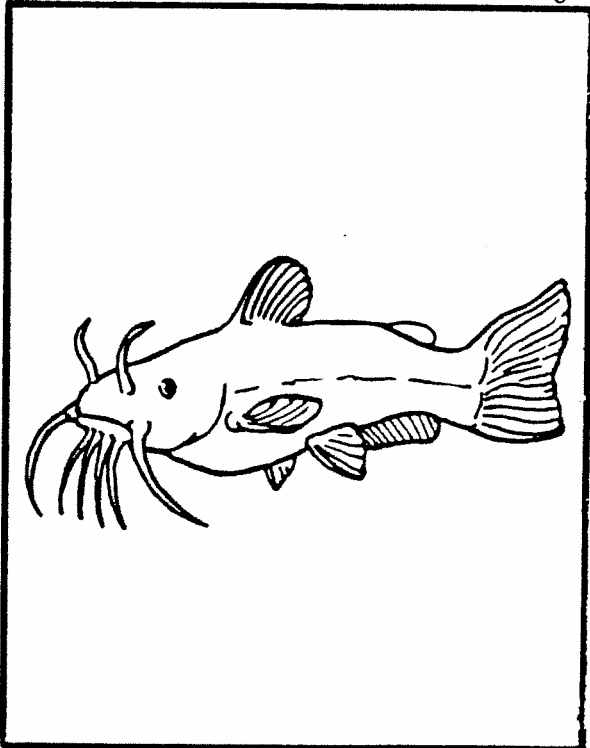

4



1

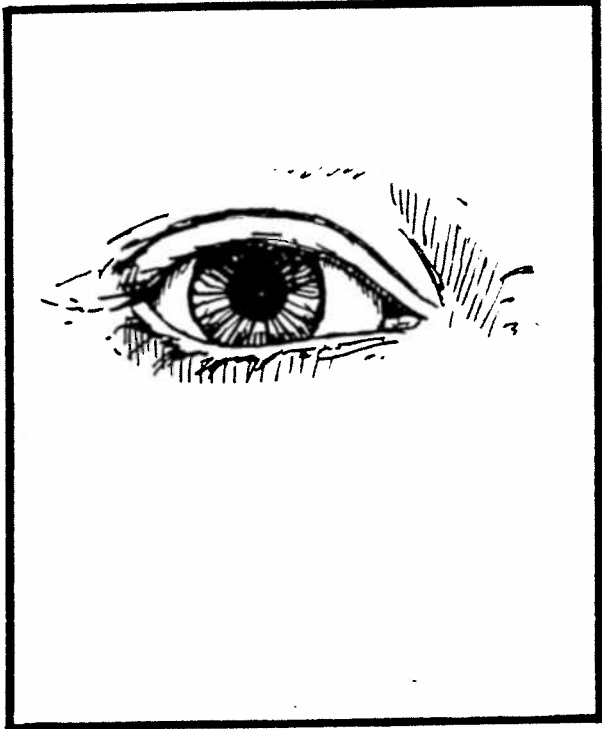

2

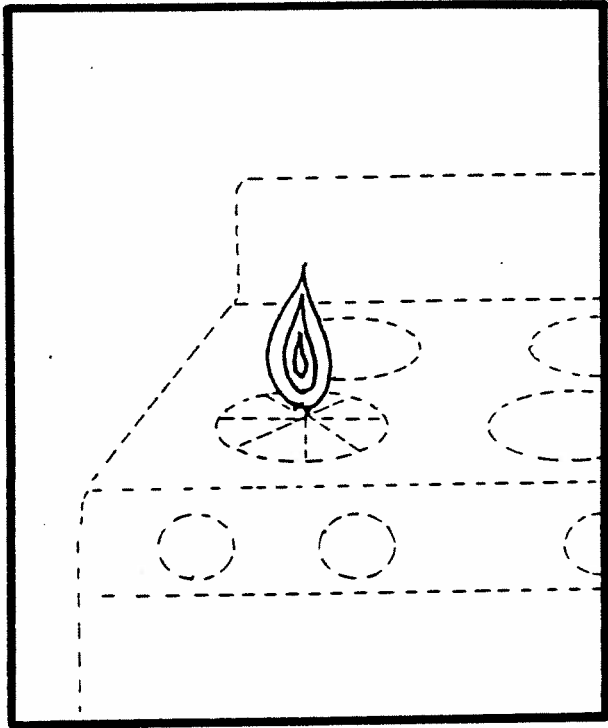

3



4

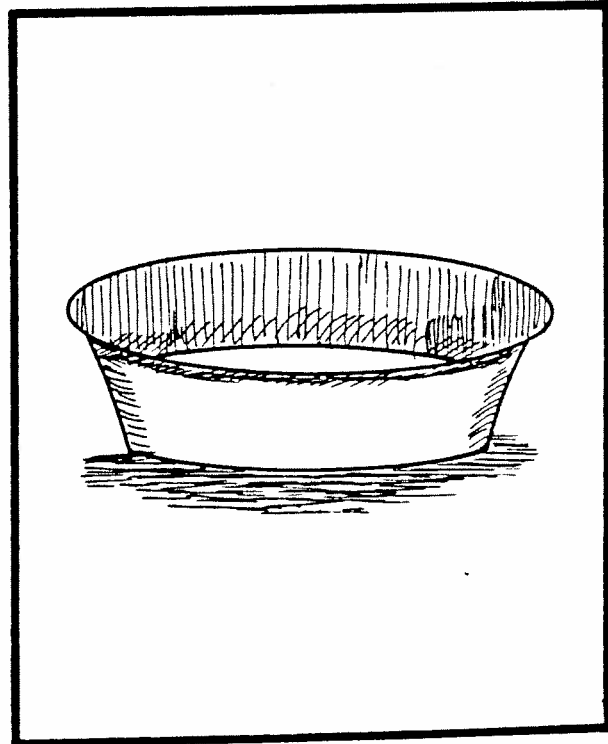

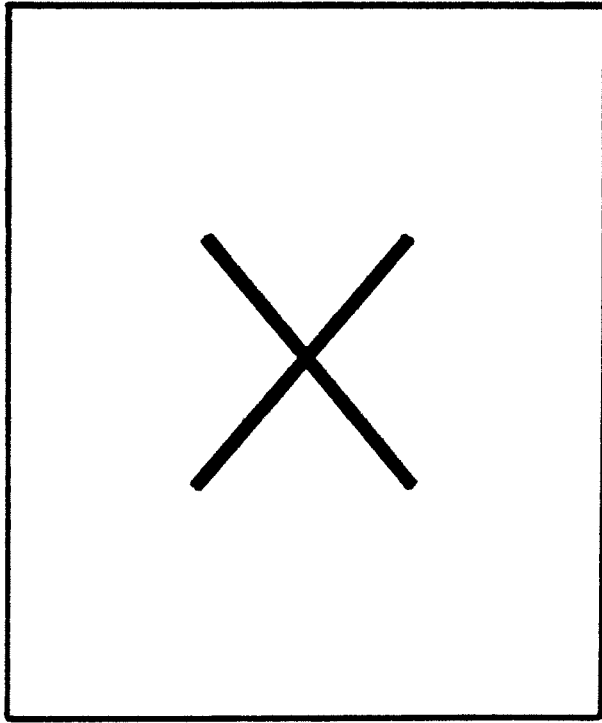

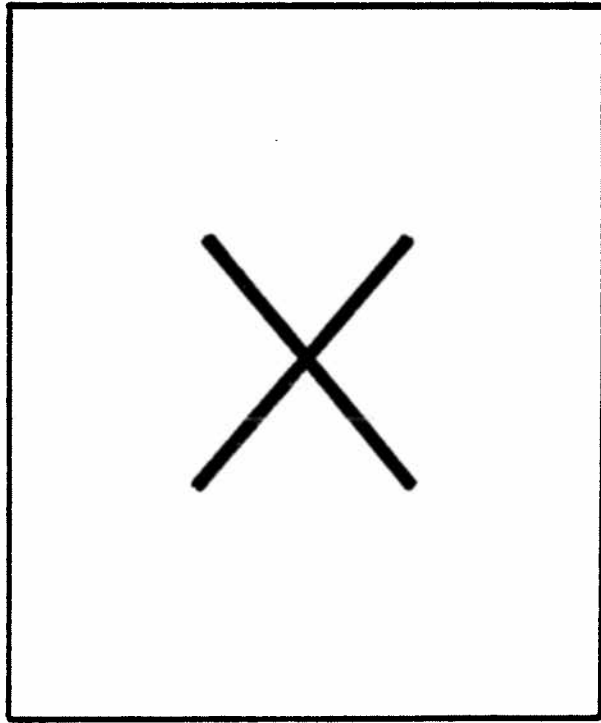

1

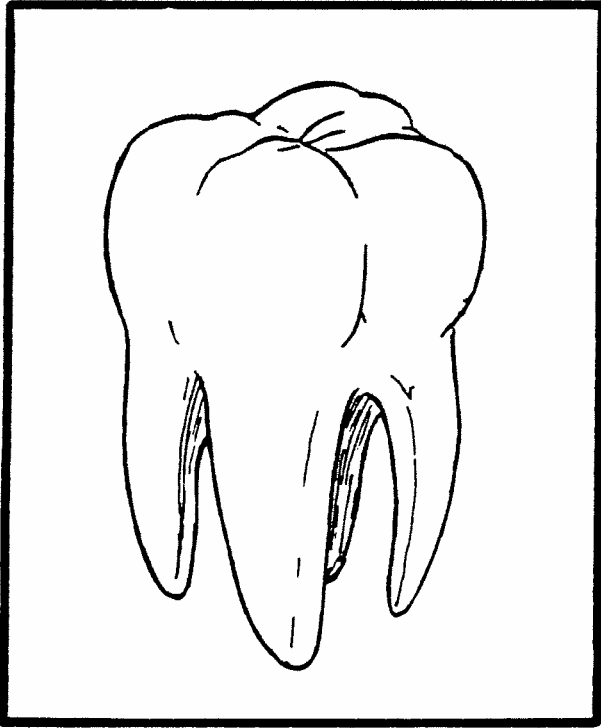

2

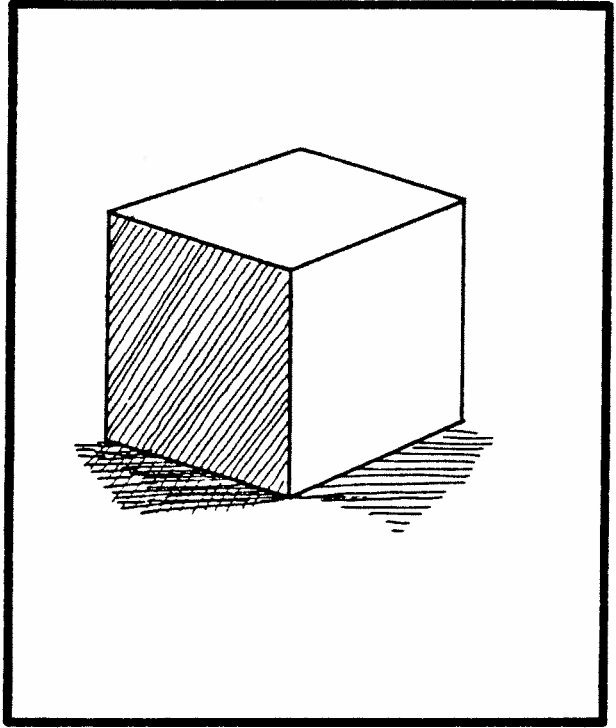

3

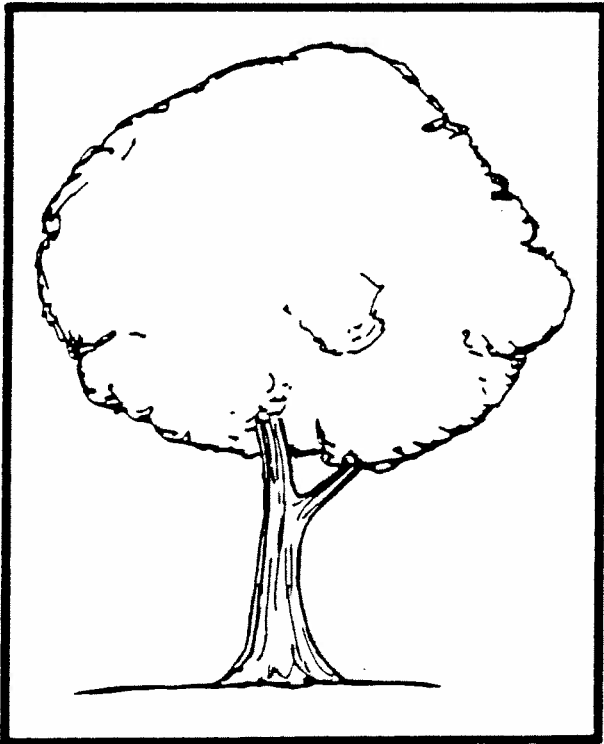

4



понимание синтаксических структур речи

1

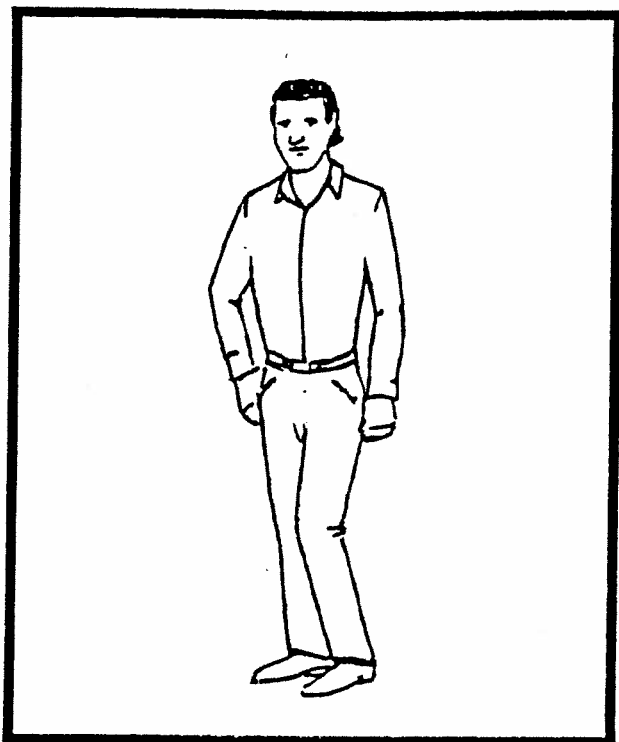

2

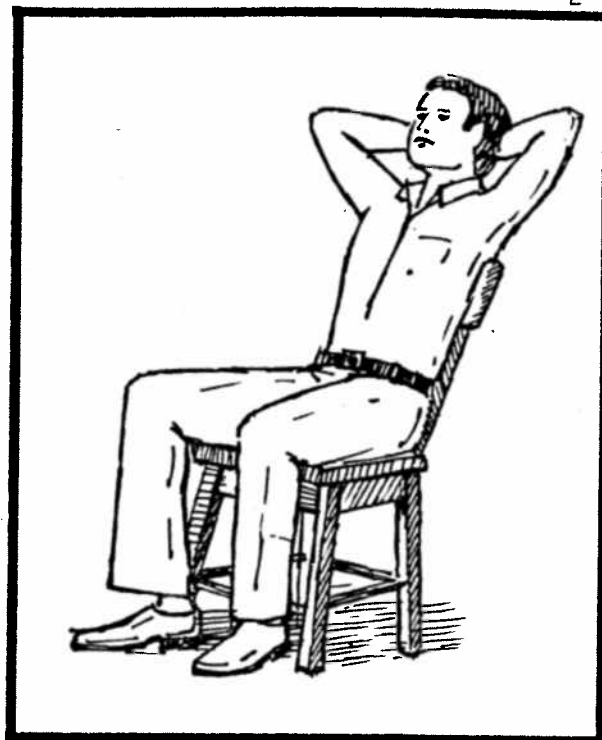

3

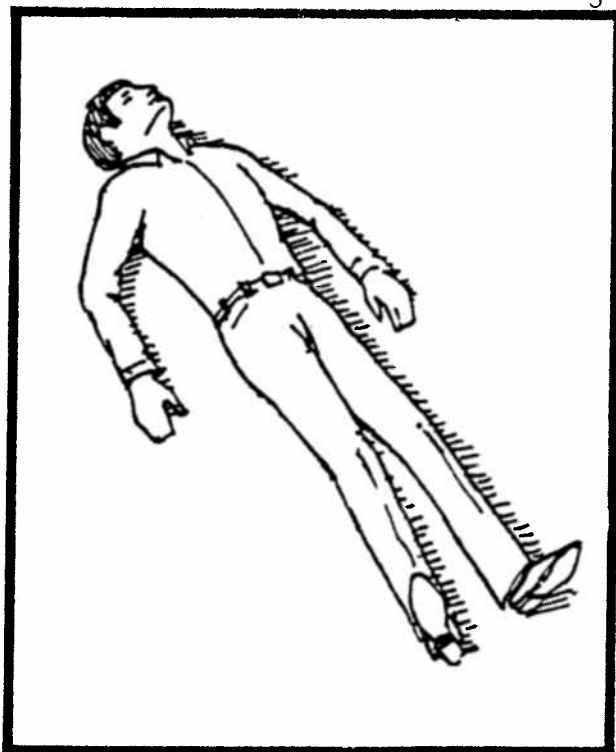

4



Образец

1

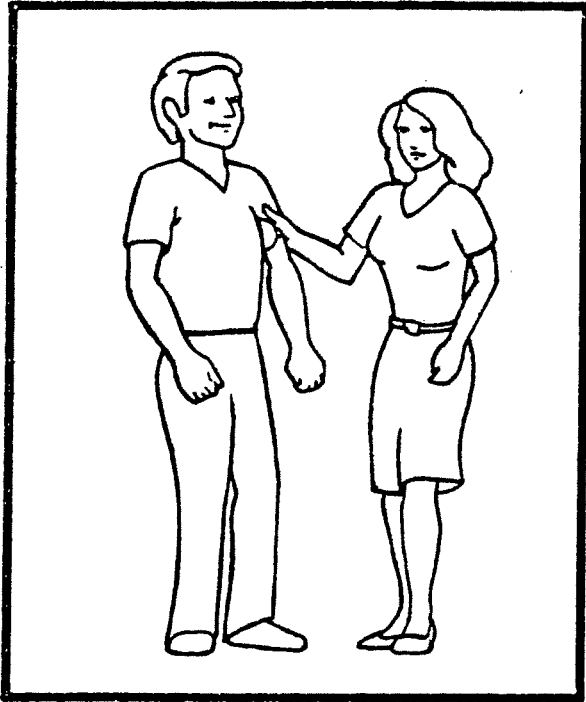

2

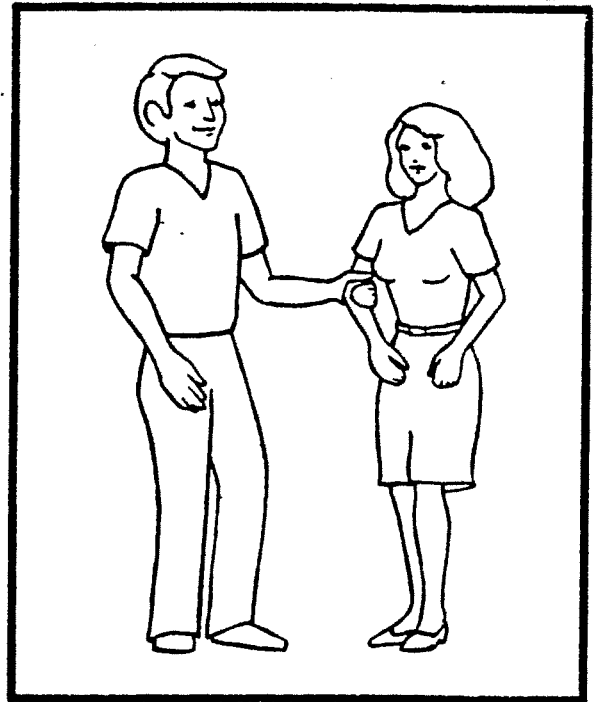

3

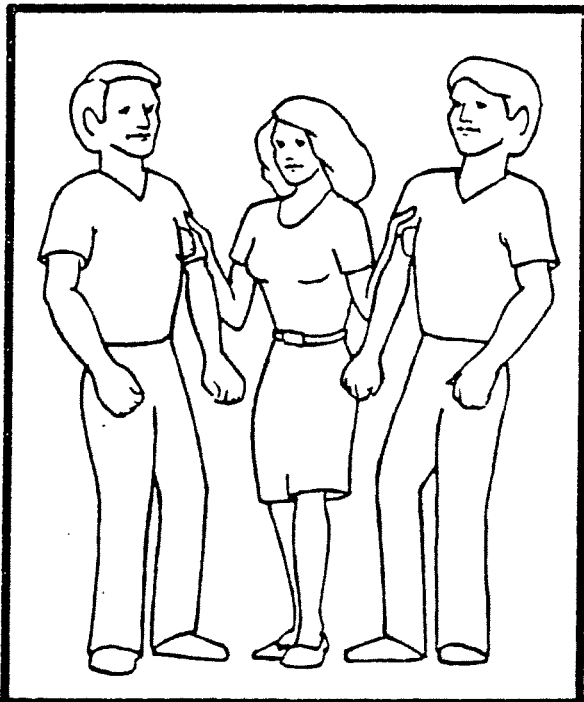

4

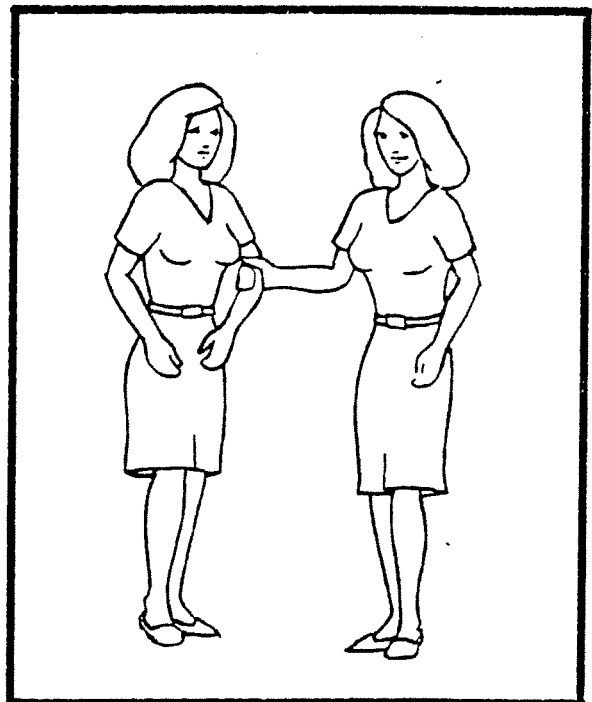

1

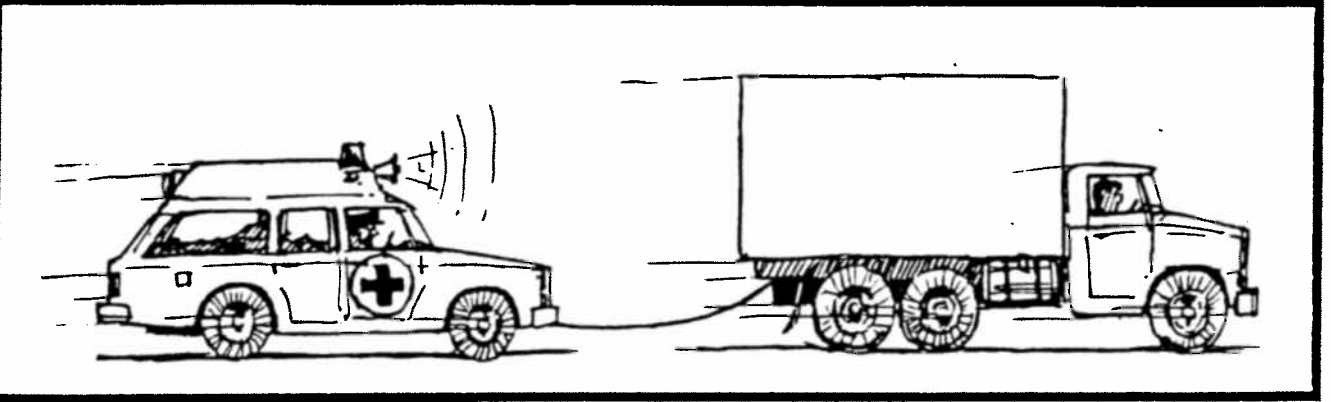
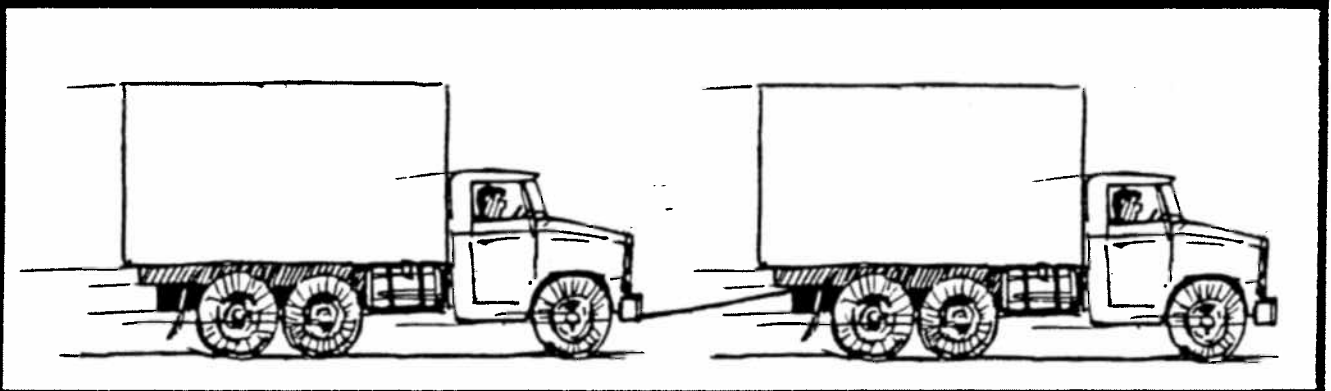
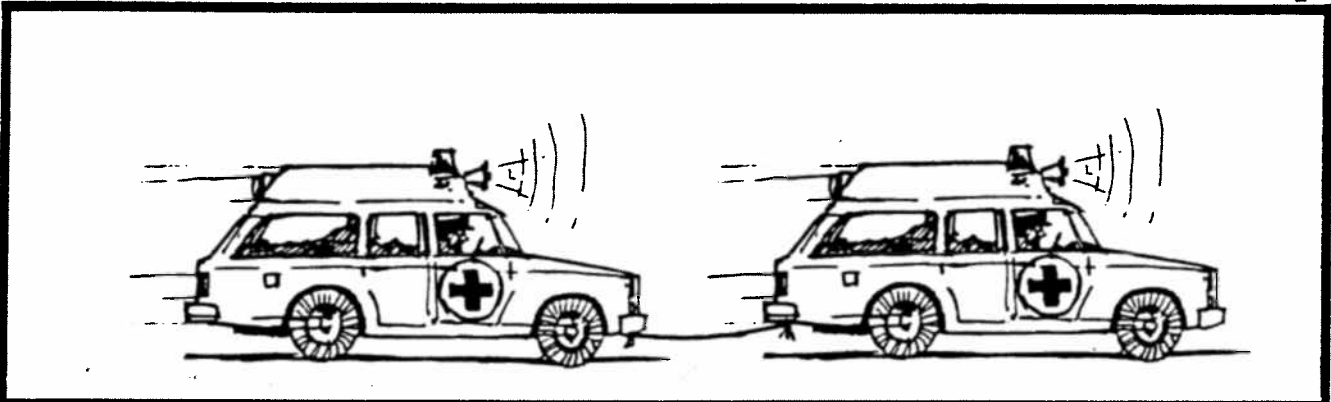
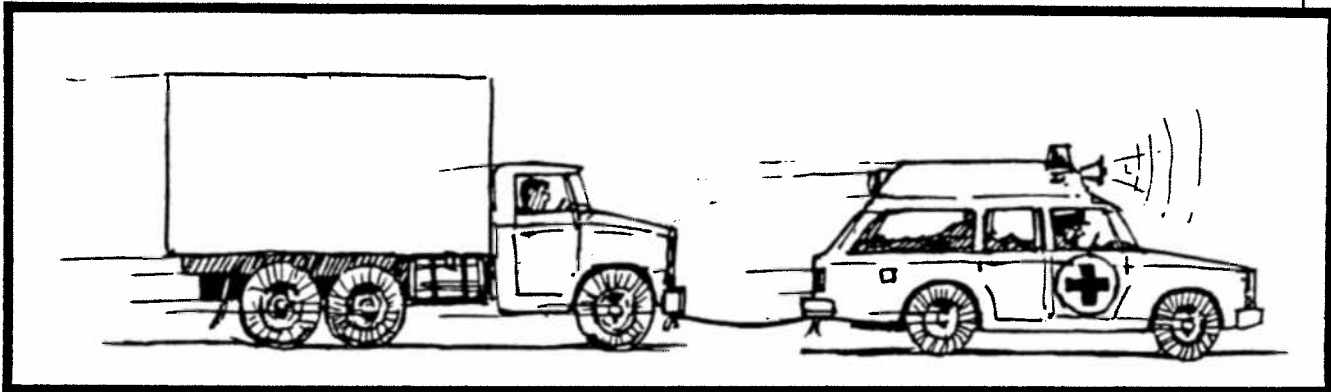

1

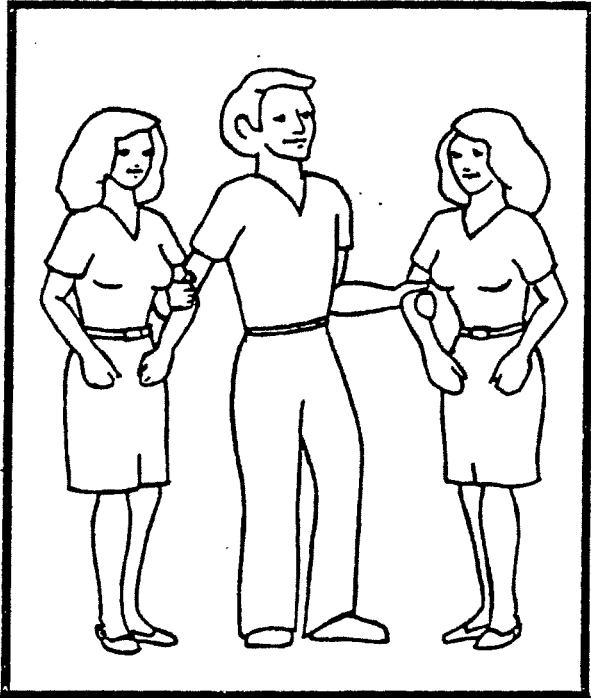

2

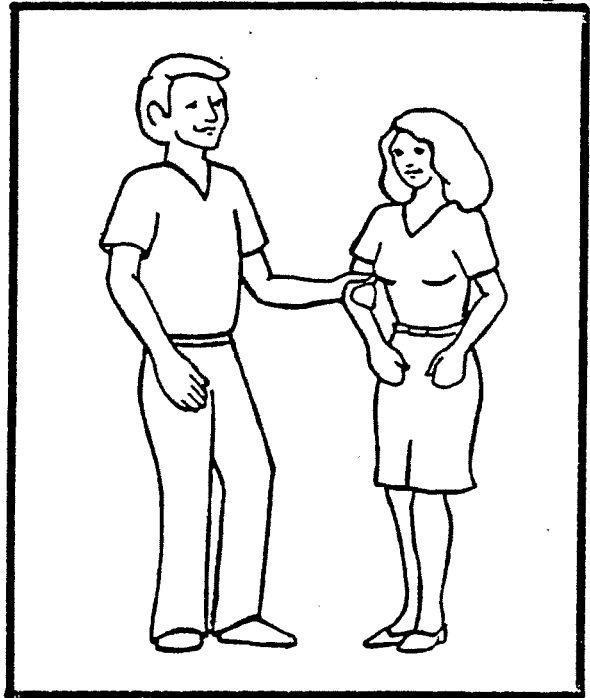

3

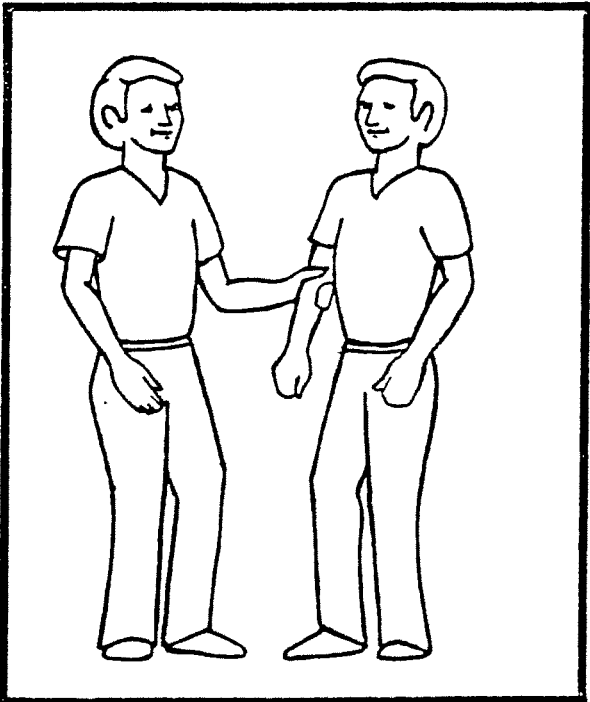

4

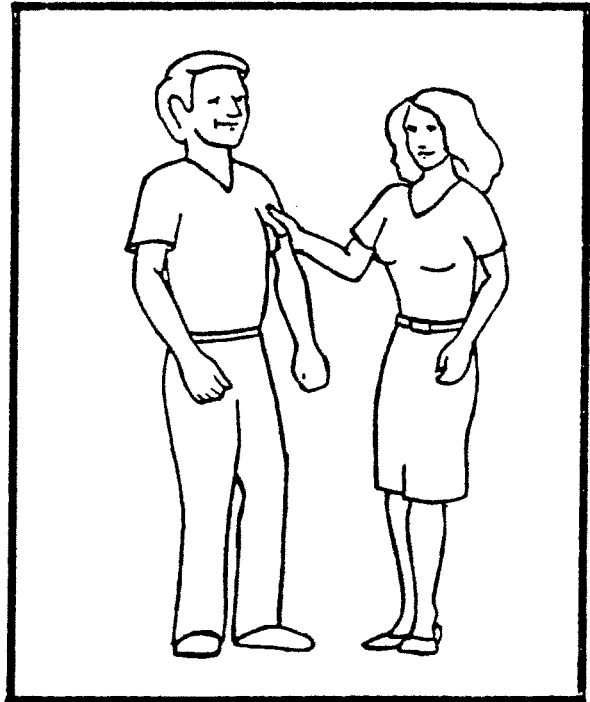

3

1

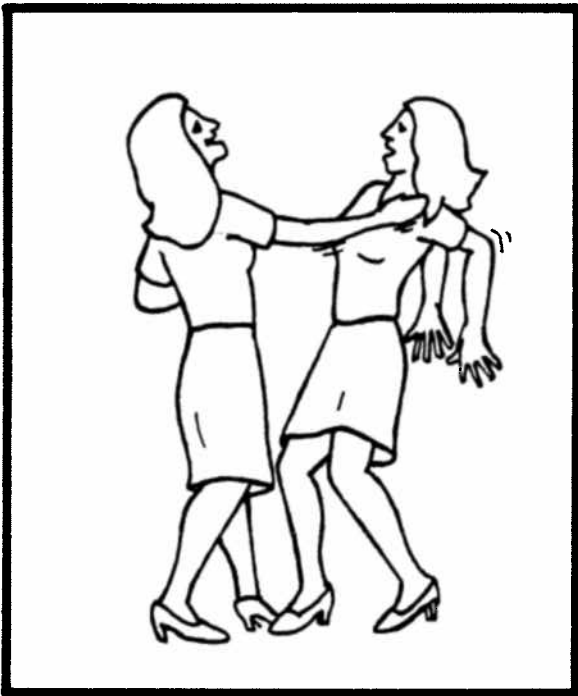

2

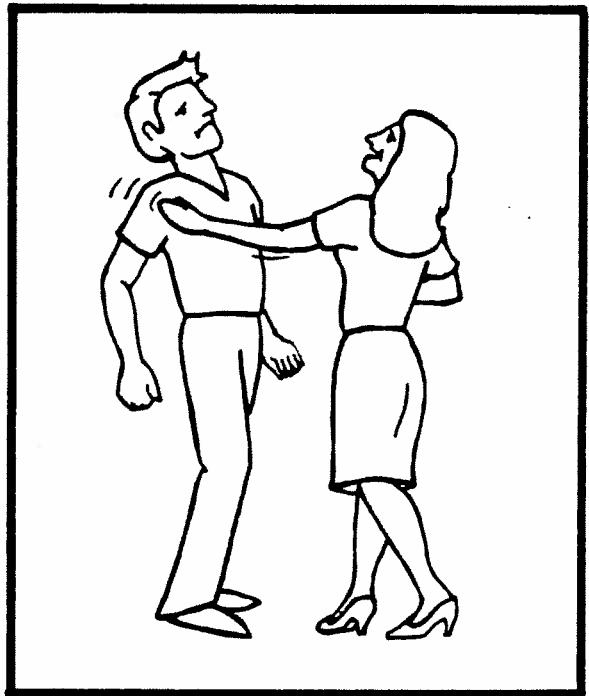

3

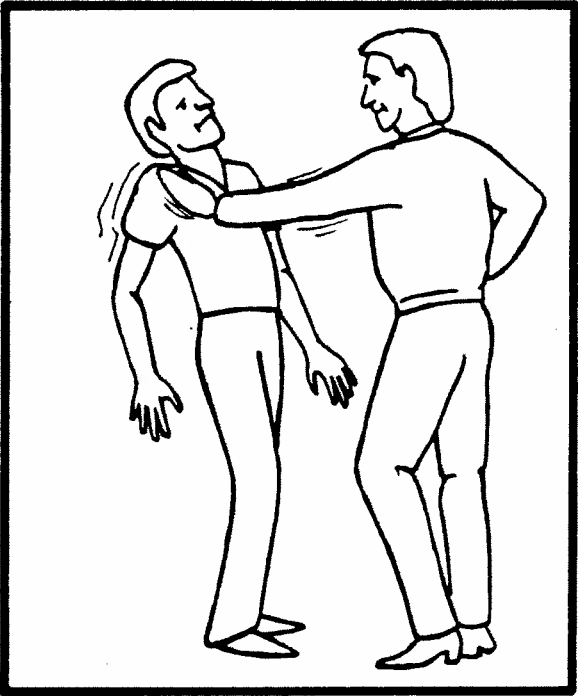

4

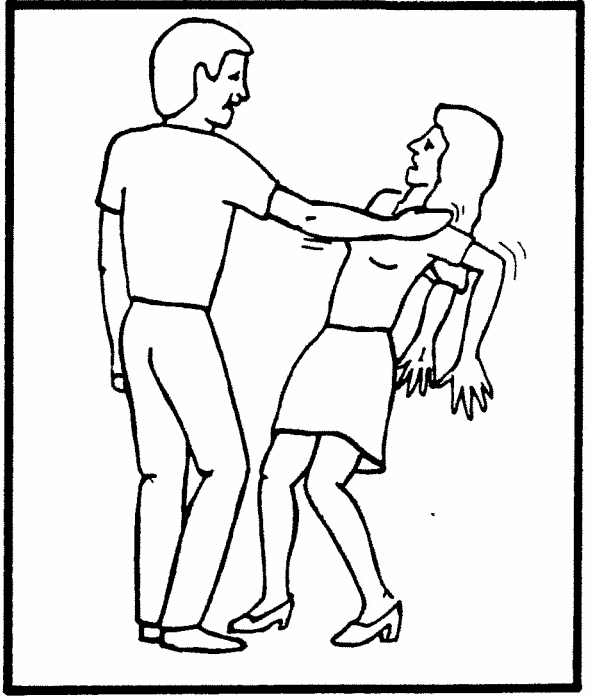

4

1

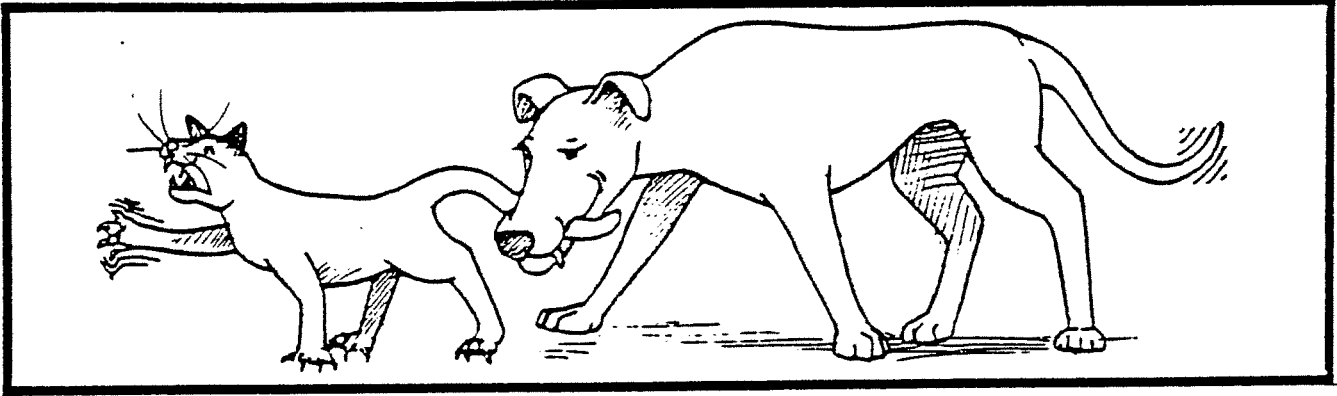

2

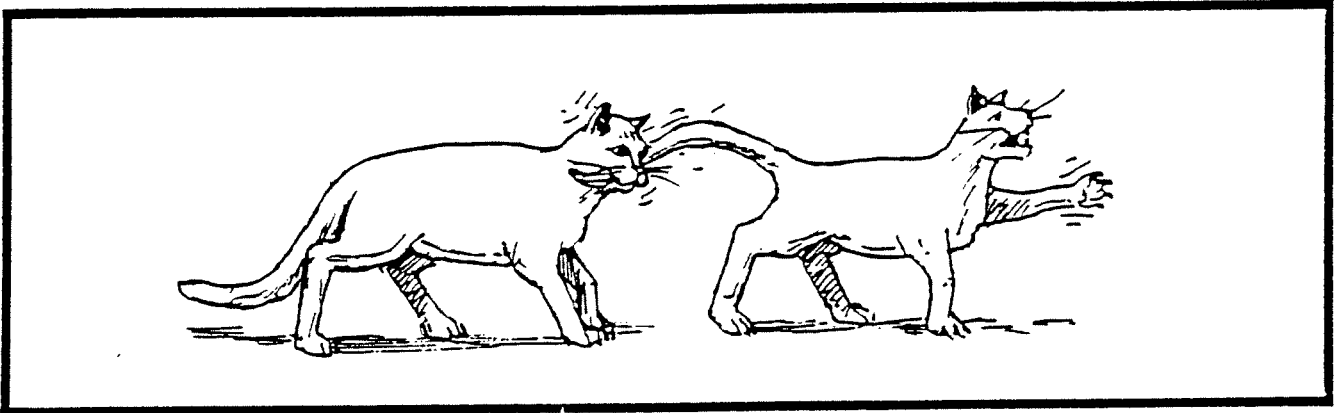

3

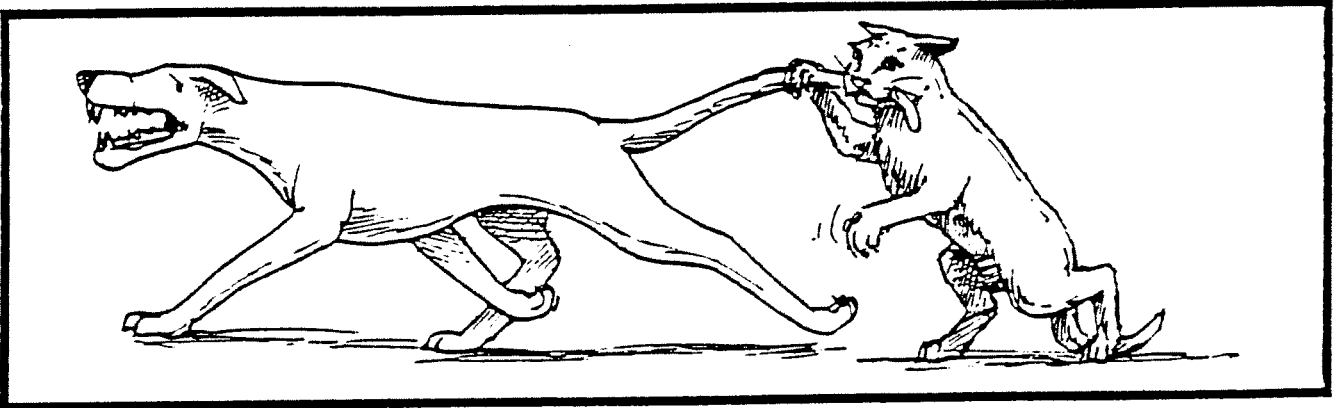

4

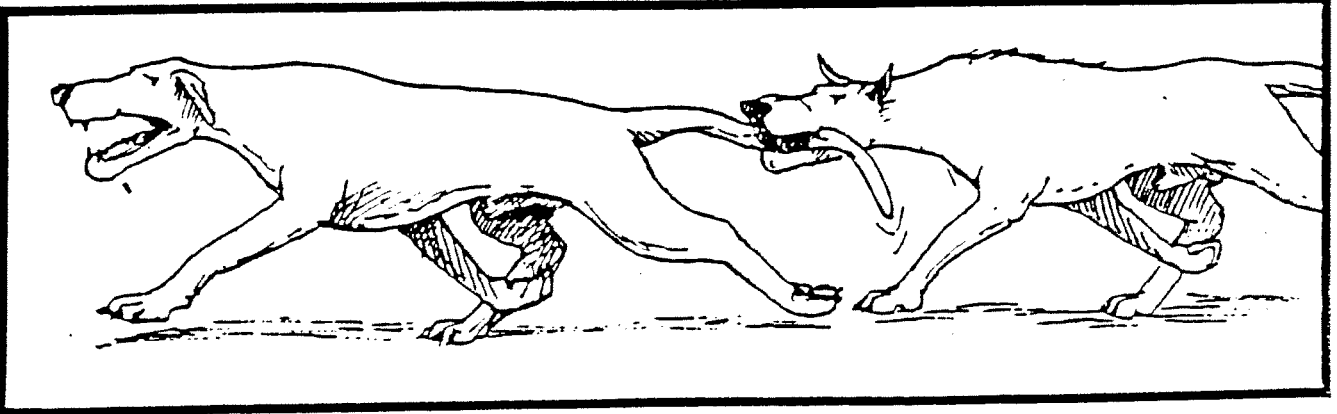

1

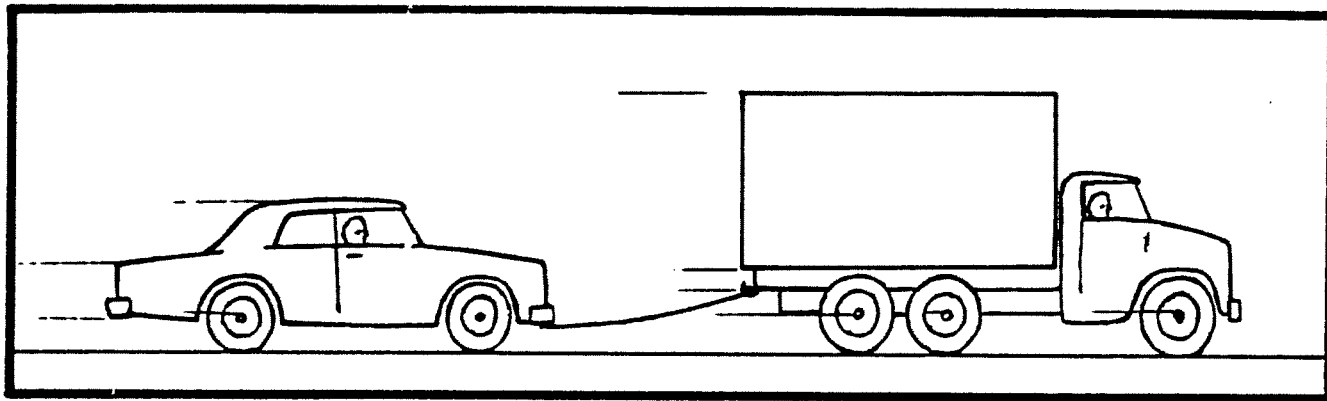

2

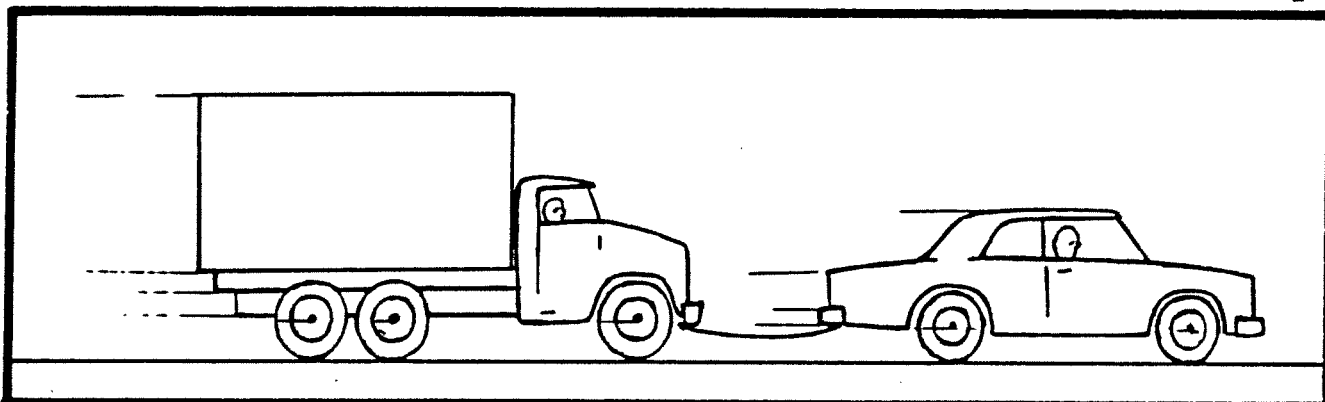

3

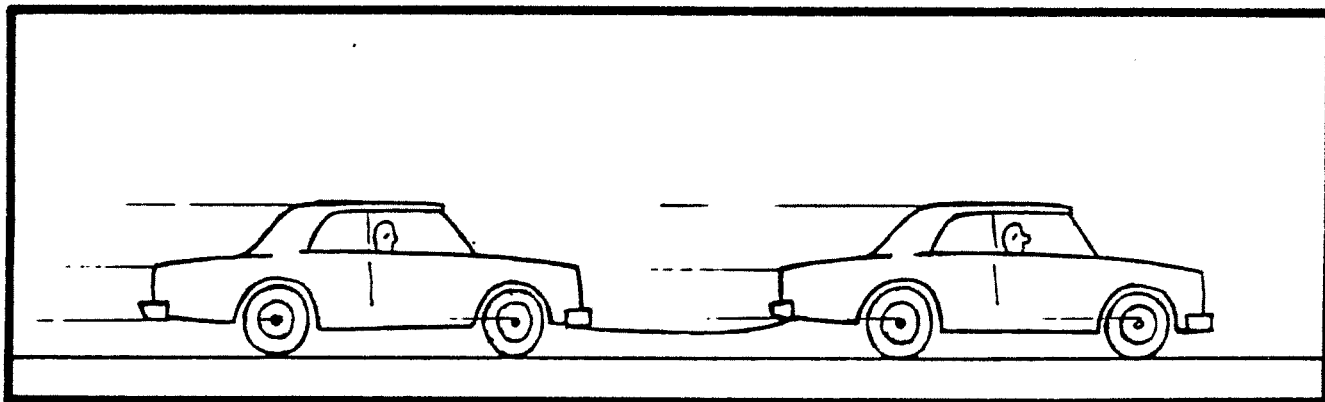

4

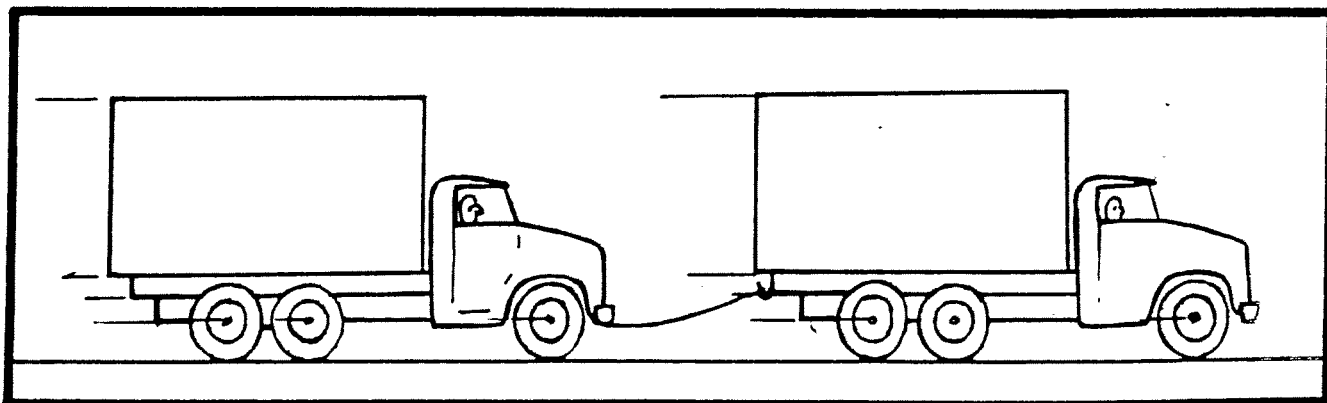

6

1

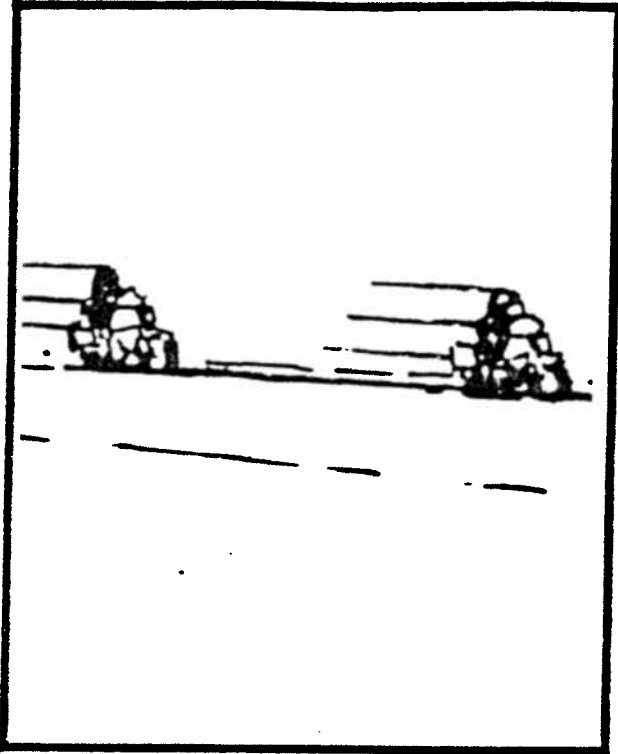

2

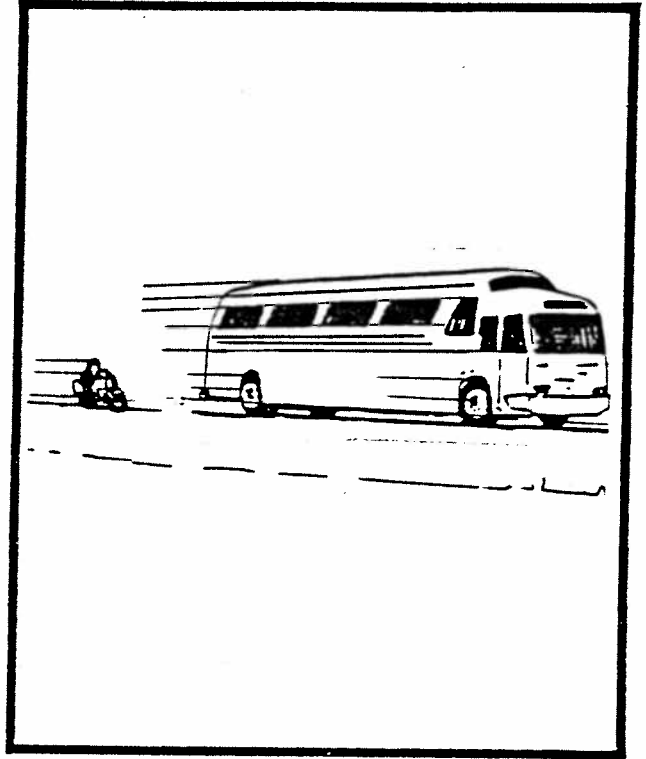

3

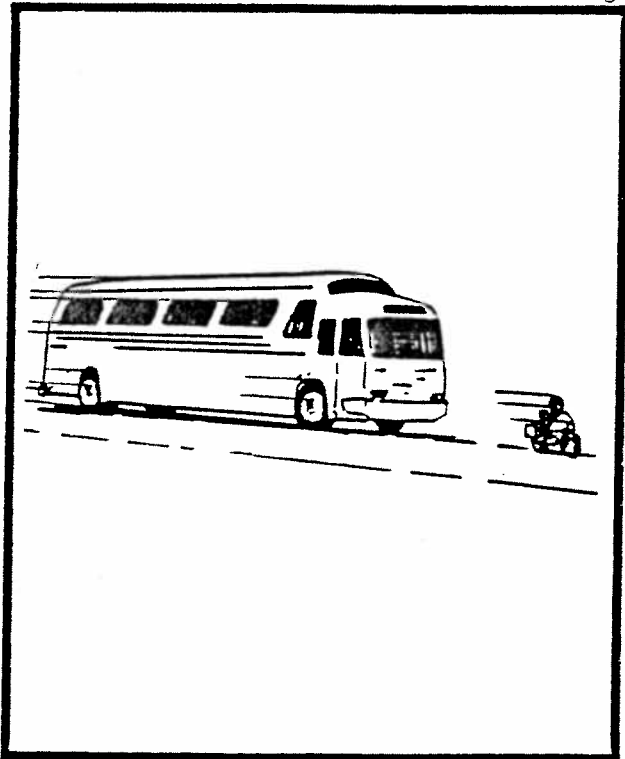

4



7

1

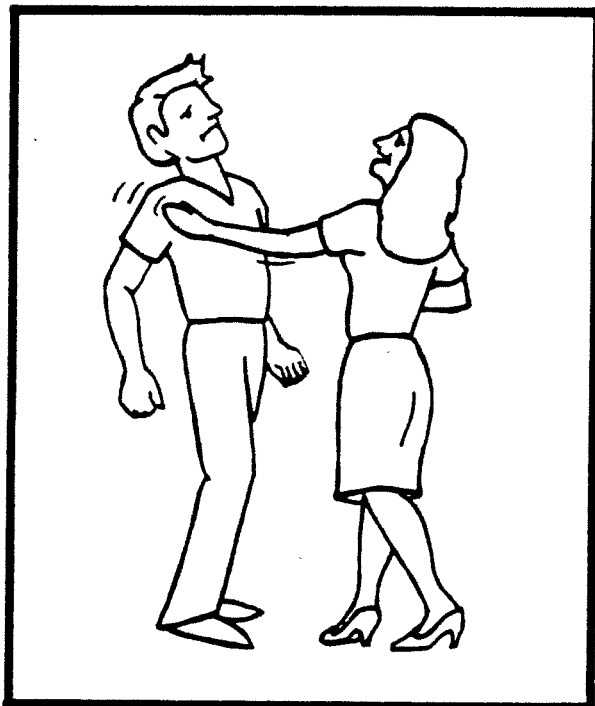

2

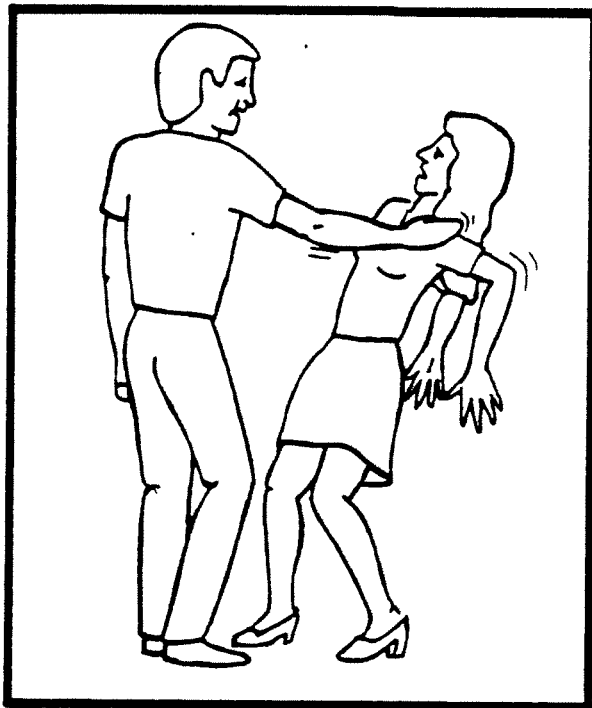

8

1

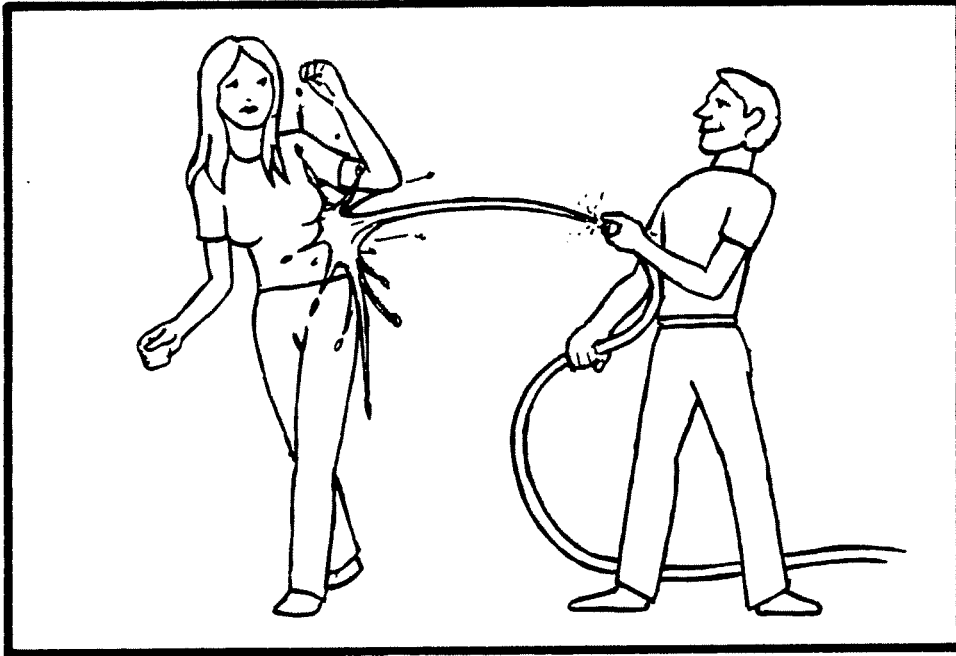

2

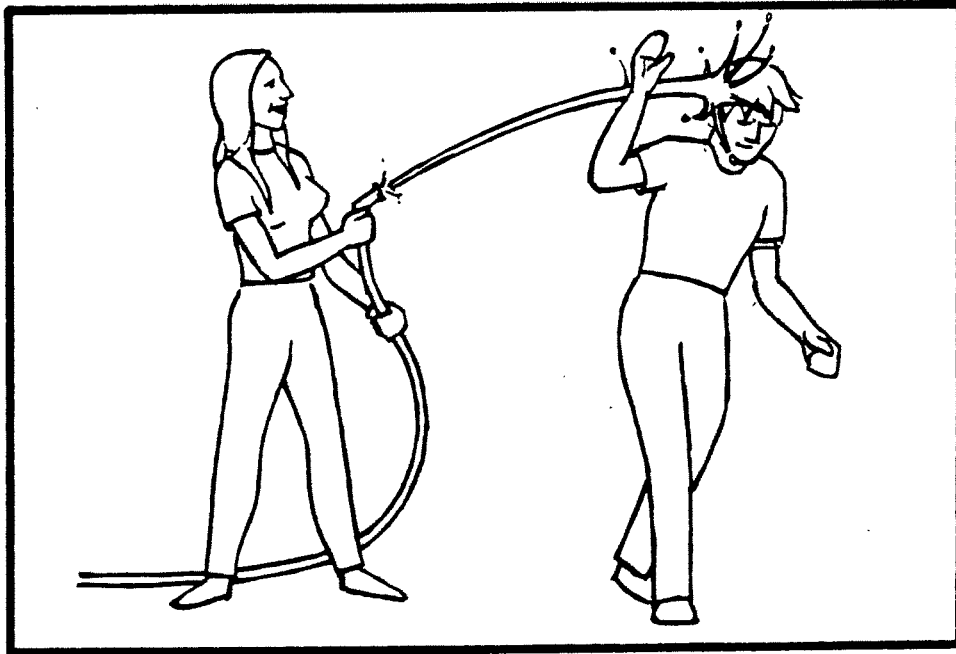

9

1

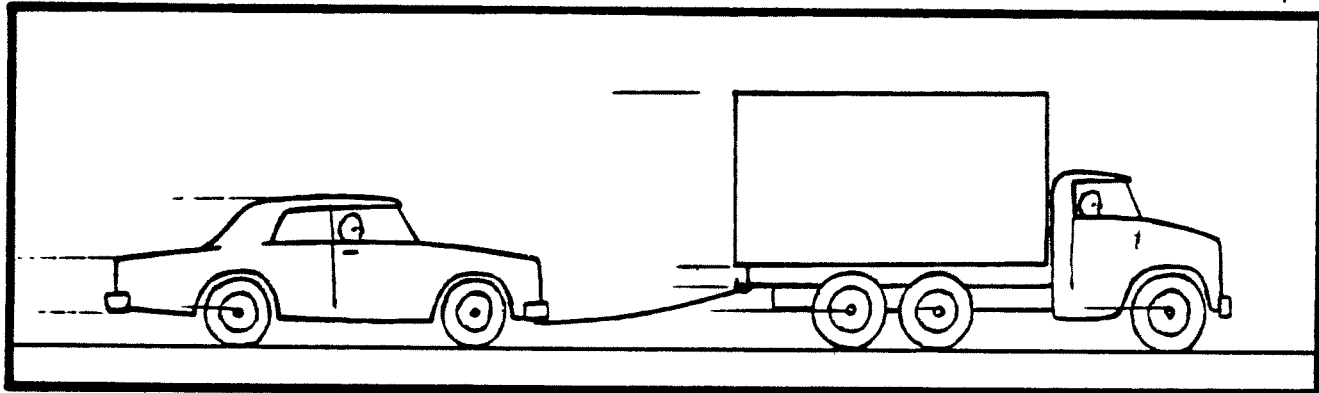

2

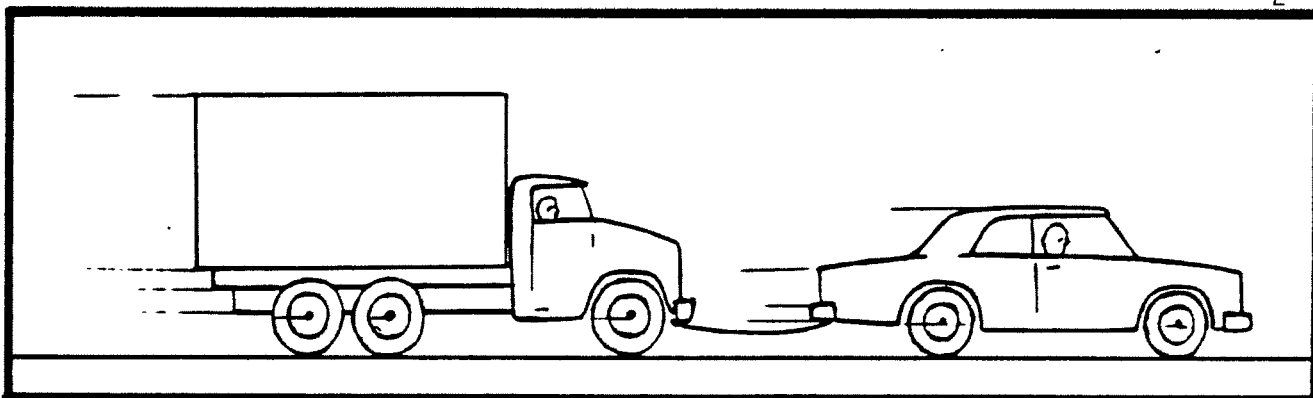

10

1

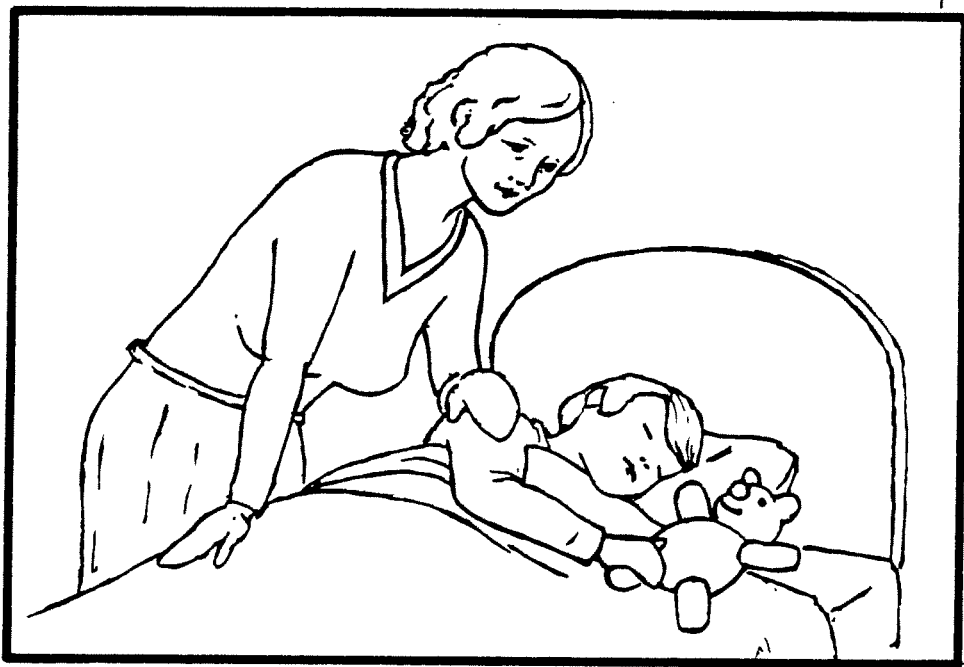

2

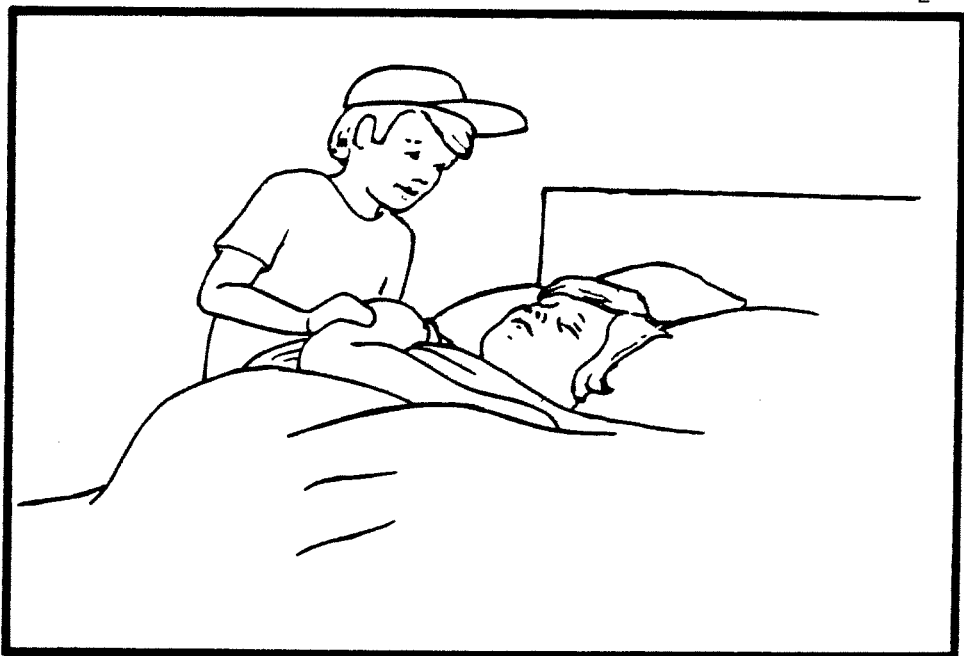

11

1

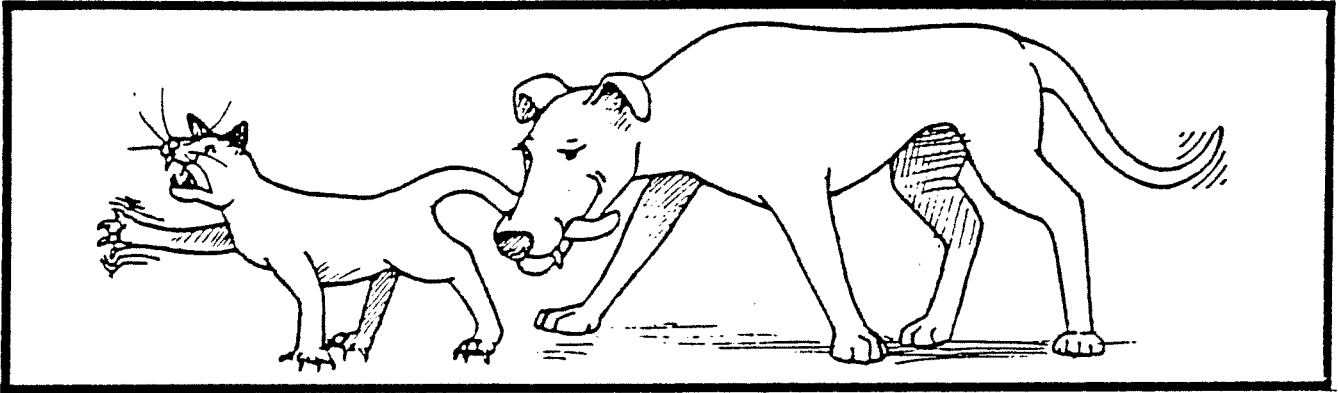

2

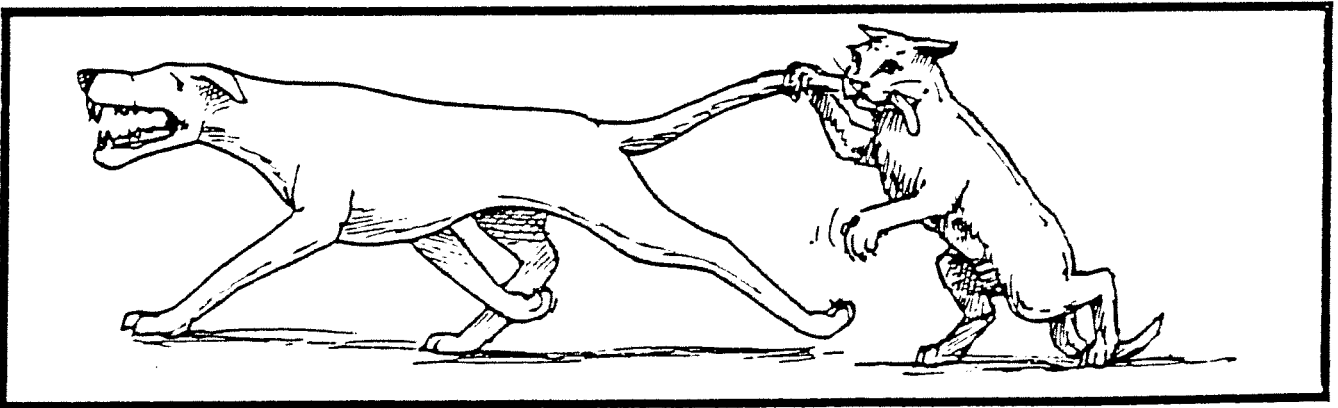

12

1



2



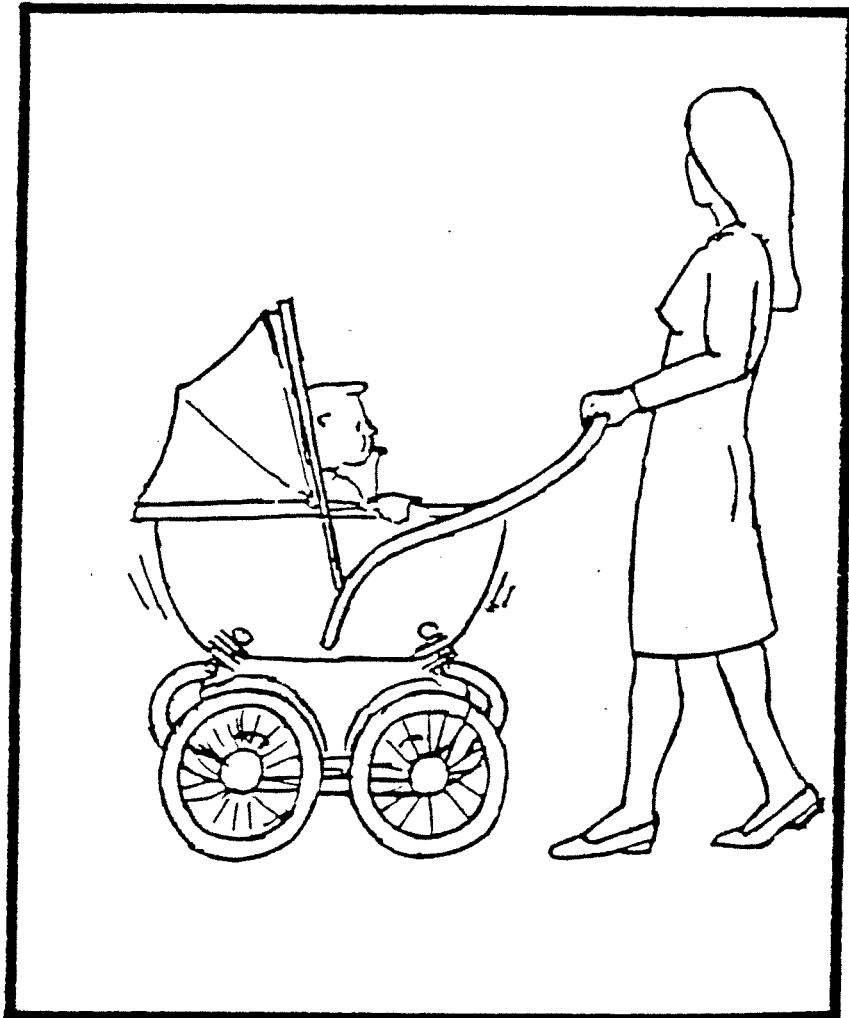

1

2

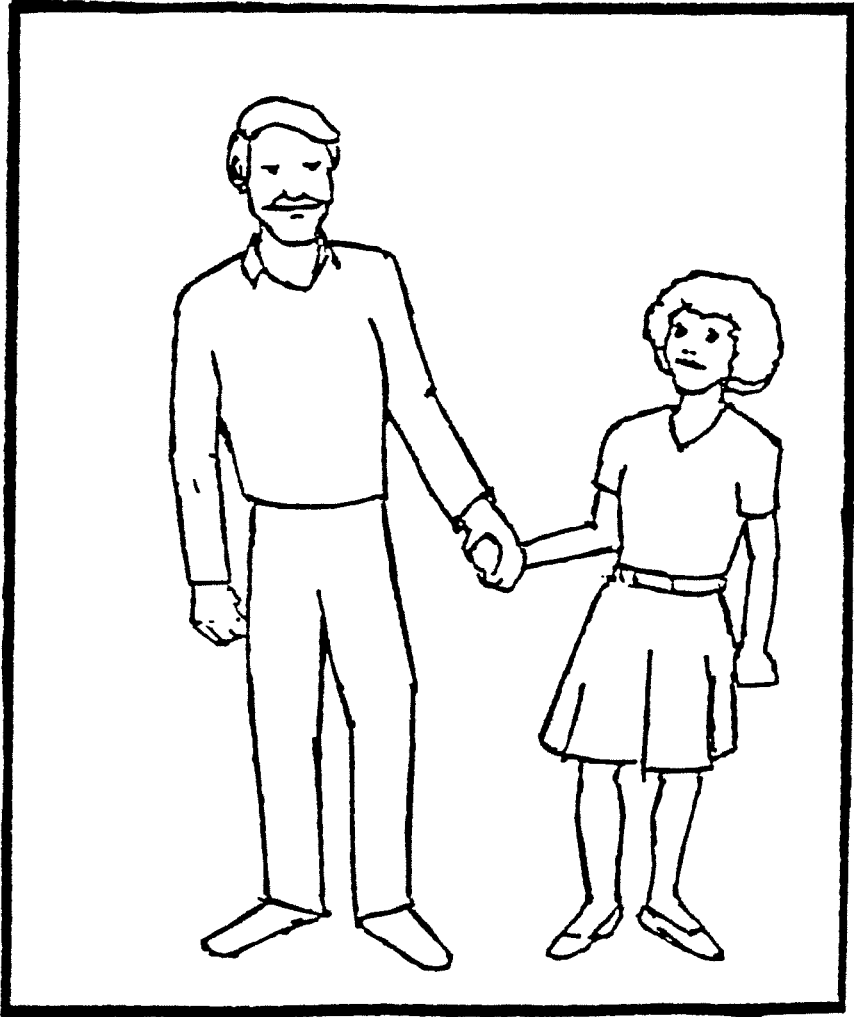

1

2

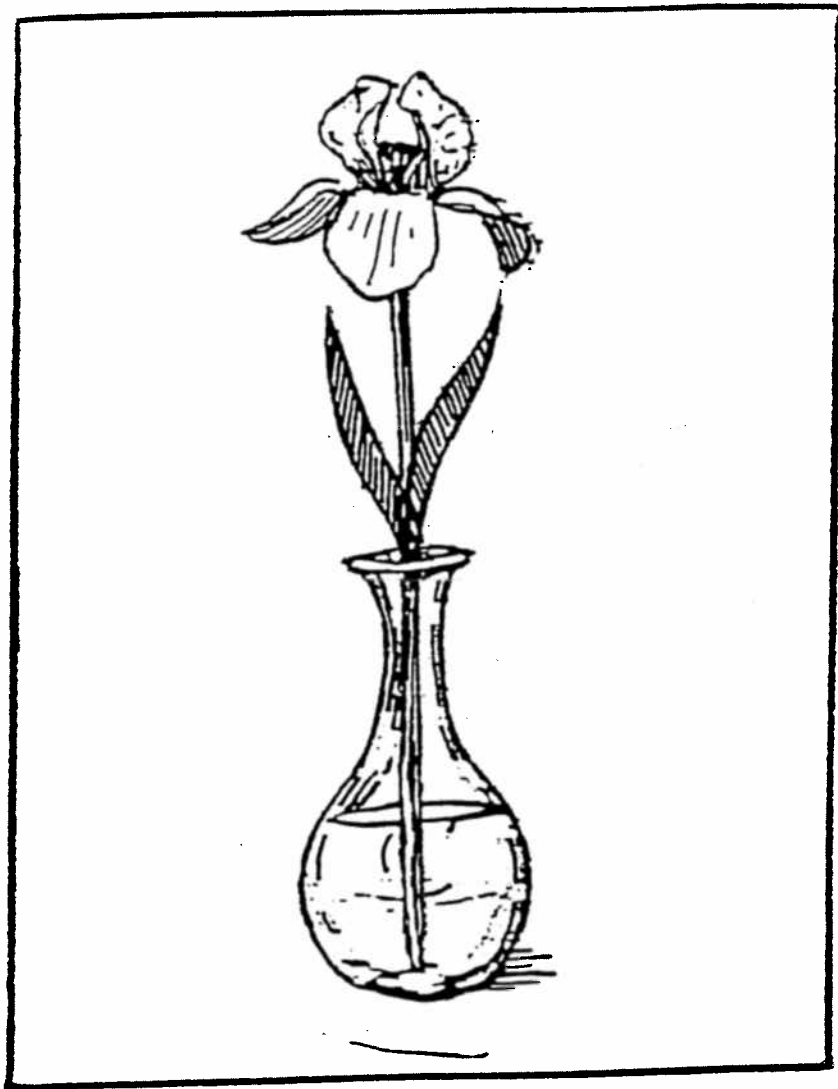

1

2

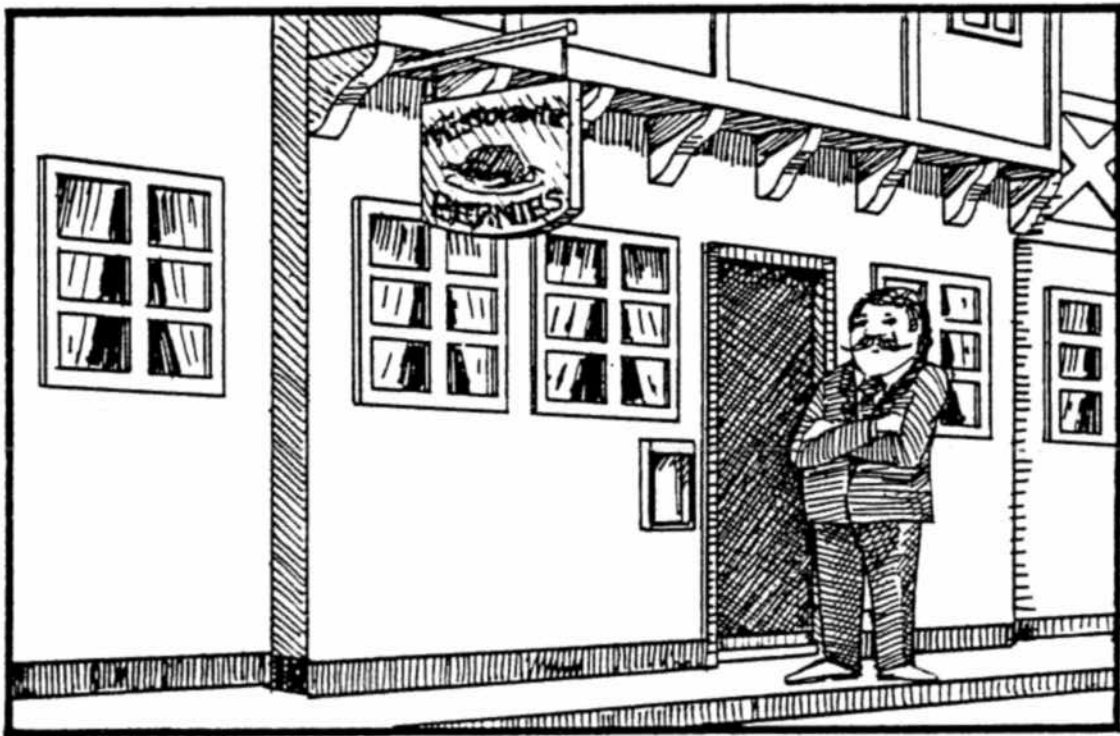

2

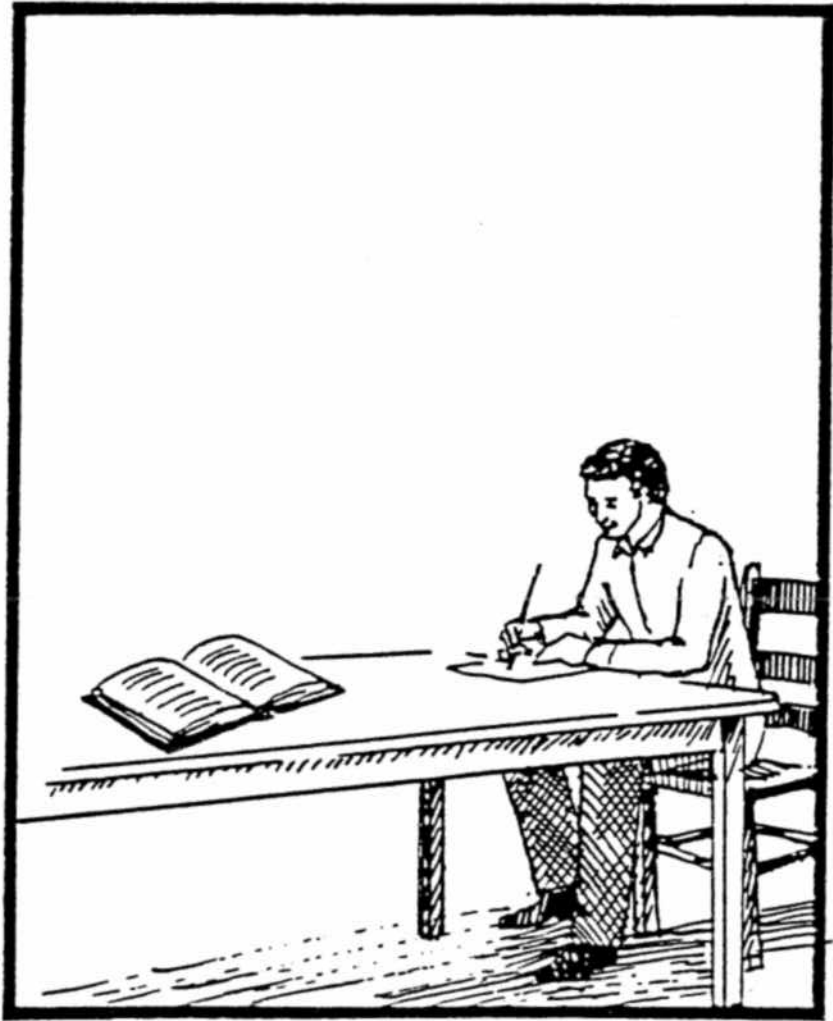

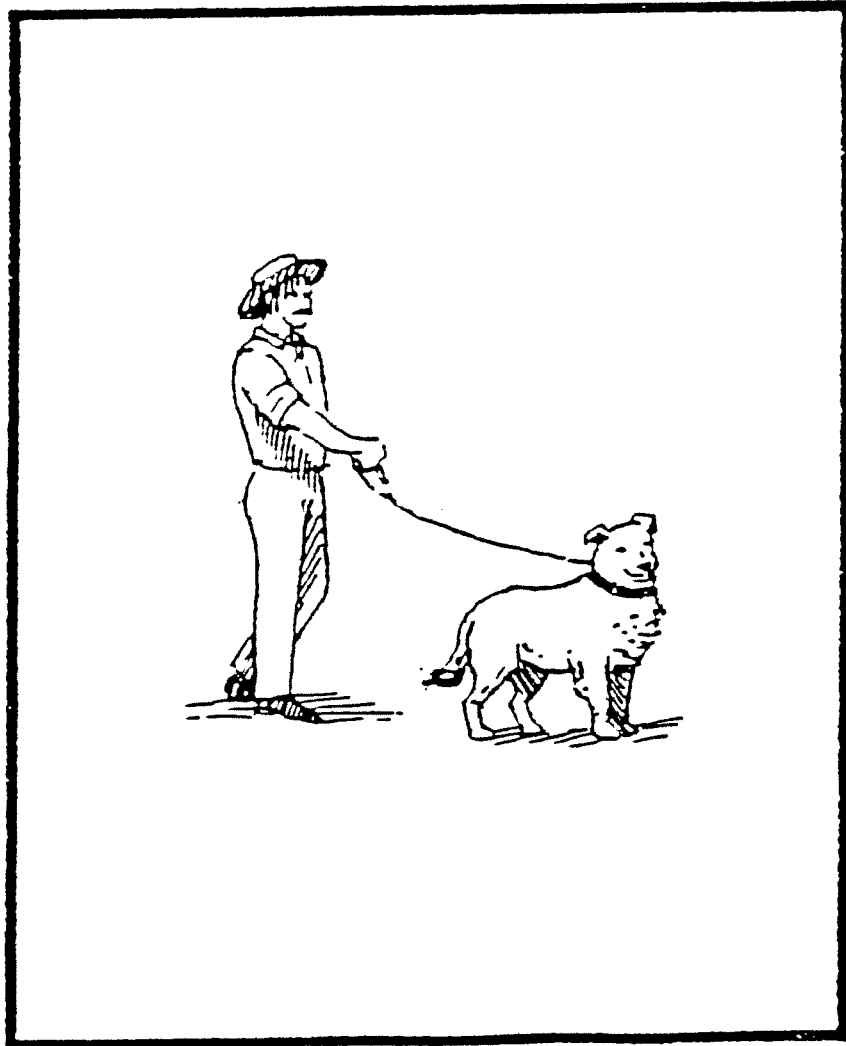

1

2

1



2

1

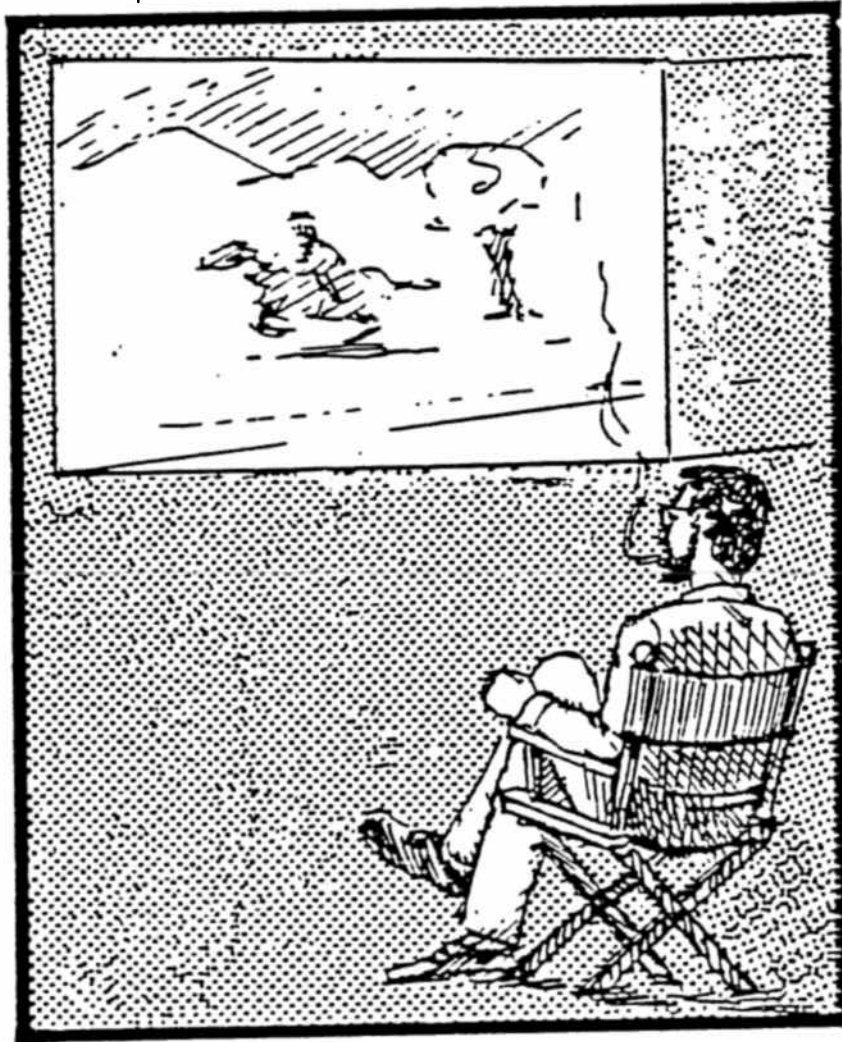

2

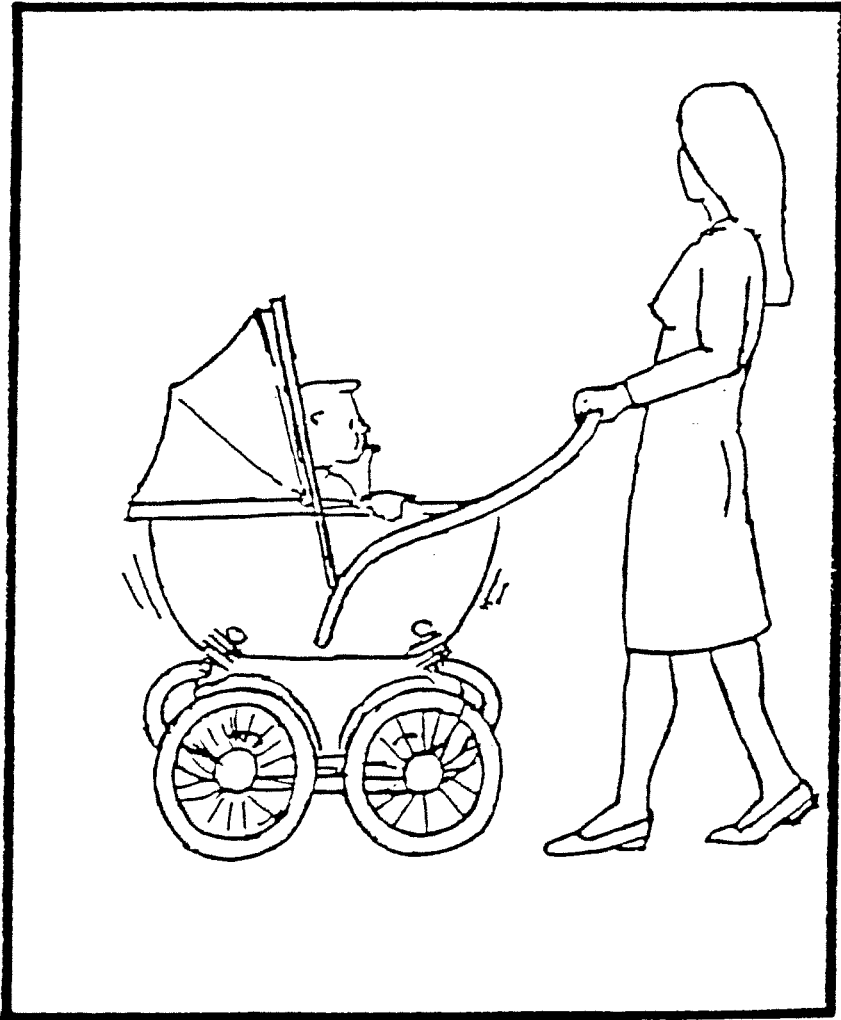

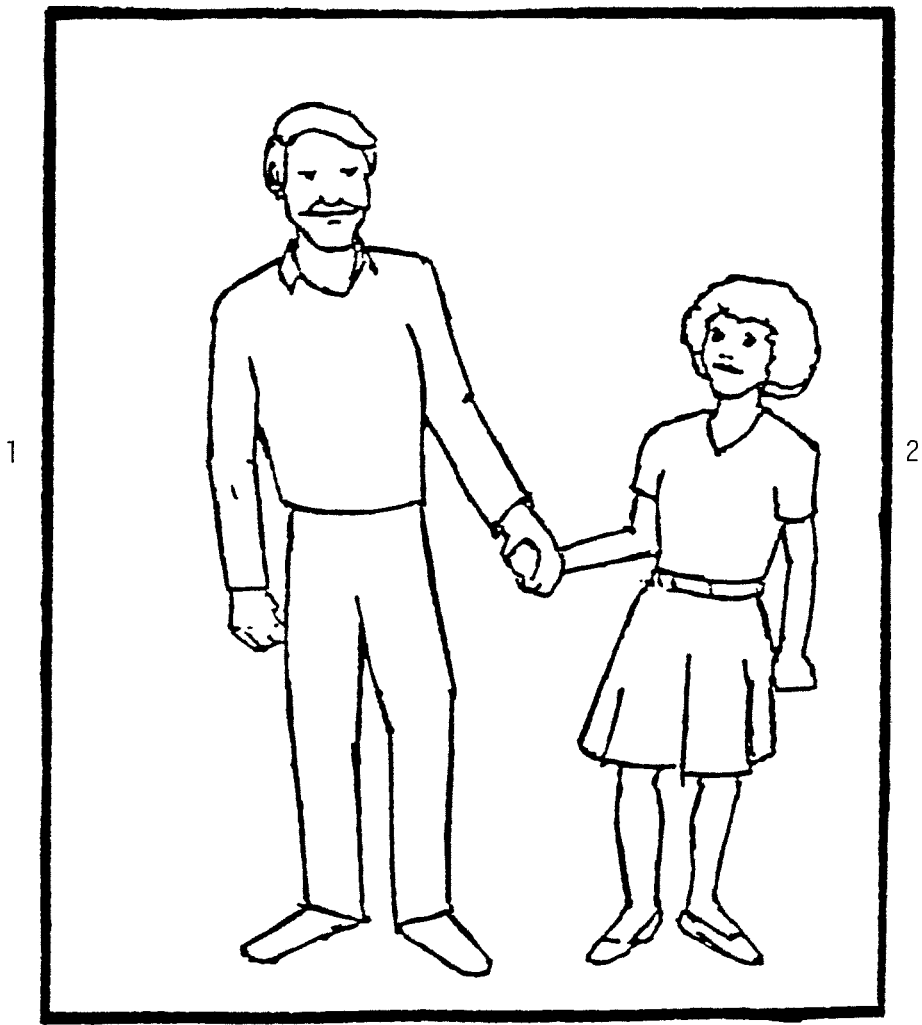

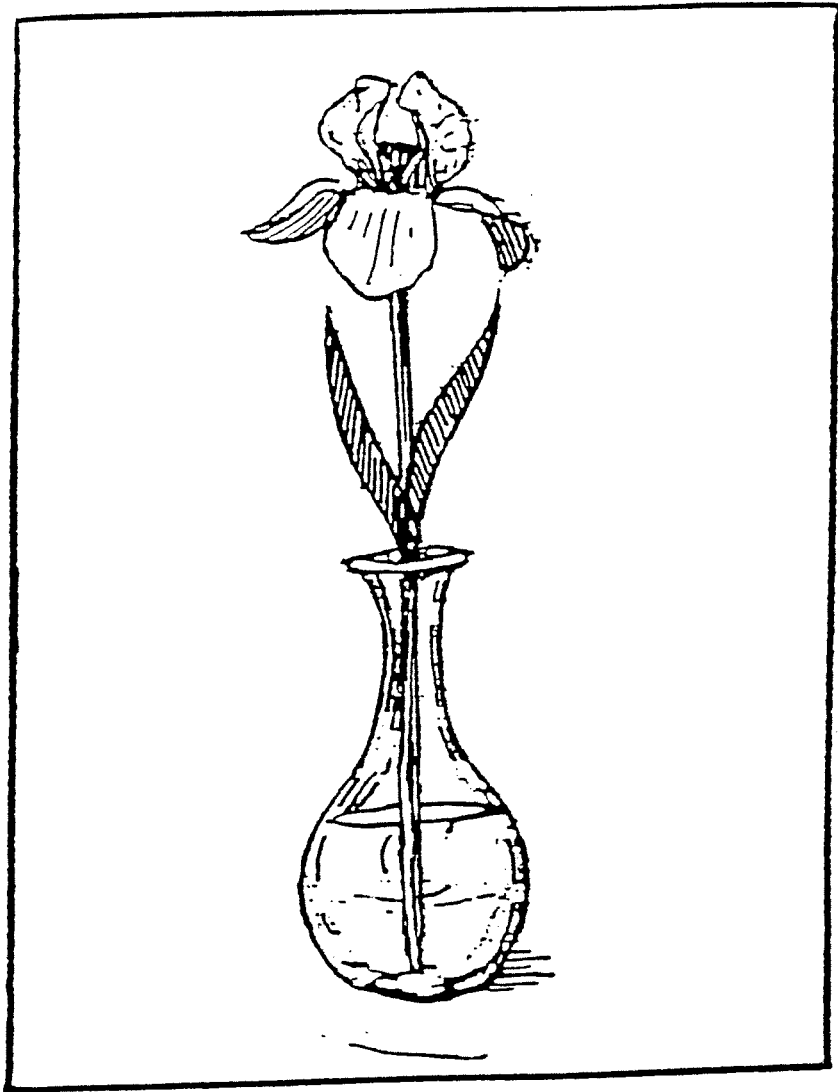

1

2

1

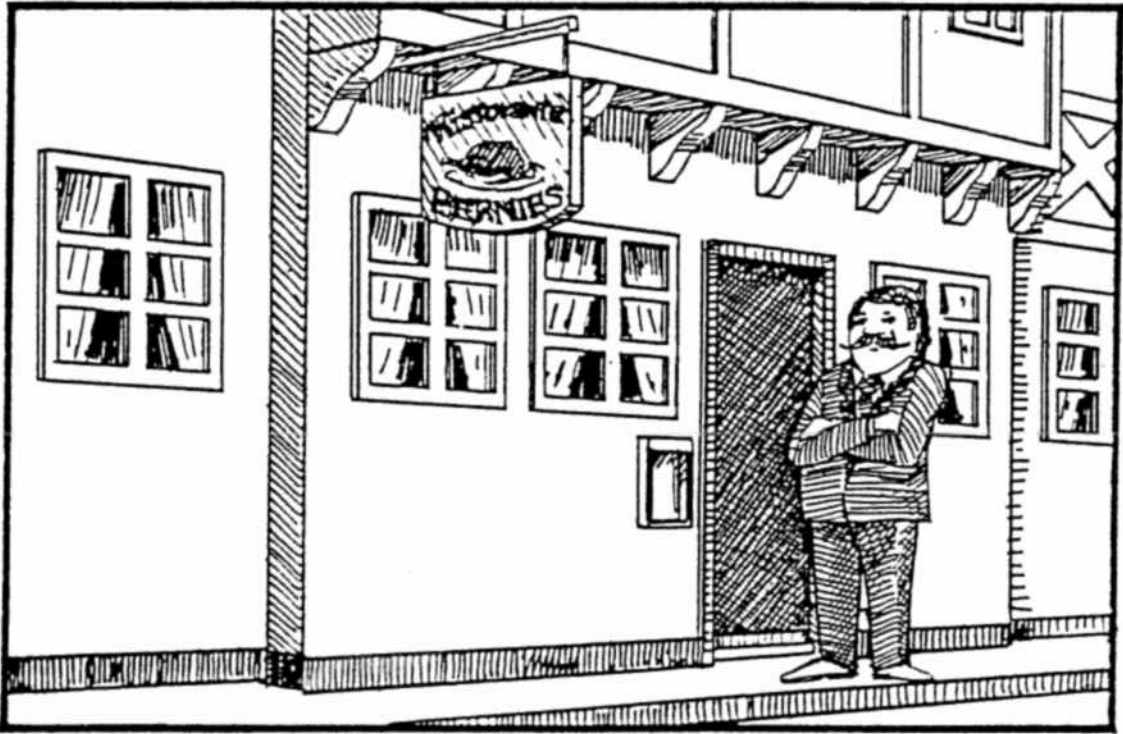

2



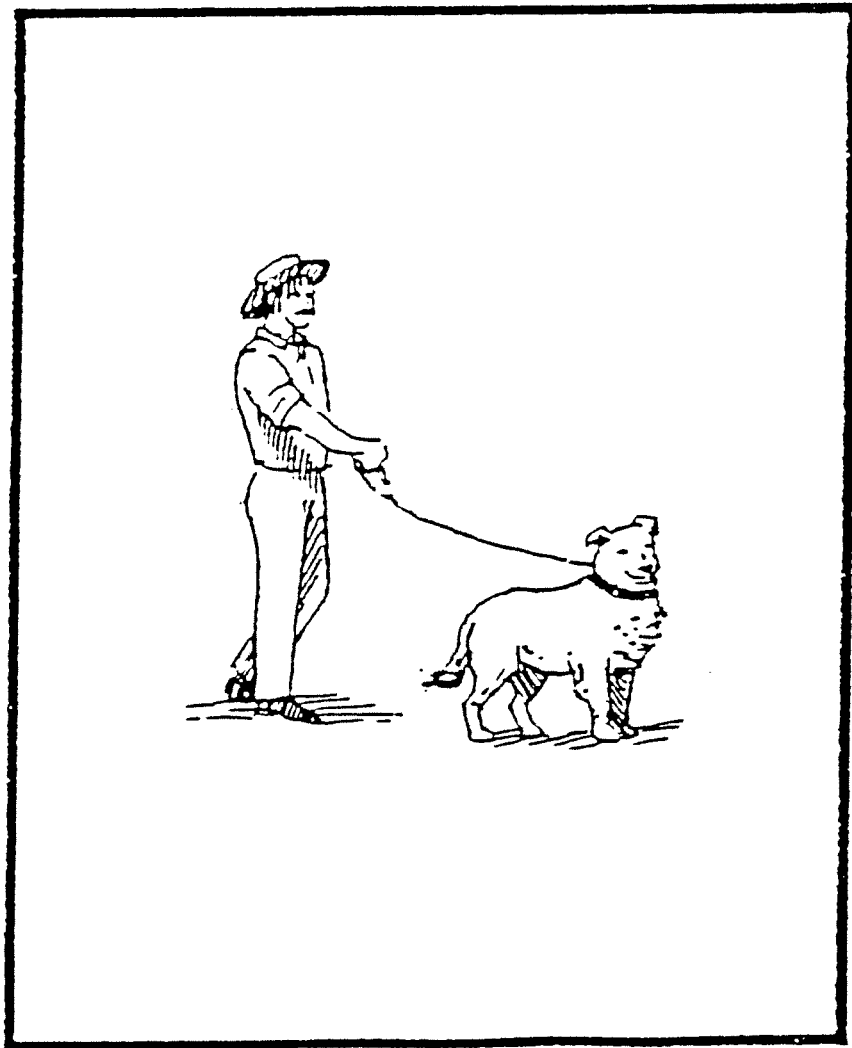

1

2

1



1

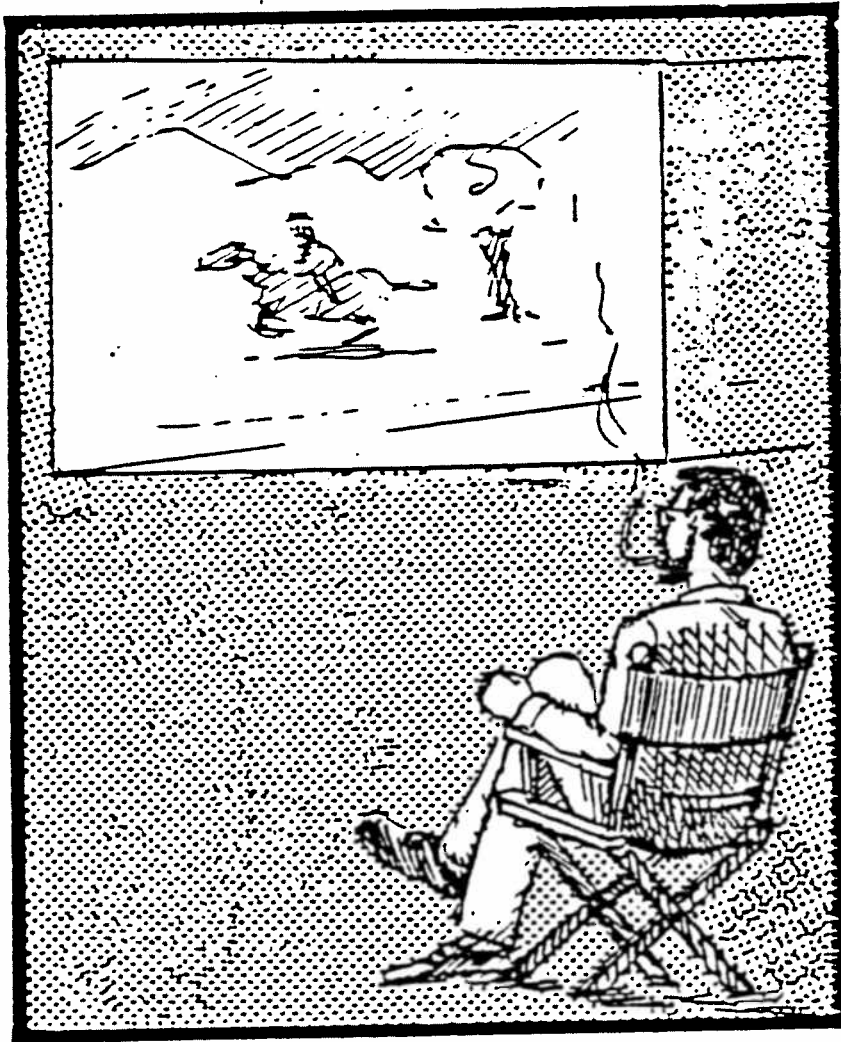

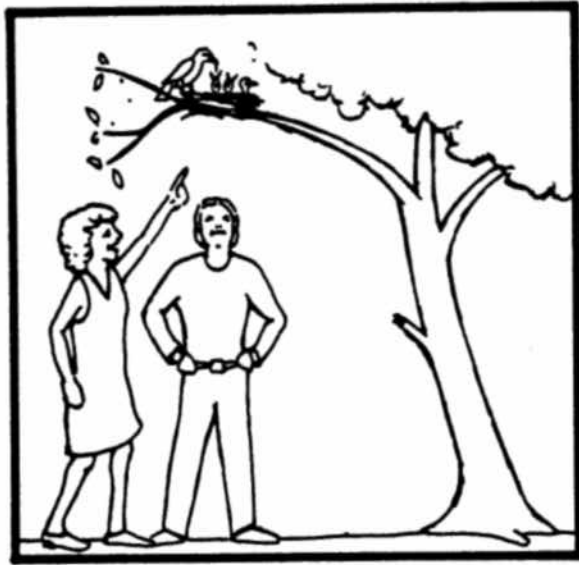

КОТ

ТАЧКА

ТОРТ

ПЕЧКА

ЛАПКА

ёлка

жук

шайка

сок

сетка

Мальчик держит девочку.

Он умывается.

Собака укушена кошкой.

Это грузовик, который тянет автомобиль.

Мальчик не толкает девочку.

Грузовик не тянется автомобилем.

Это собака, которую кошка кусает.

Он держит её.

Женщина, которую не целует мужчина.

Девочка, которую толкает мальчик.

Женщина со своим сыном отправились в поле собрать овощей. Они собрали шесть кочанов капусты и возвратились в деревню. Они пошли к соседям на ферму и обменяли капусту на молоко.

ТОЛСТЫЙ

стружка

кран

тарелка

КОЛКНИ

слуховое восприятие слов

KOT

1

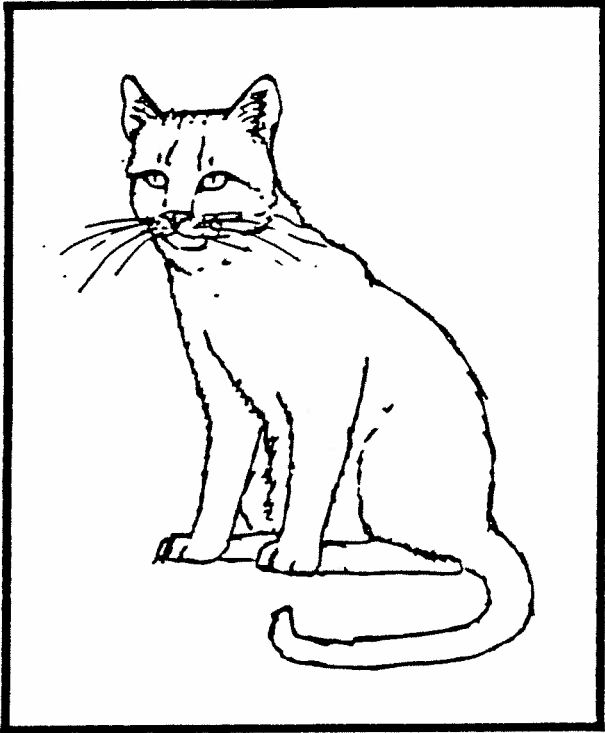

2

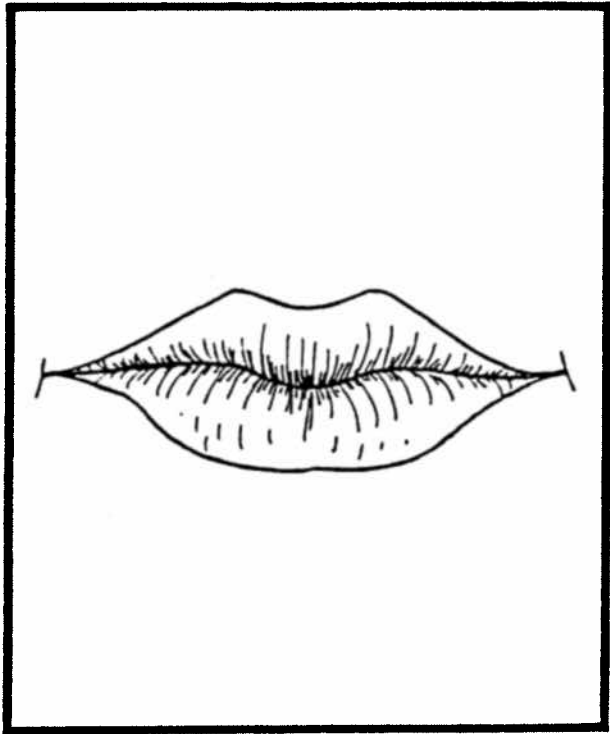

3

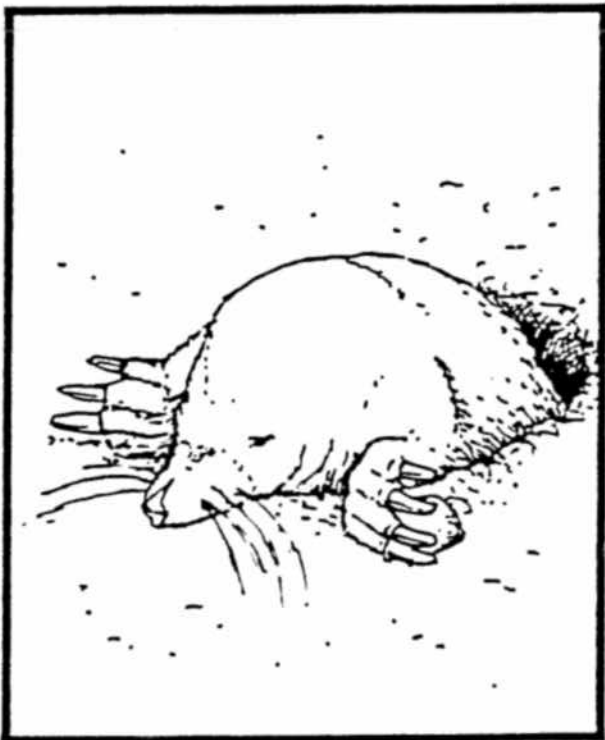

4

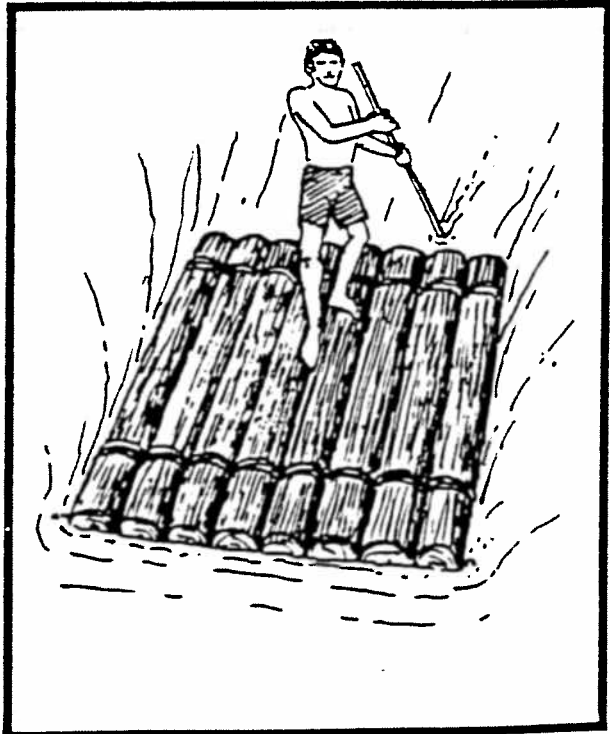

качка

1



2

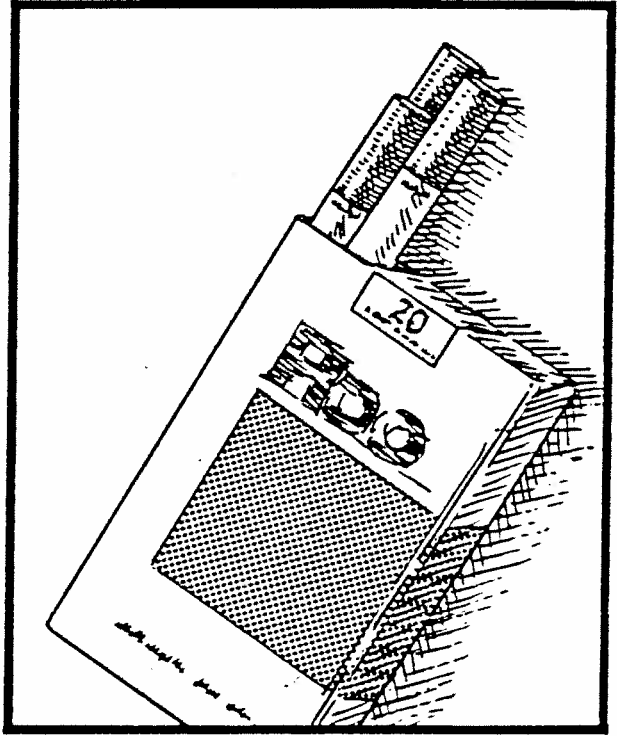

3



4



ТОРТ

1

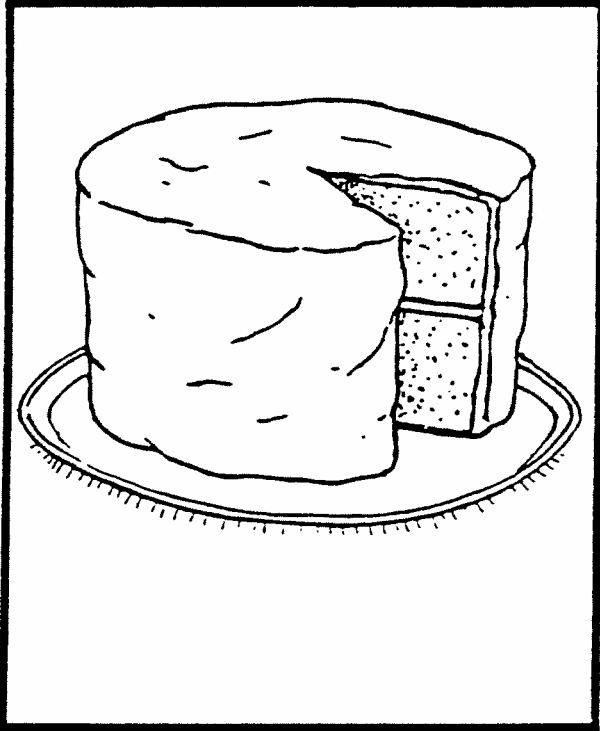

2

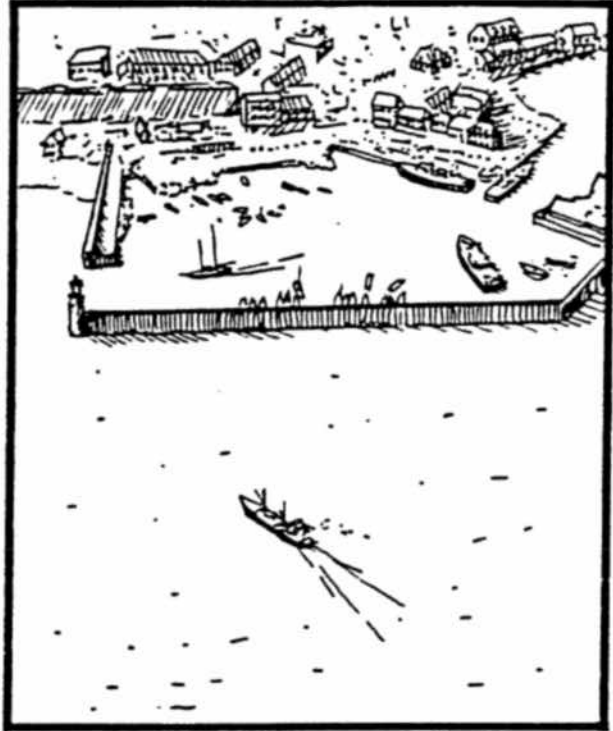

3

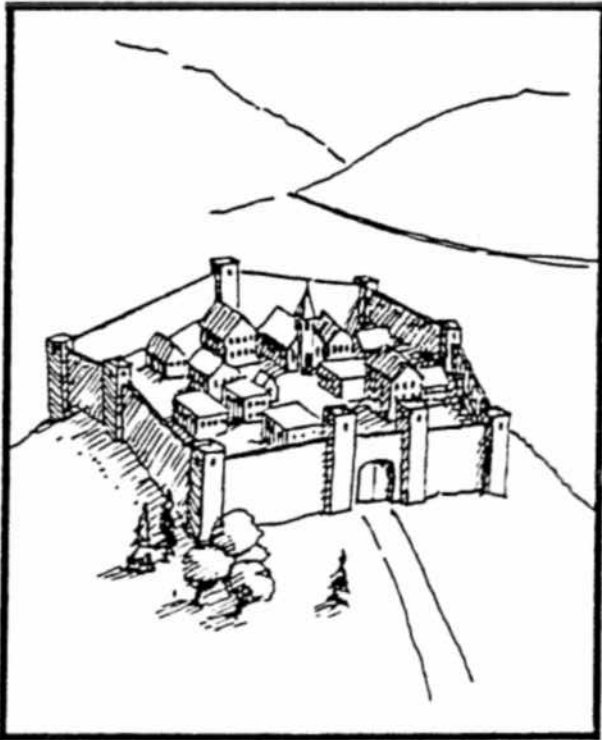

4

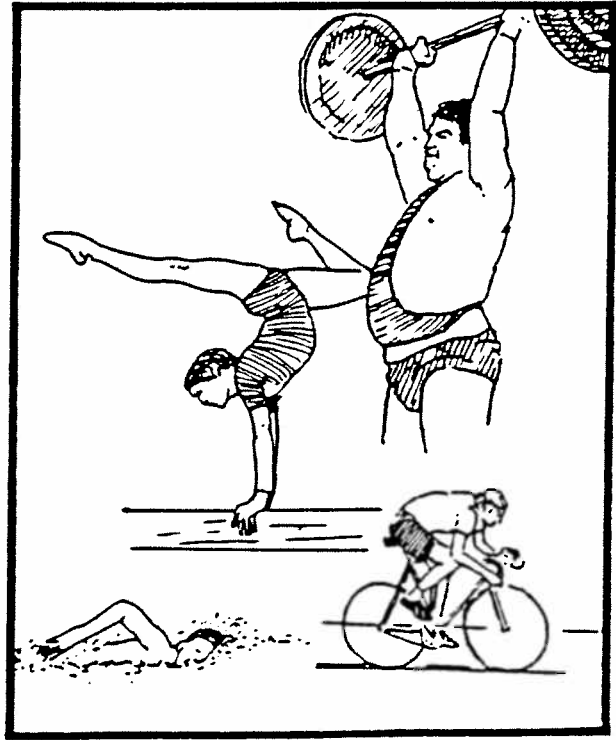

печка

1

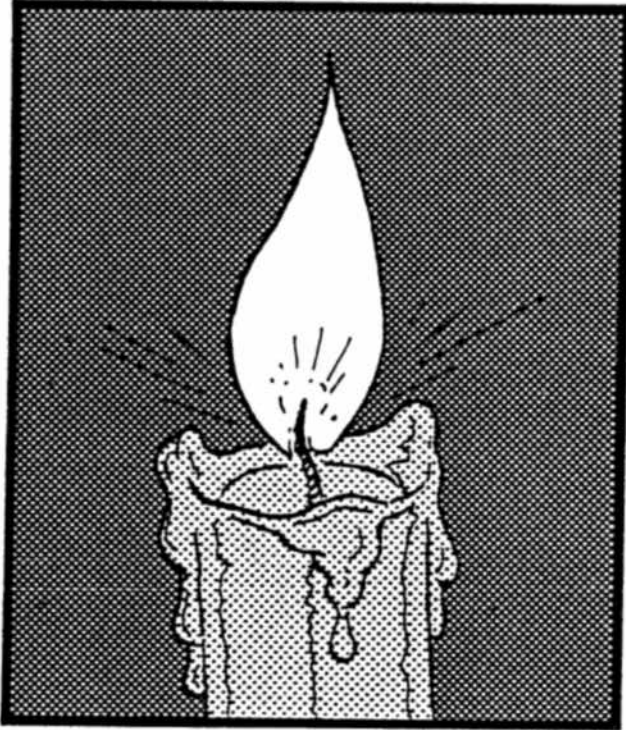

2

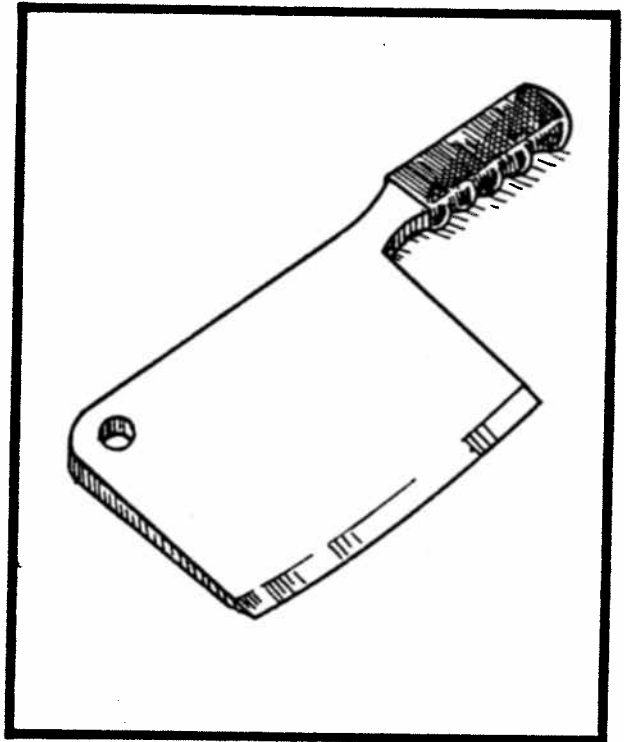

3

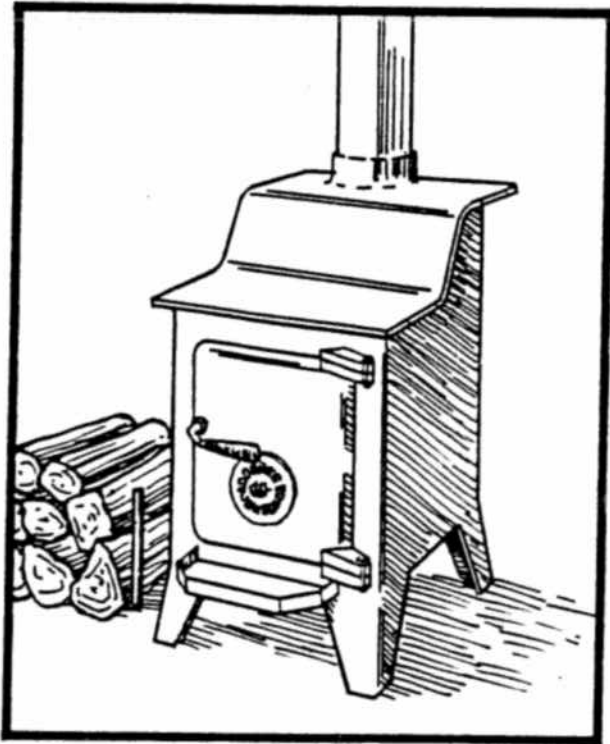

4



лапка

1



2

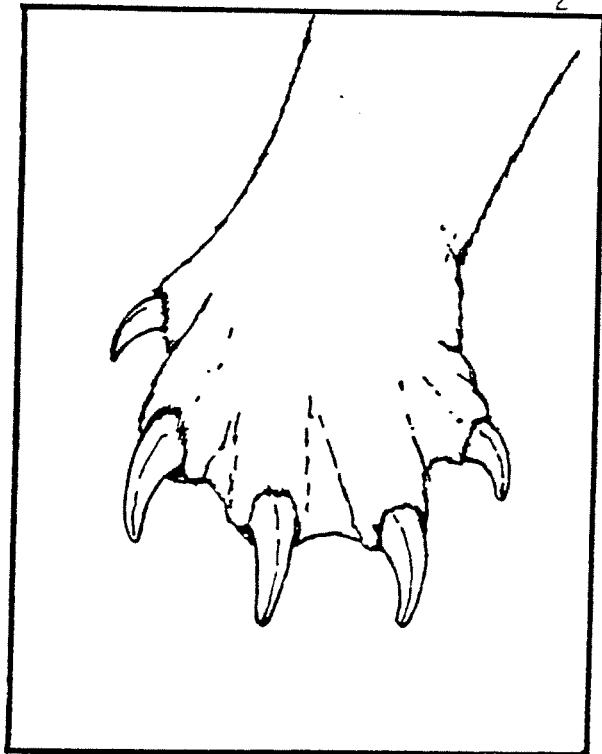

3

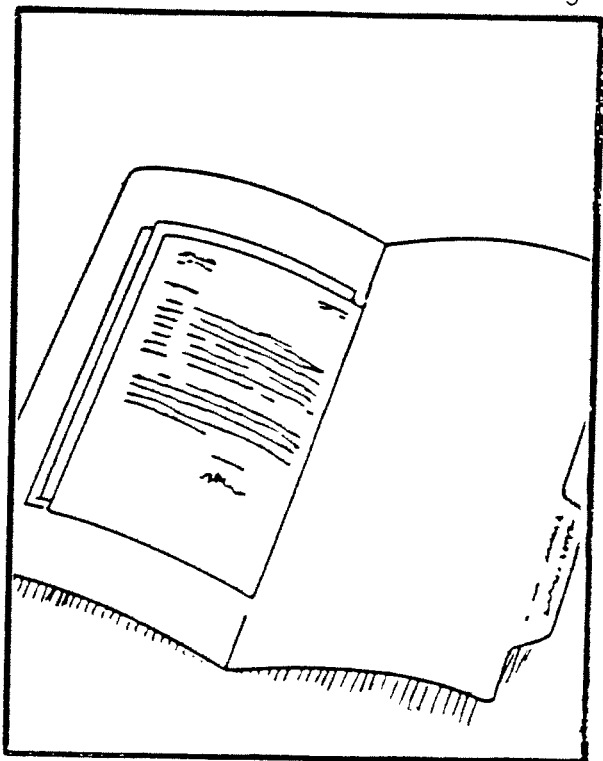

4



ёлка

1

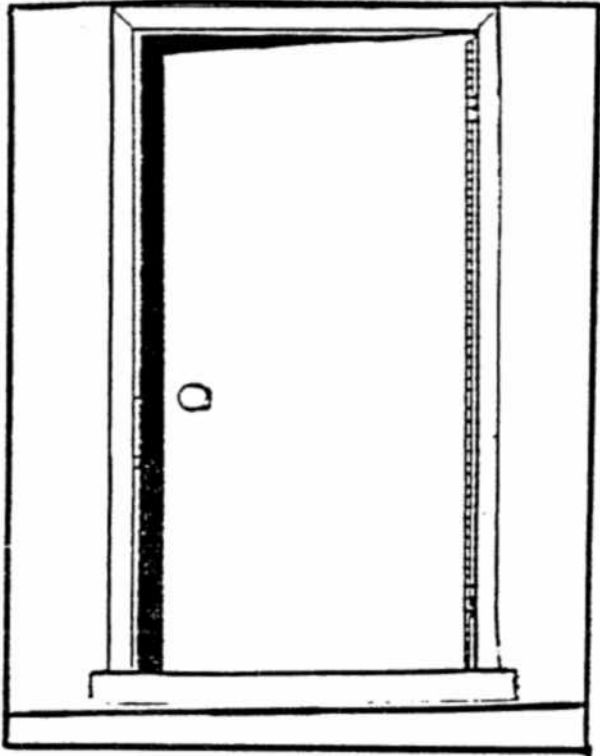

2

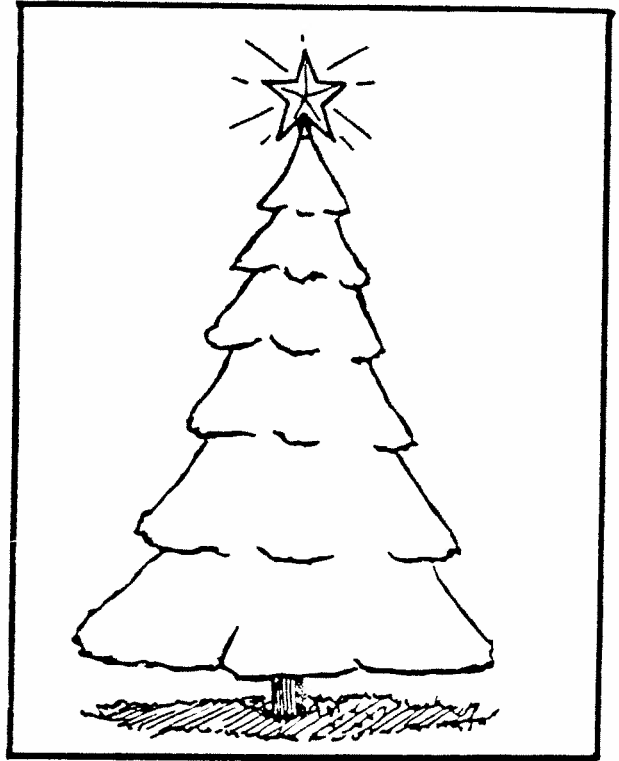

3

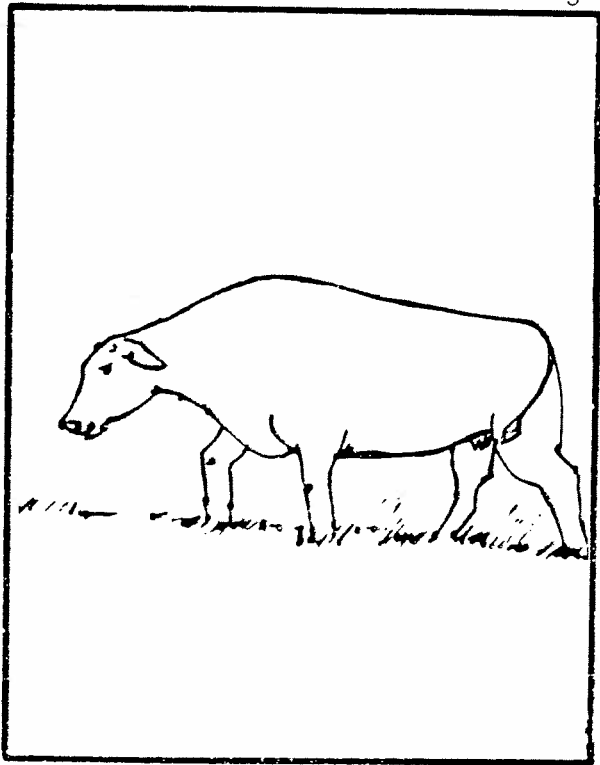

4

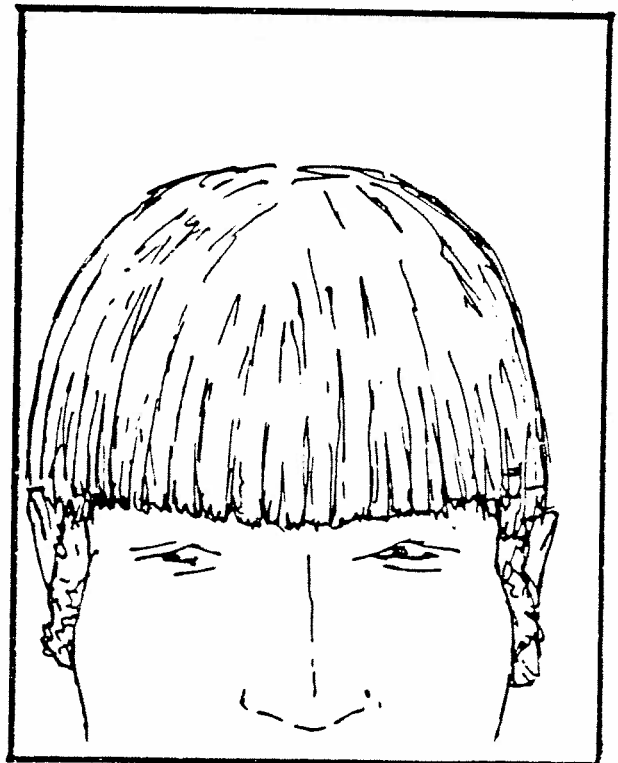

жук

1

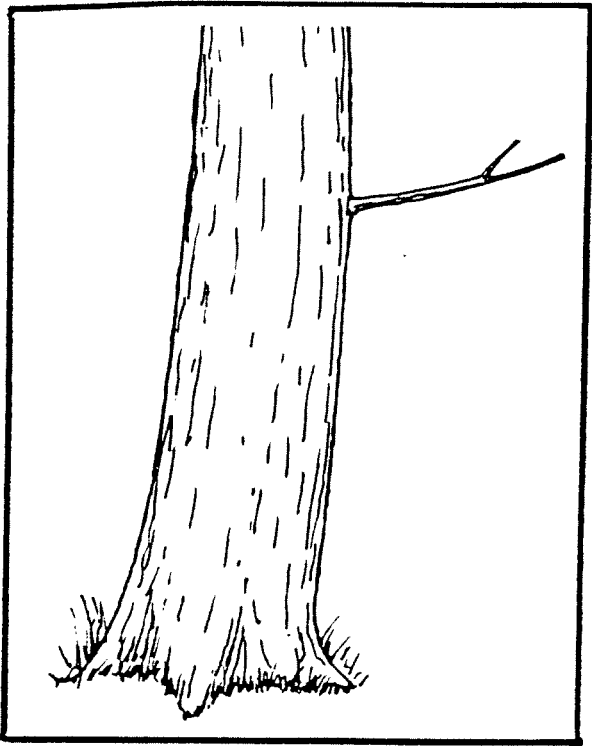

2

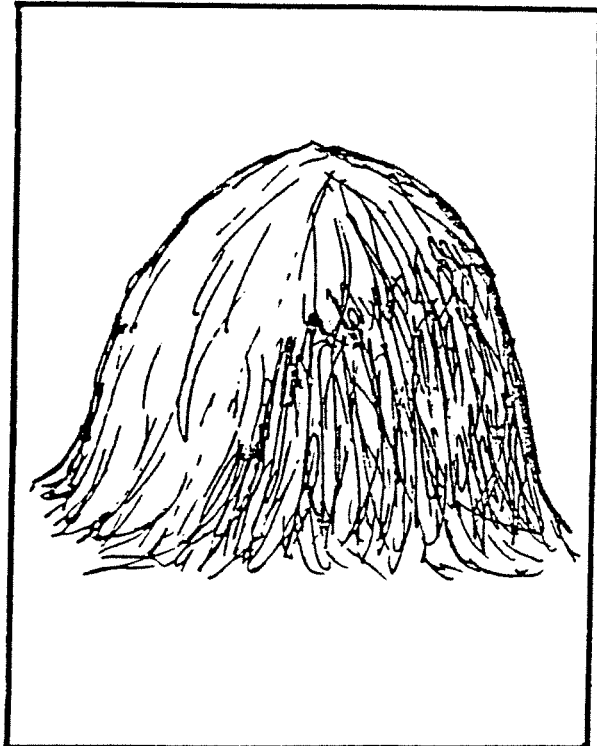

3

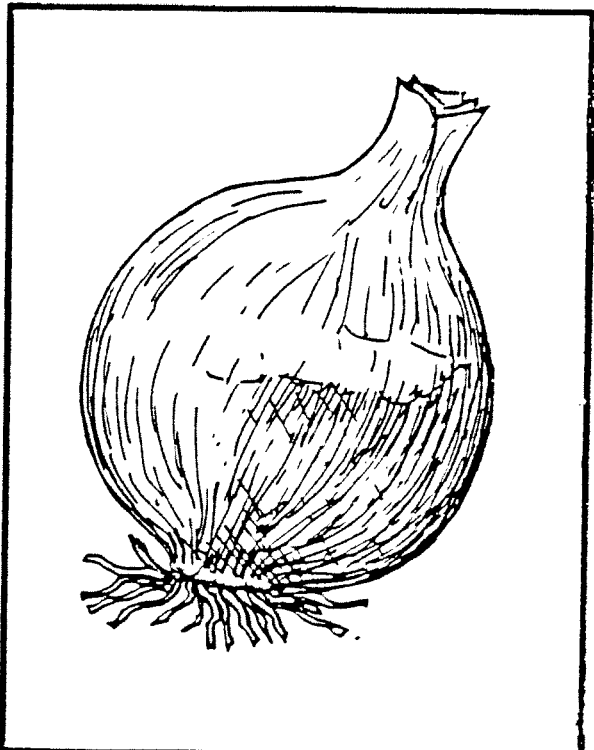

4

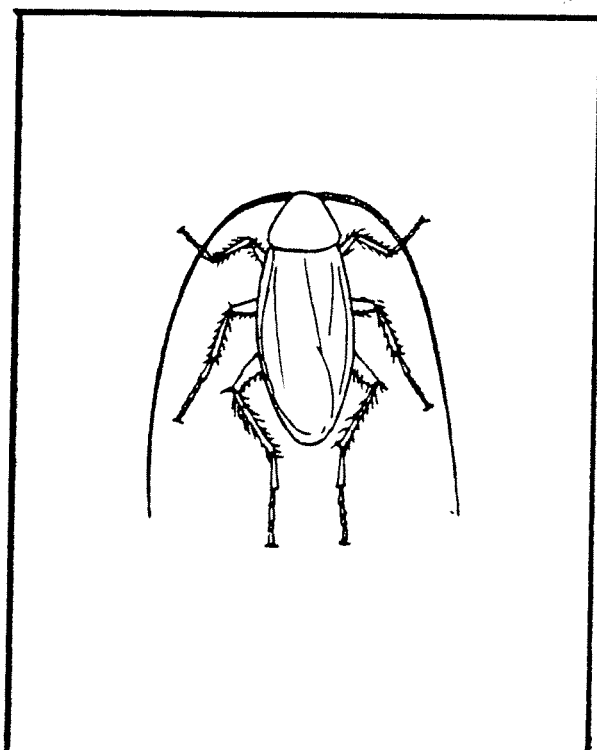

шайка

1

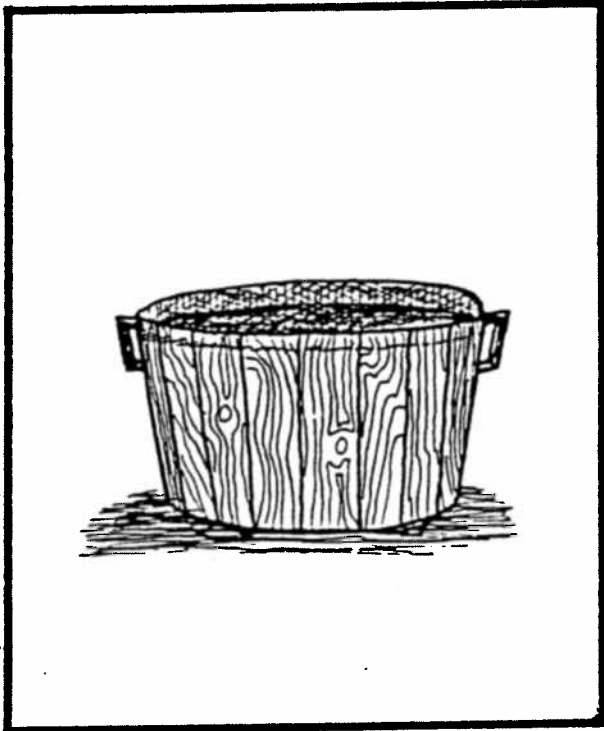

2

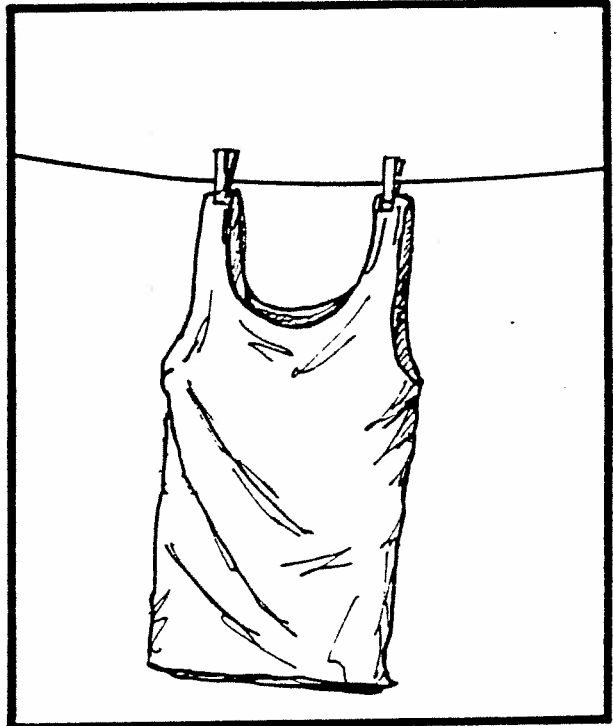

3

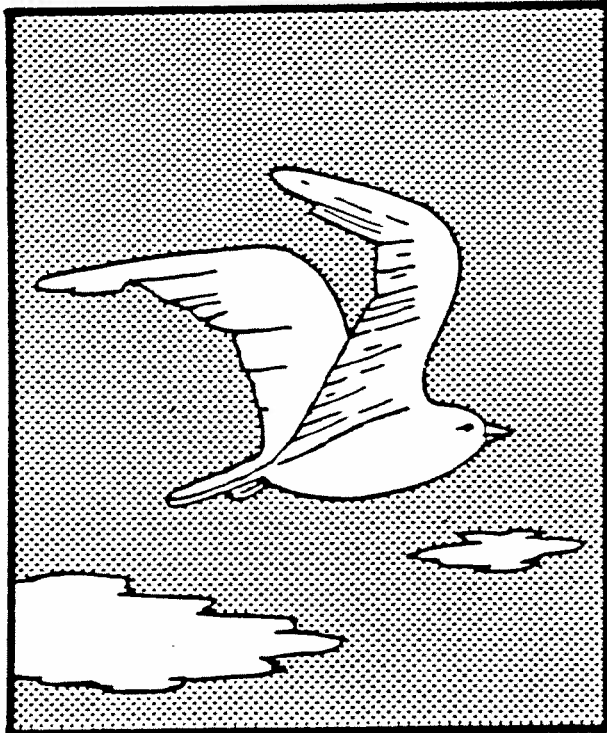

4

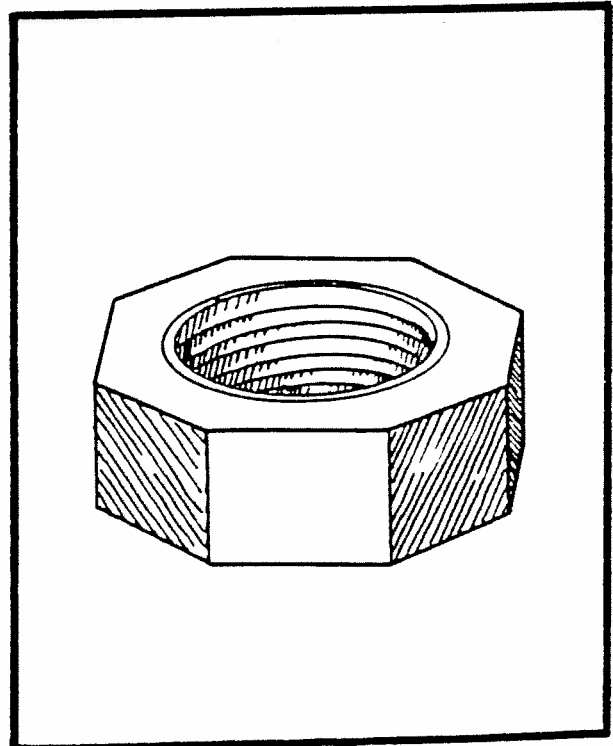

COK

1

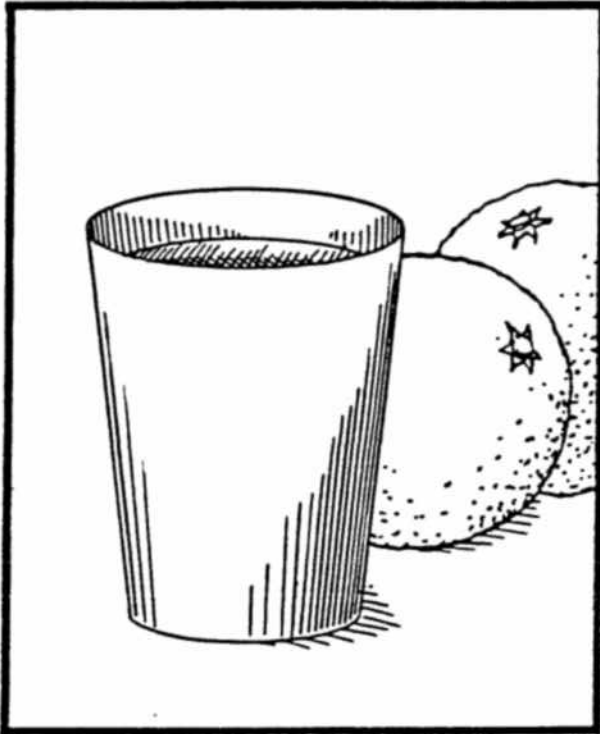

2

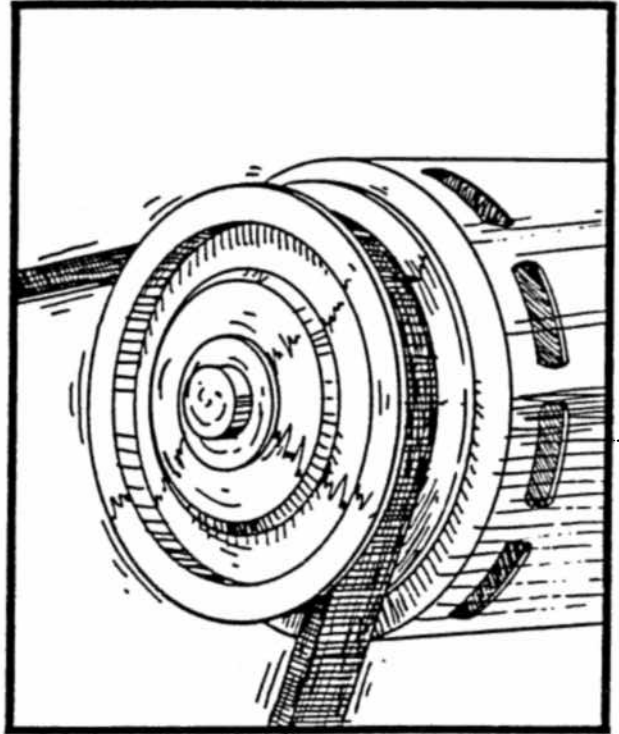

3

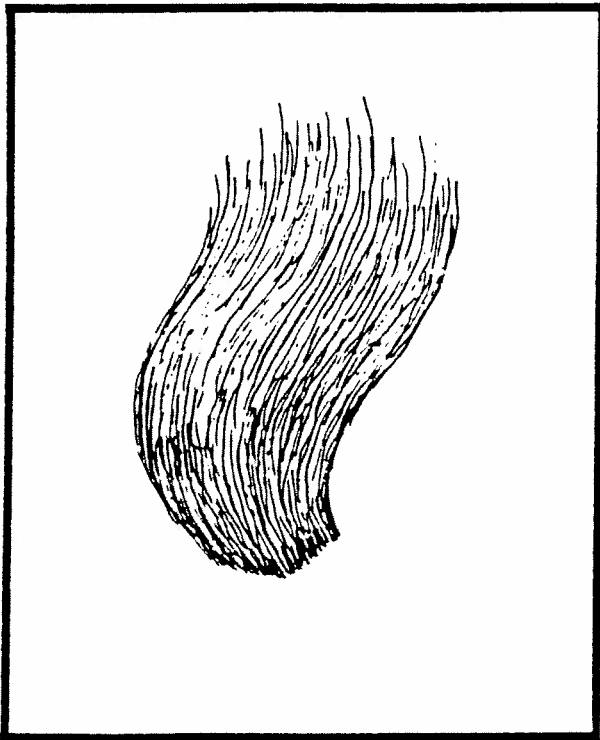

4

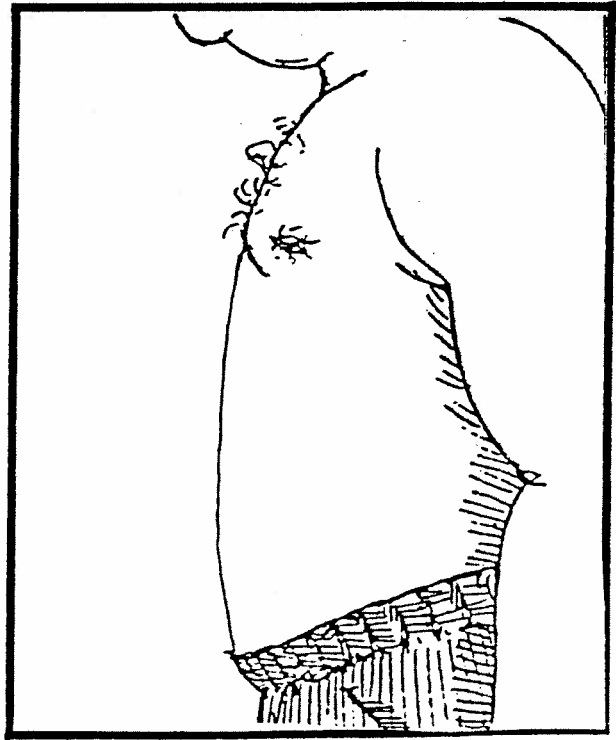

сетка

1



2

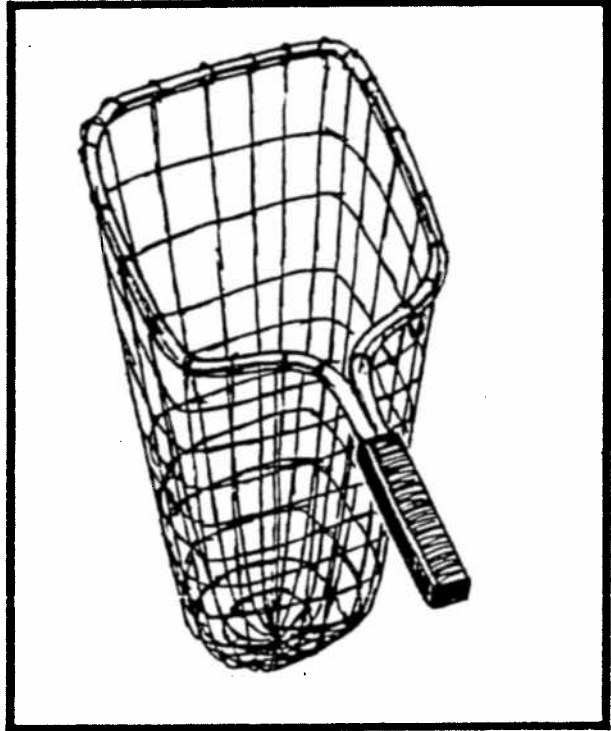

3

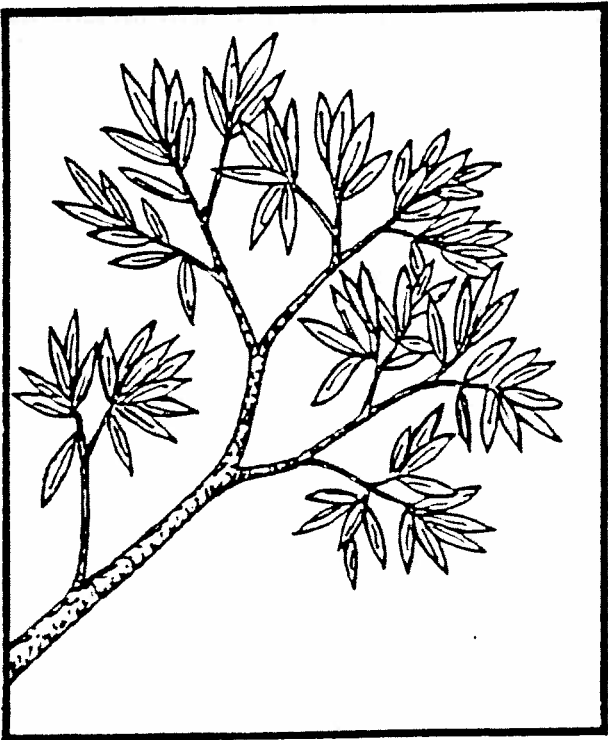

4

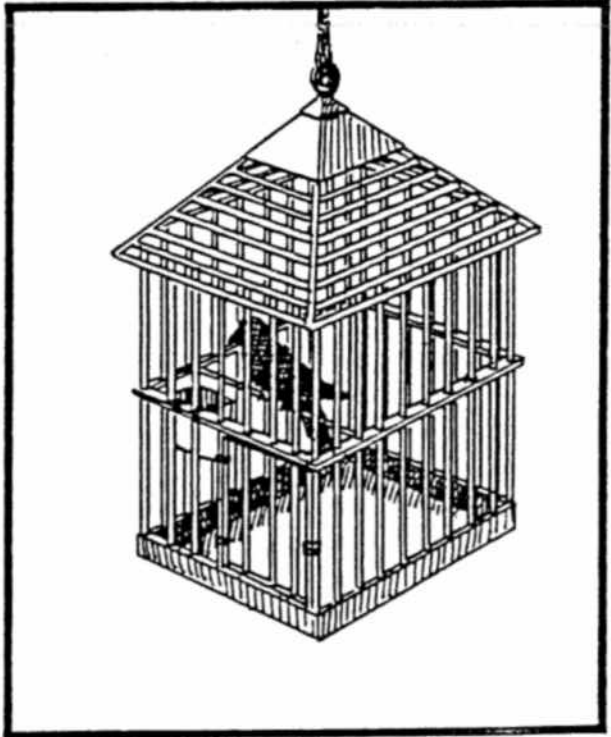

слуховое восприятие предложений

Мальчик держит девочку.

1

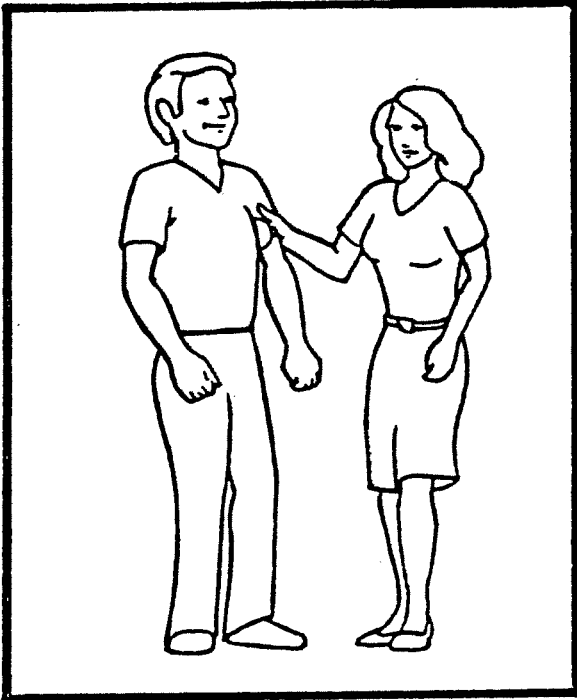

2

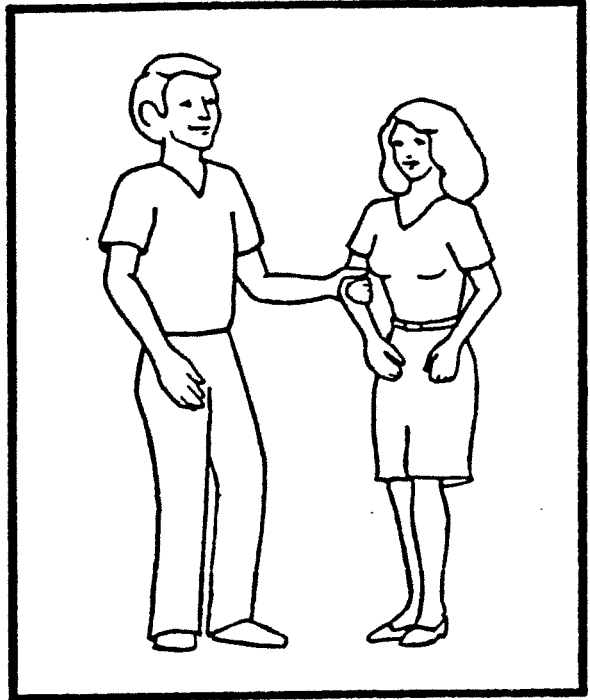

3

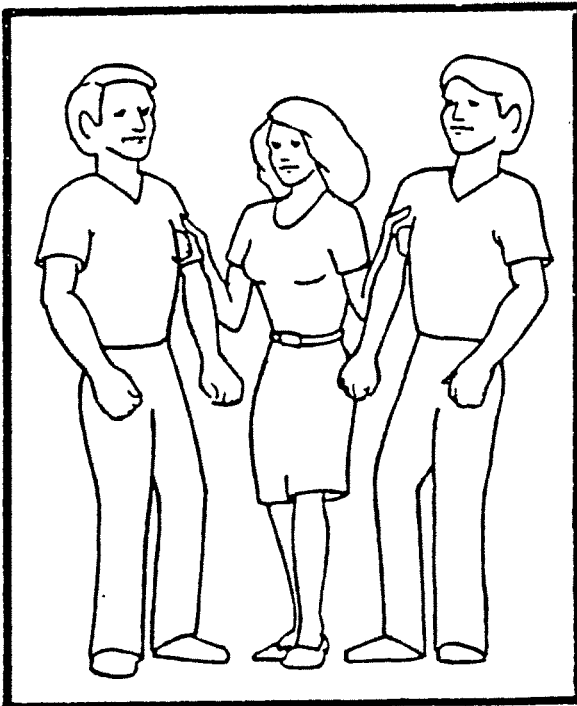

4

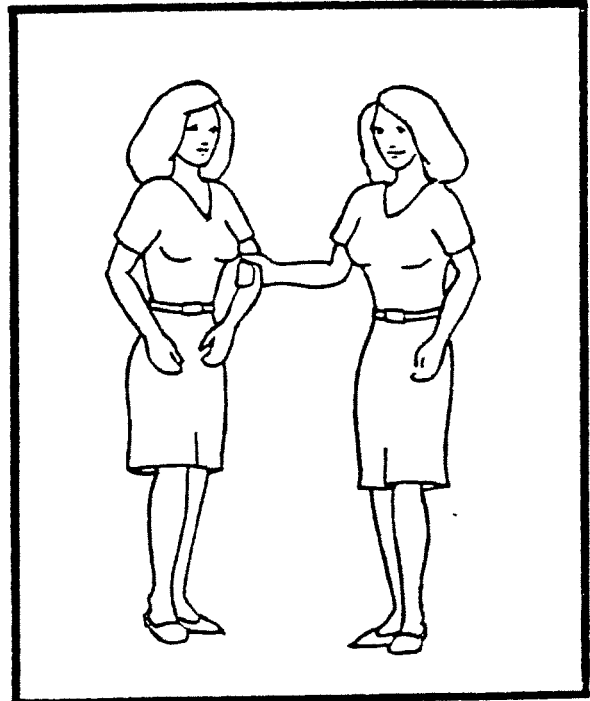

Он моется.

1

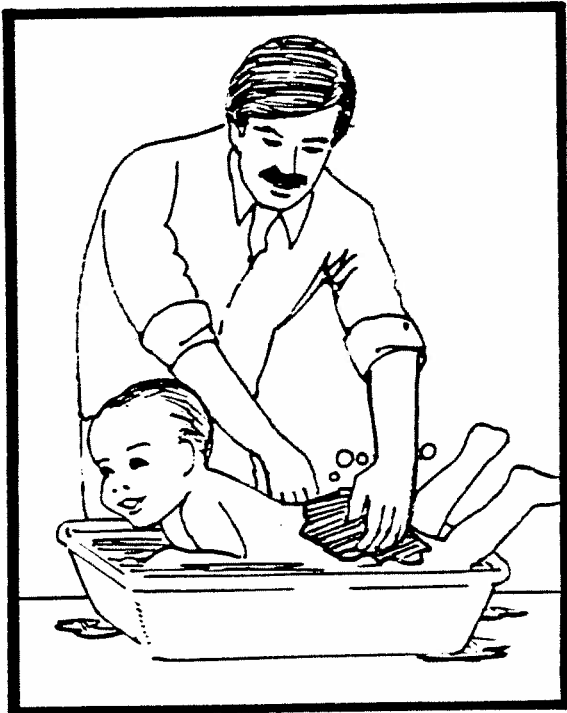

2



3

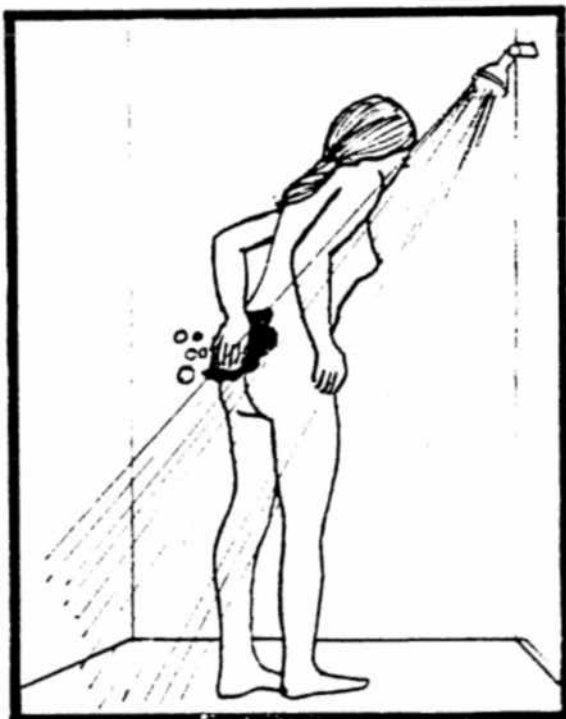

4



Собака укушена кошкой.

1

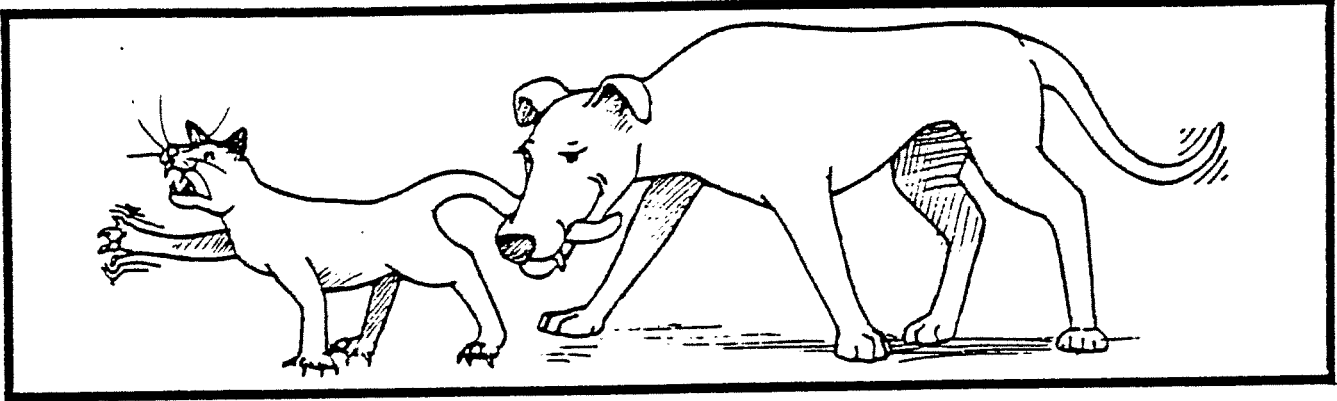

2

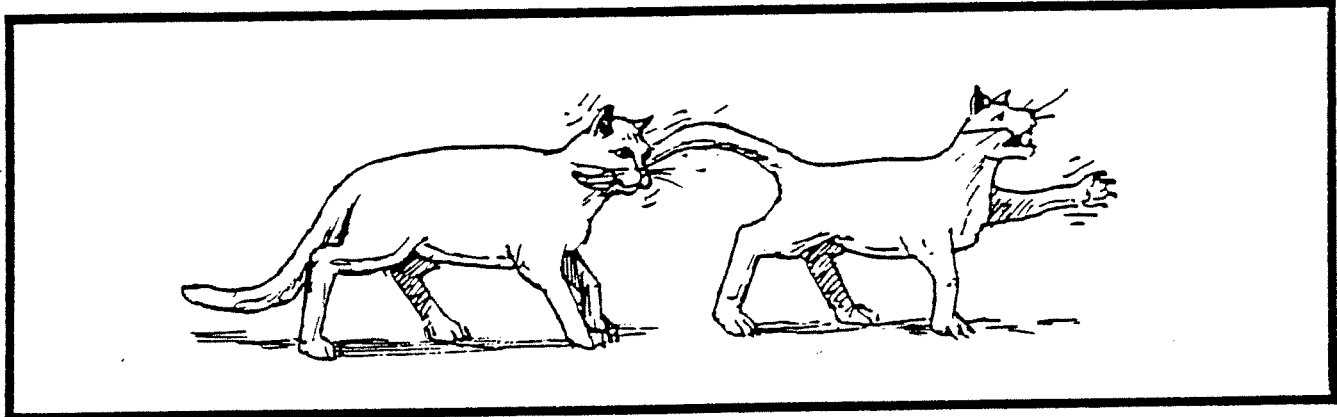

3

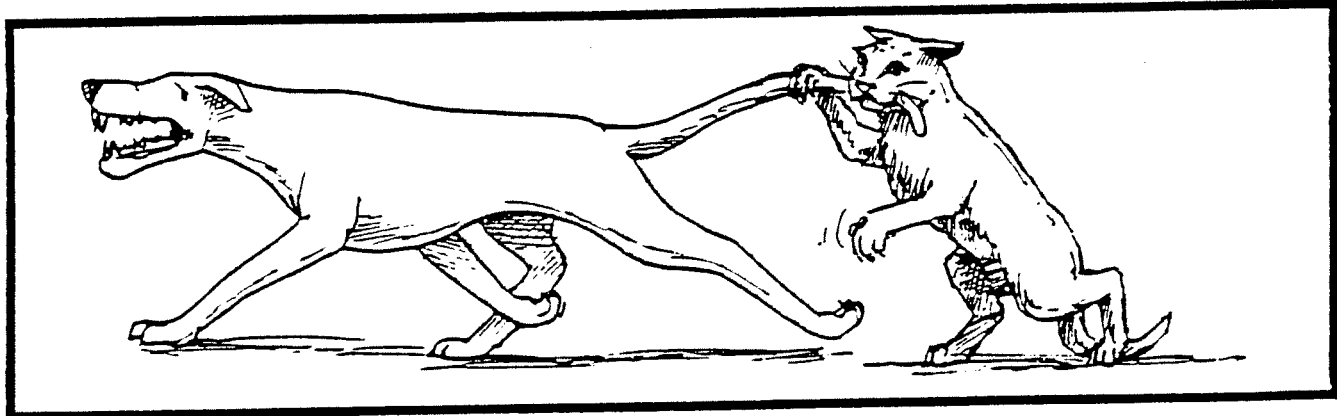

4

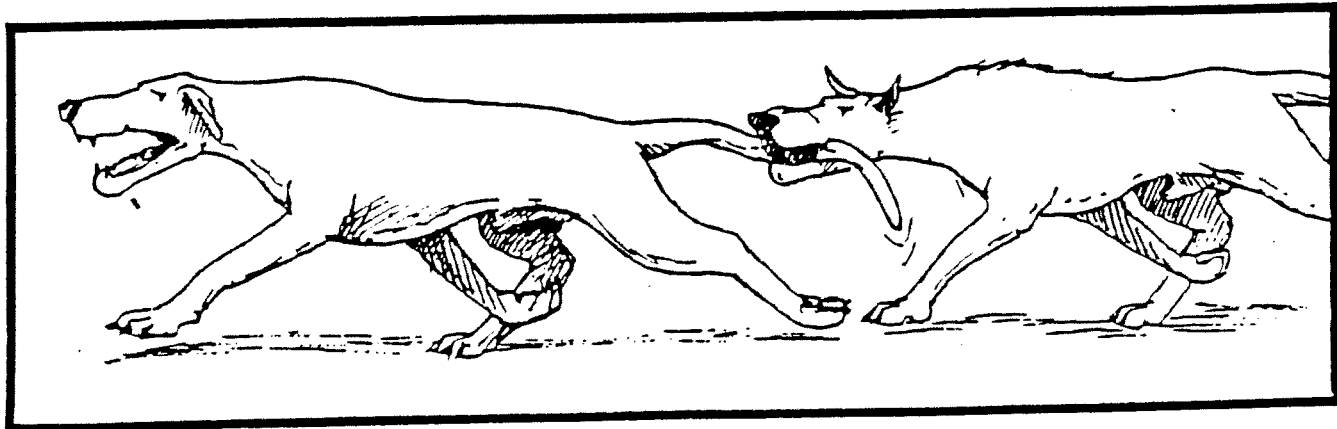

Это грузовик, который тянет автомобиль.

1

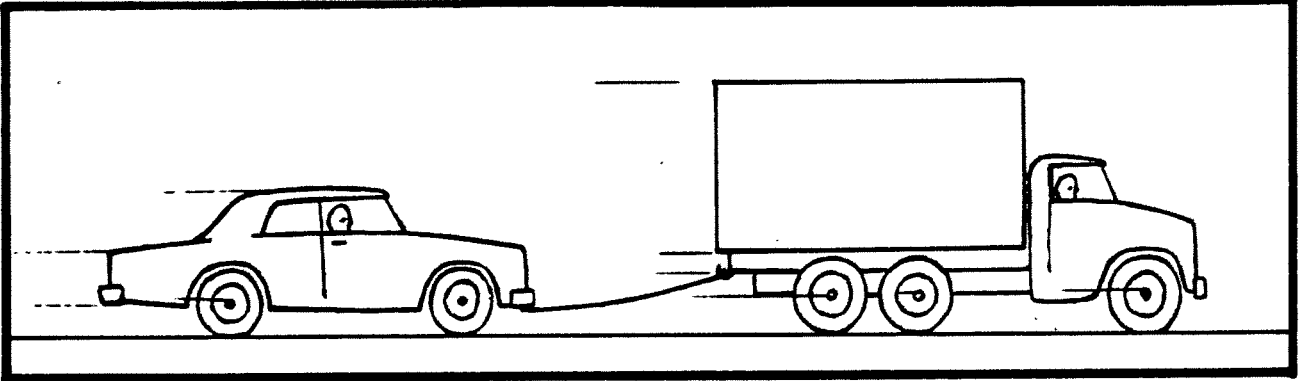

2

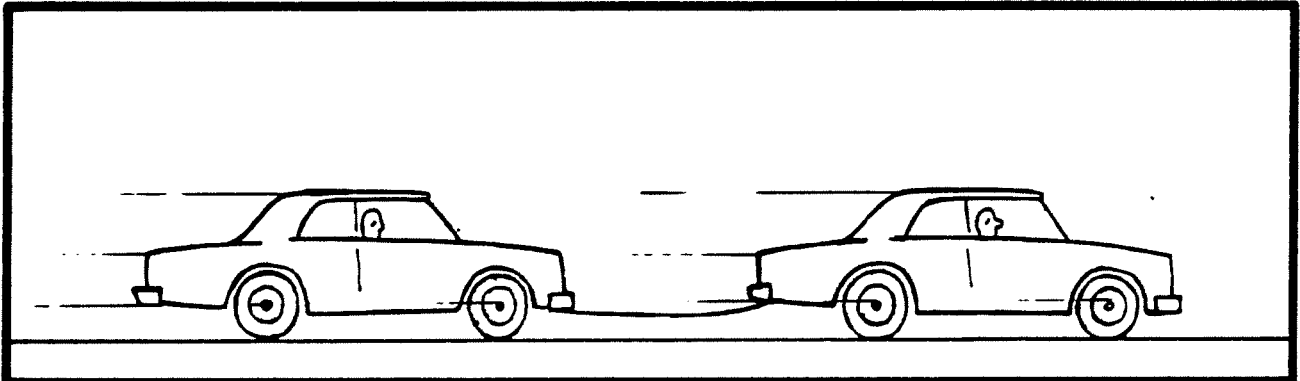

3

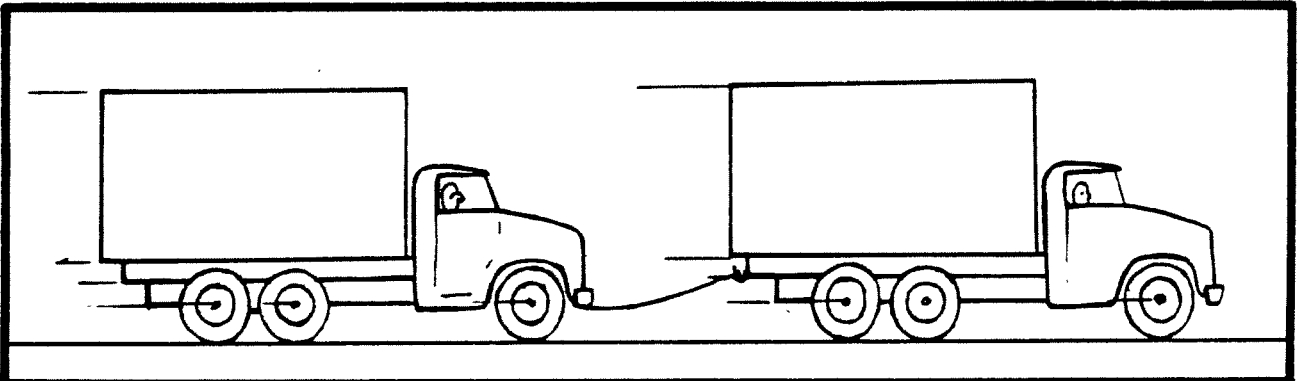

4

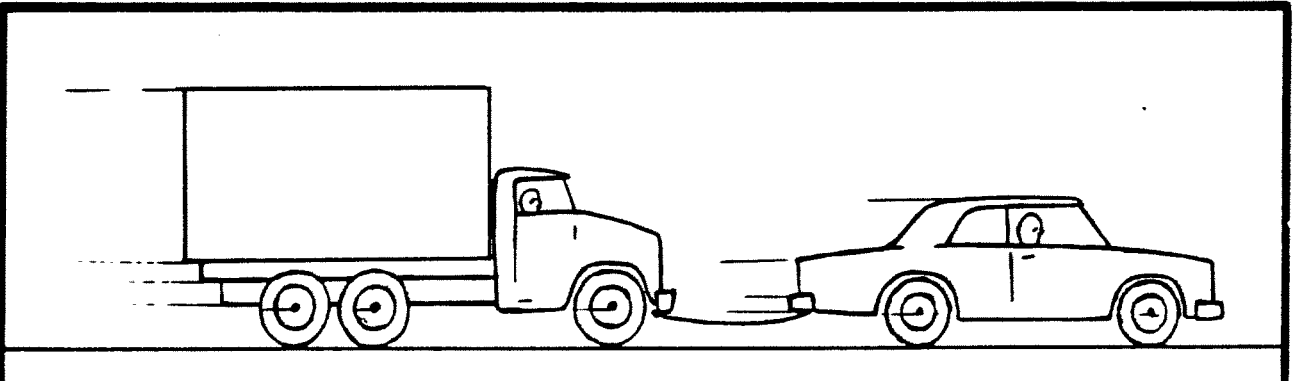

Мальчик не толкает девочку.

1

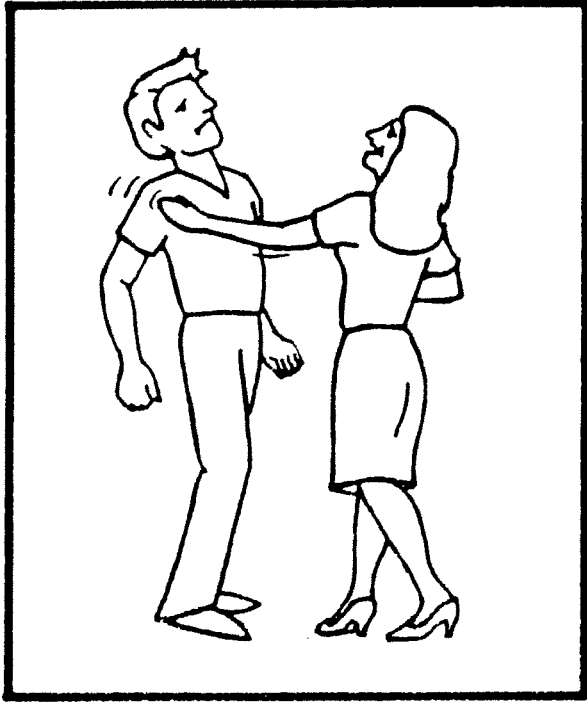

2

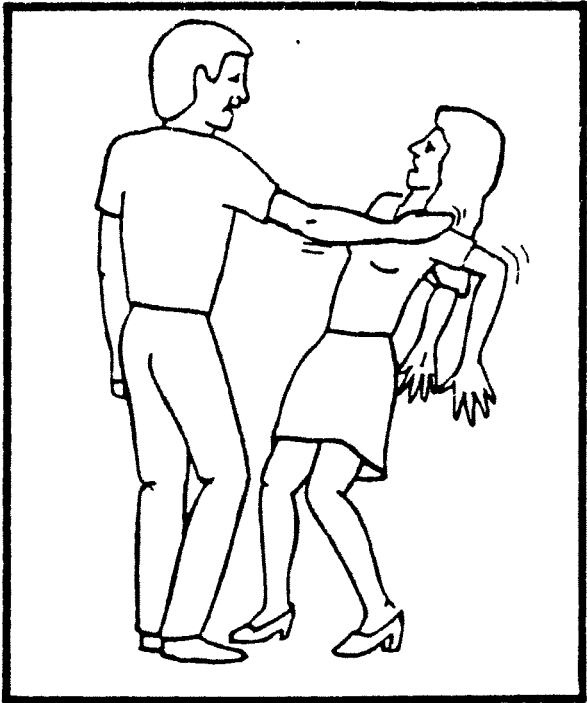

Грузовик не тянется автомобилем.

1

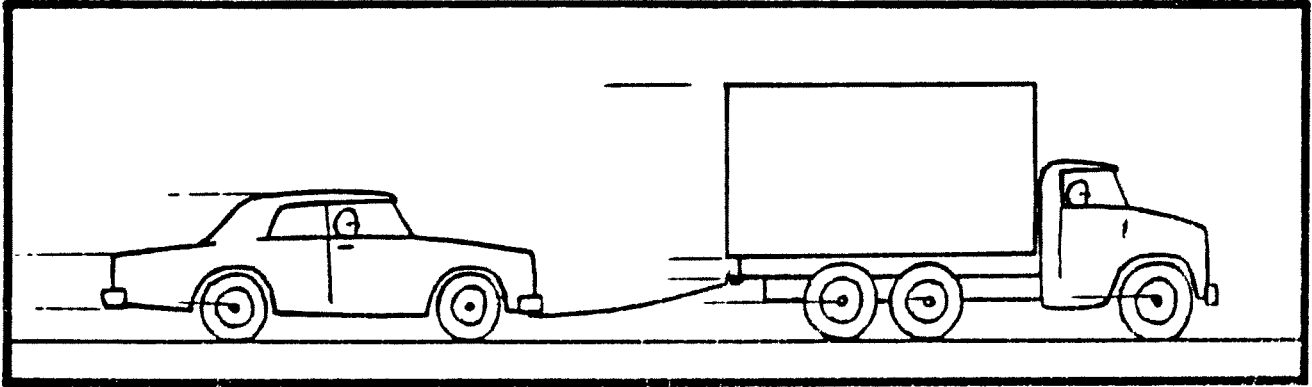

2

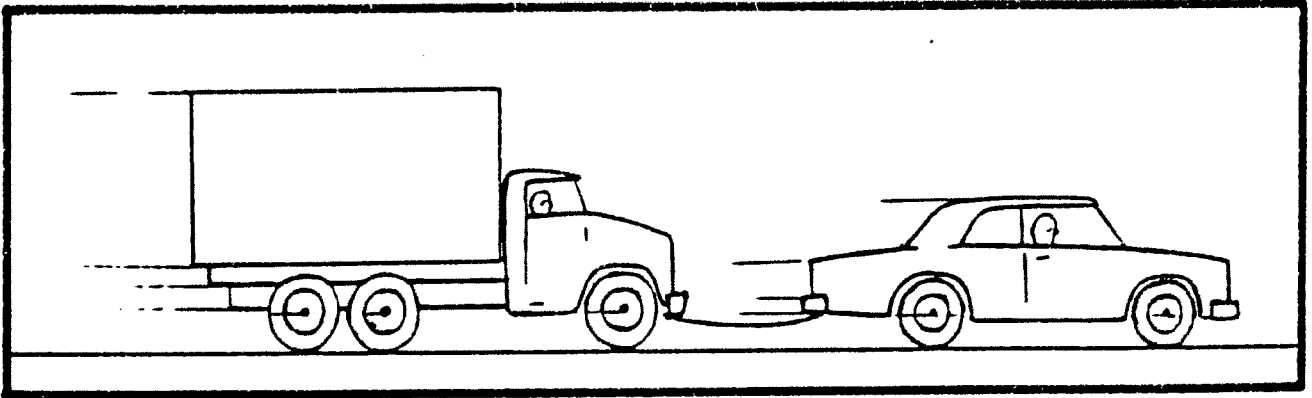

Это собака, которую кошка кусает.

1

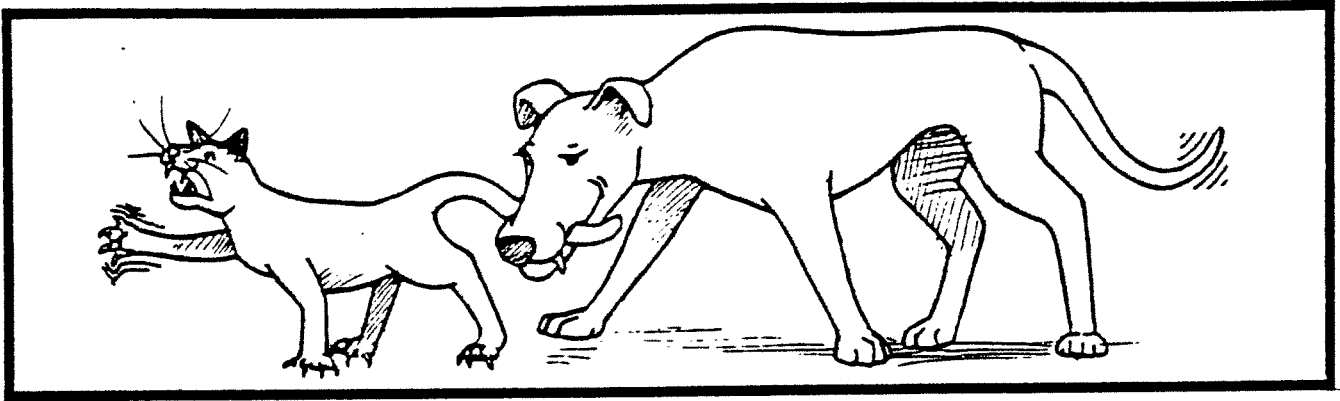

2

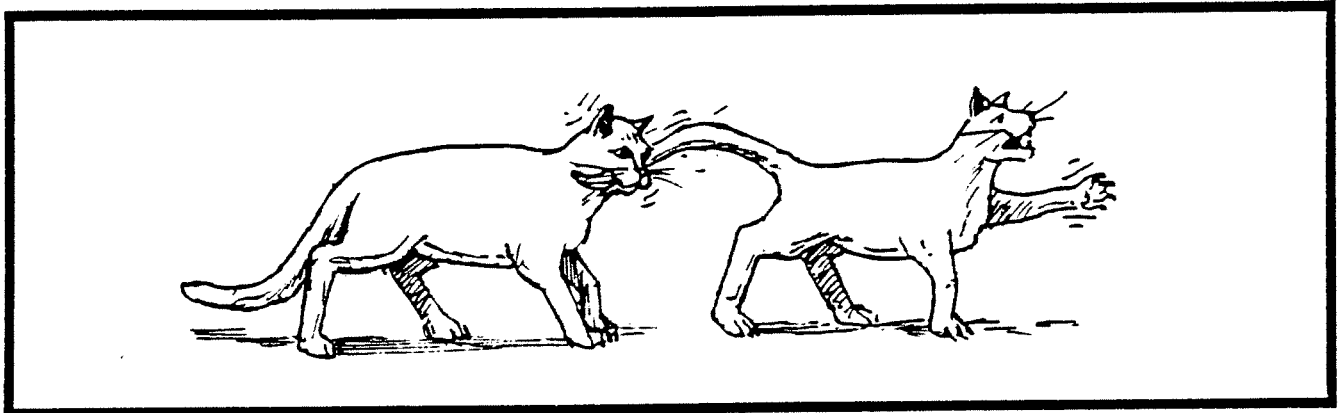

3

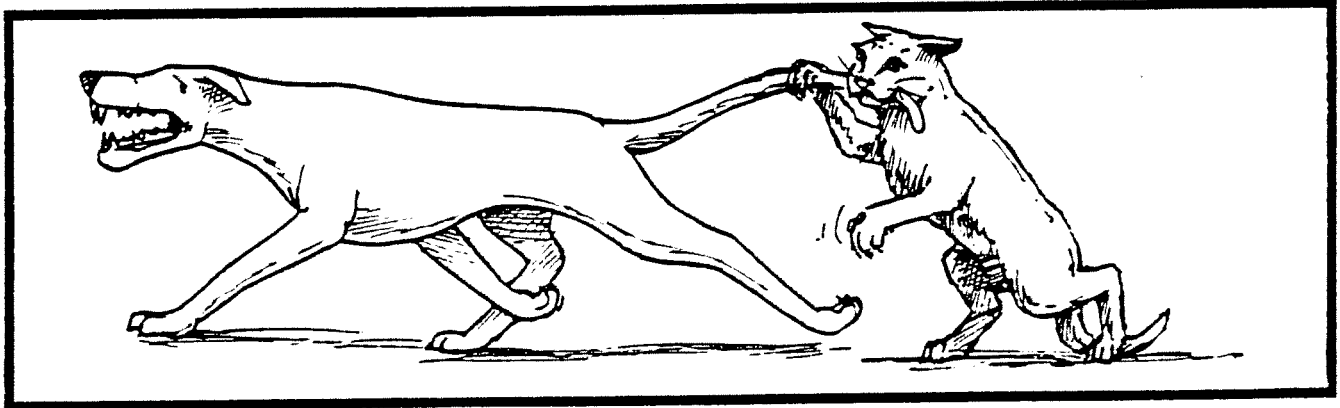

4

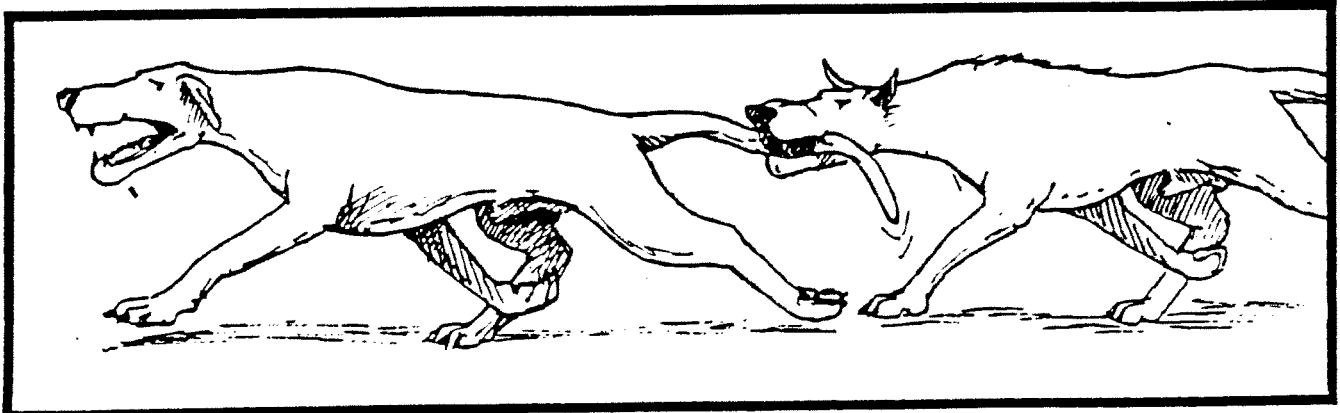

Он держит её.

1

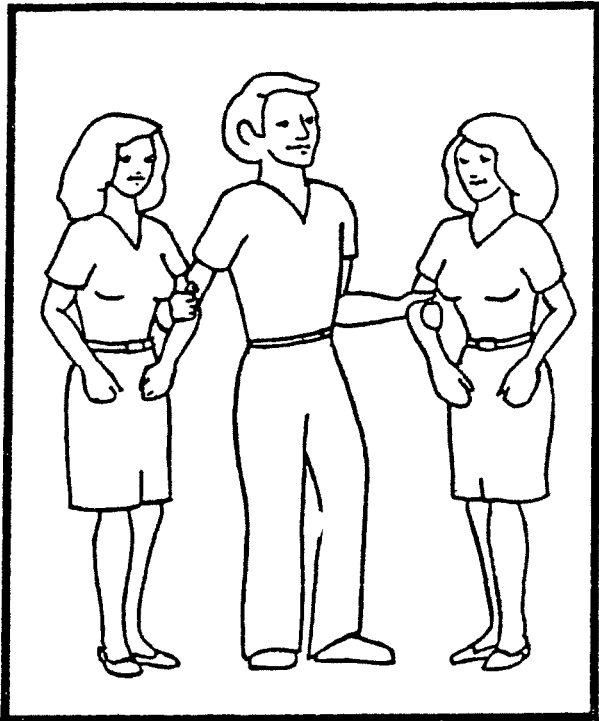

2

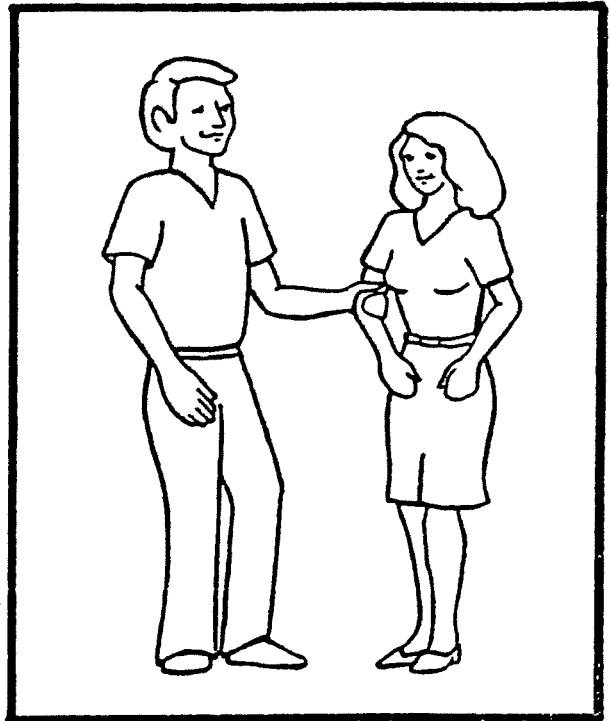

3

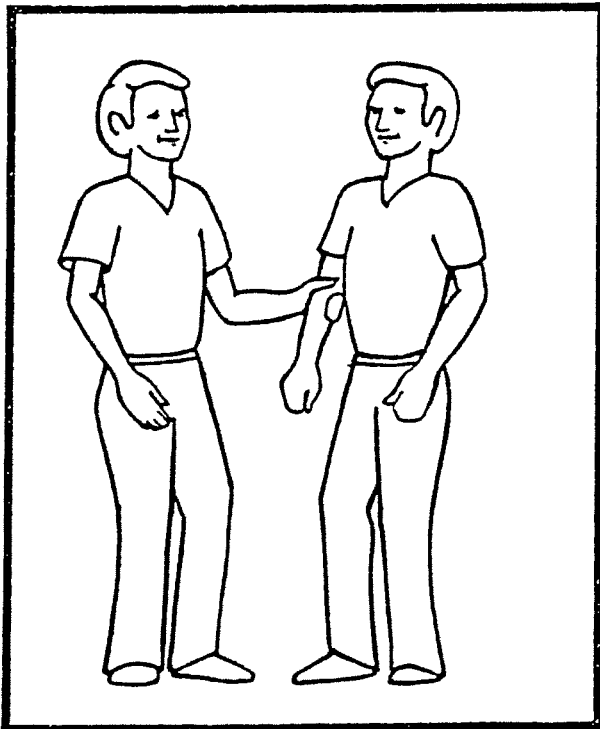

4

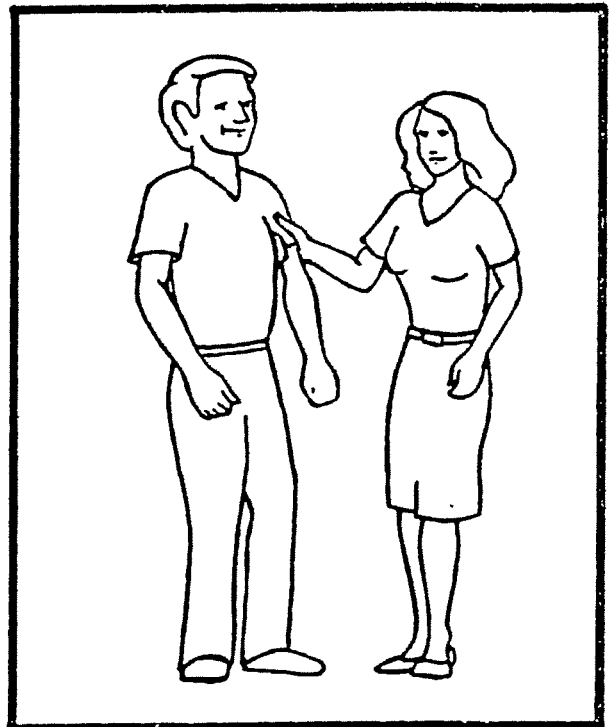

Девочка, которую толкает мальчик.

1

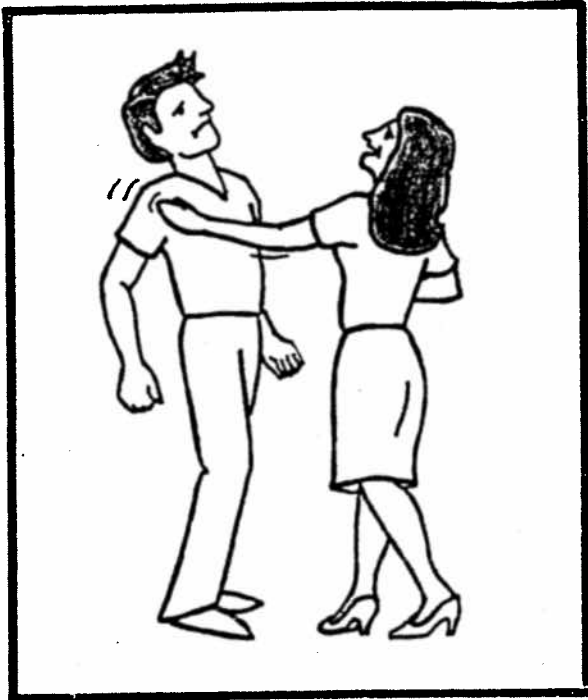

2



3



4

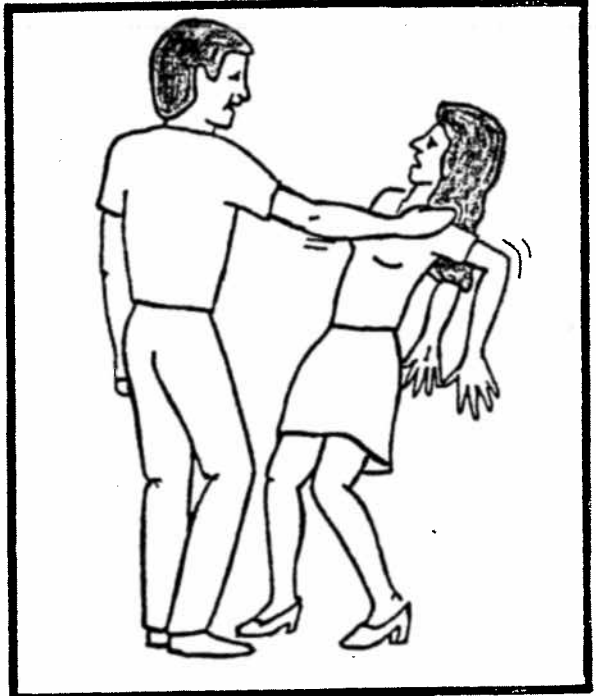

Женщина, которую мужчина не целует.

