

Michel Paradis  
McGill University

**BILINGUAL APHASIA TEST**  
**(RUMANIAN VERSION)**

**STIMULUS BOOK**

Versiune în limba română

The development of the Bilingual Aphasia Test materials was supported by Grant MEQ 01-07-k (1976-1983) from the Quebec Ministry of Intergovernmental Affairs, Grant EQ 1660 (1980-1985) from the Quebec Ministry of Education FCAC Fund, and Grants 410-83-1028 (1984, 1985) and 410-88-0821 (1989-1991) from the Social Sciences and Humanities Research Council of Canada.

## DISCRIMINARE AUDITIVĂ VERBALĂ

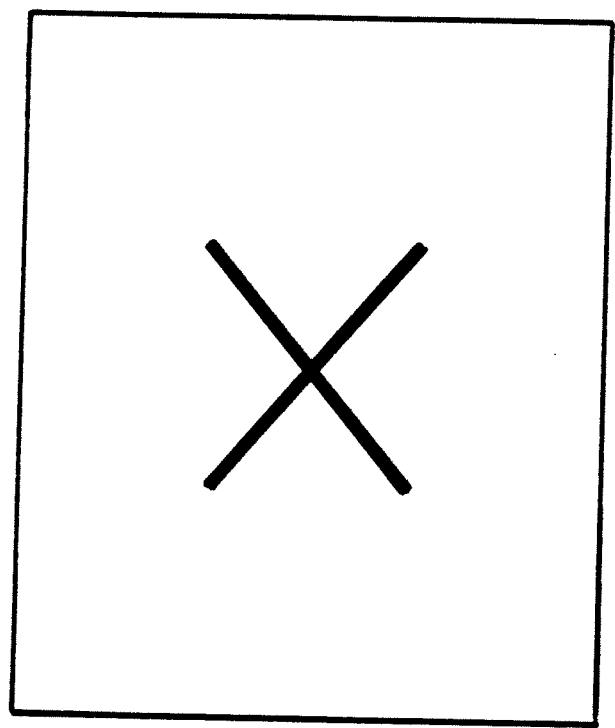

1

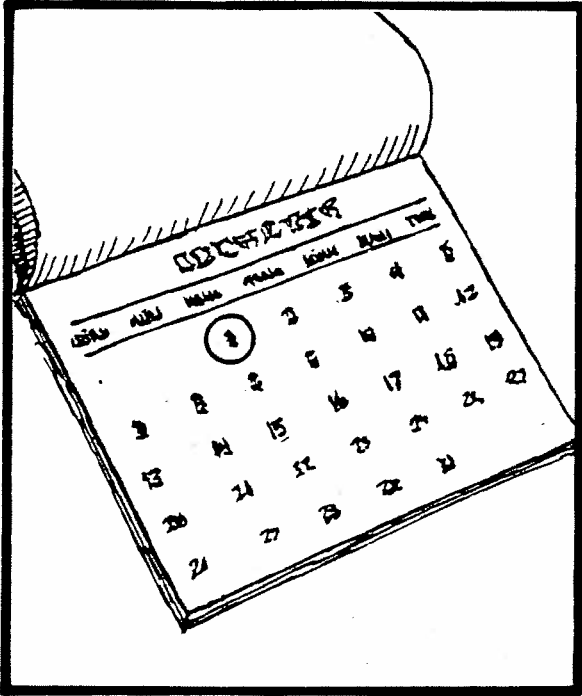

2

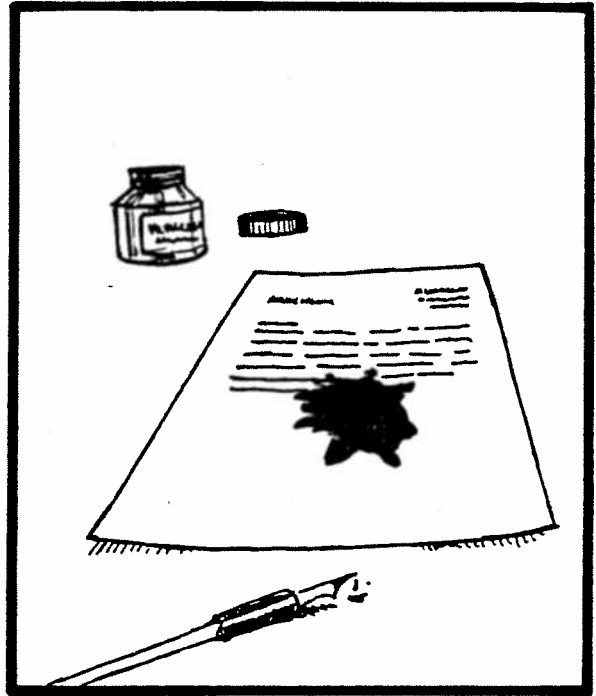

3

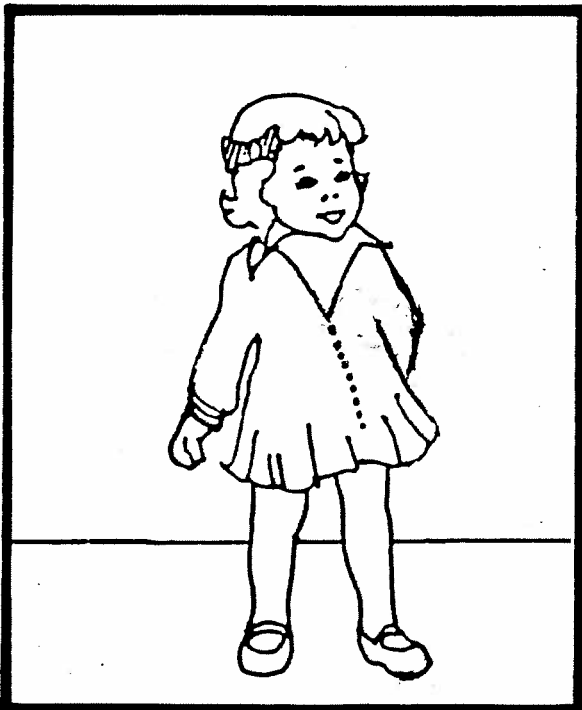

4

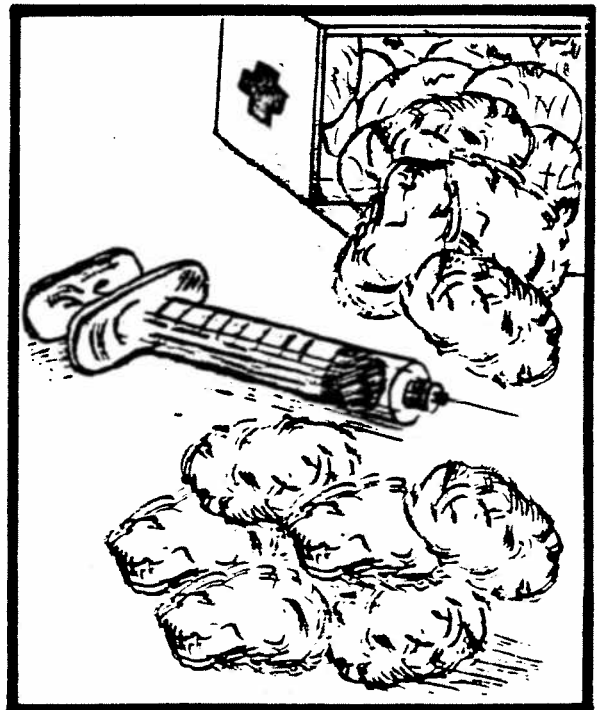

Exemplu

1

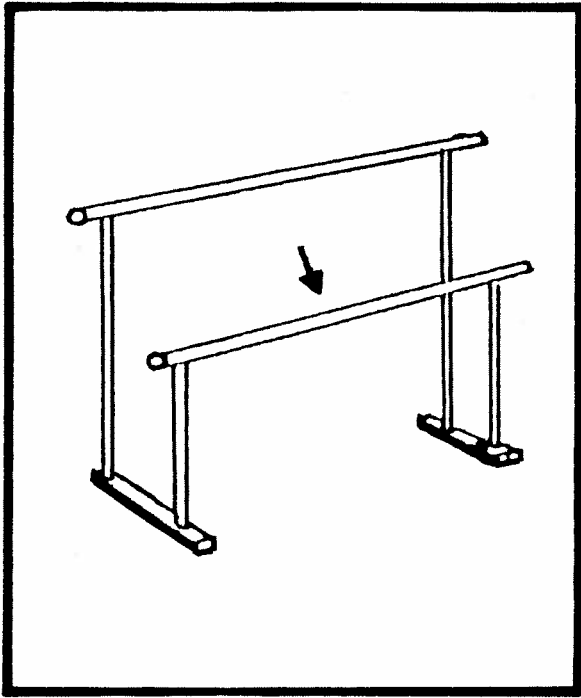

2

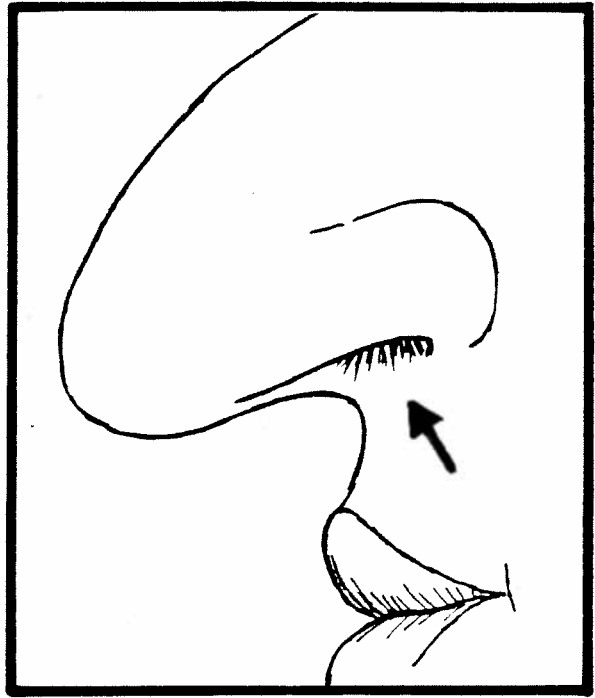

3



4

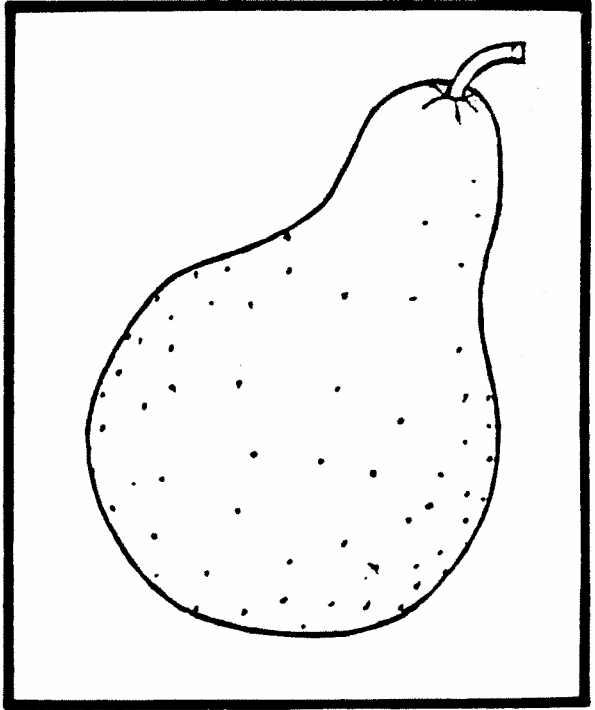

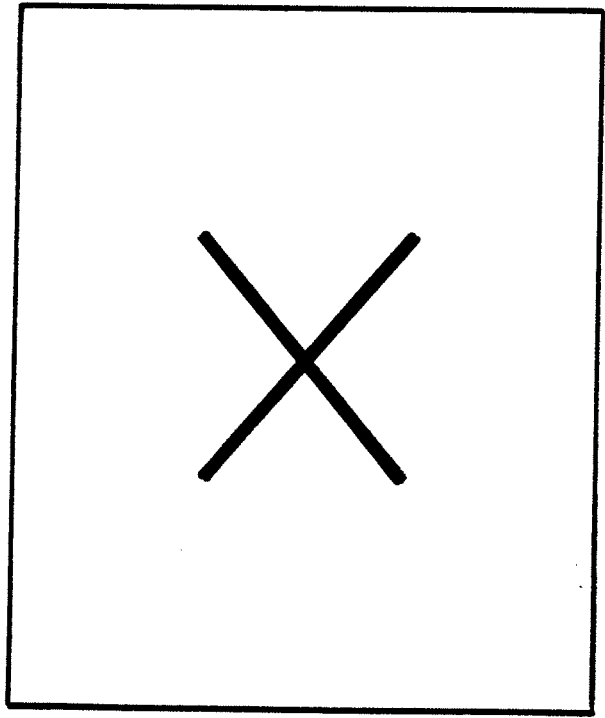

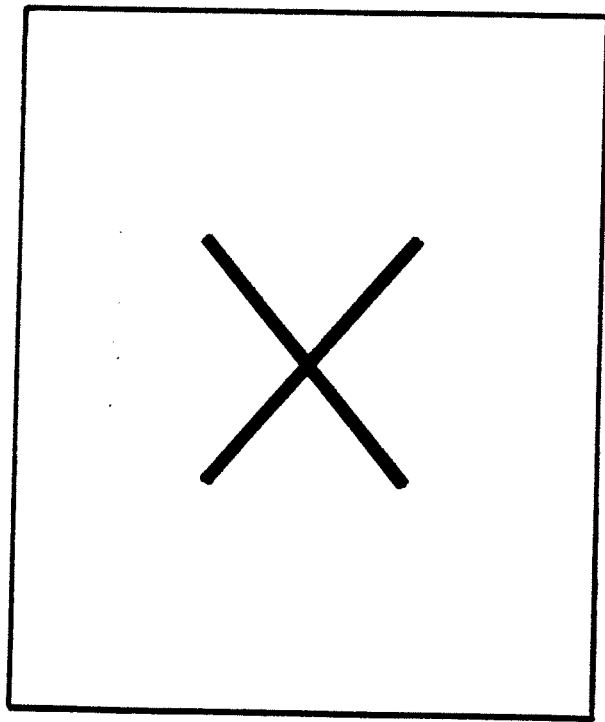



1

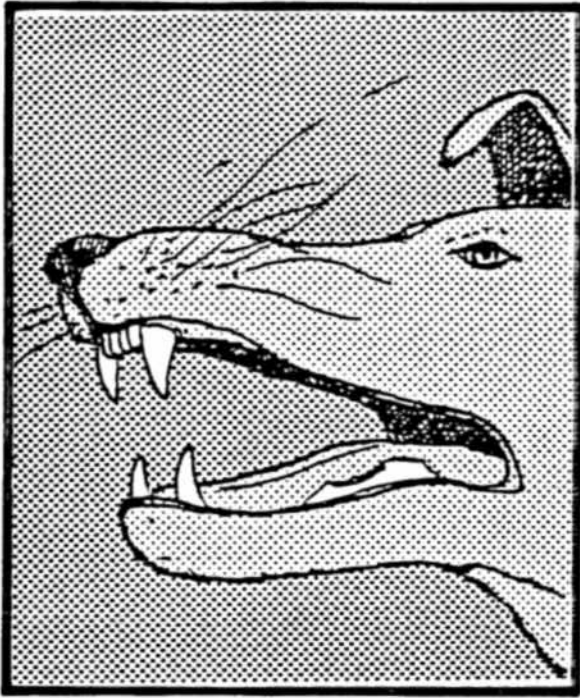

2

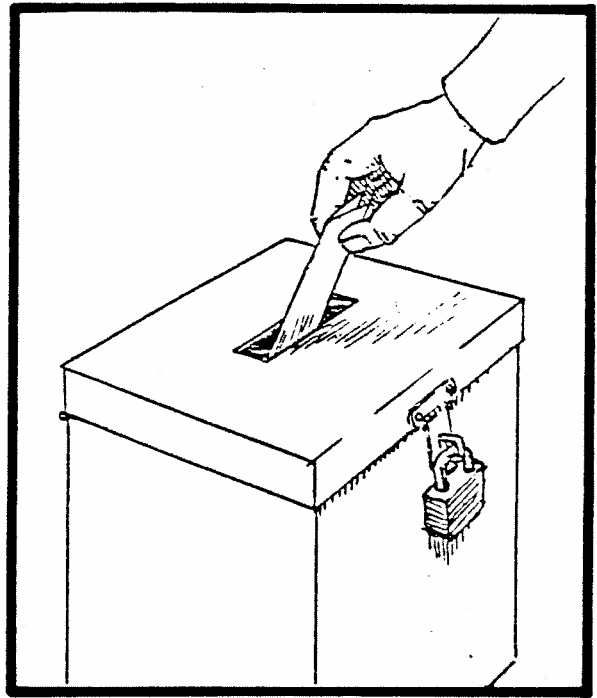

3

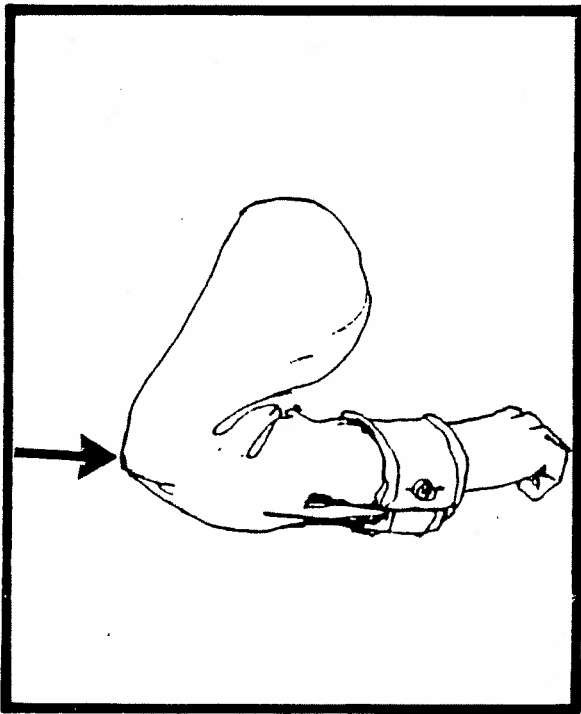

4

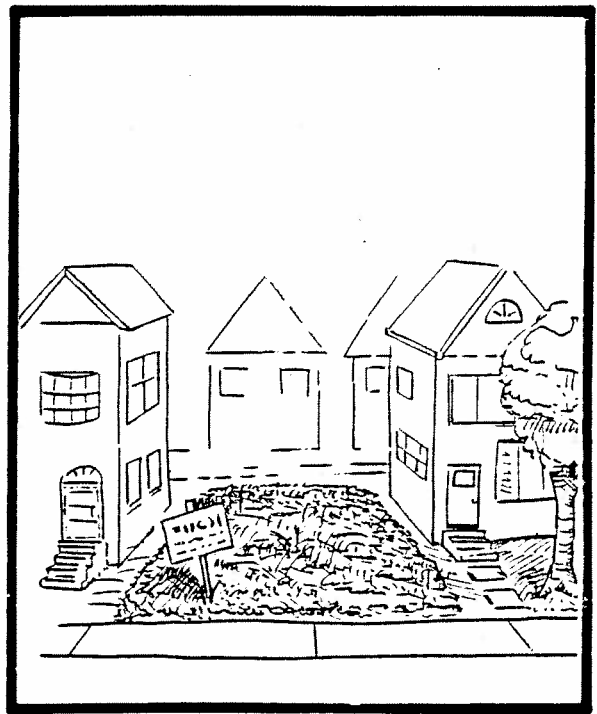

1

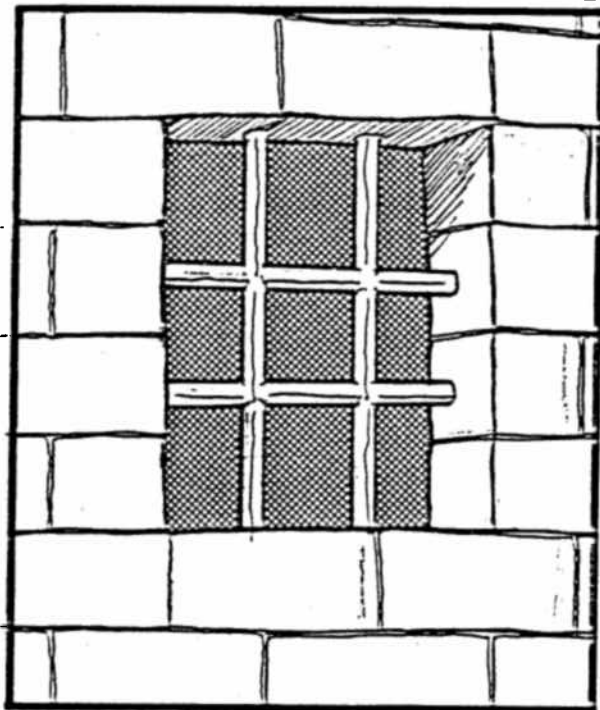

2

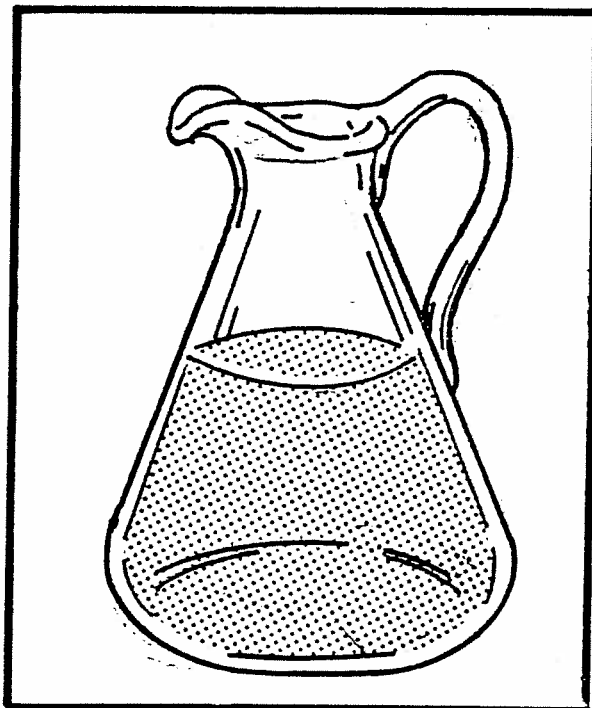

3

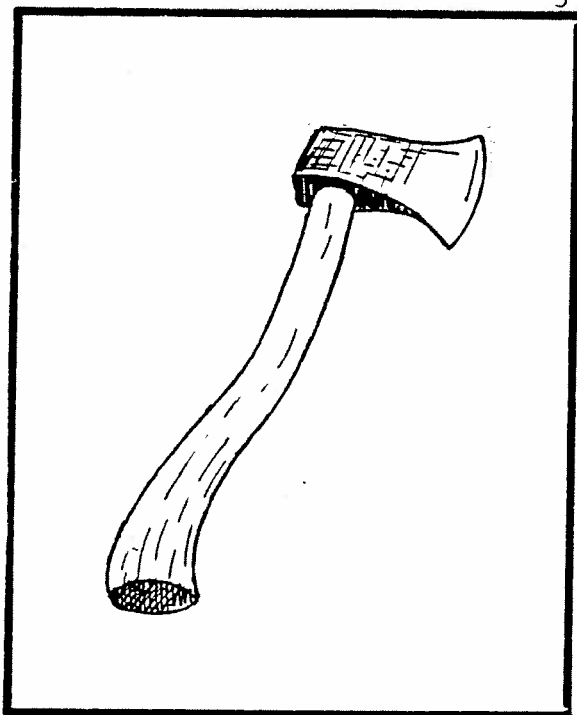

4

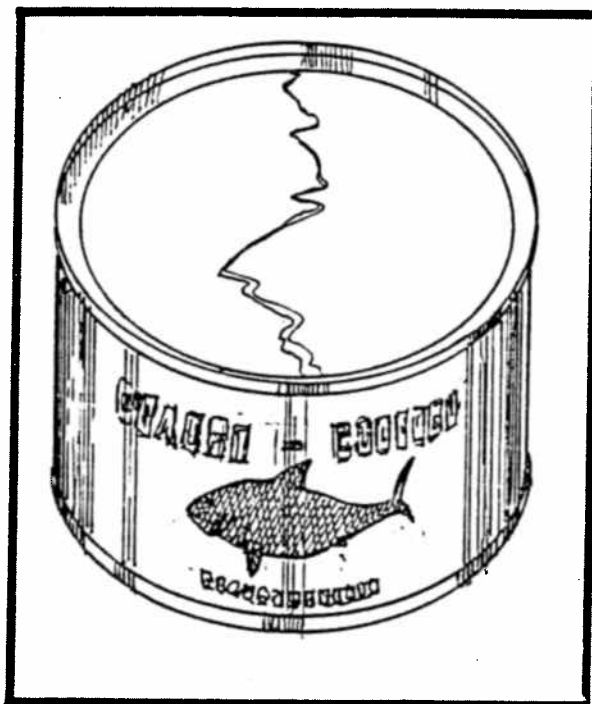

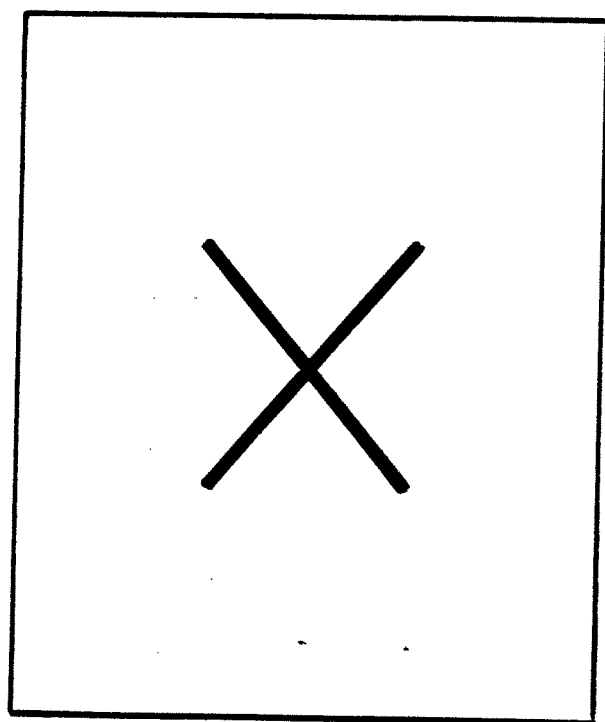

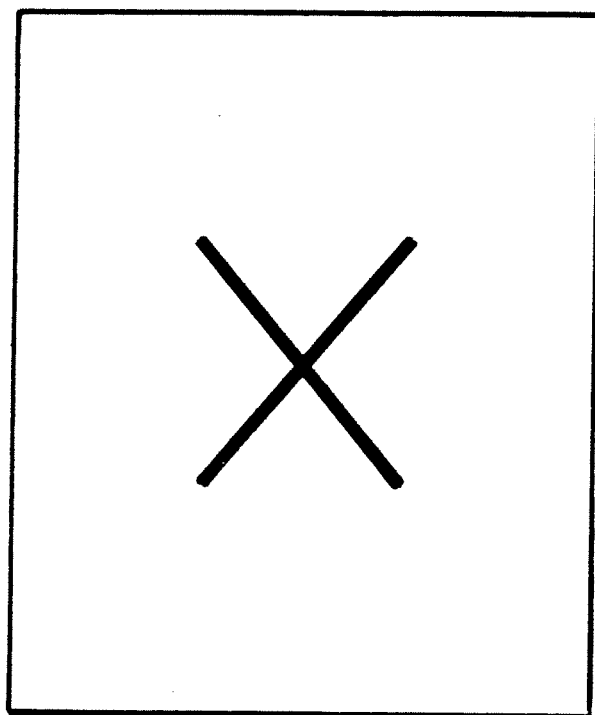

1

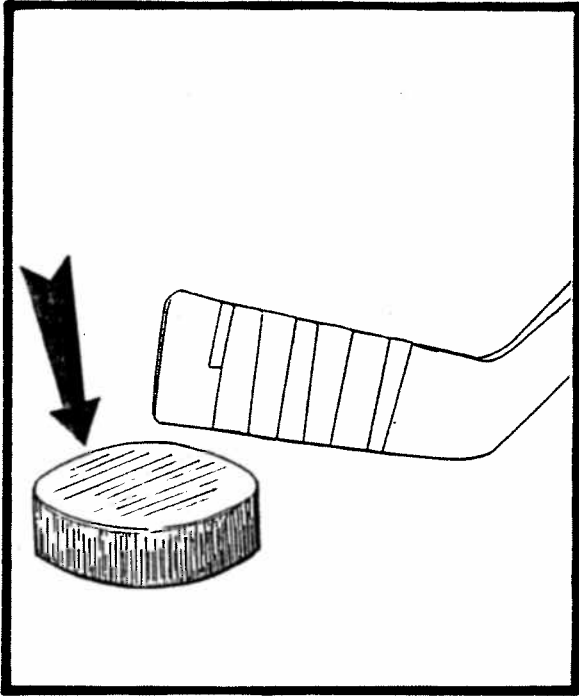

2

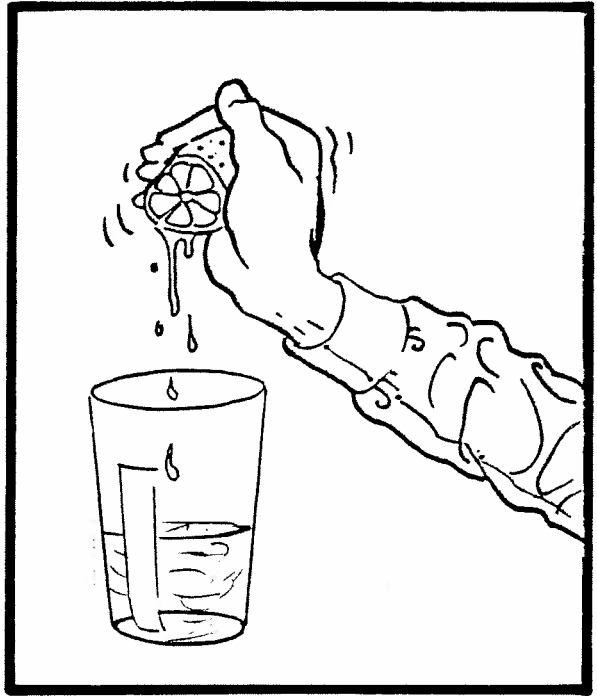

3

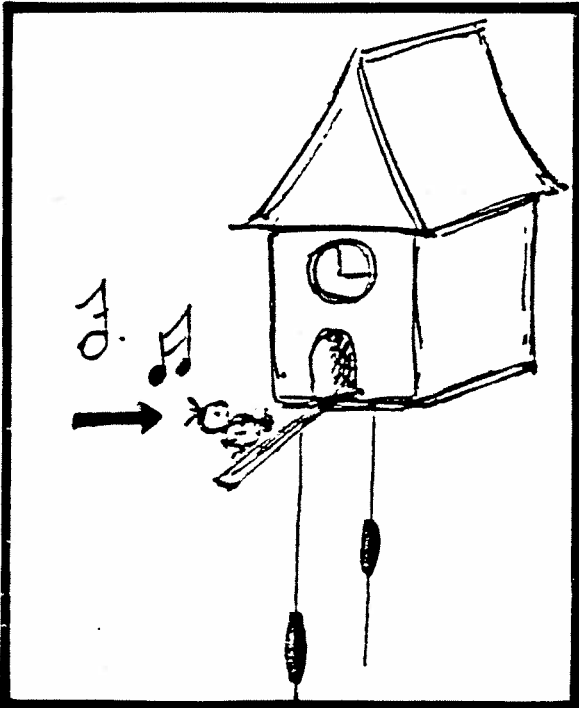

4

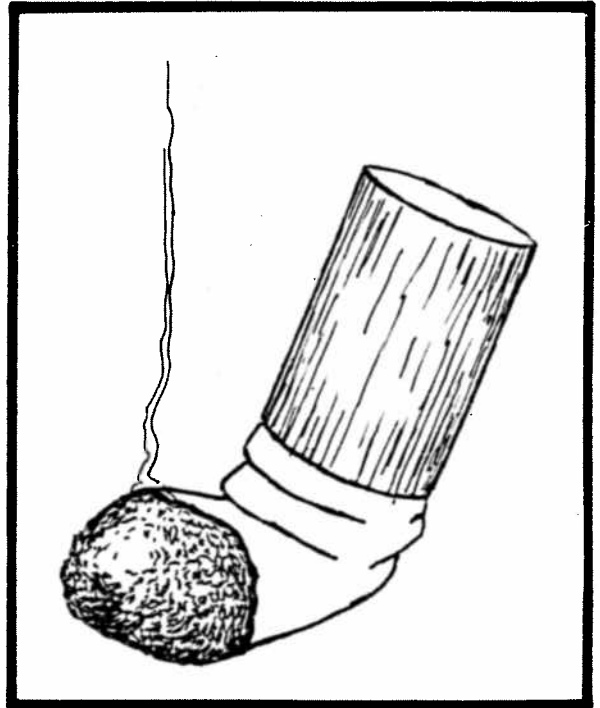

1

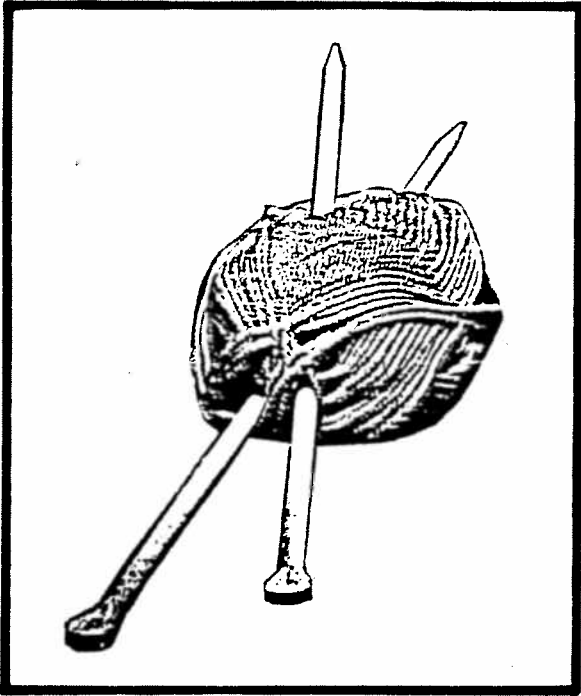

2

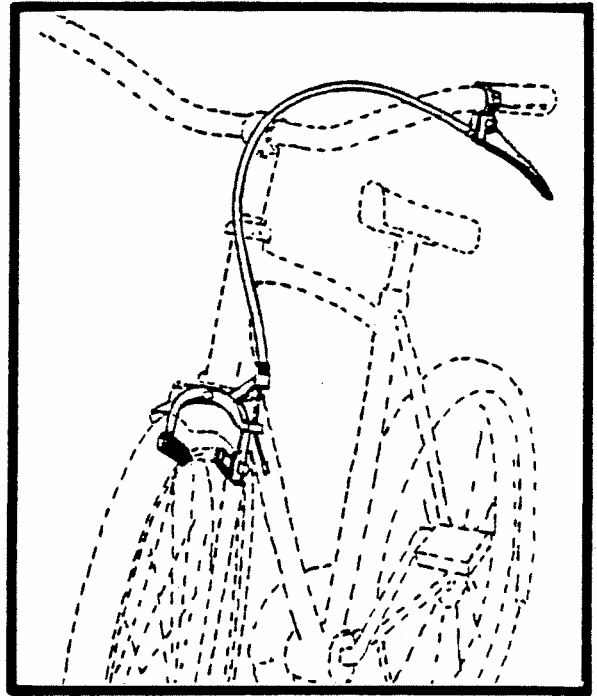

3

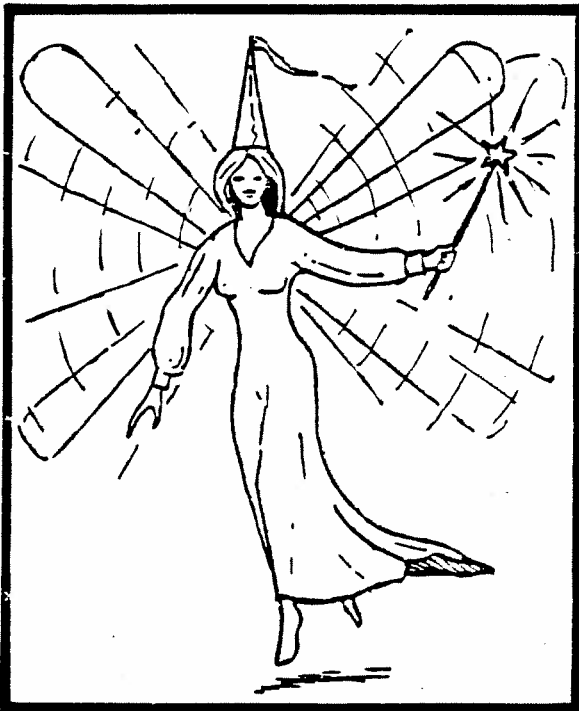

4

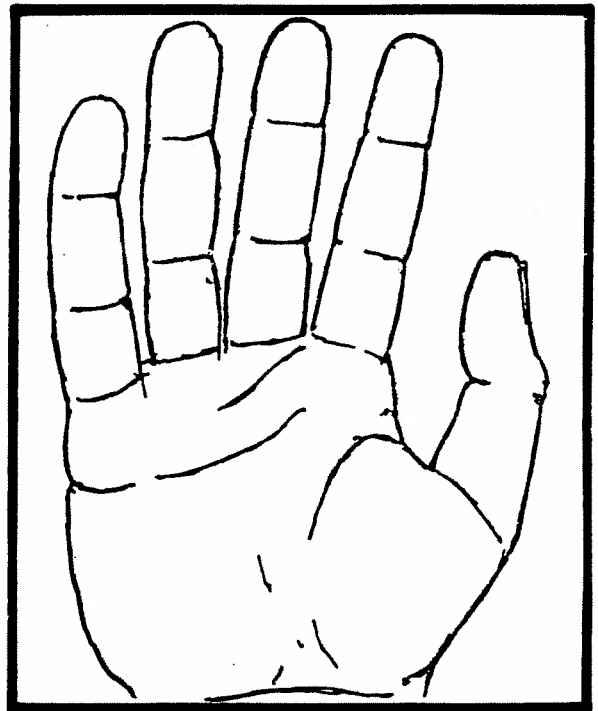

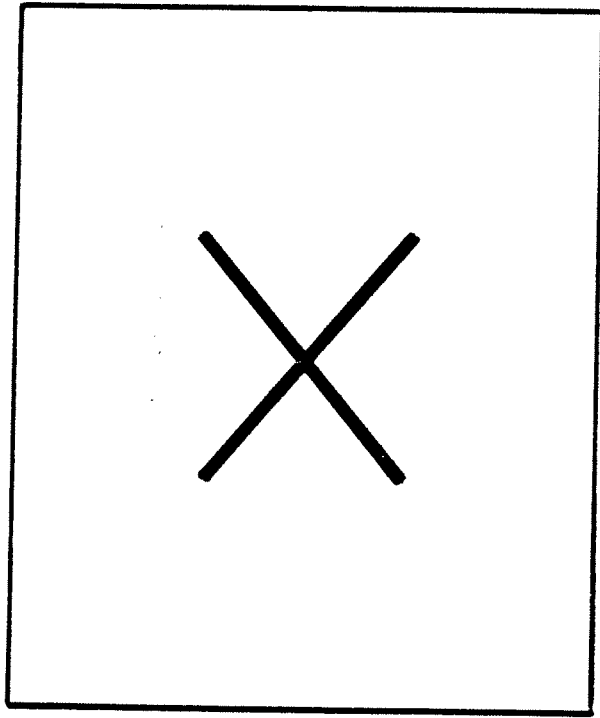

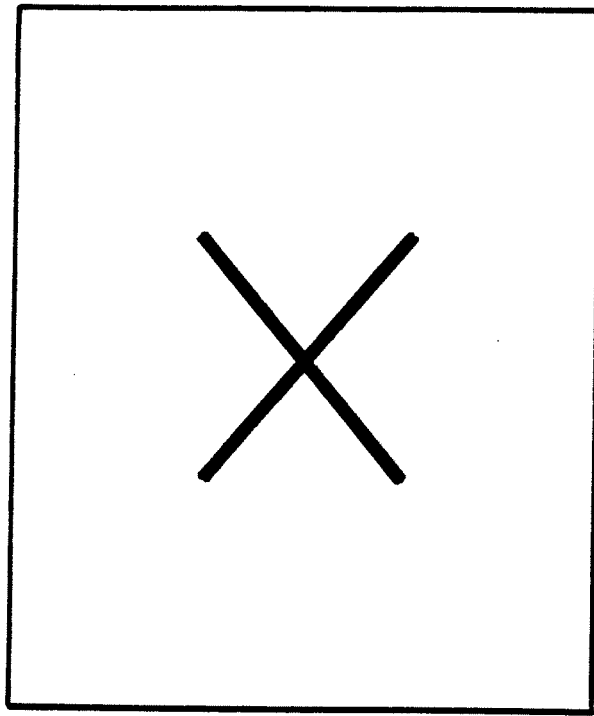



1

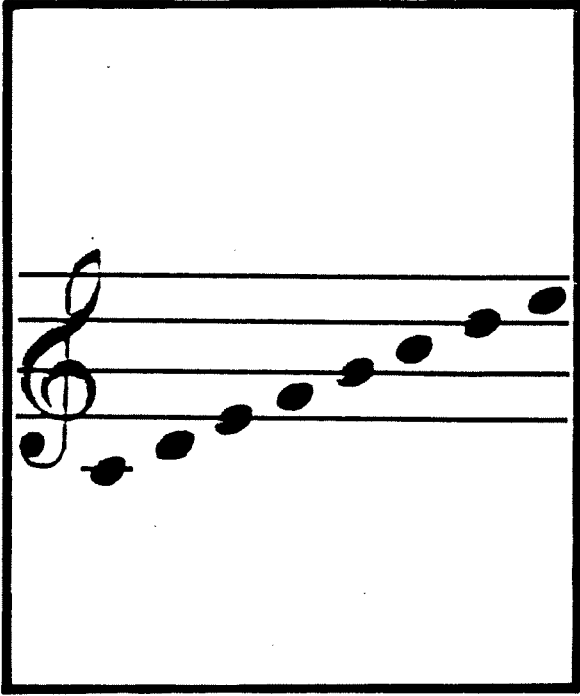

2

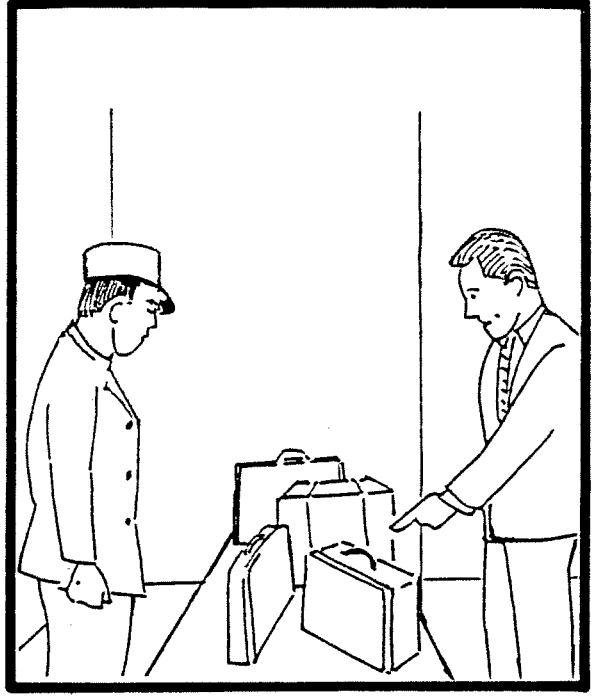

3

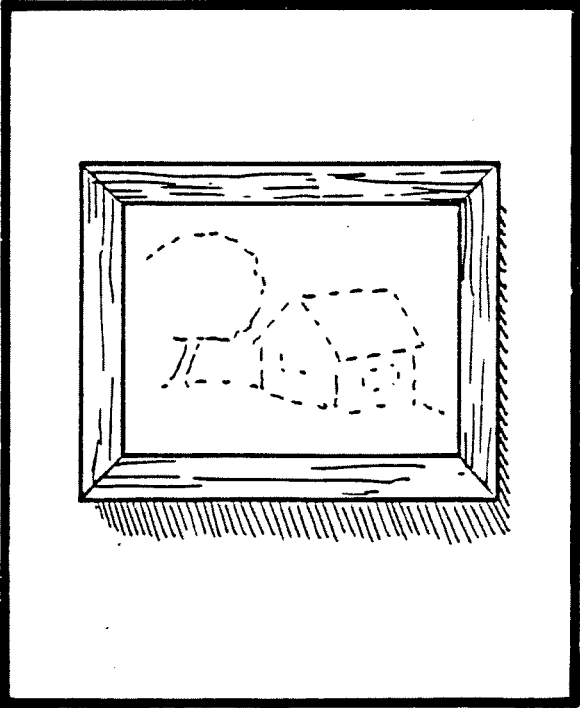

4

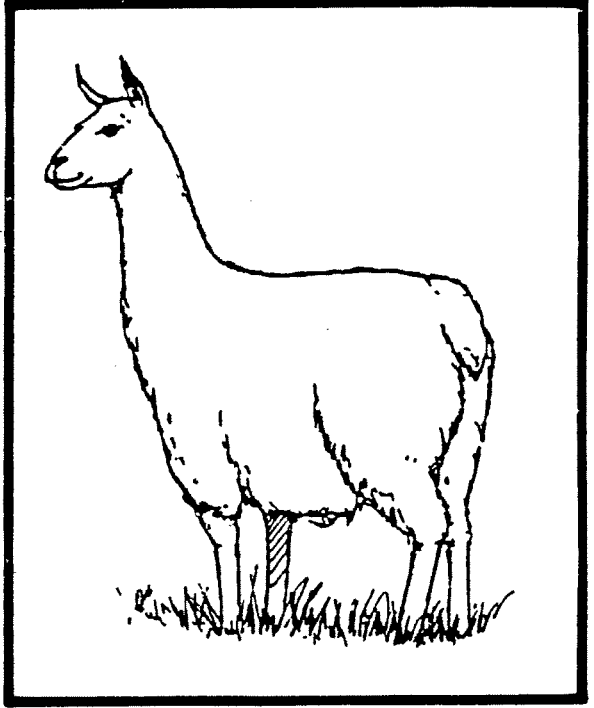

1

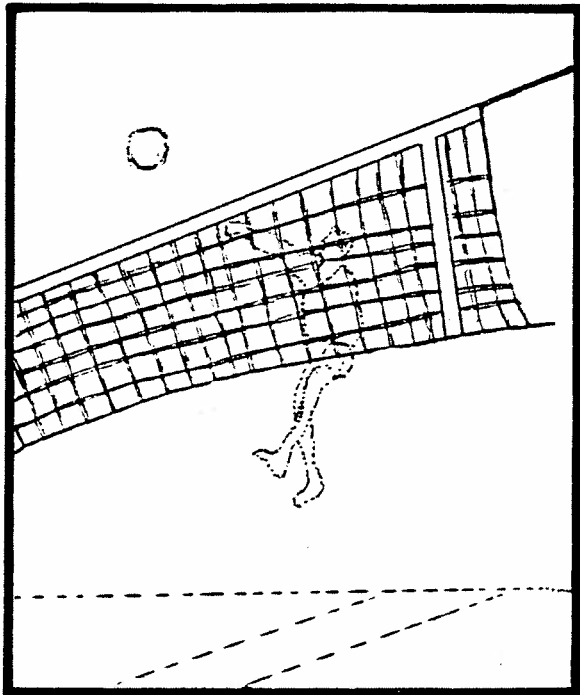

2



3

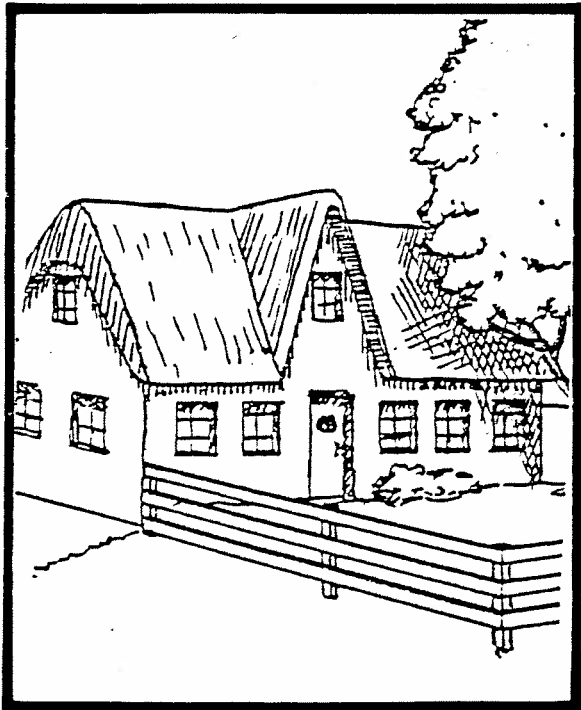

4

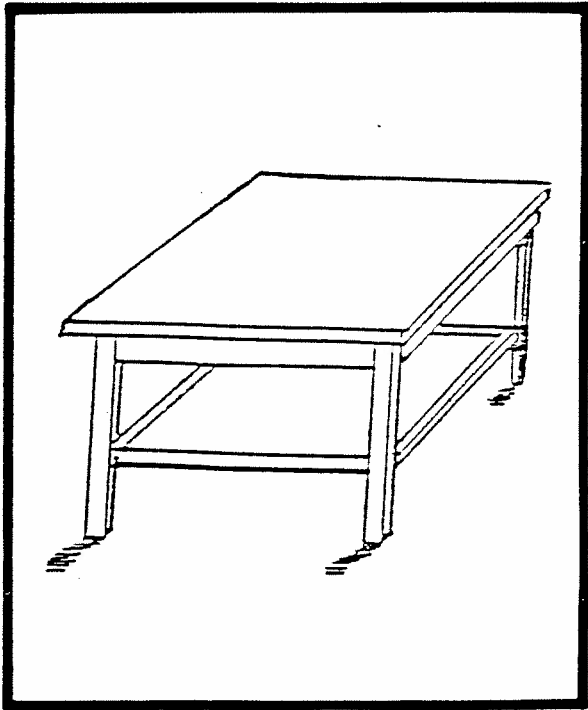

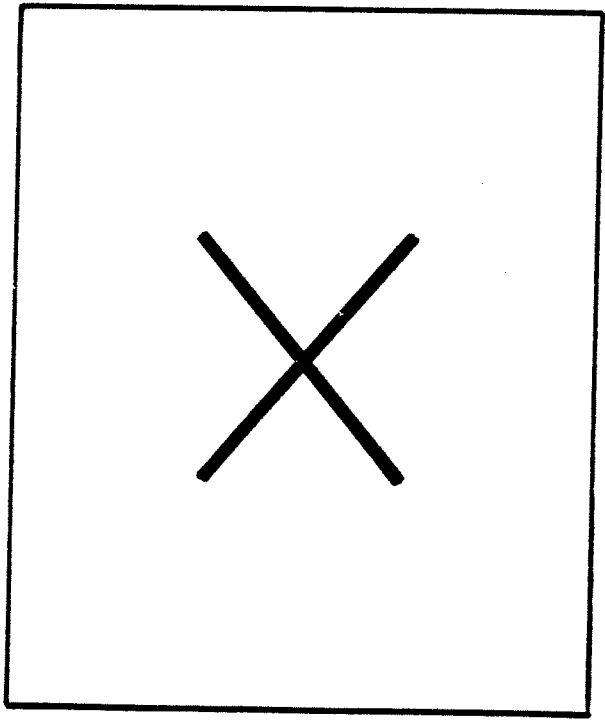

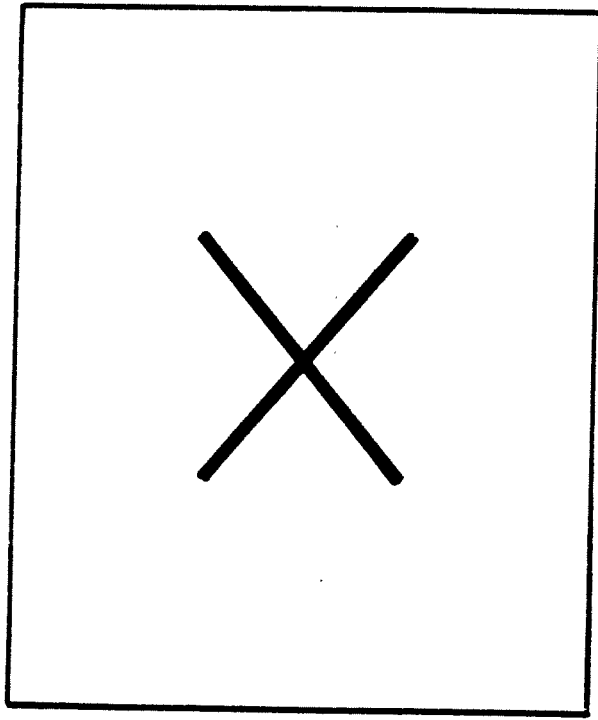

1

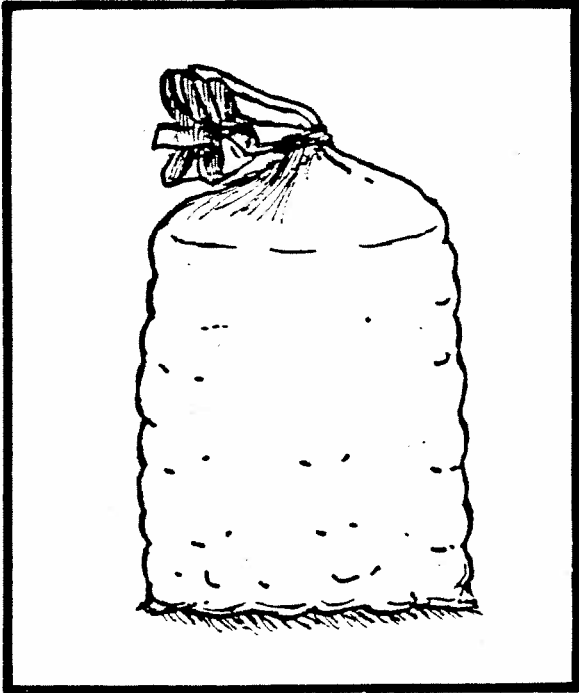

2

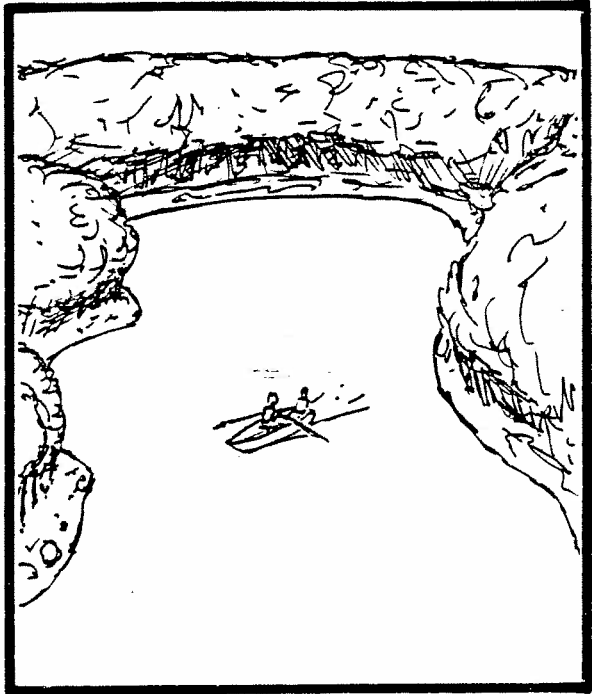

3

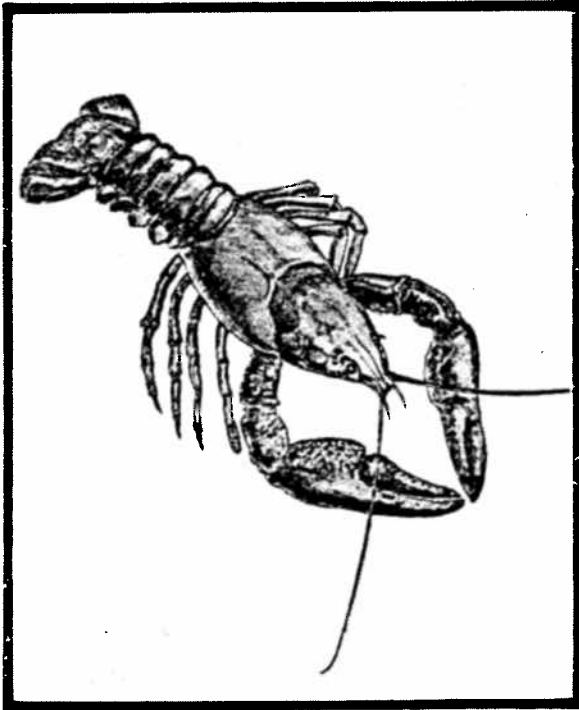

4



1

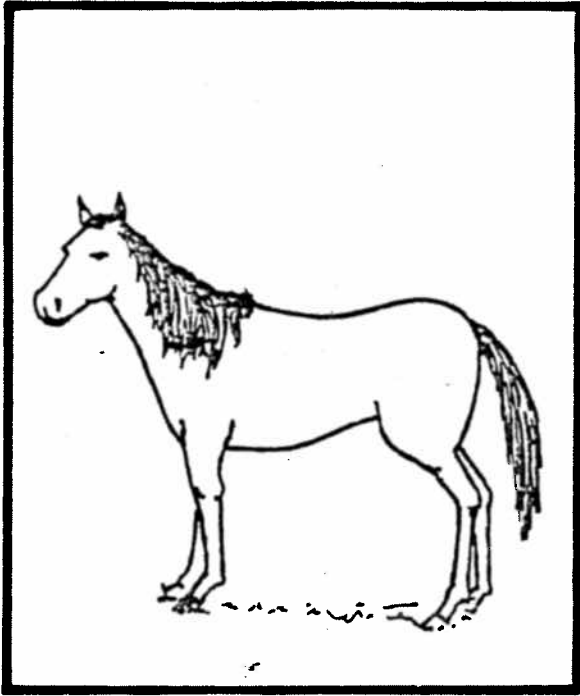

2



3

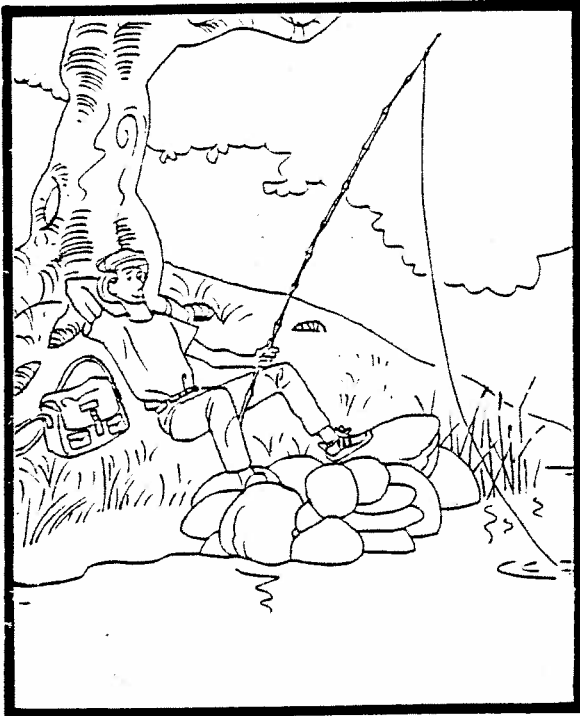

4

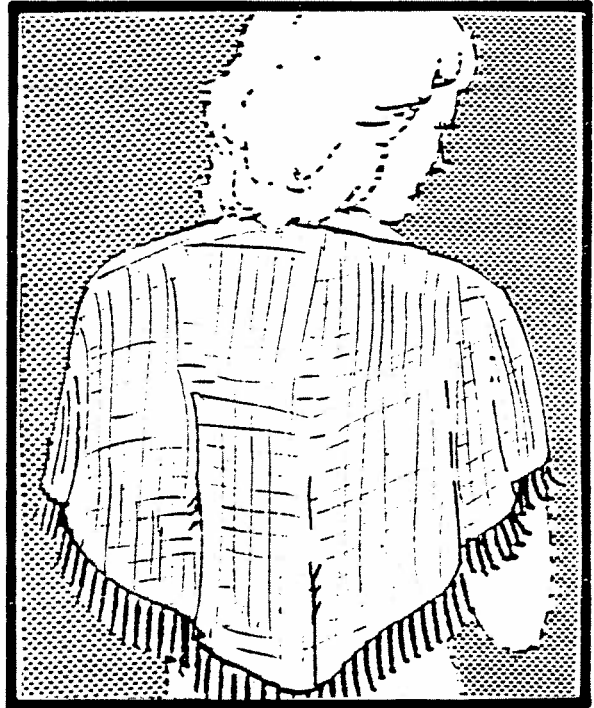

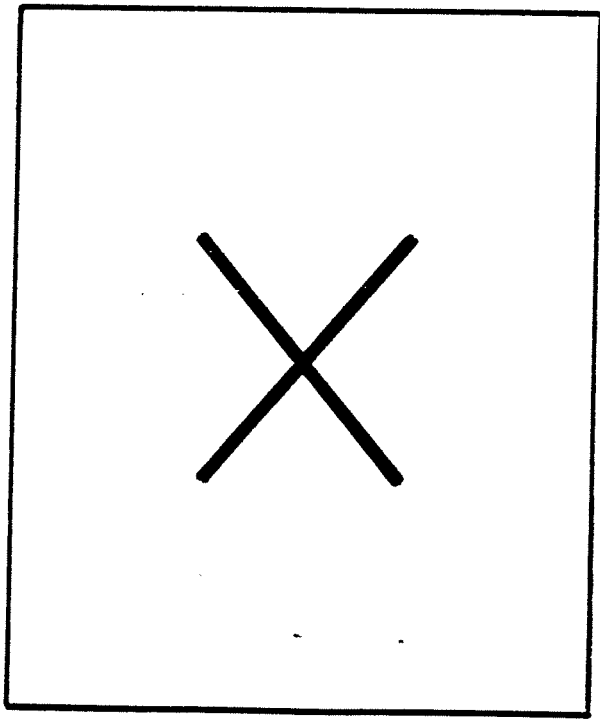

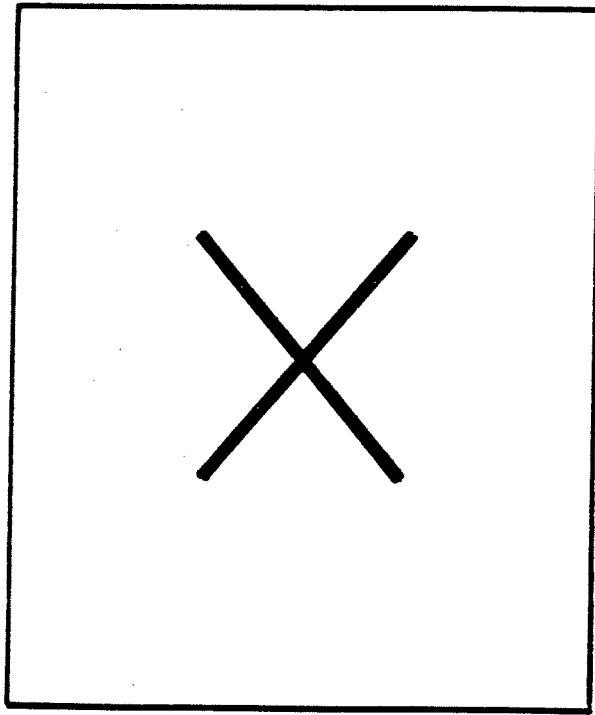



1

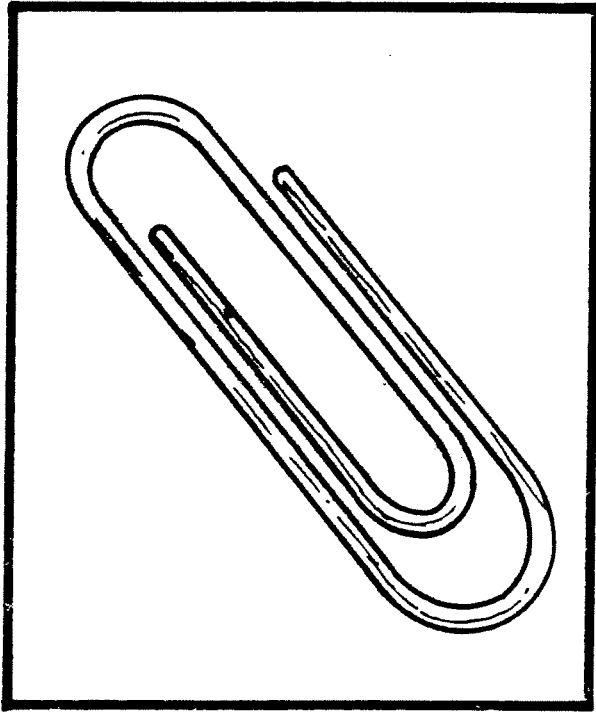

2

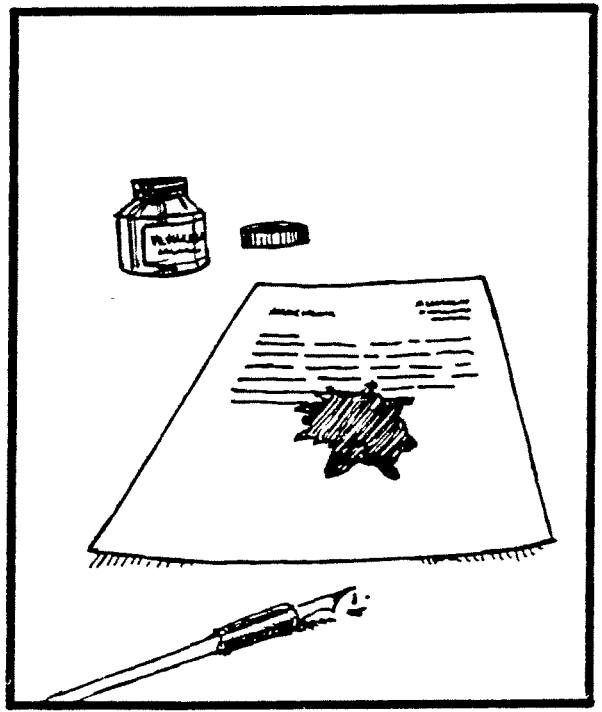

3

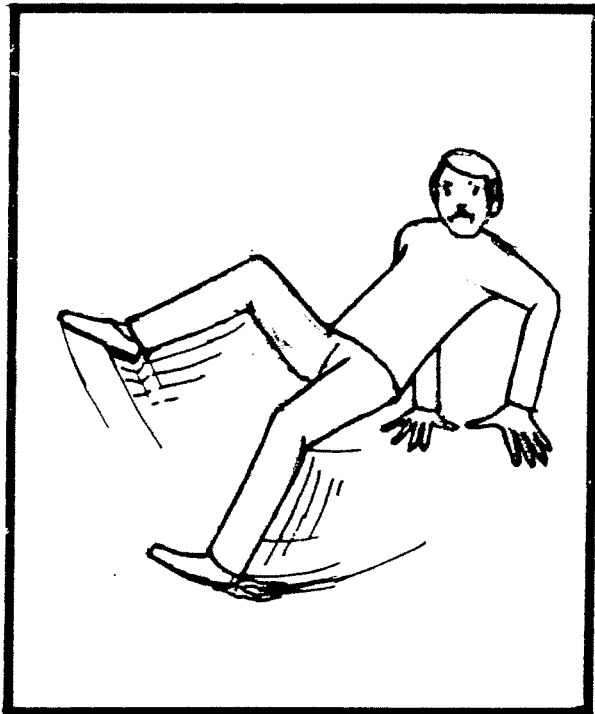

4

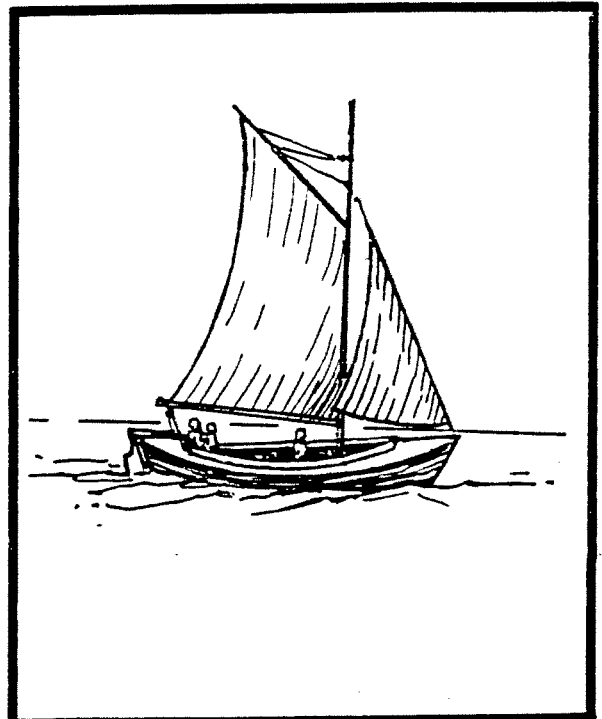

1



2

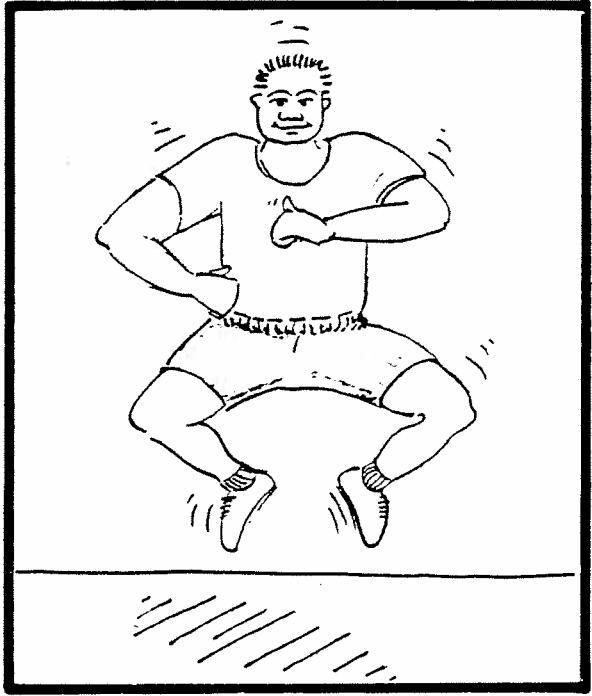

3

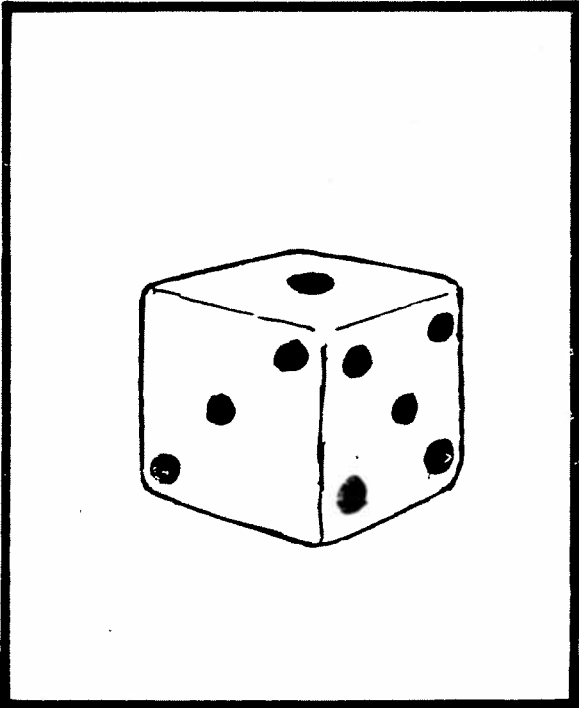

4

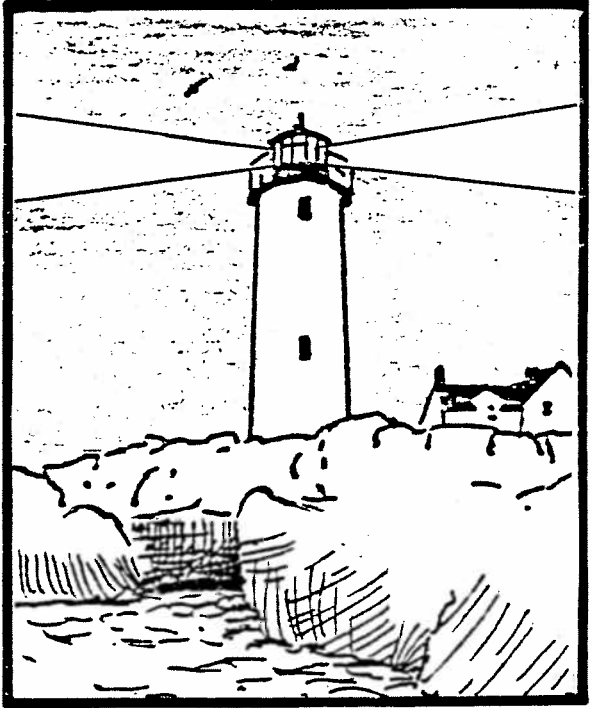

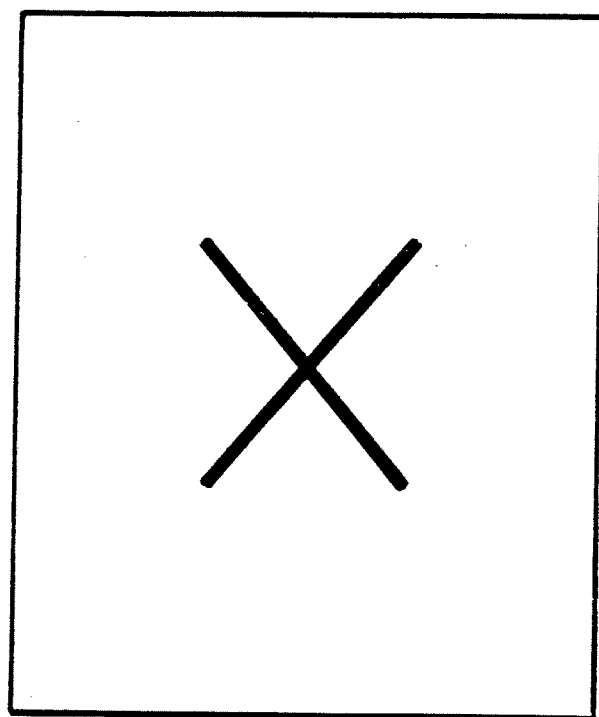

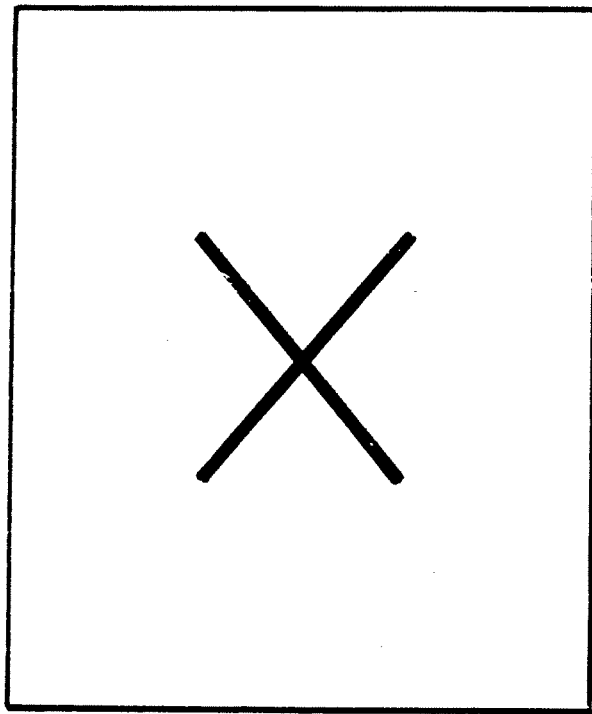

1

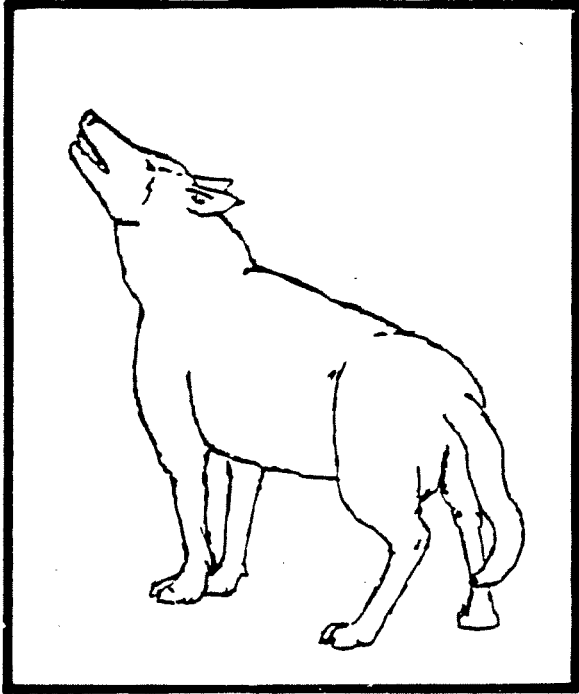

2



3

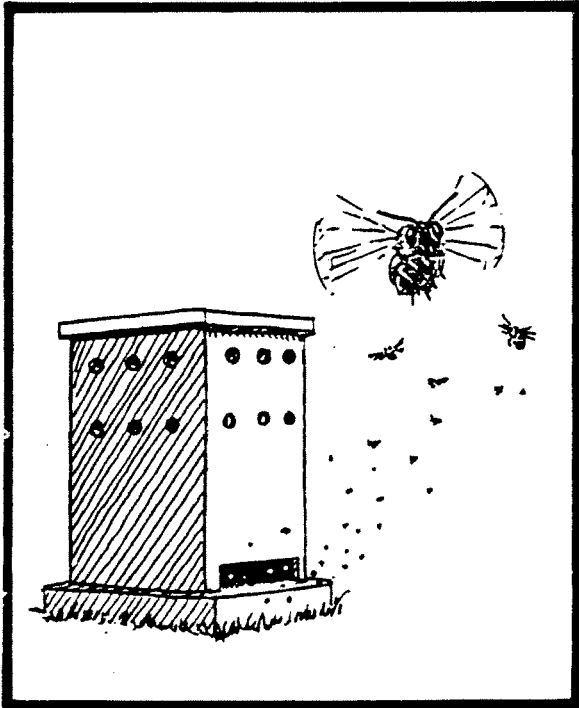

4



1

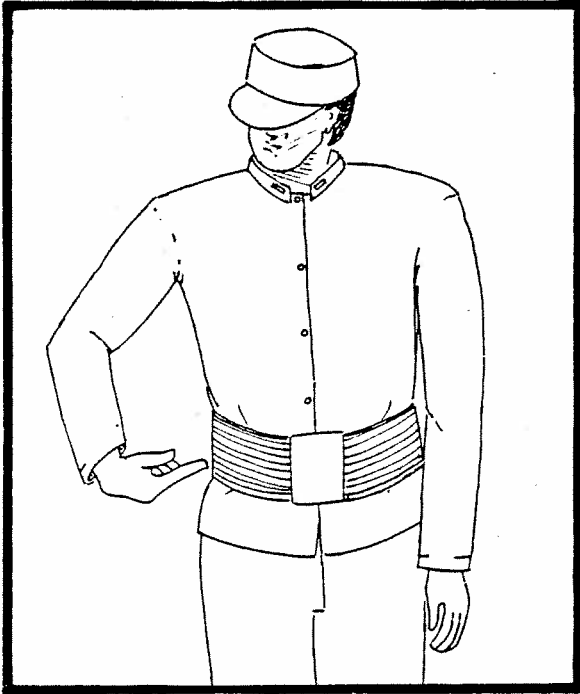

2

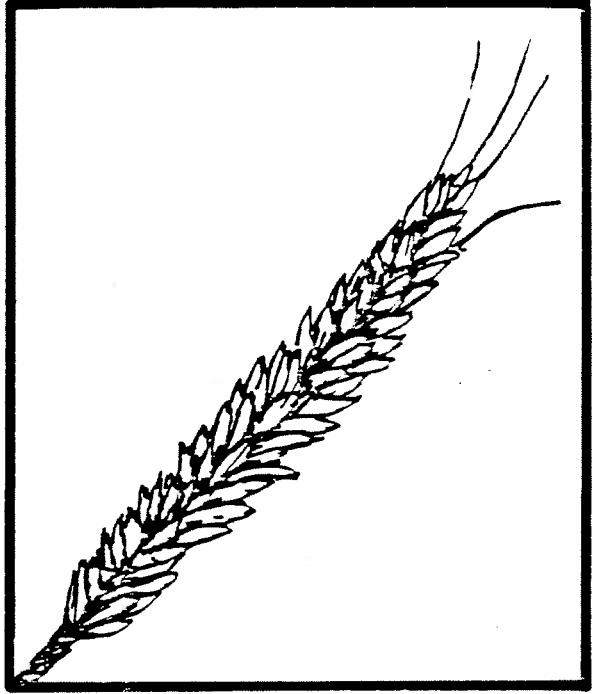

3



4

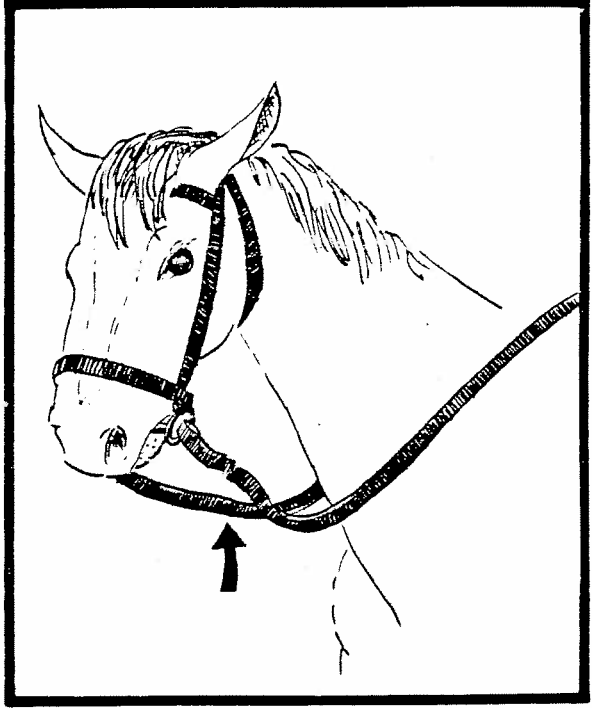

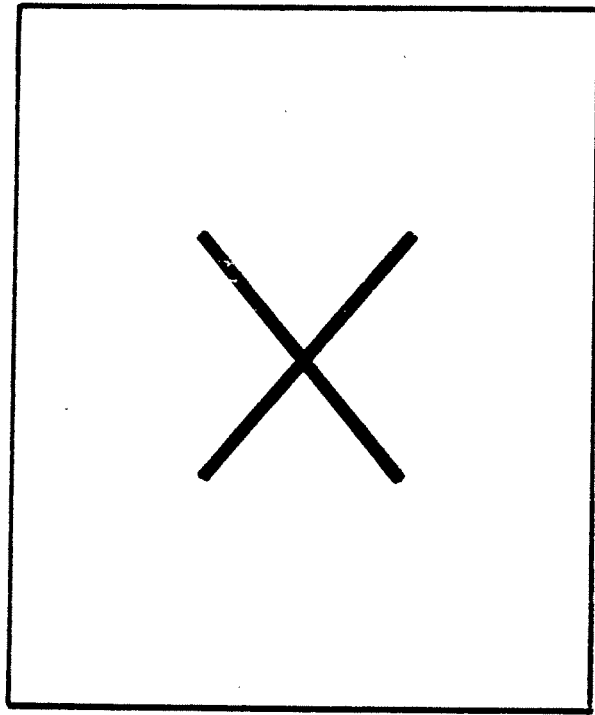

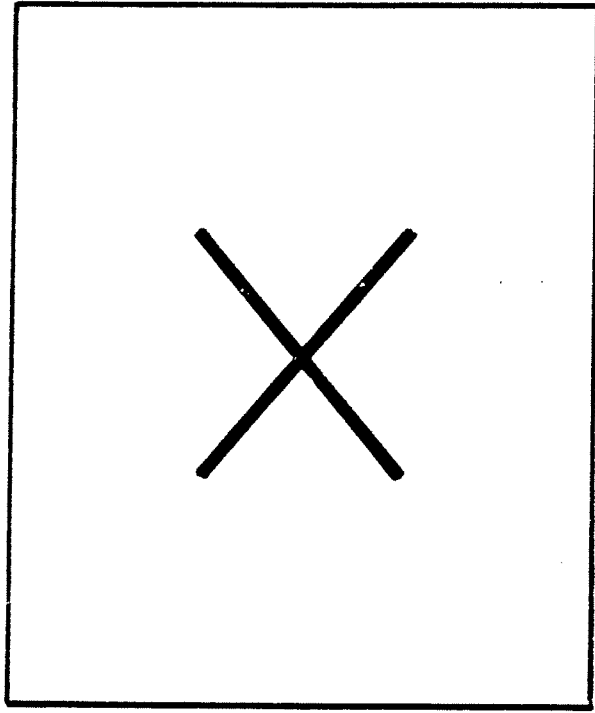



1

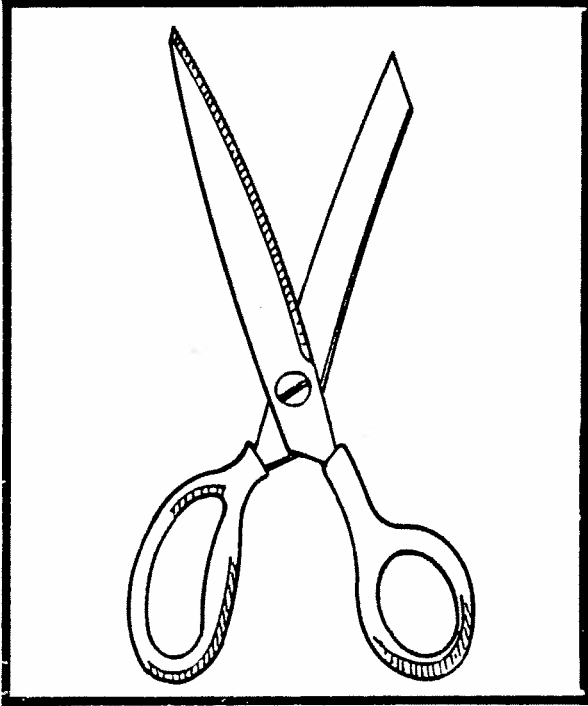

2

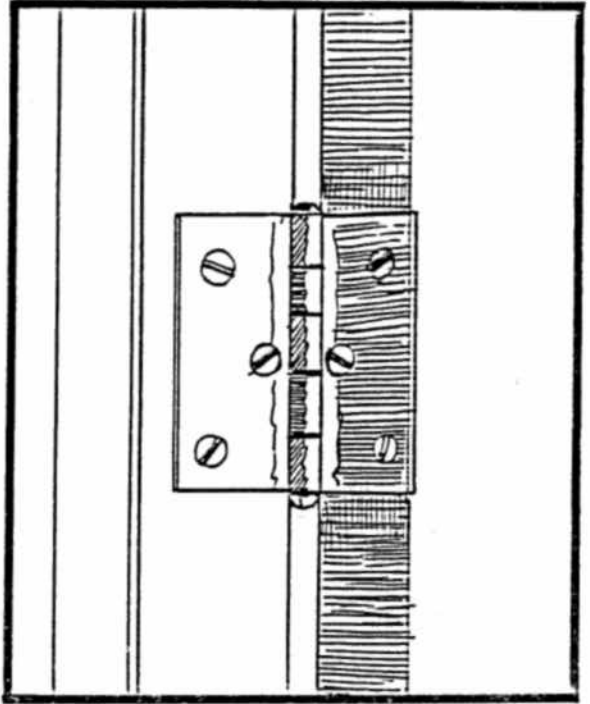

3

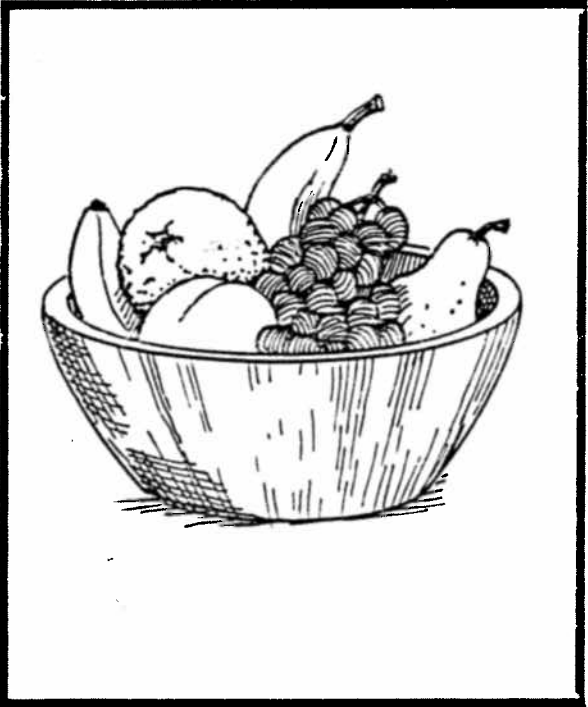

4

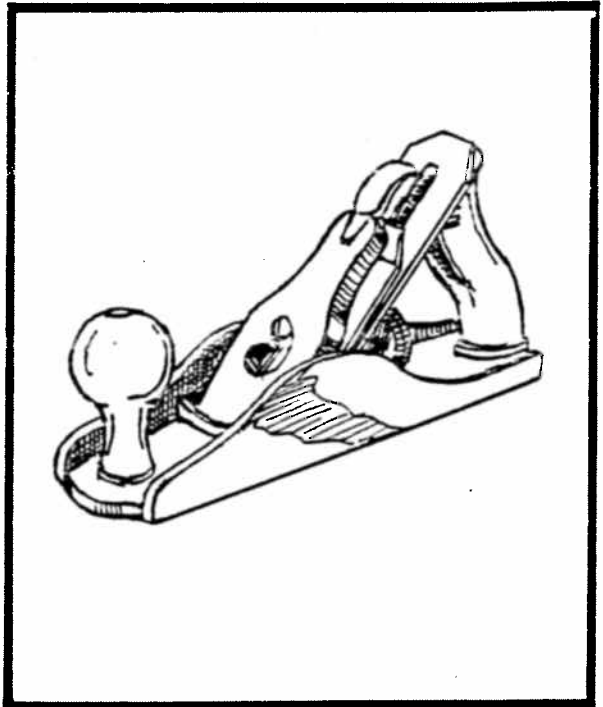

1



2

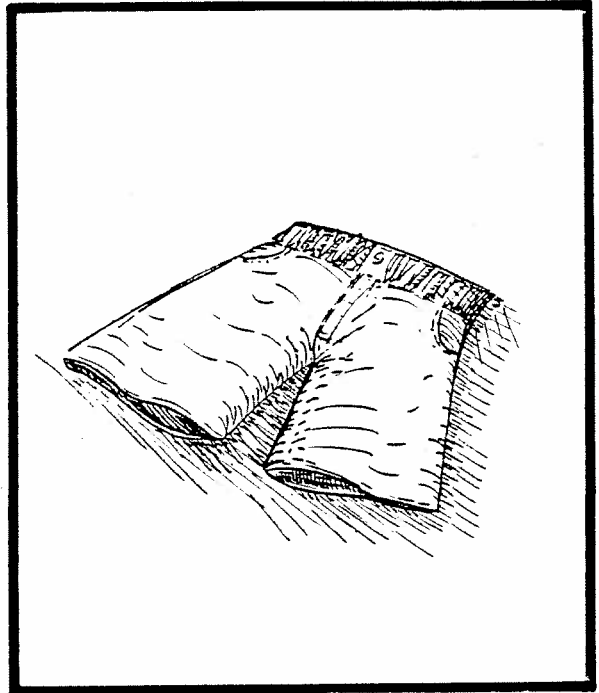

3

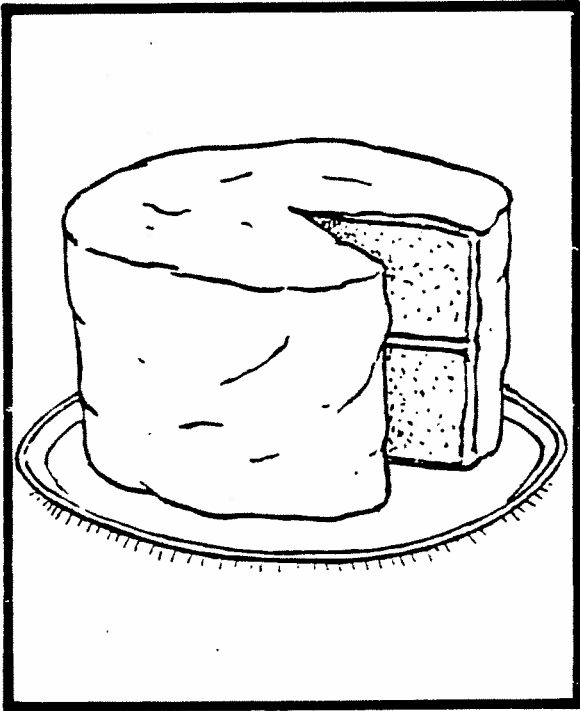

4

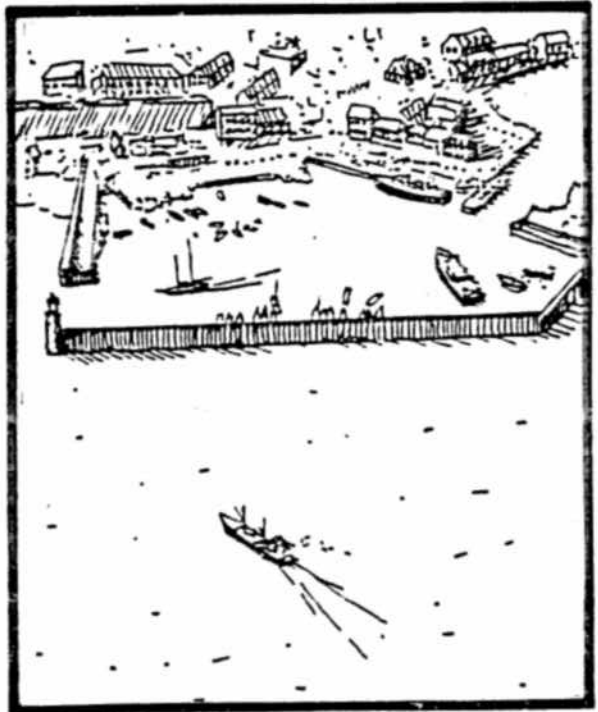

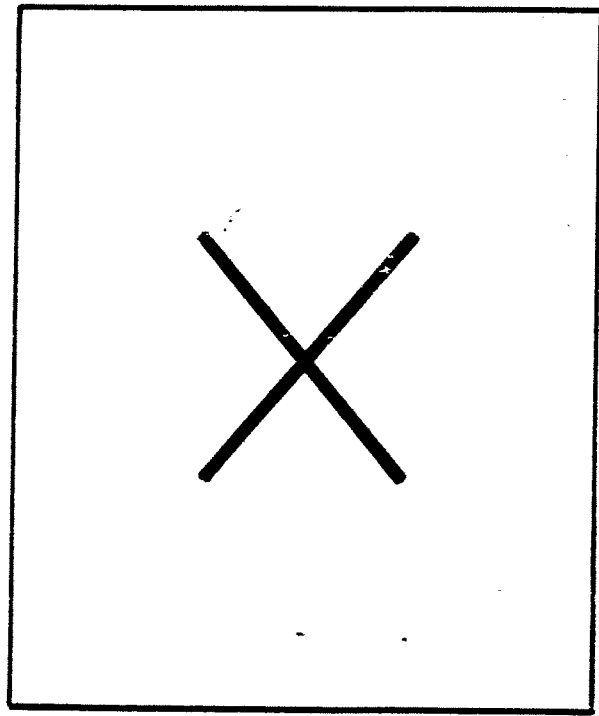

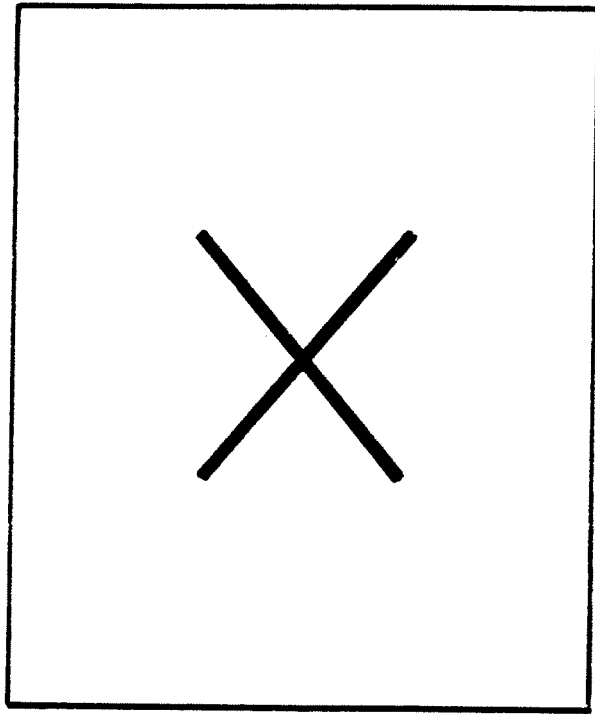

1

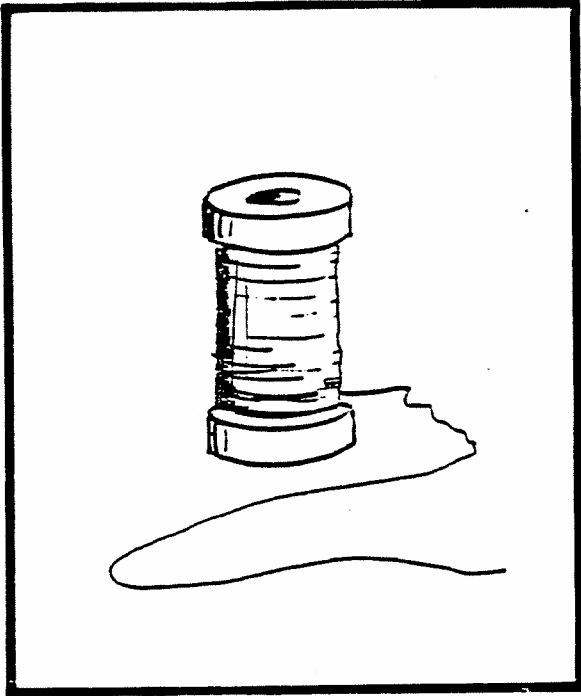

2

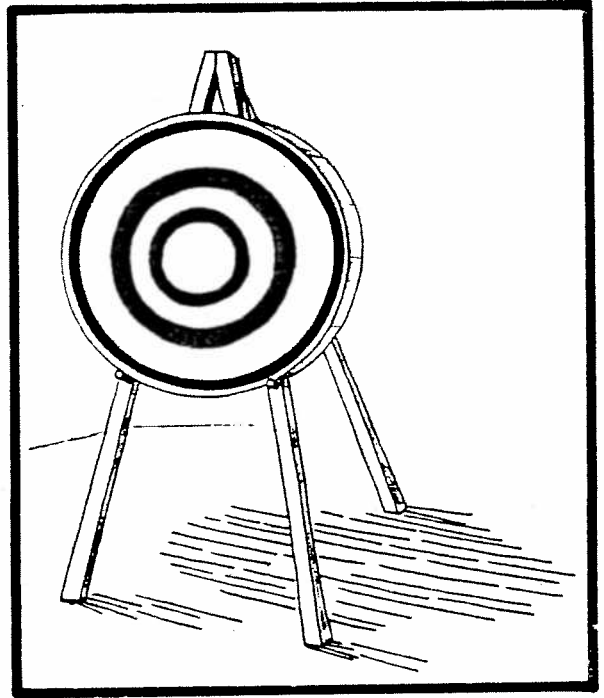

3



4

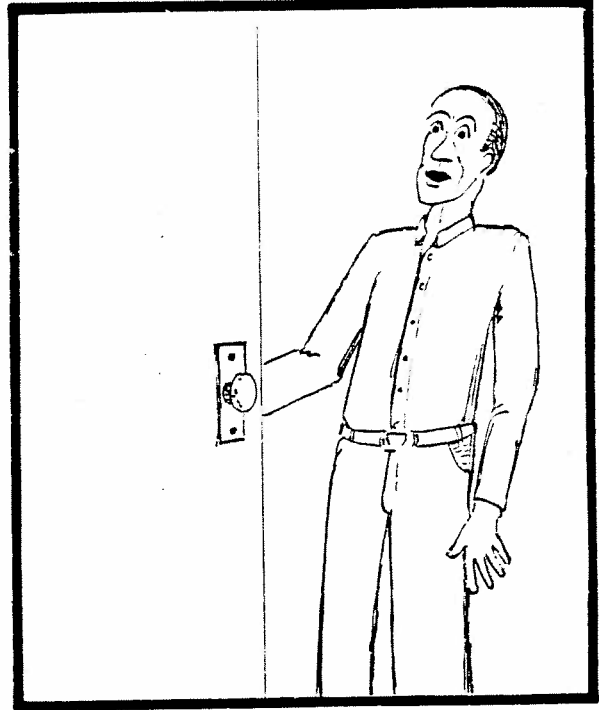

1

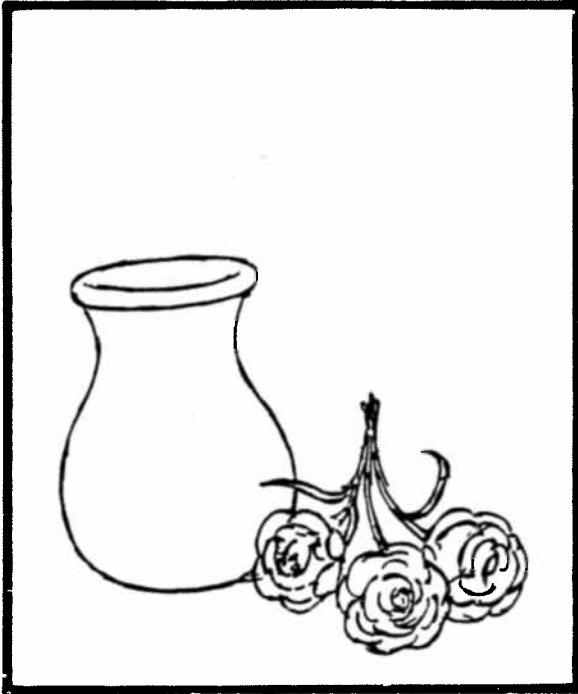

2

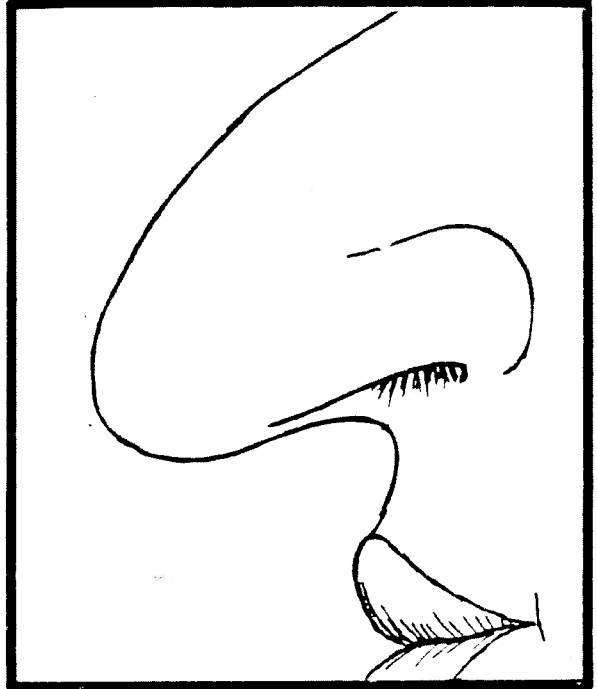

3

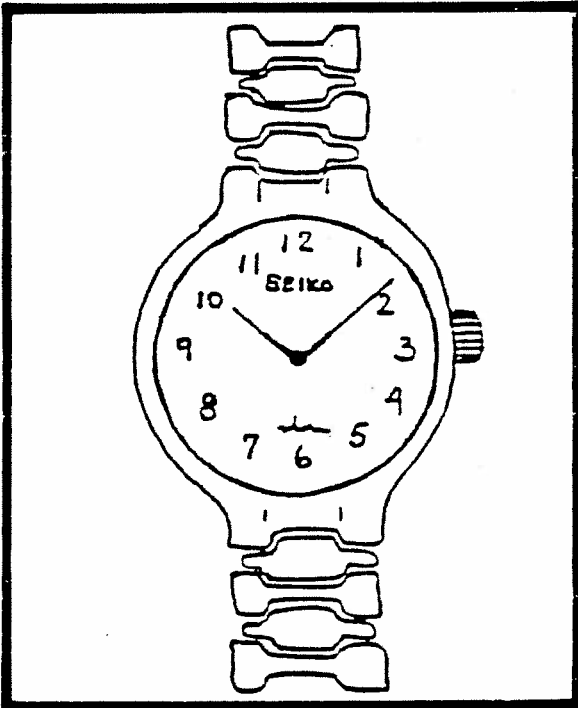

4



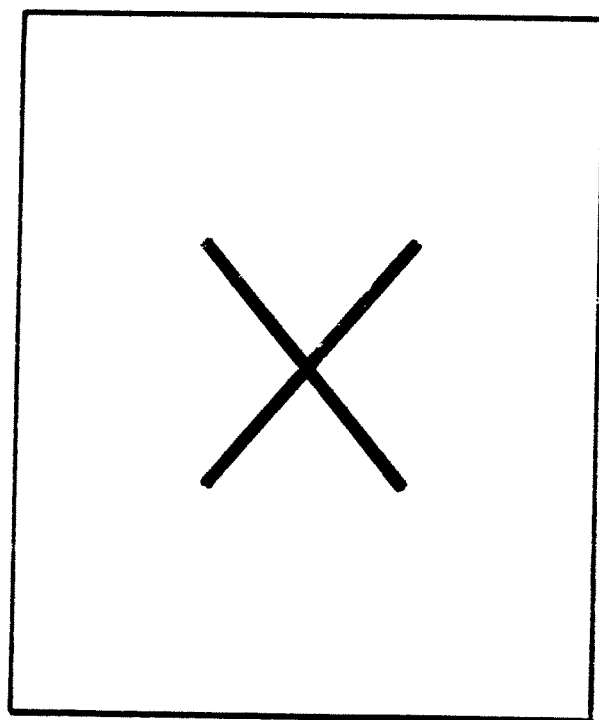

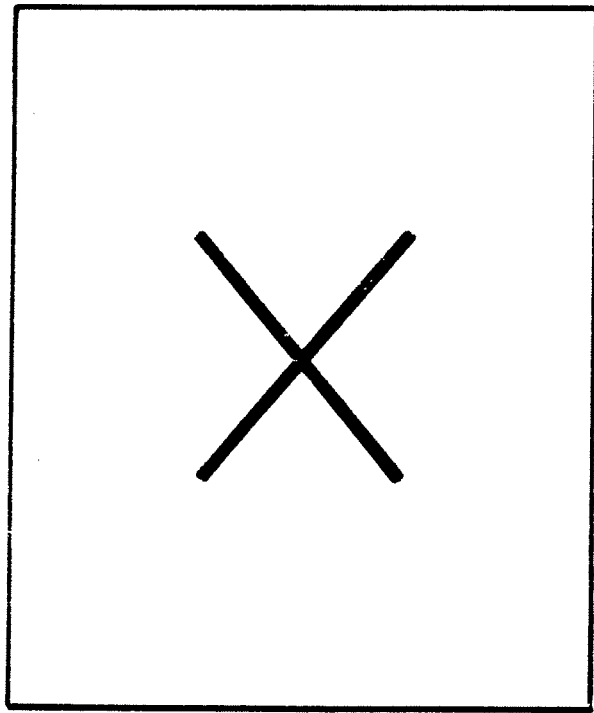



1

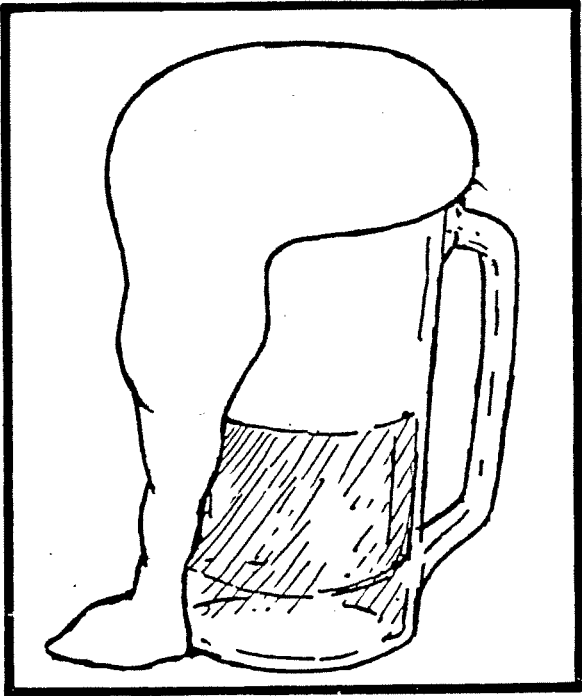

2

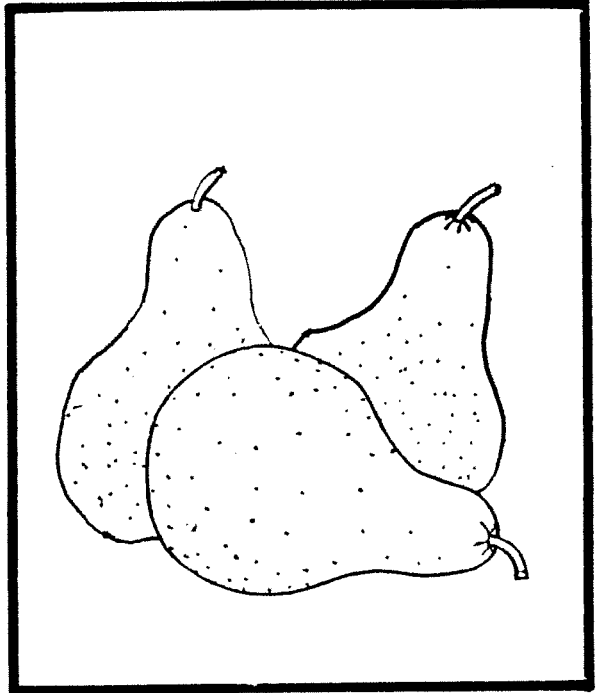

3

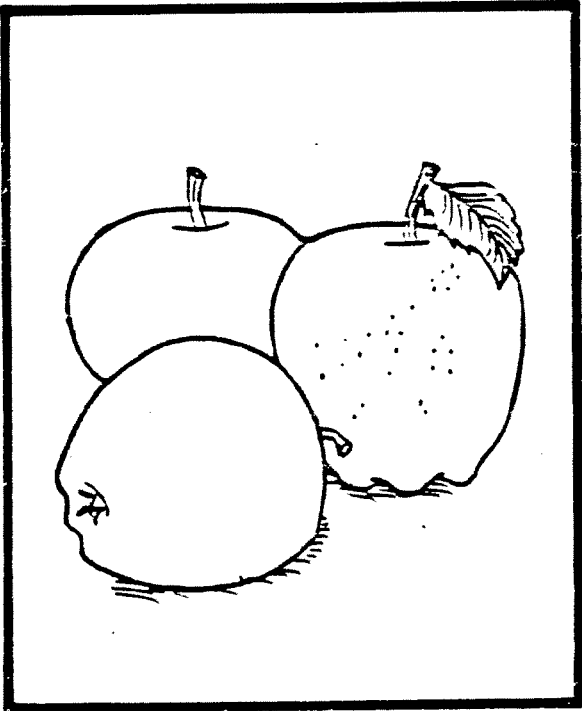

4

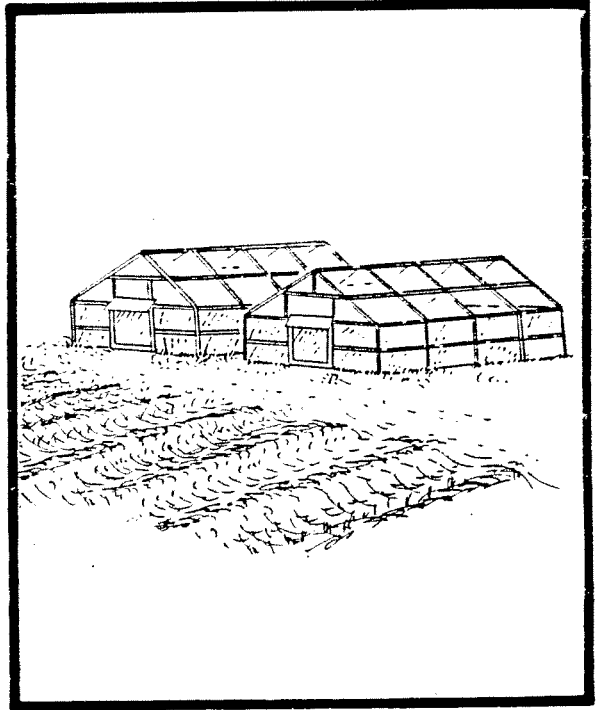



## COMPREHENSIUNEA STRUCTURILOR SINTACTICE

1

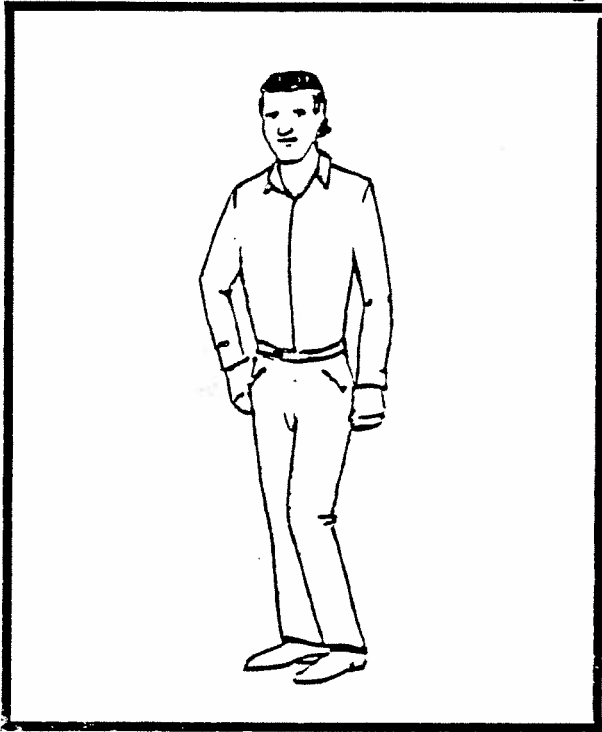

2

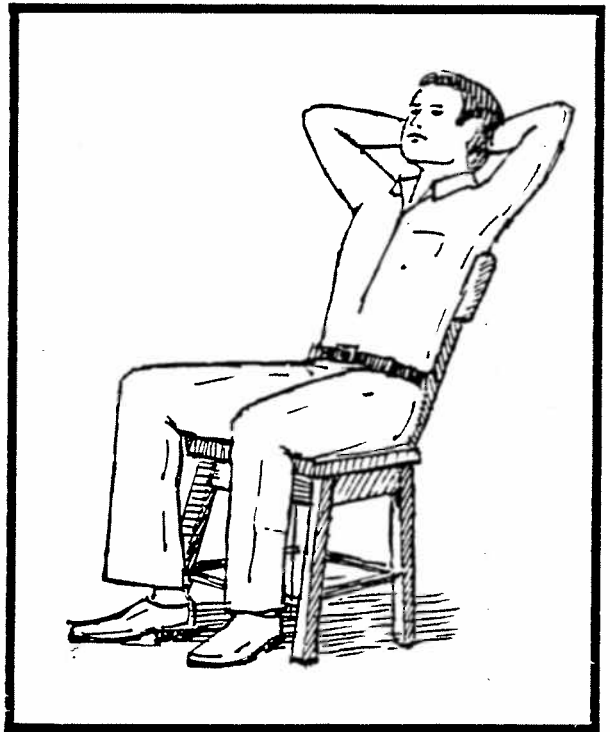

3



4



Exemplu

1

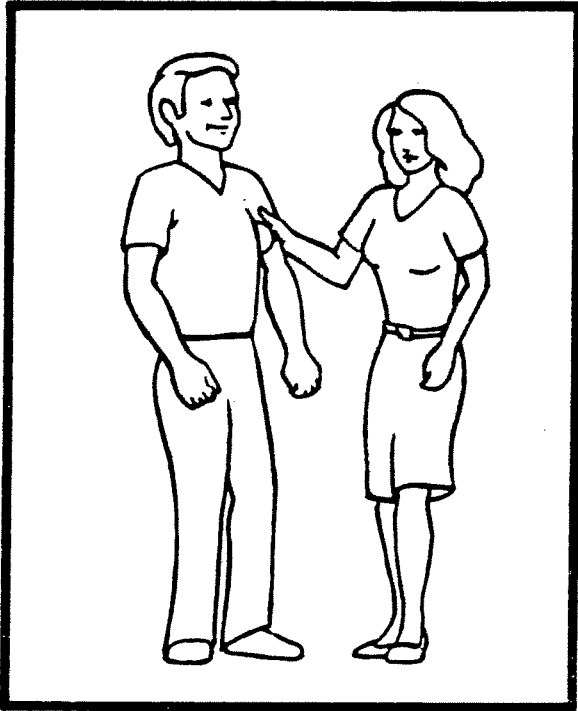

2

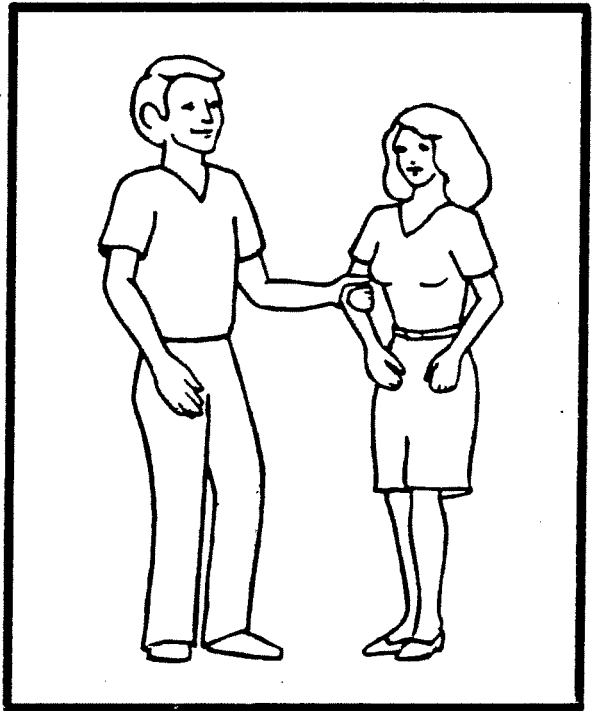

3

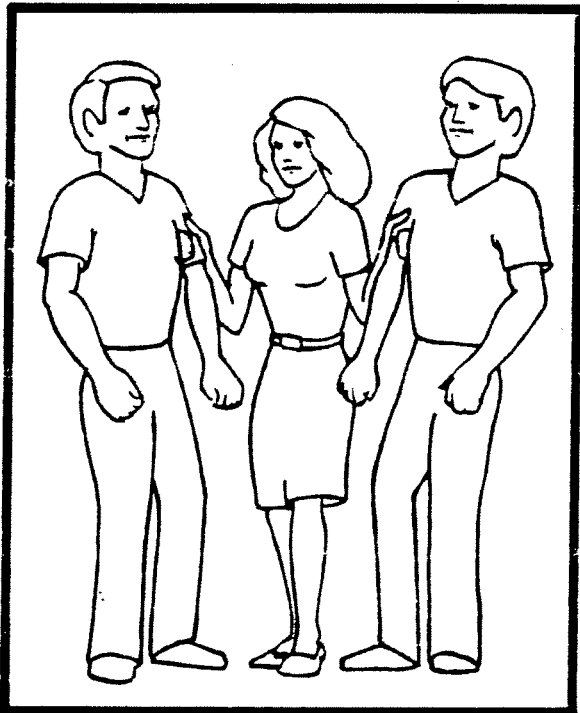

4

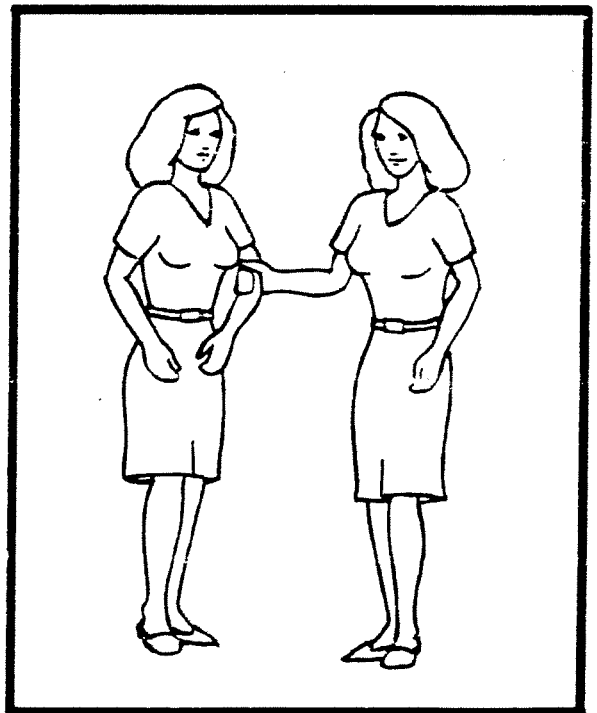

1

1

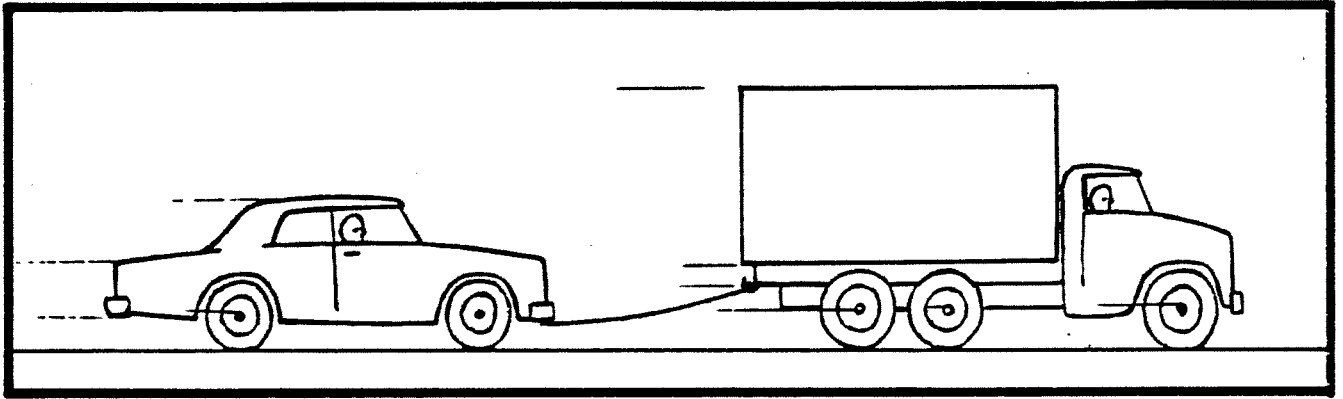

2

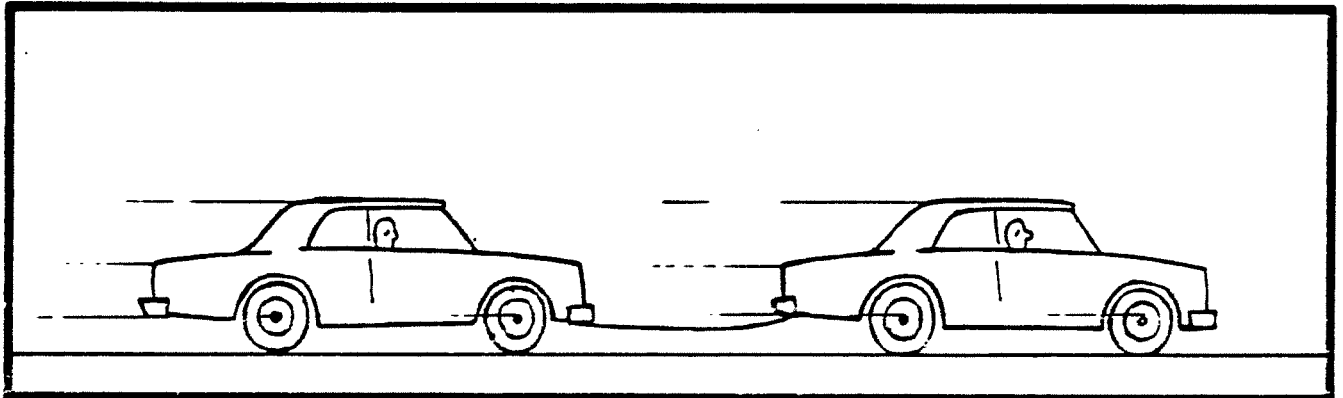

3

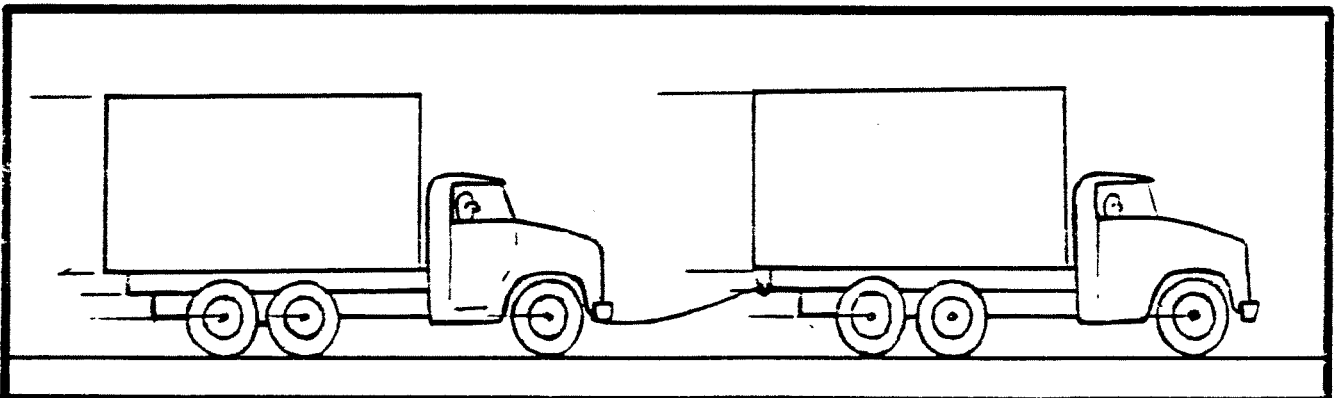

4

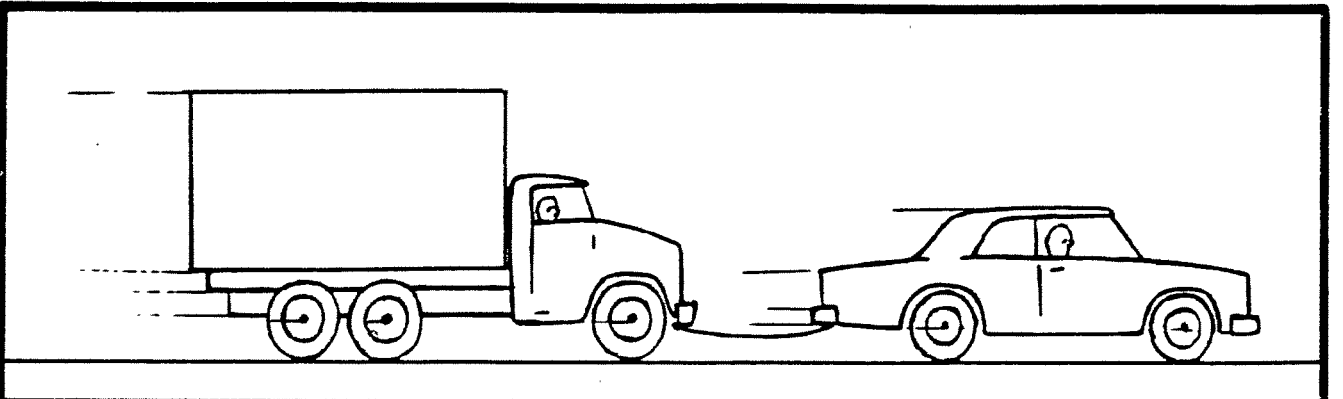

2

1

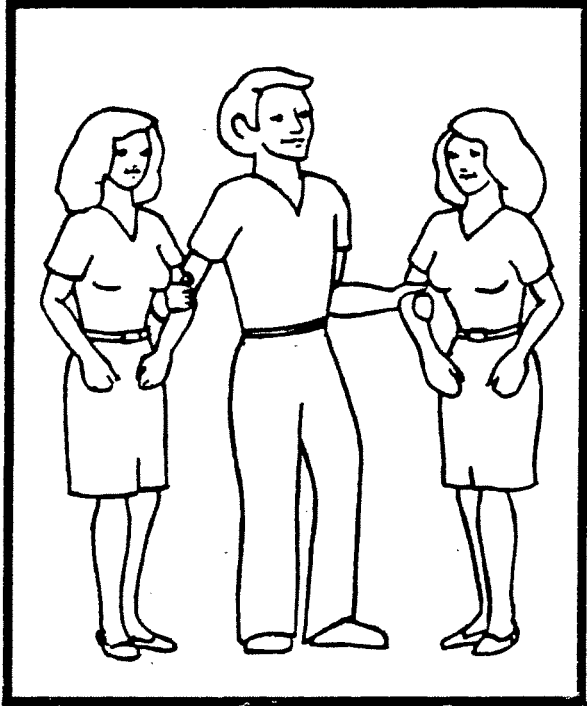

2

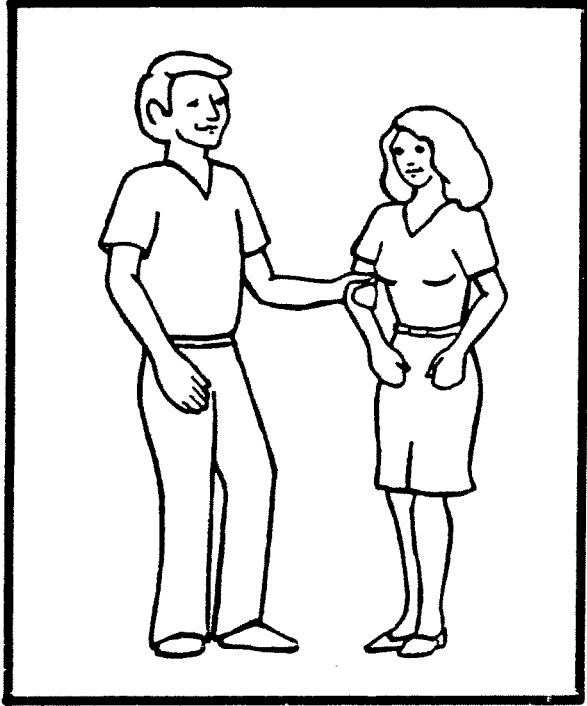

3

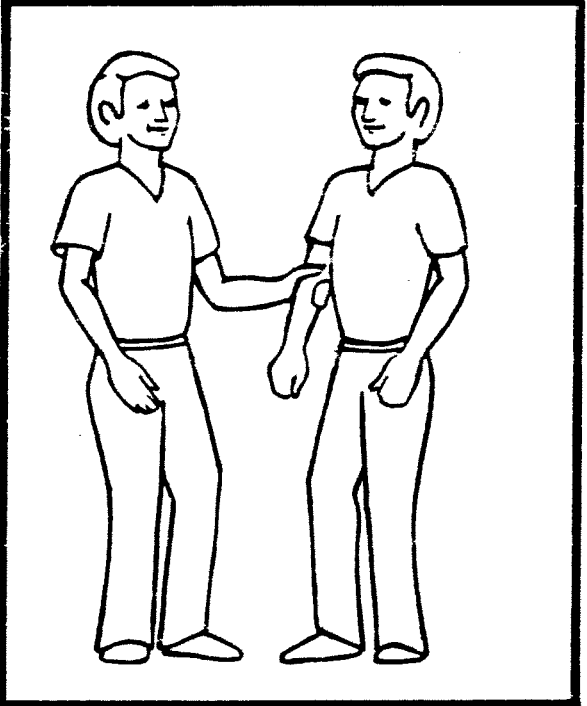

4

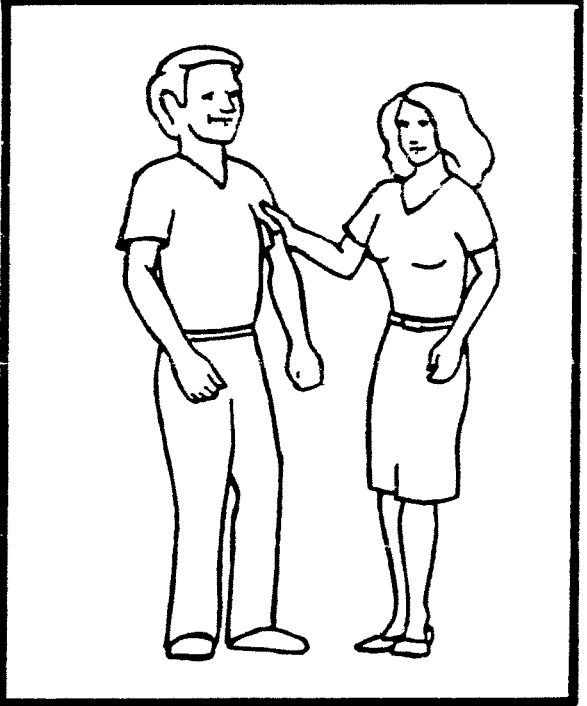

3

1

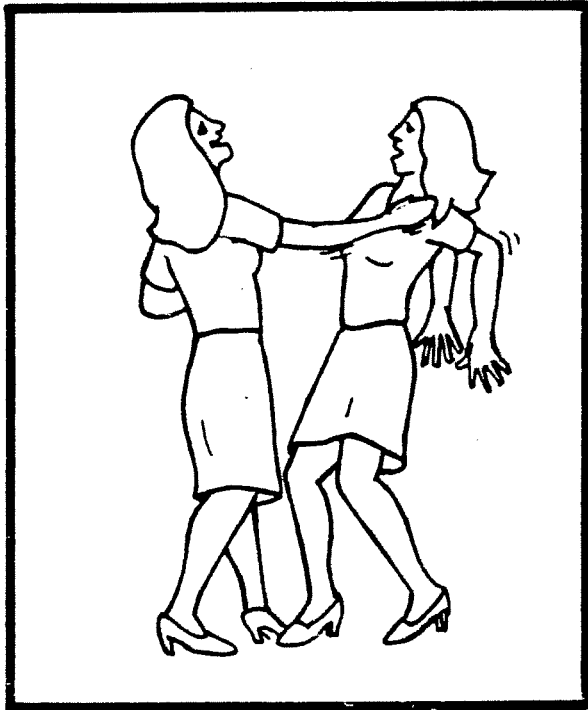

2

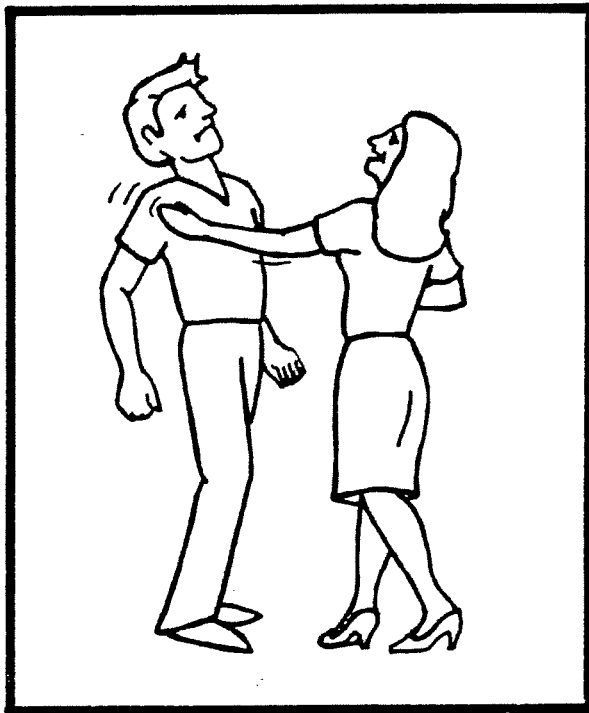

3

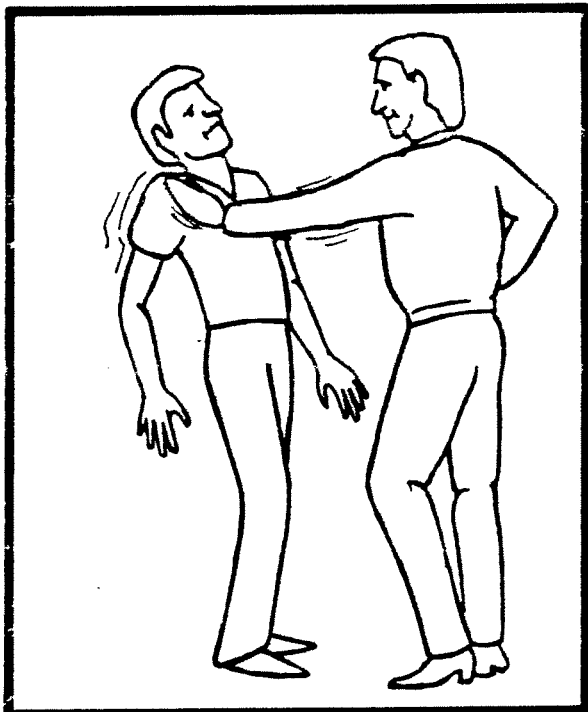

4

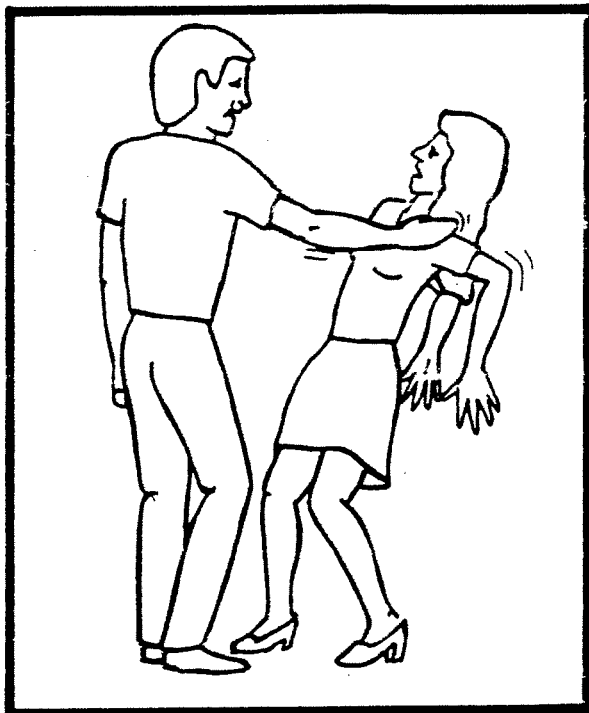

4



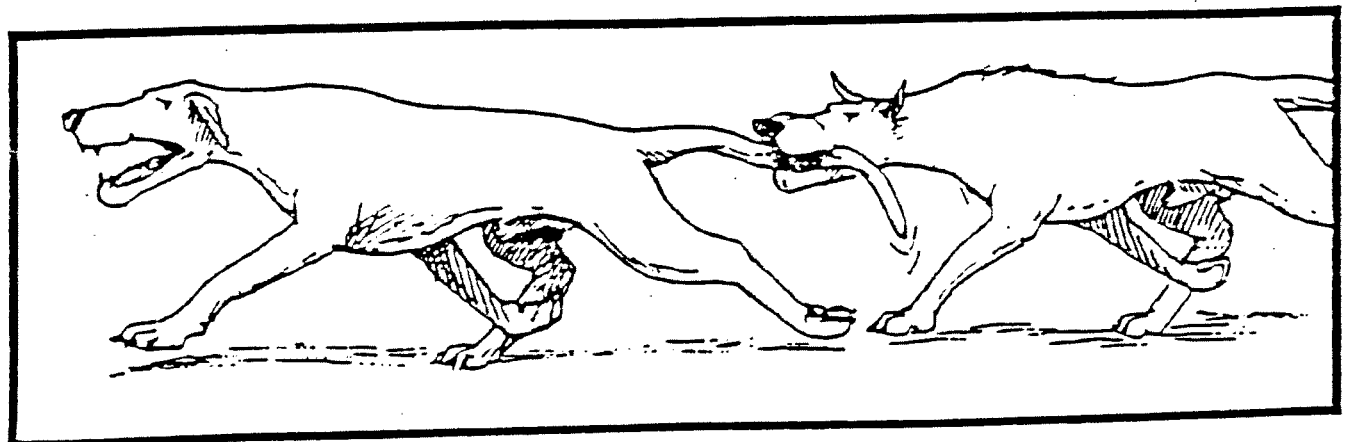
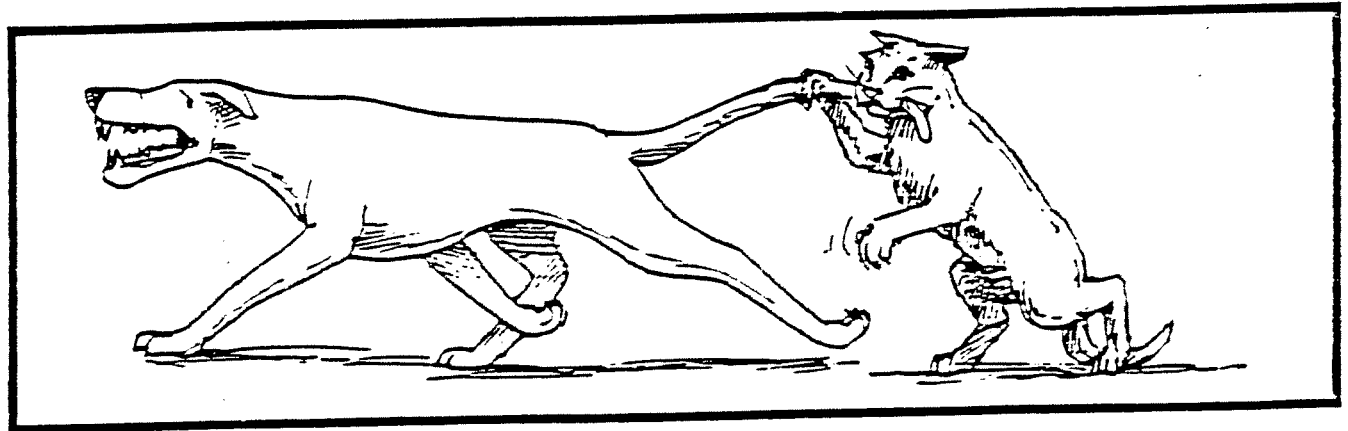
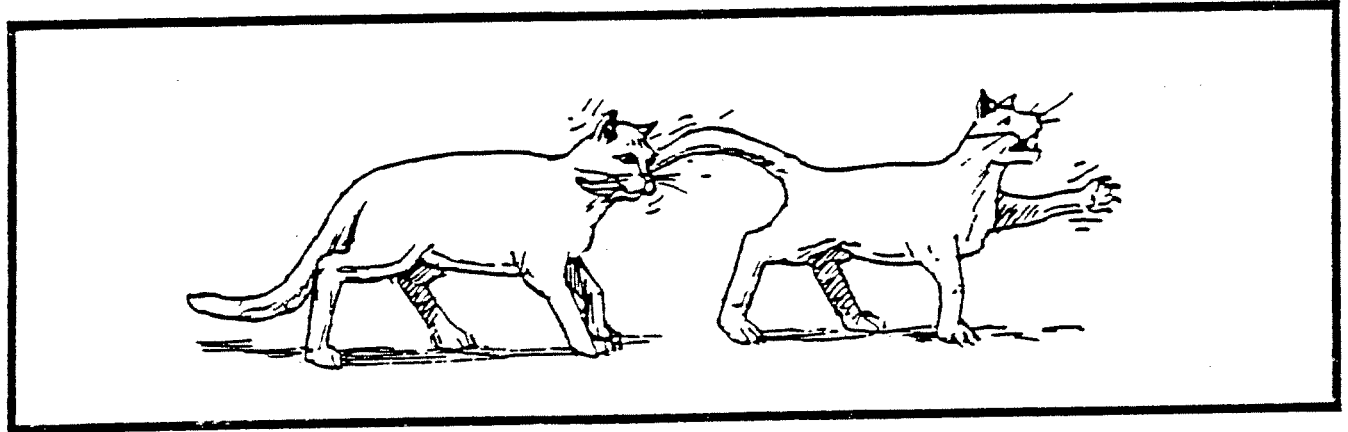
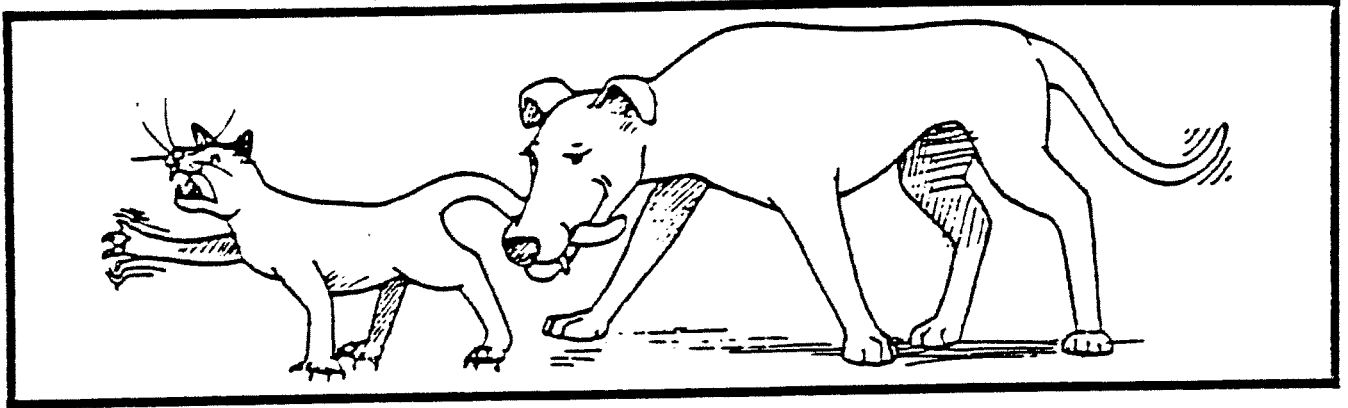

1

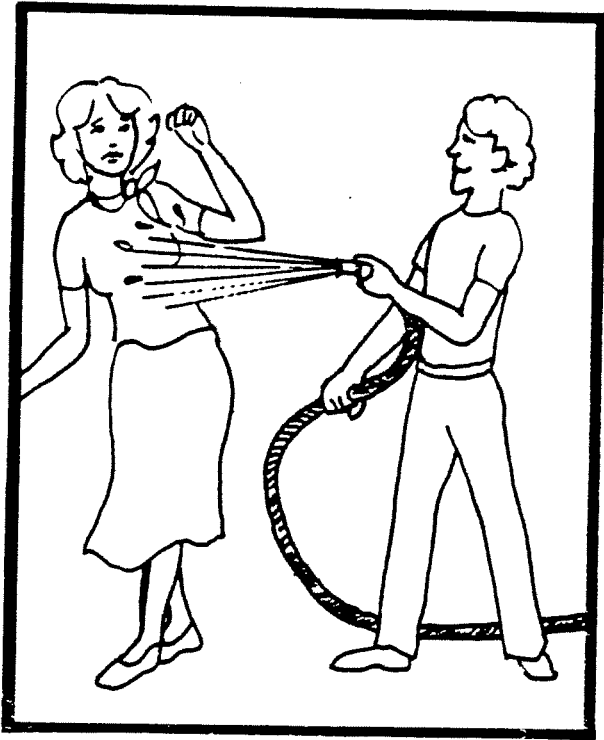

2

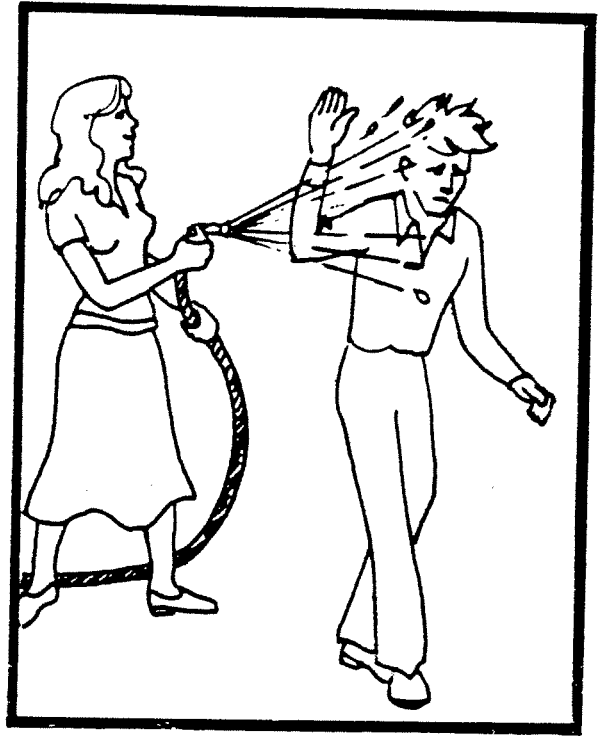

3

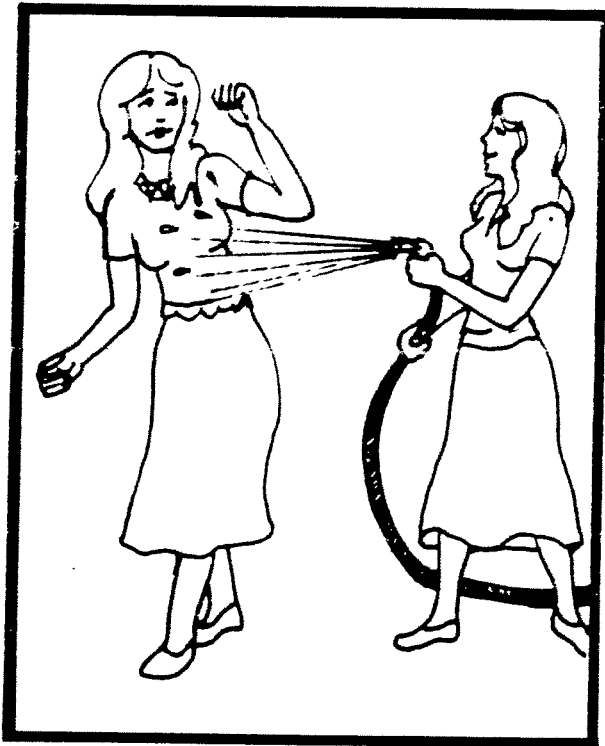

4

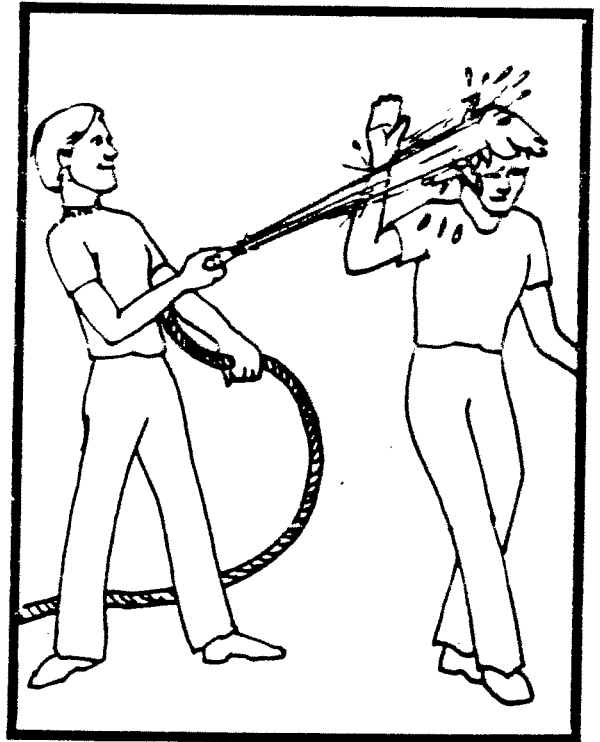

6

1

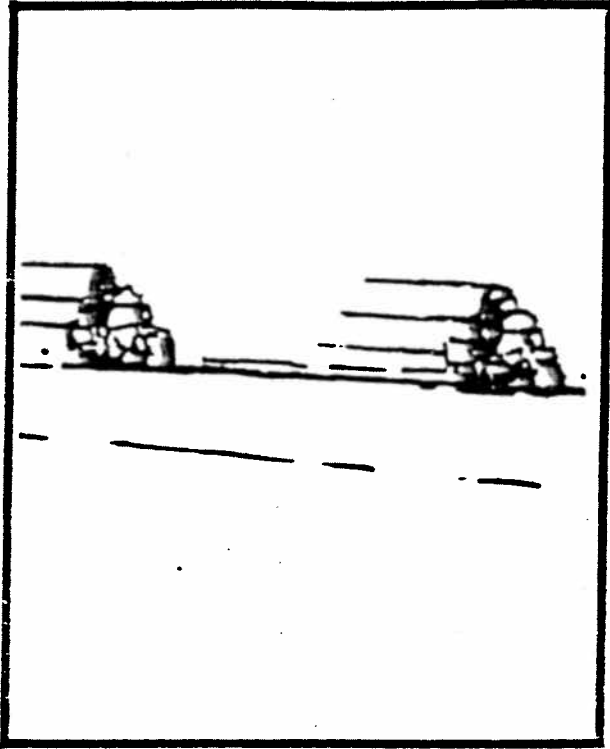

2

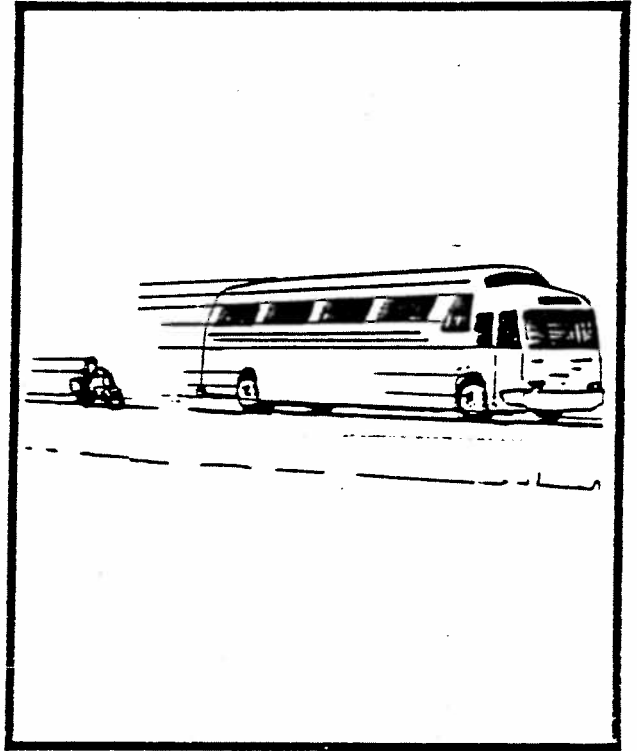

3

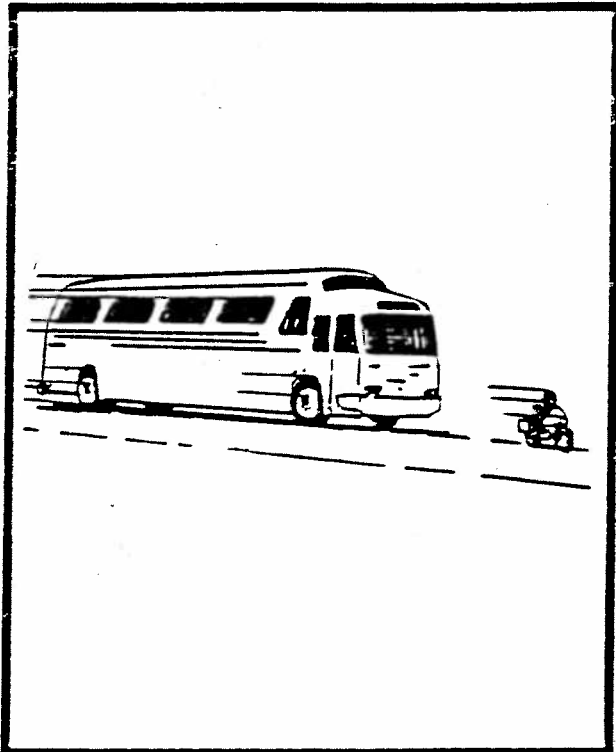

4



7

1

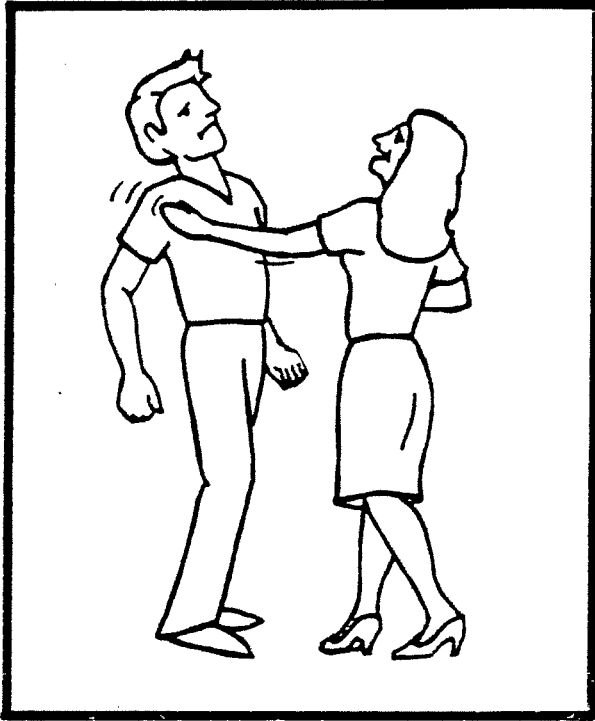

2

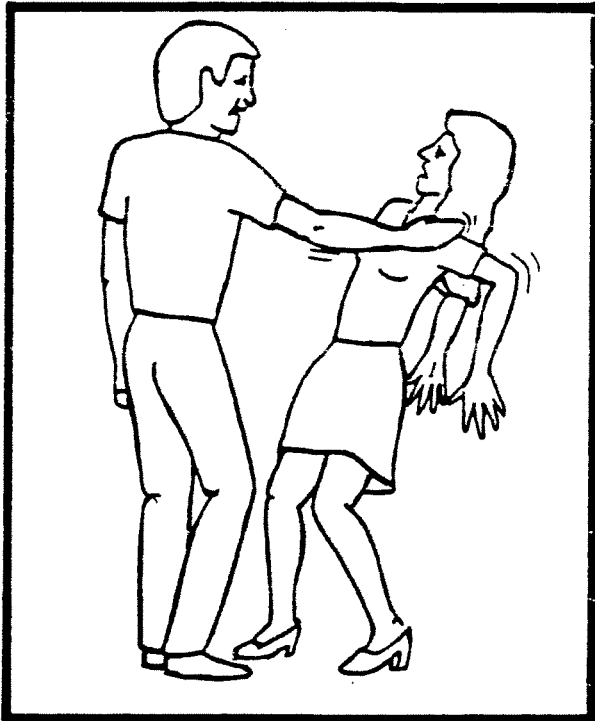

8

1

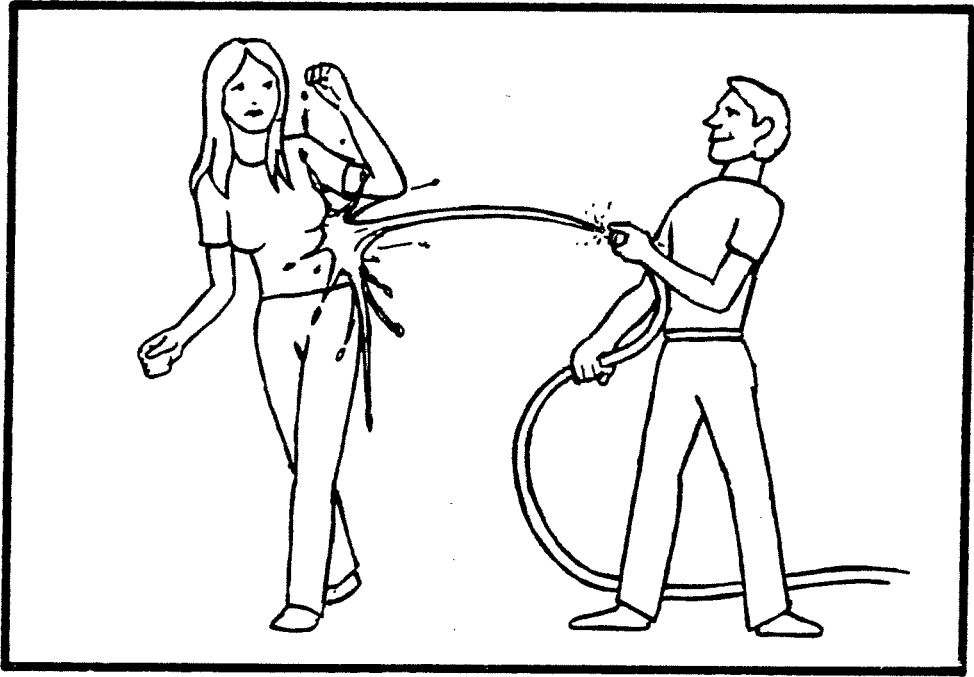

2

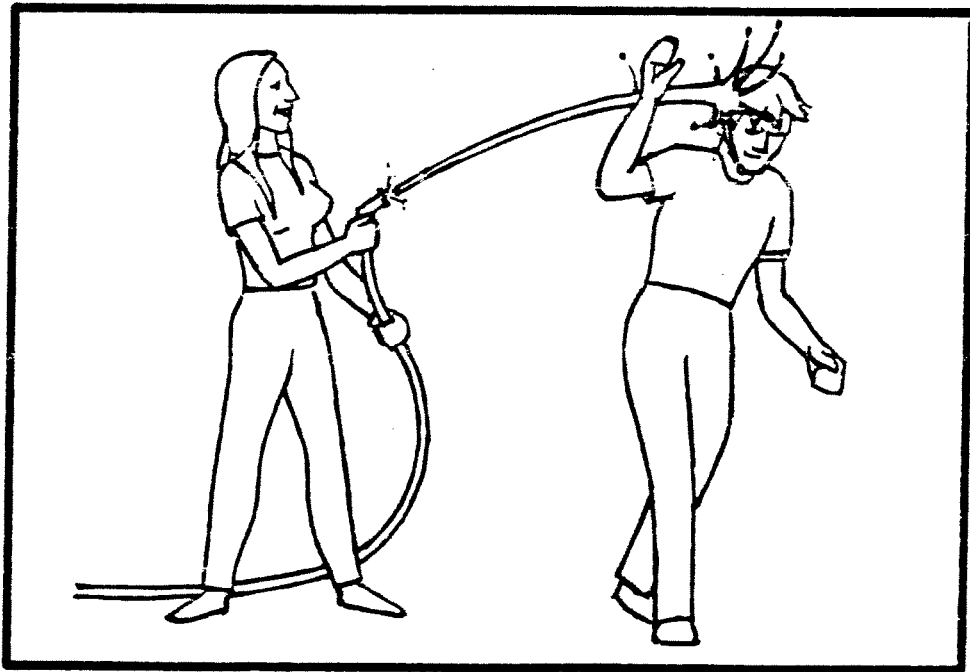

9

1

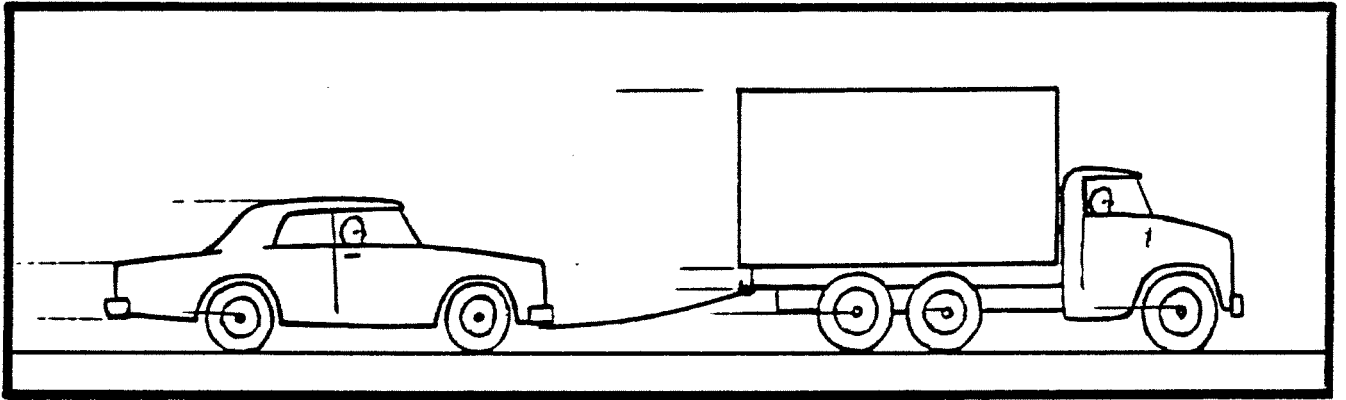

2

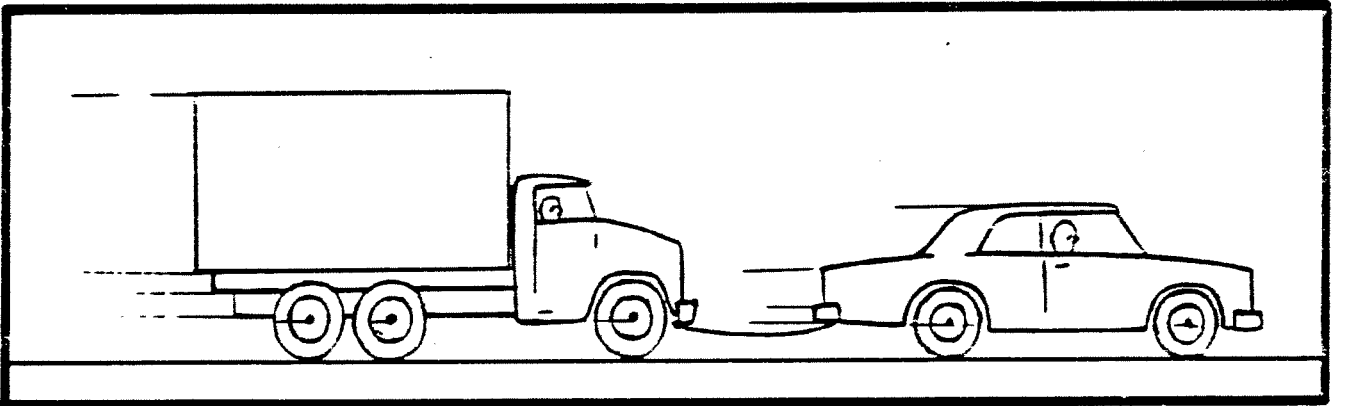

10

1



2

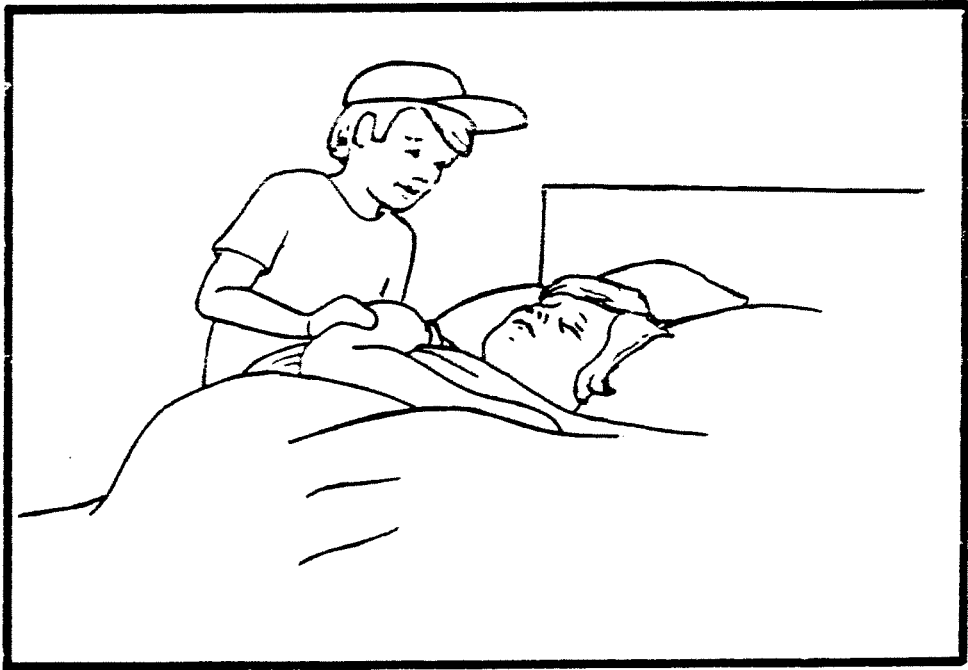

11

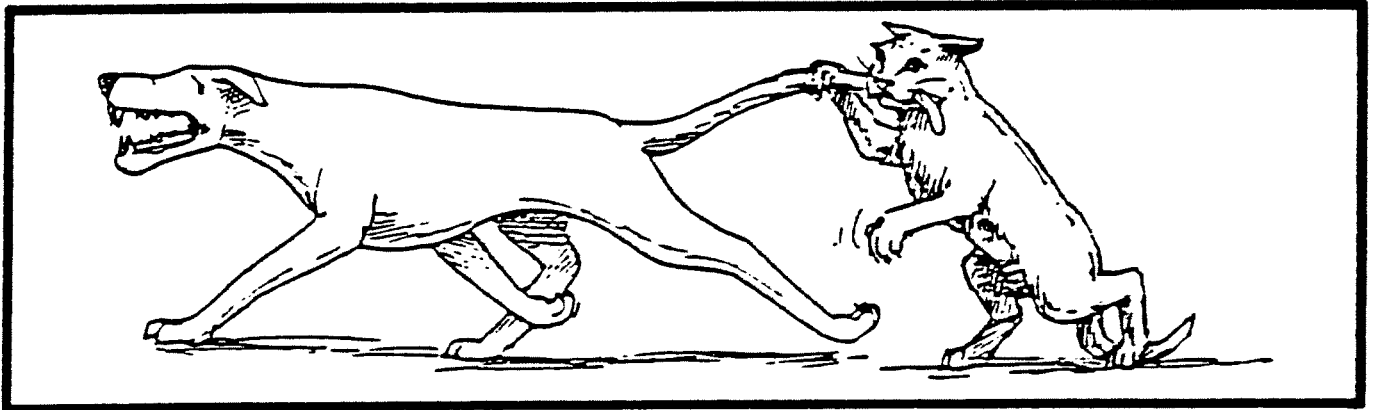
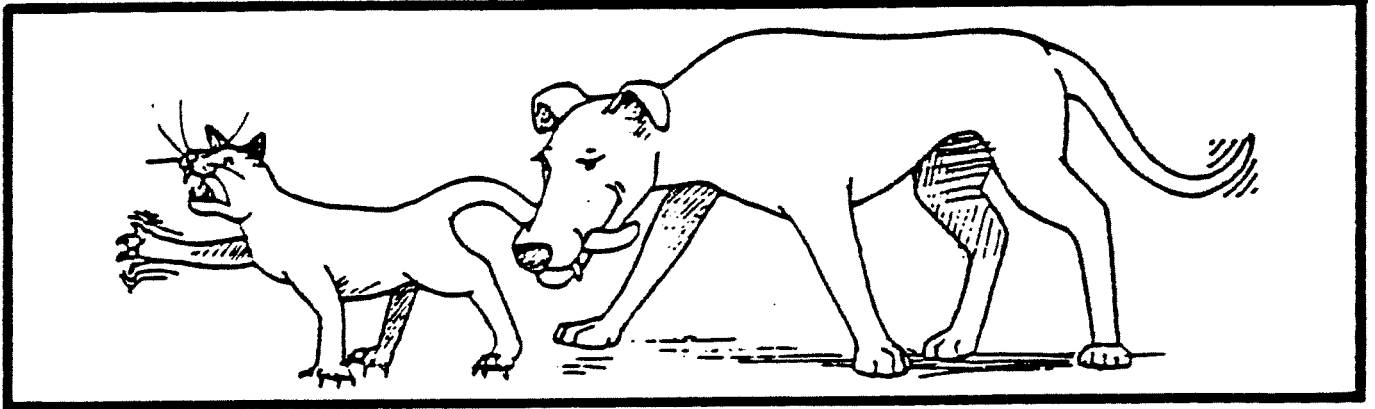



1



2



13

1

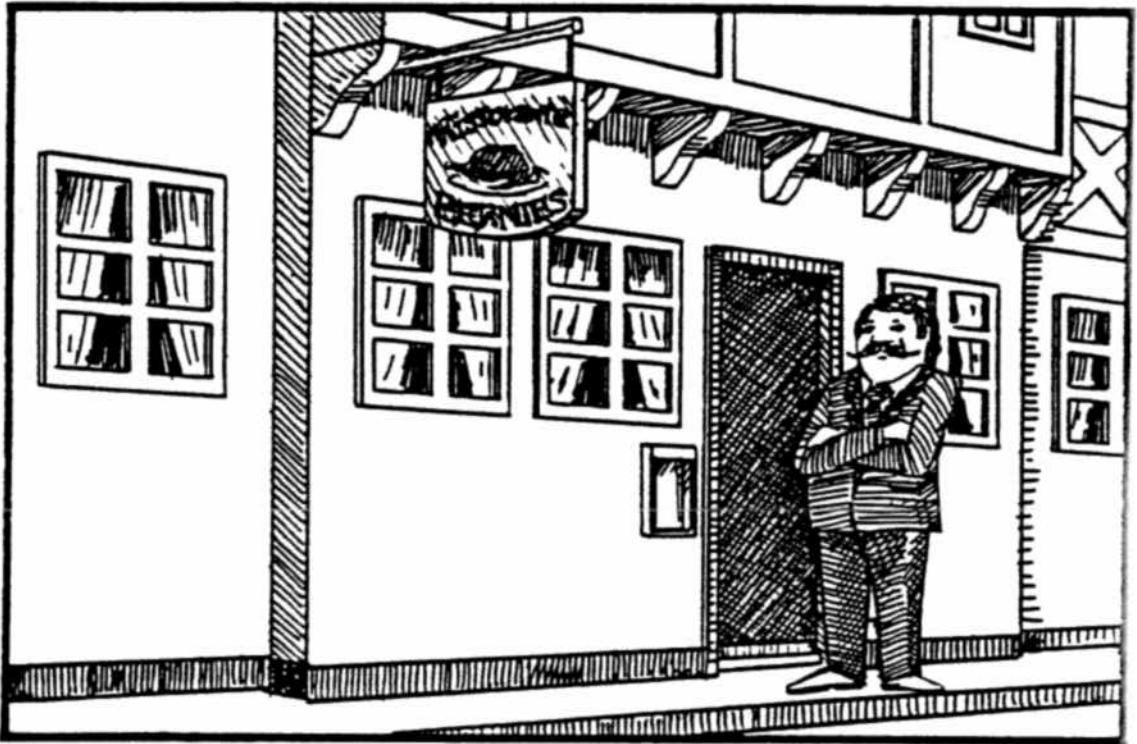

2

1



1

2

1

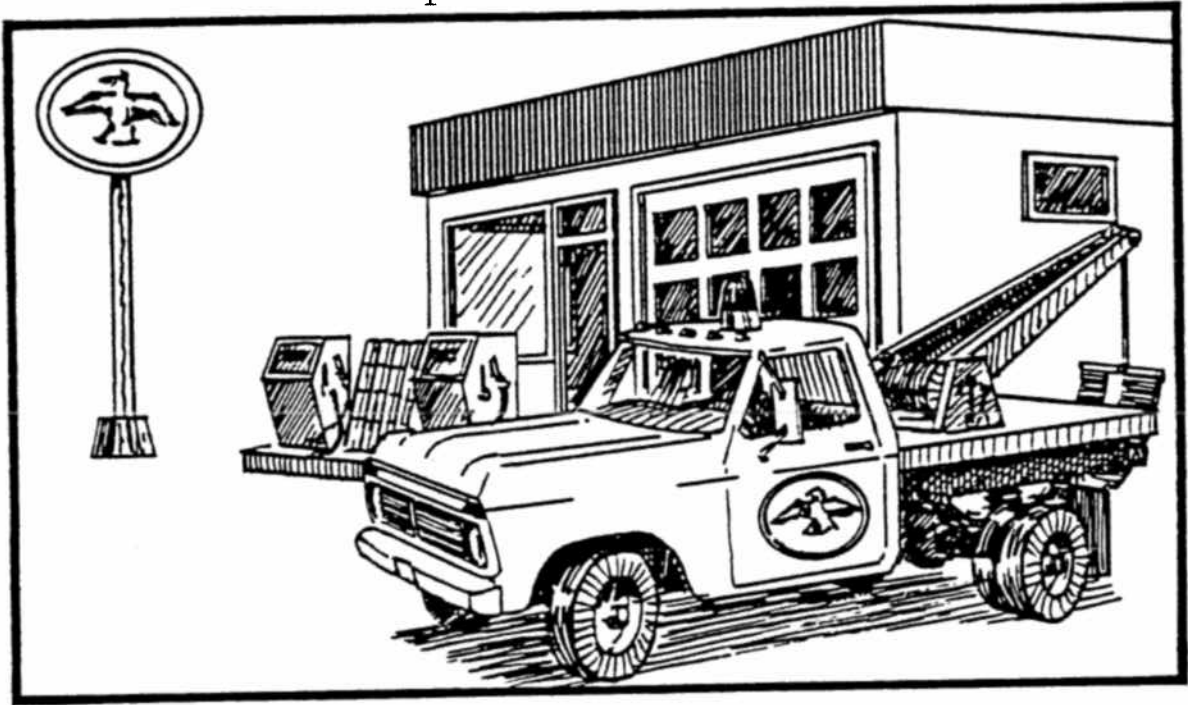

2

2



1



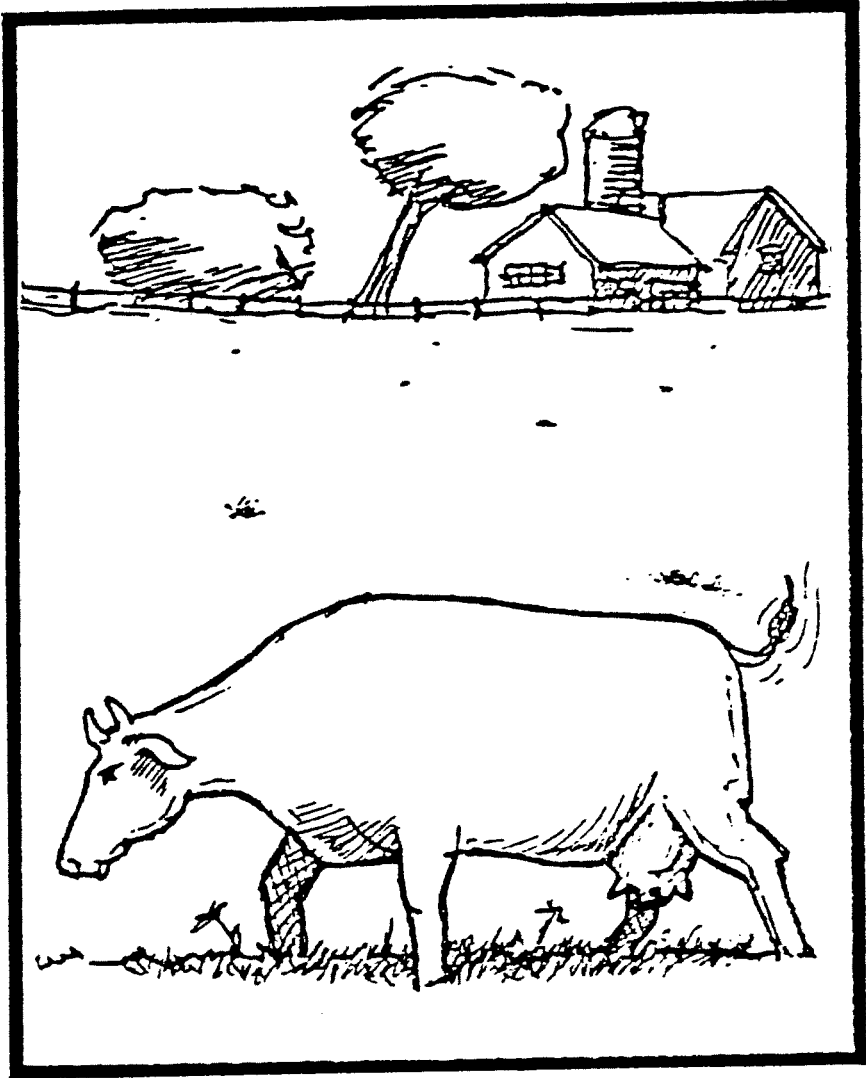

1

2

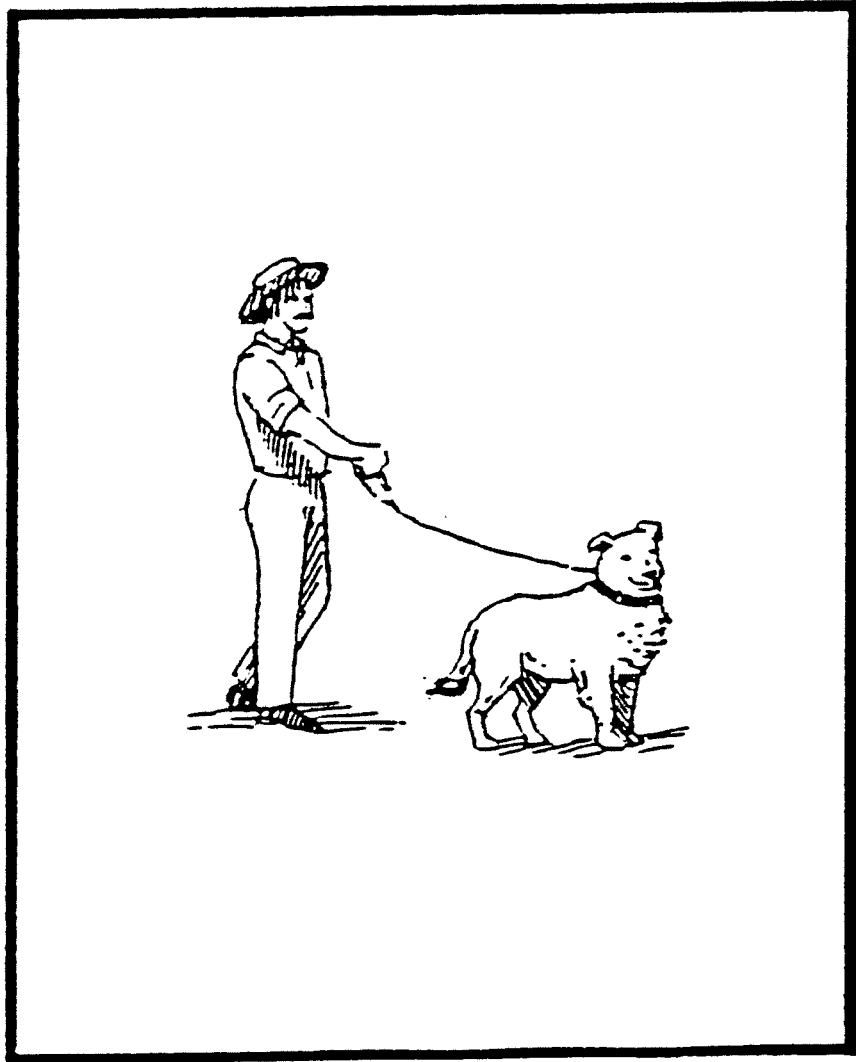

1

2



1



2

1

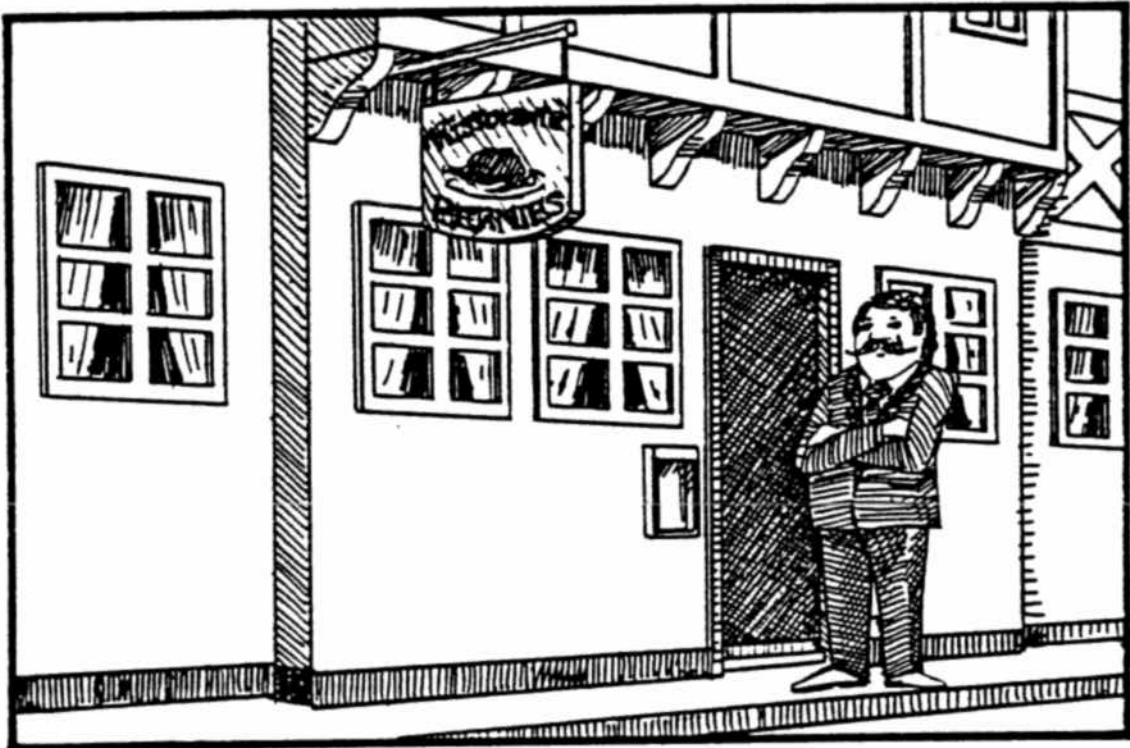

2



1

2

1

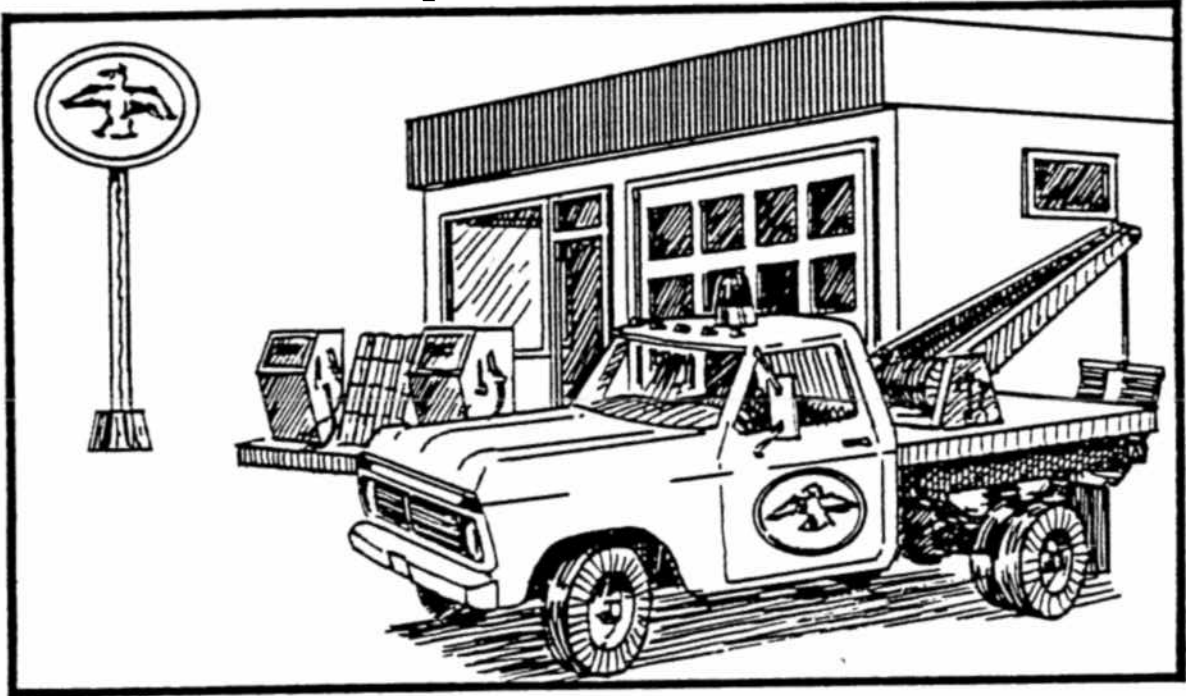

2

2



1



1

2

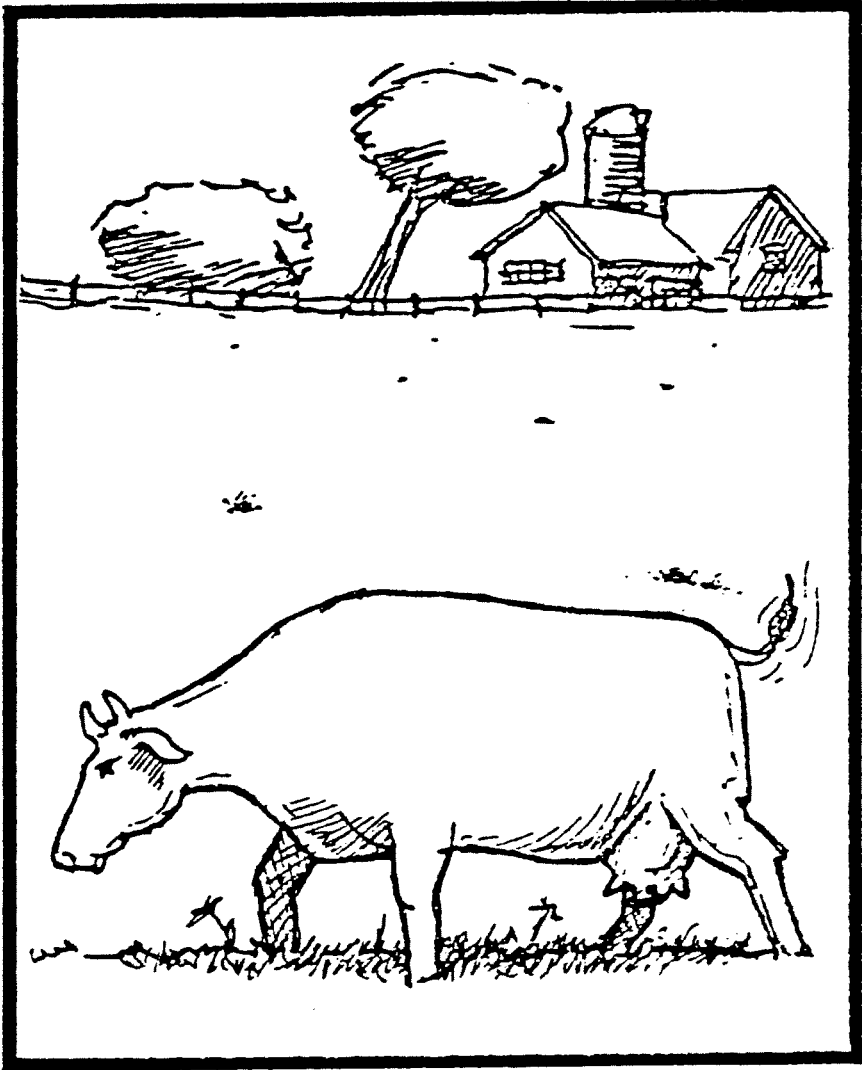

1

2

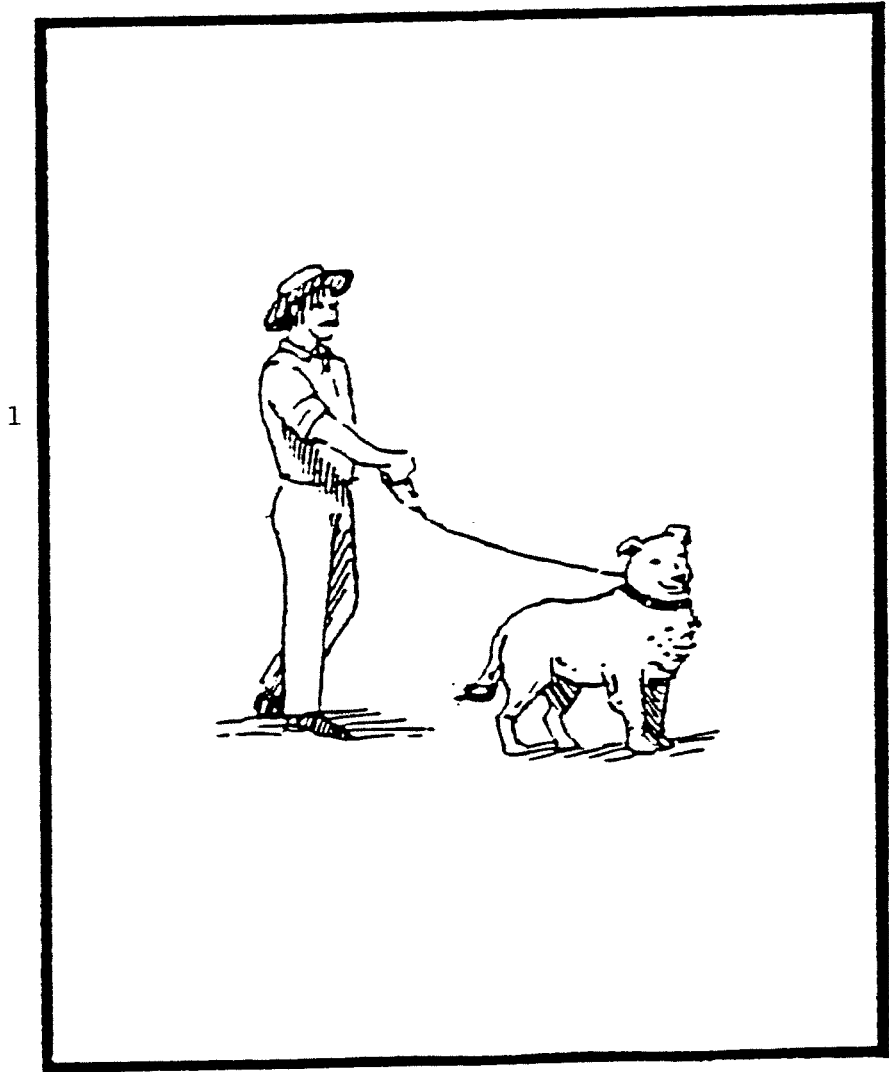





1

2



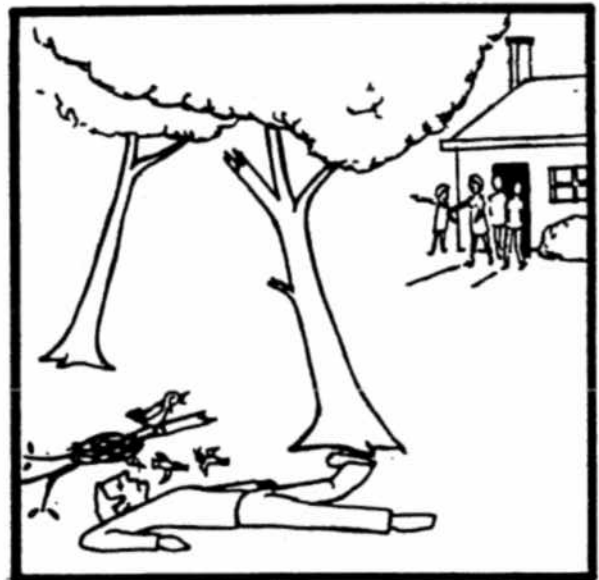
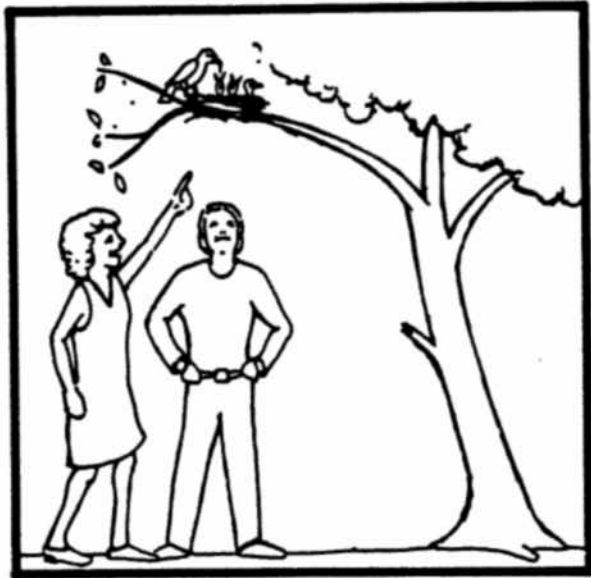

bară

muc

zână

ramă

lac

şal

sar

brîu

fir

pere

Băiatul ține fata.

Ea îl împinge.

Pisica este mușcata de cîine.

Este camionul care trage mașina.

Băiatul nu împinge fata.

Camionul nu este împins de mașină.



Este cîinele care mușcă pisica.

El o ține.

Fata este împinsă de băiat.

Băiatul nu este stropit de fată.

Un țăran a plecat cu calul lui la pădure să culeagă bureți. A cules trei duzini de bureți și le-a dus la târg. Le-a dat pentru un sac de mălai.

gară

plasă

riu

mere

cot

## COMPREHENSIONE DE CUVINTE CITITE

bară

1

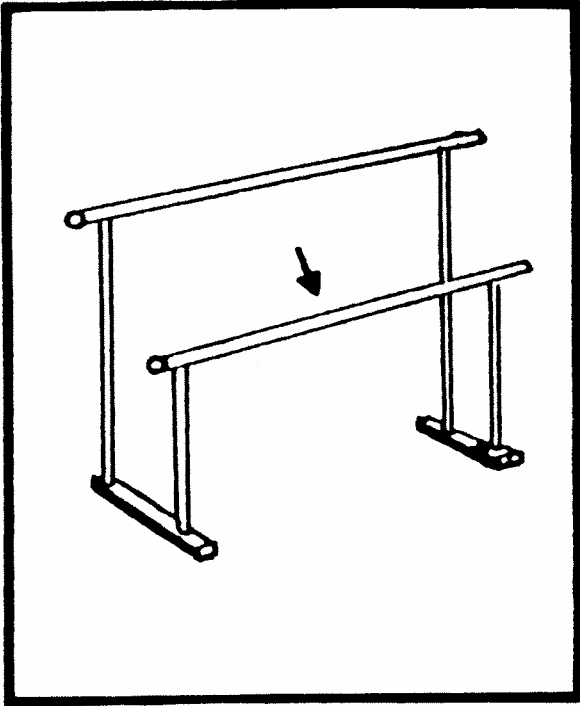

2

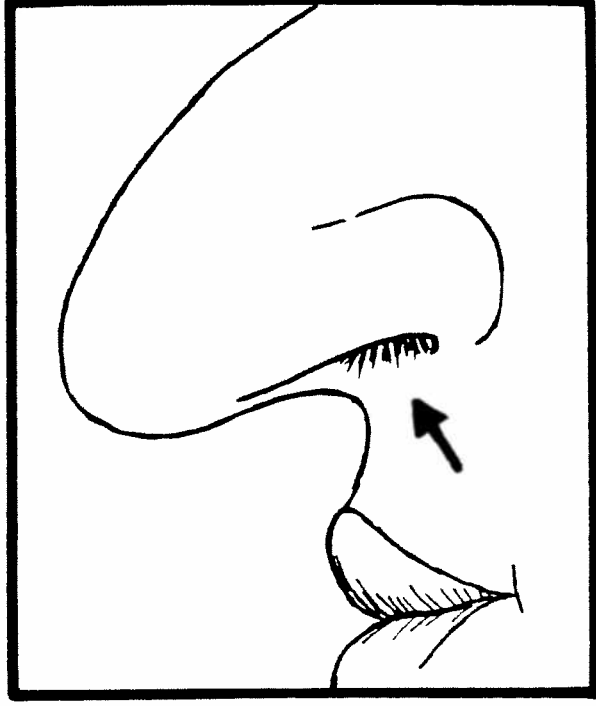

3

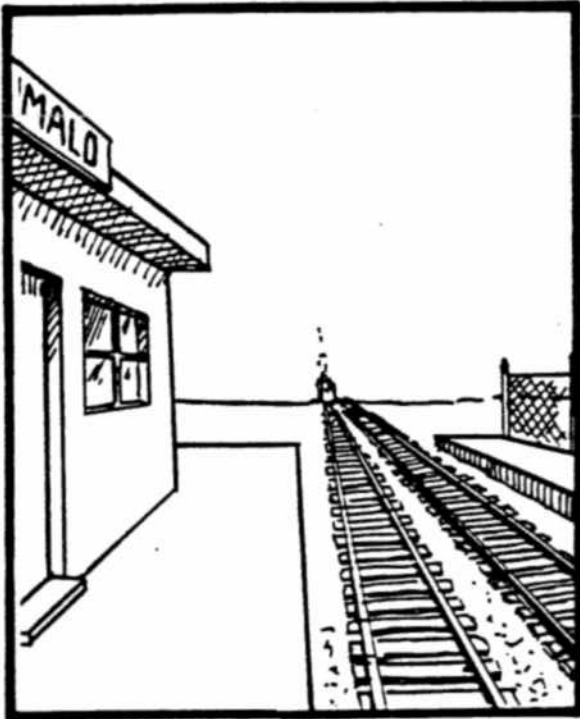

4

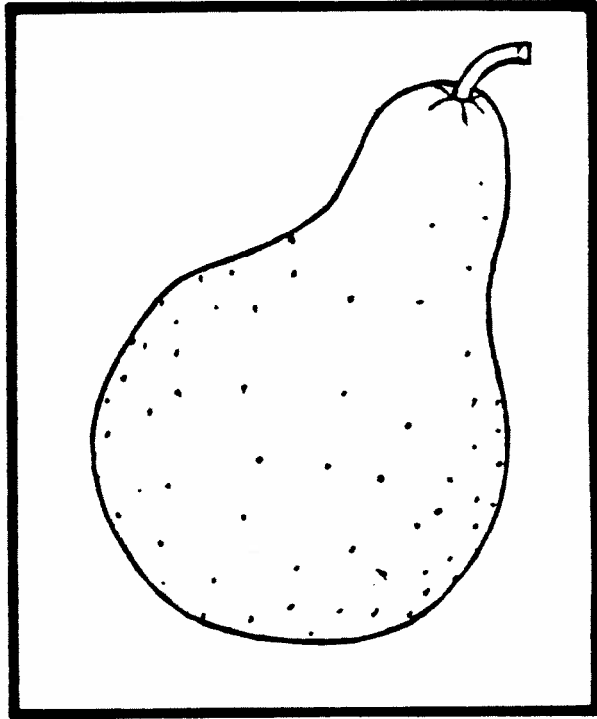

**muc**



1

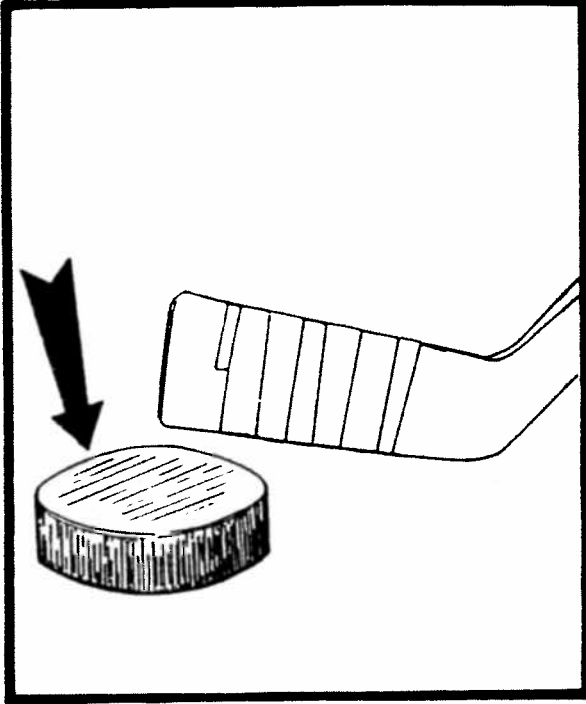

2

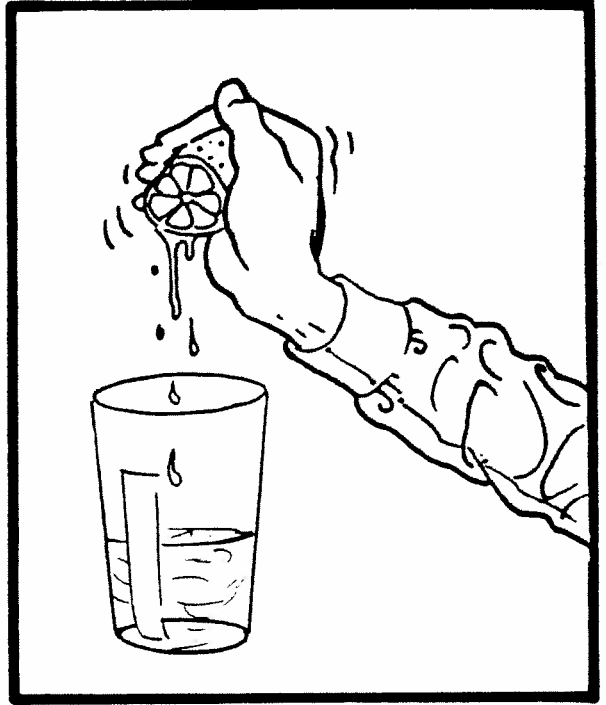

3

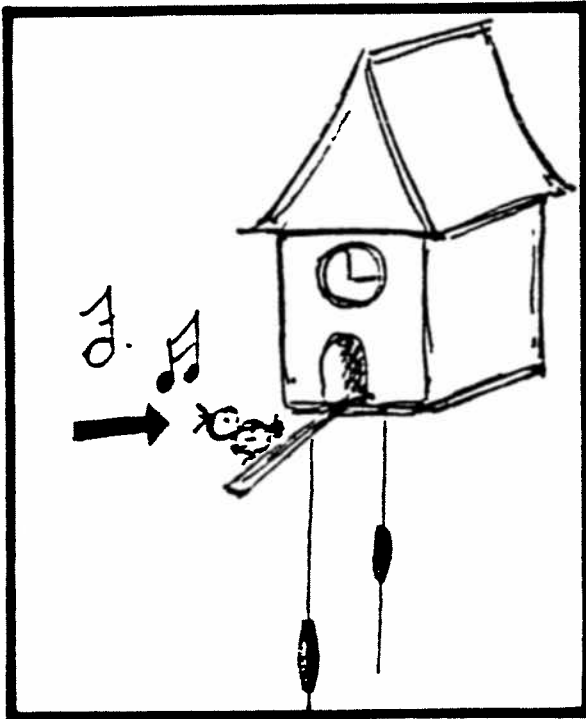

4

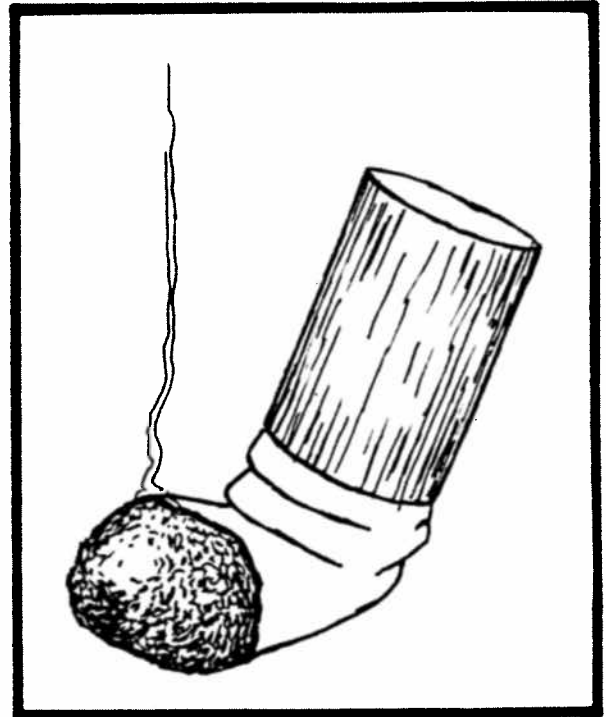

fină

1

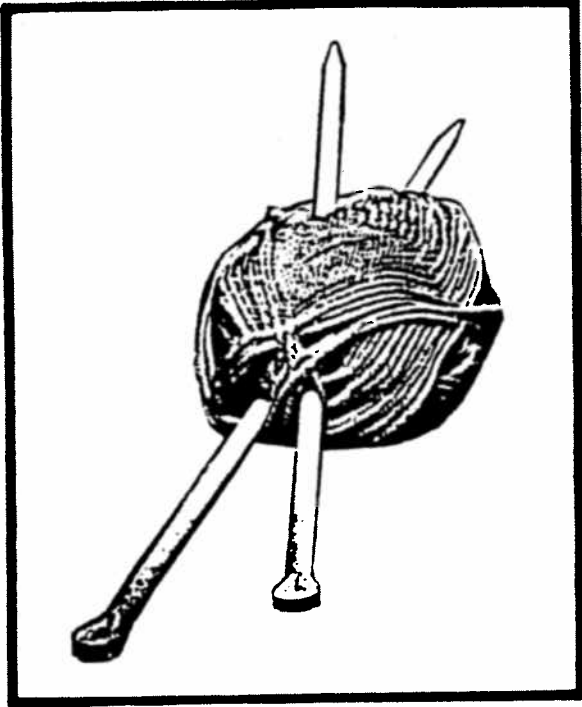

2

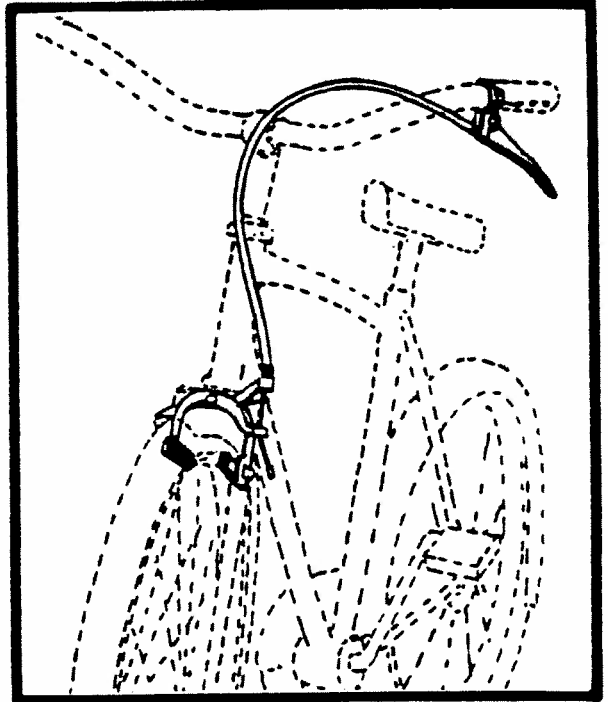

3

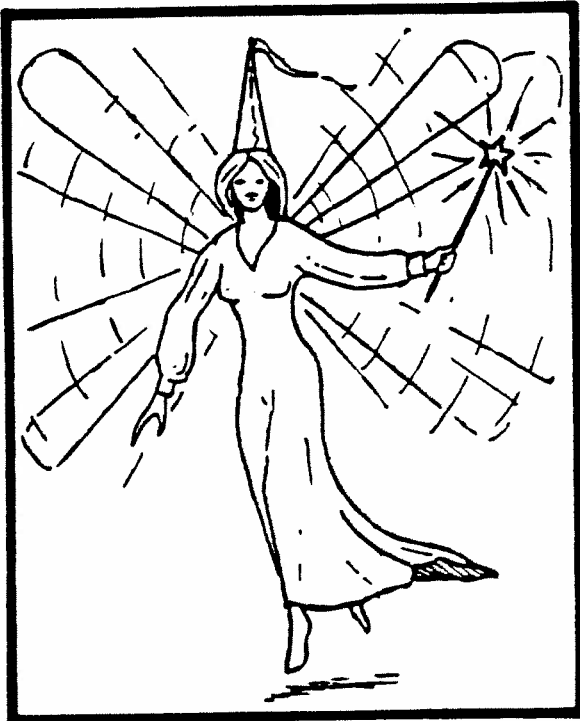

4

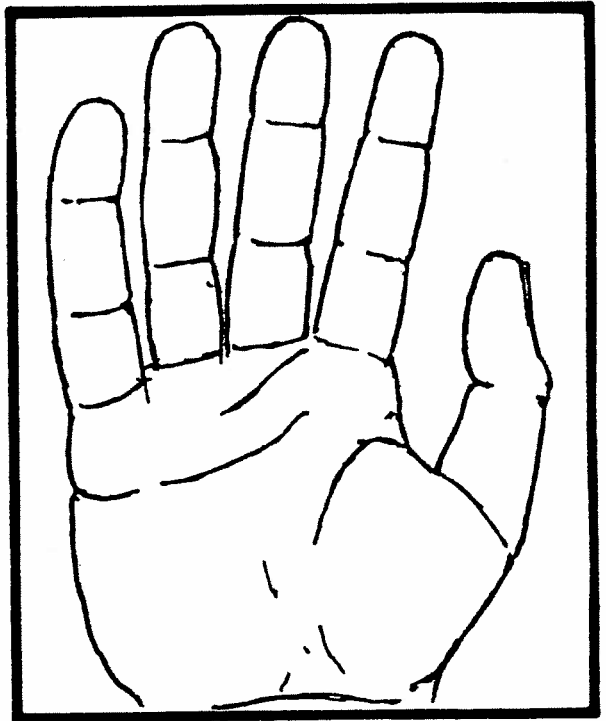

ramă

1

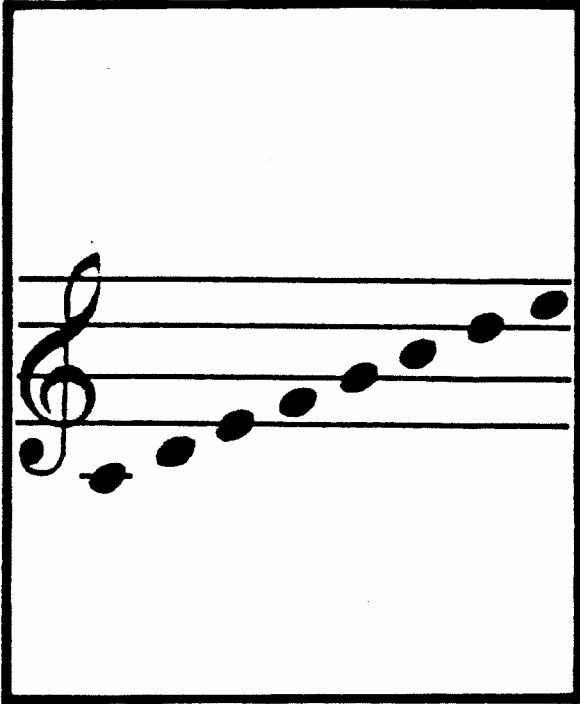

2

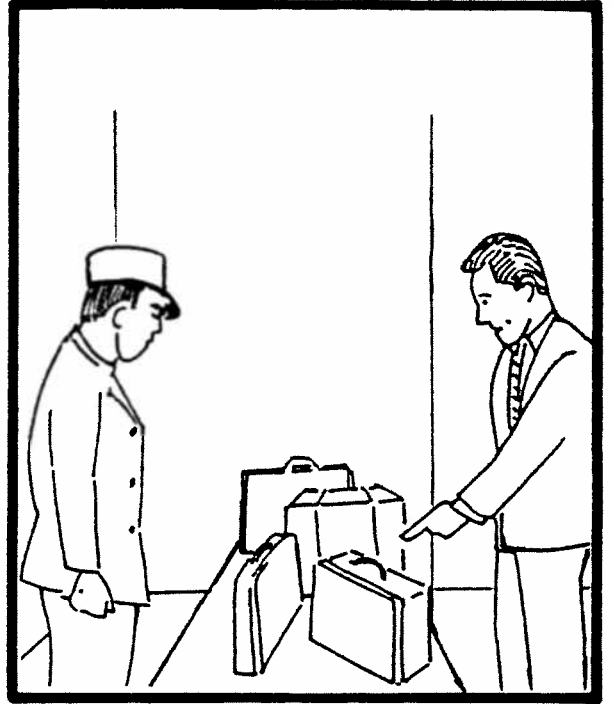

3

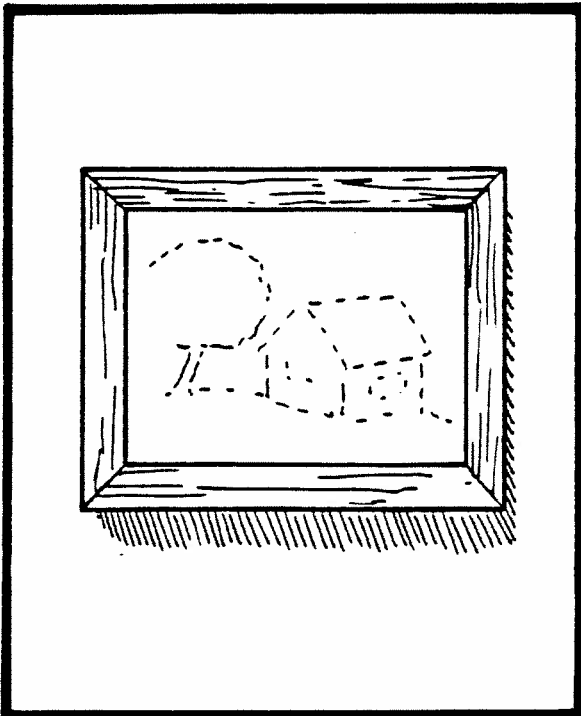

4

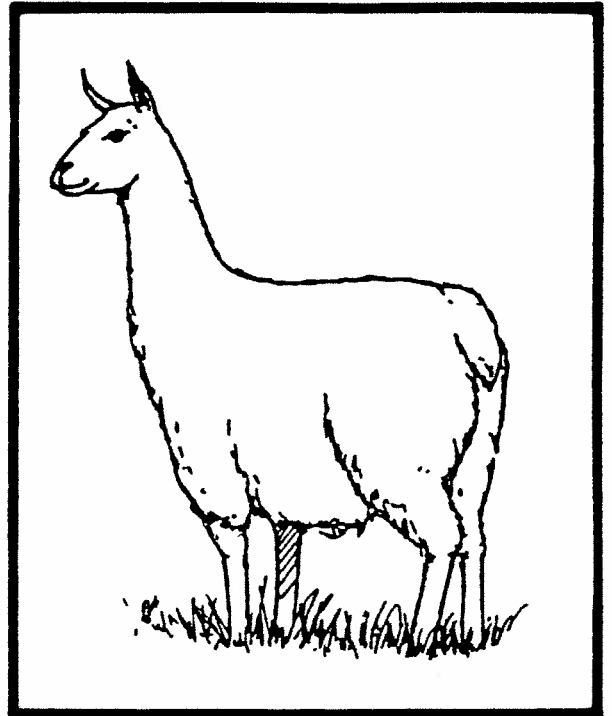

lac

1

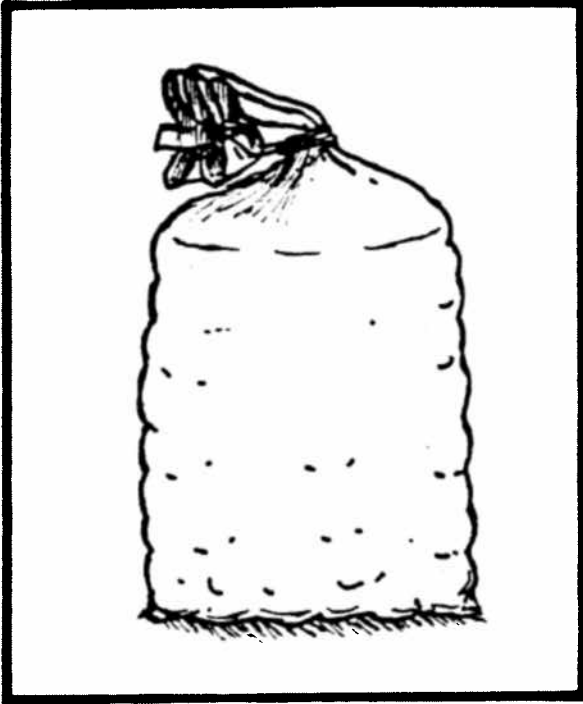

2

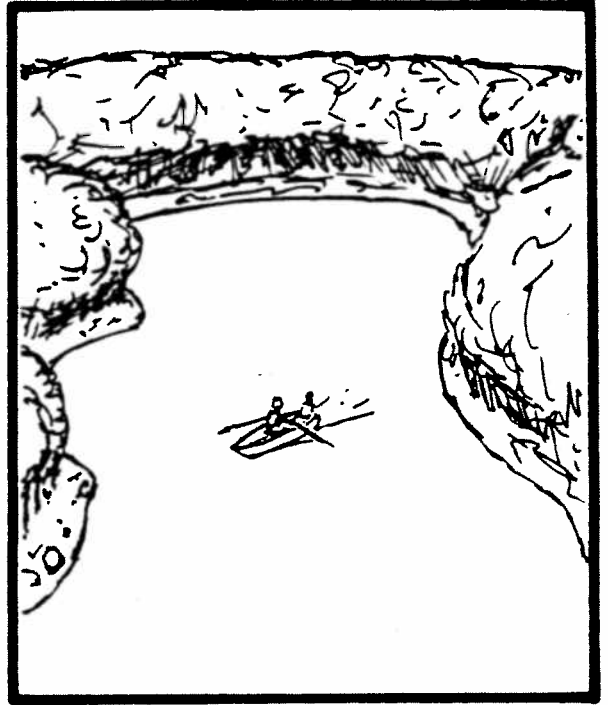

3

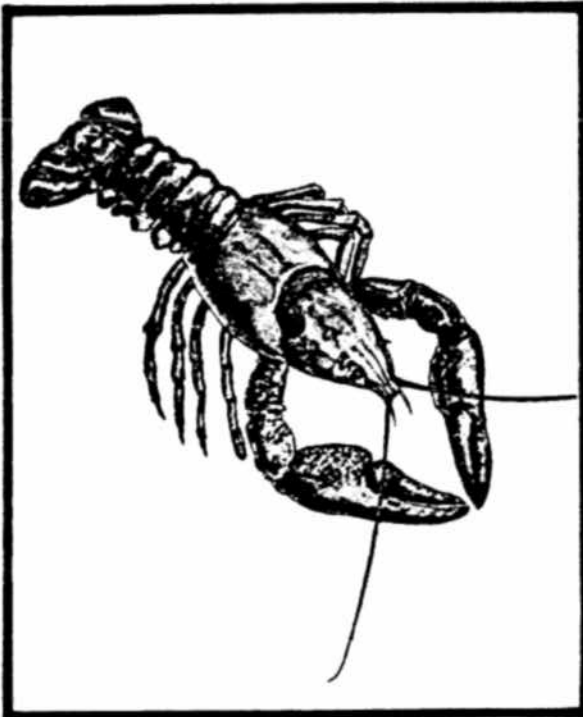

4



**sar**



1



2

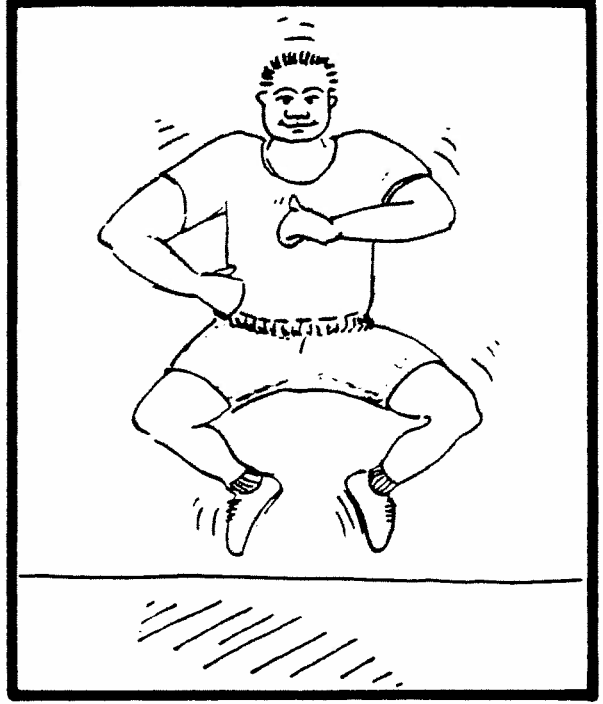

3

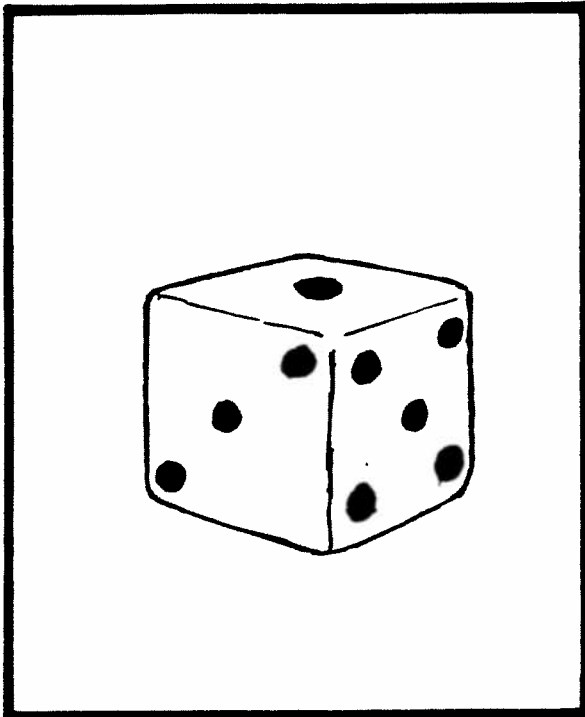

4

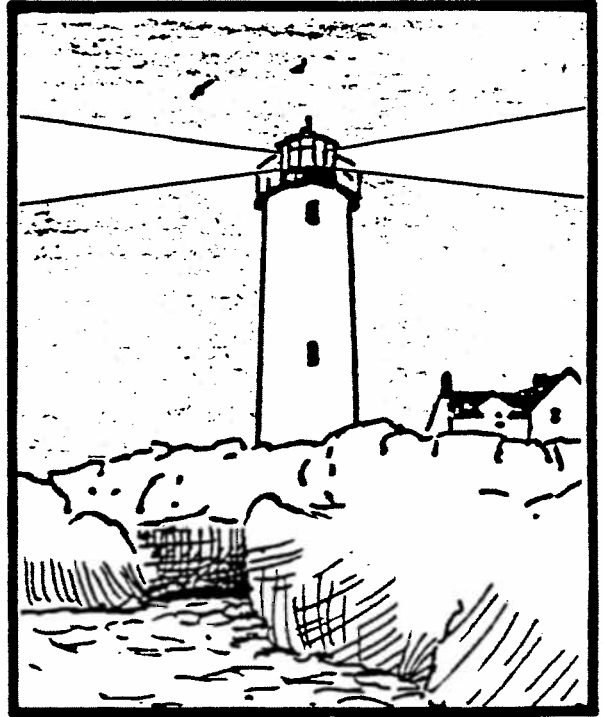

şal

1

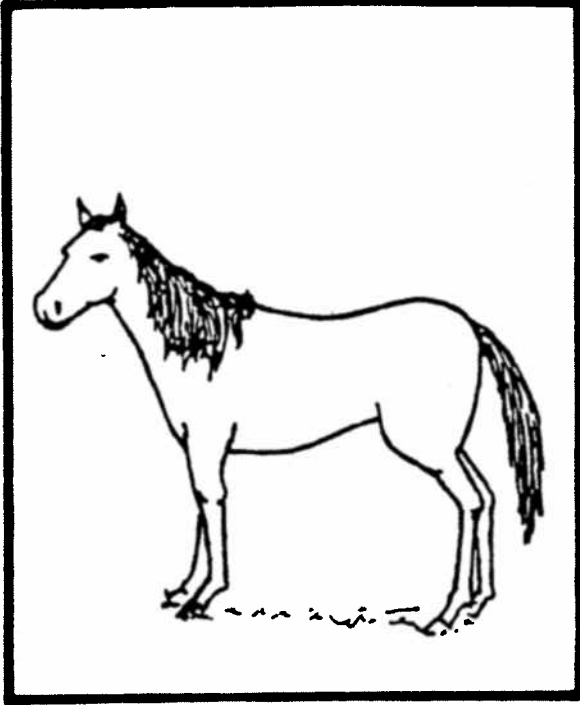

2



3

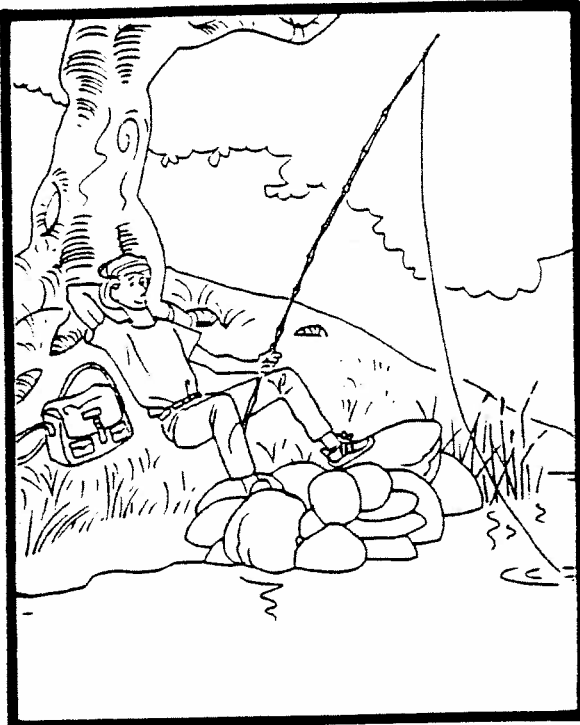

4

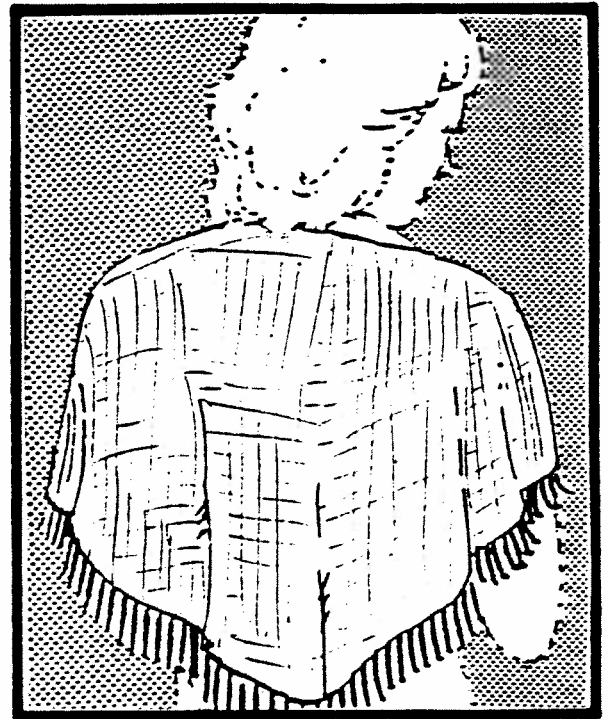

brîu

1

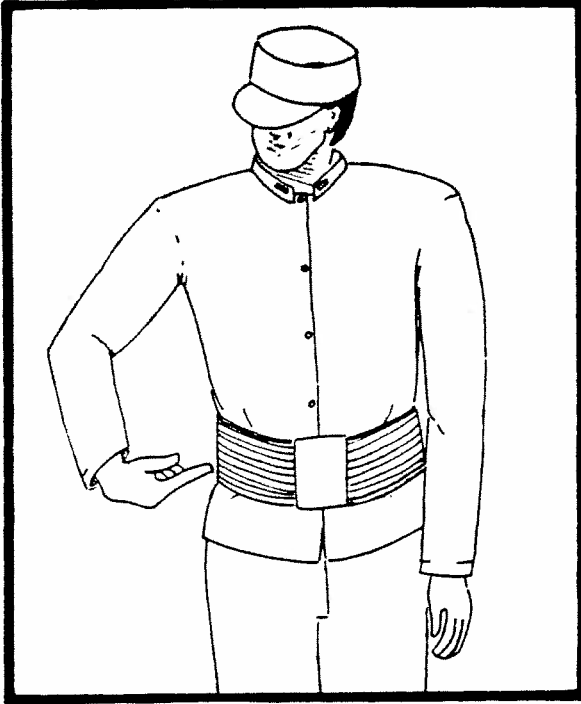

2

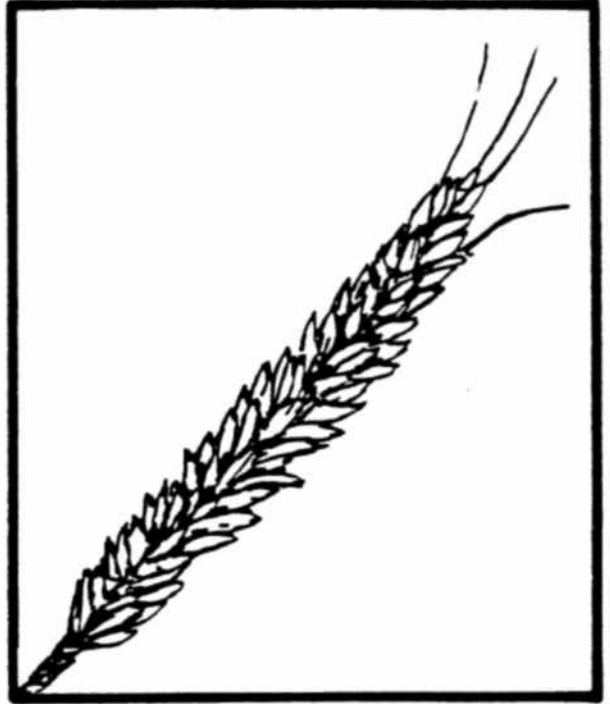

3



4

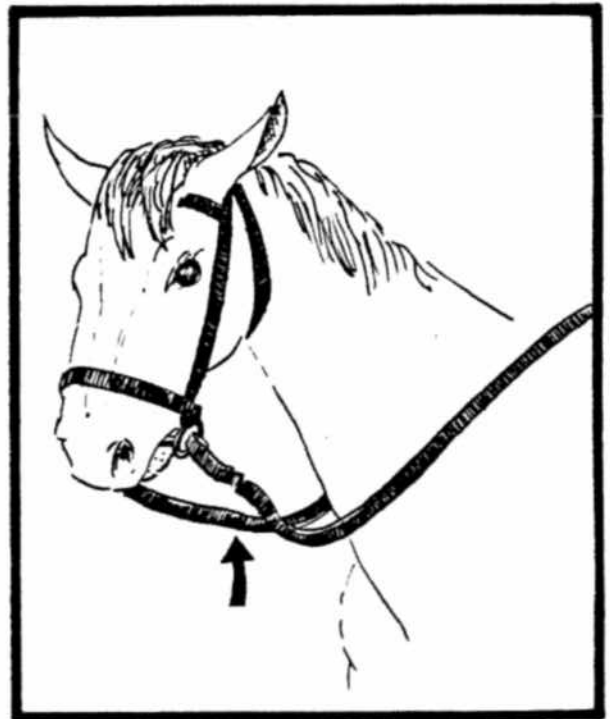

**fir**

1

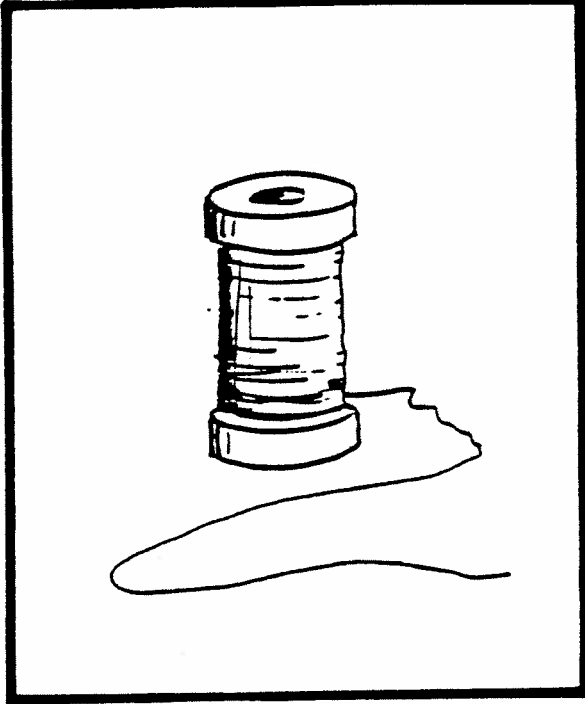

2

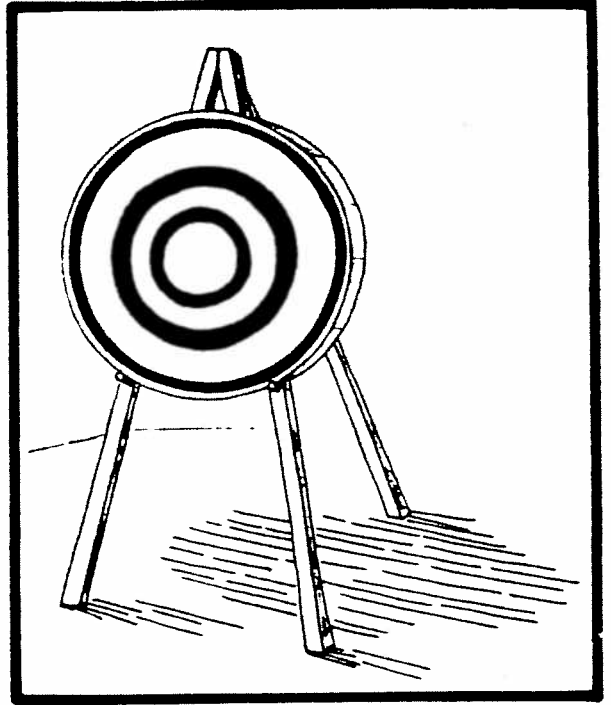

3



4



pere



1

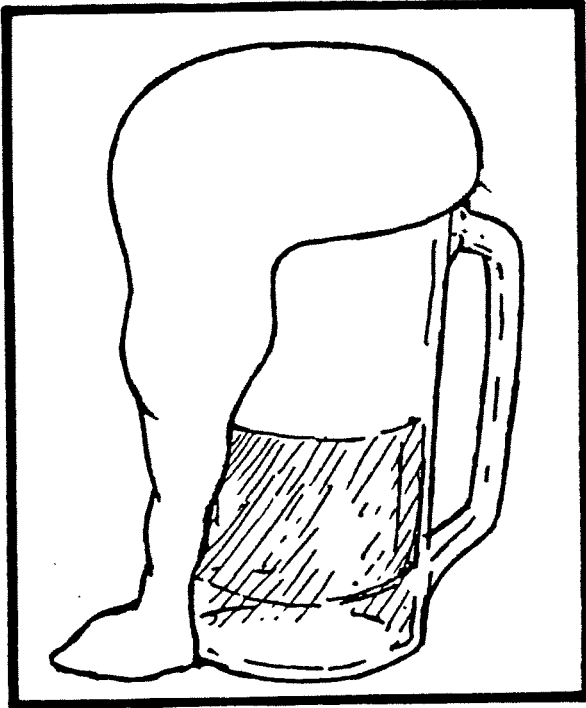

2

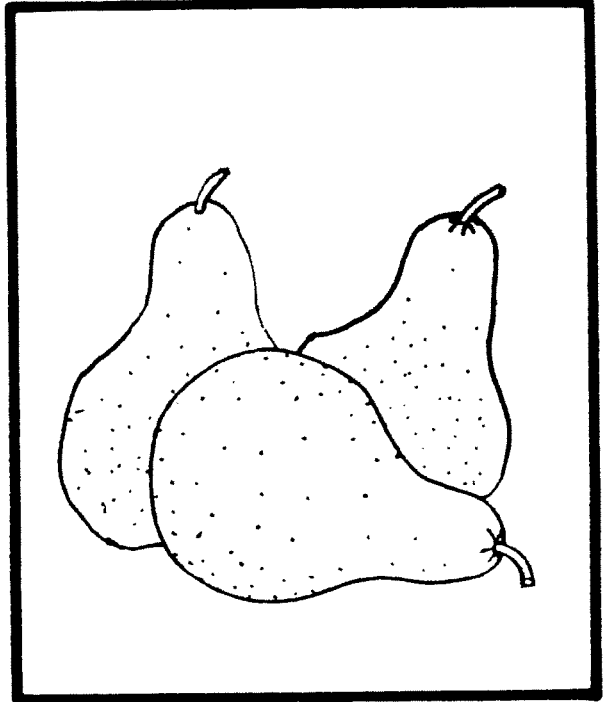

3

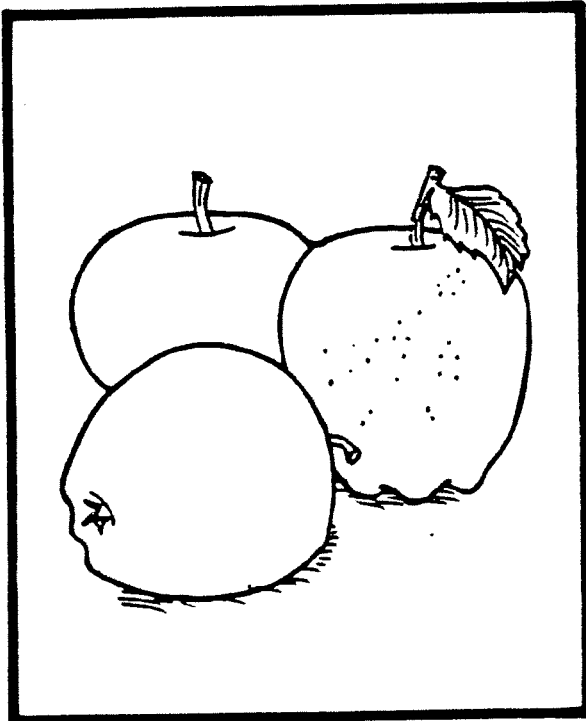

4

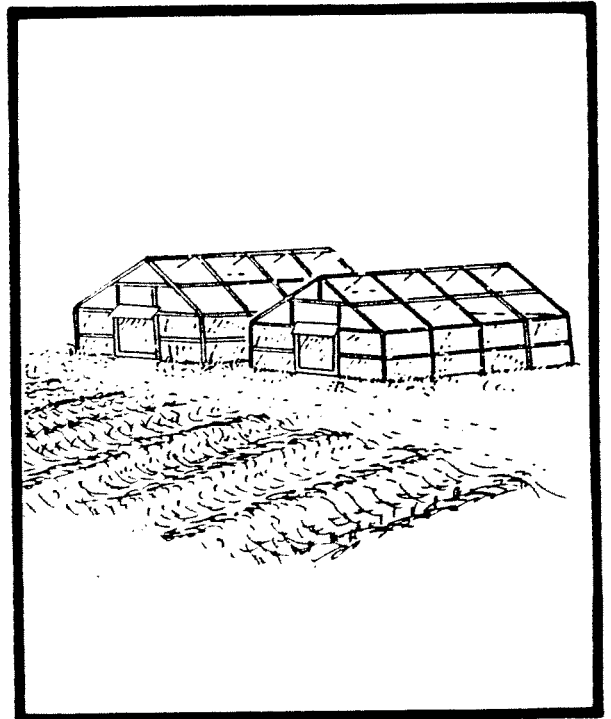



## COMPREHENSIONE DE FRAZE CITITE

Băiatul ține fata.

1

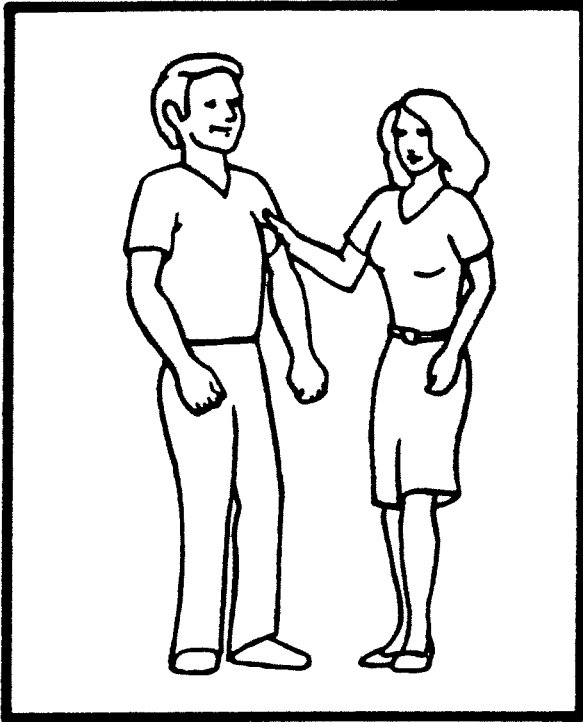

2

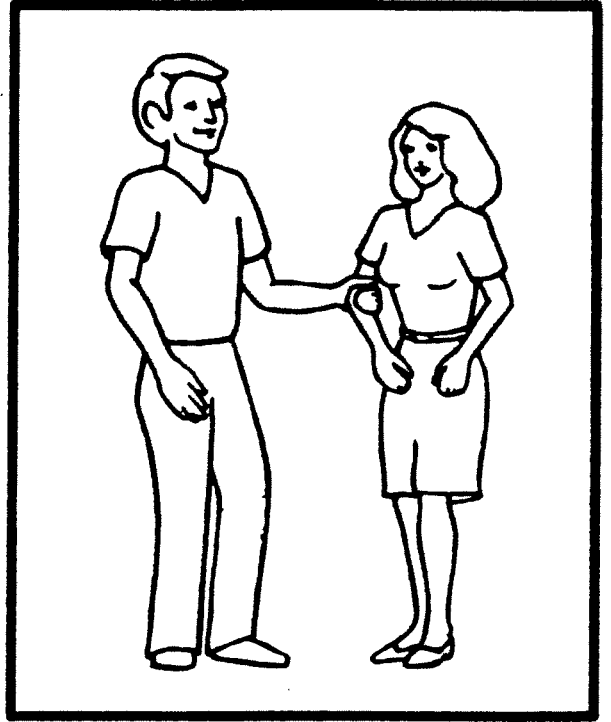

3

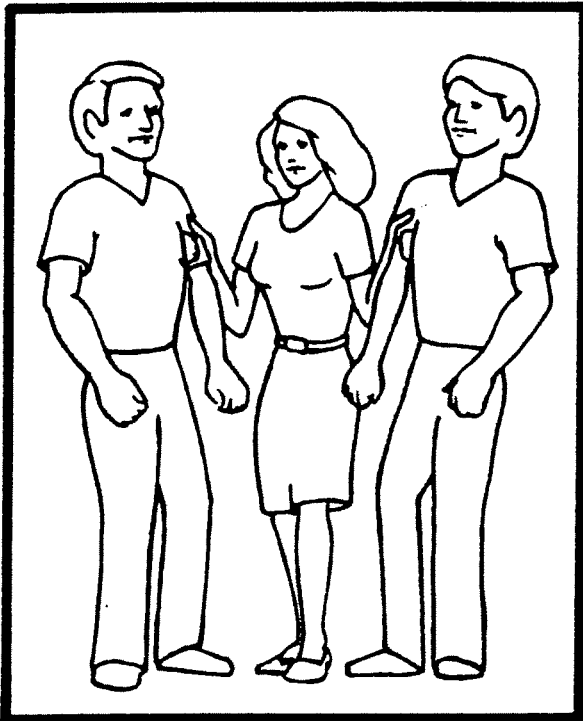

4

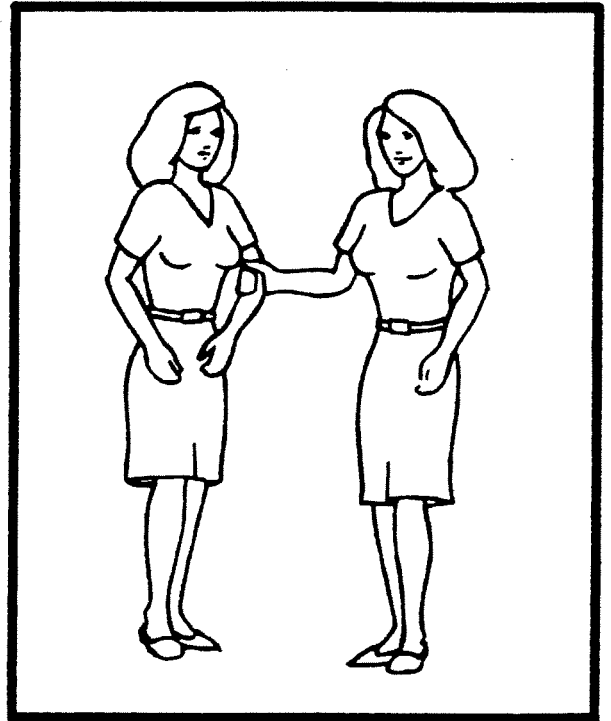

Ea îl împinge.

1

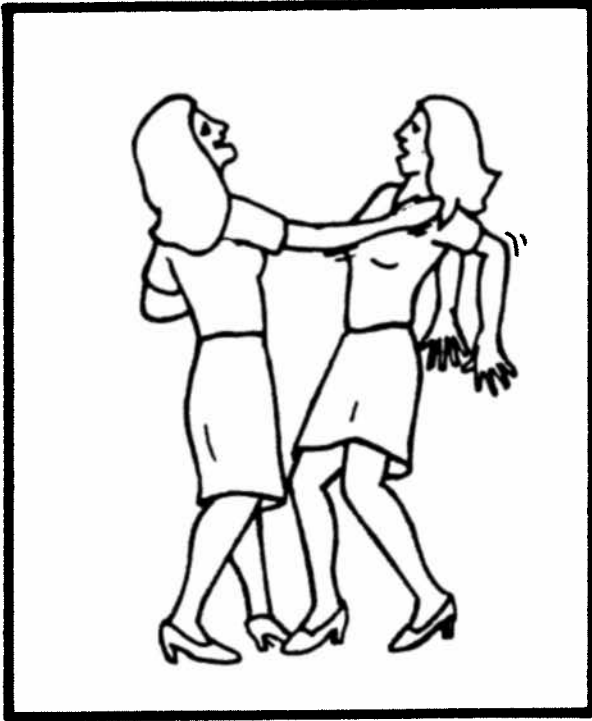

2

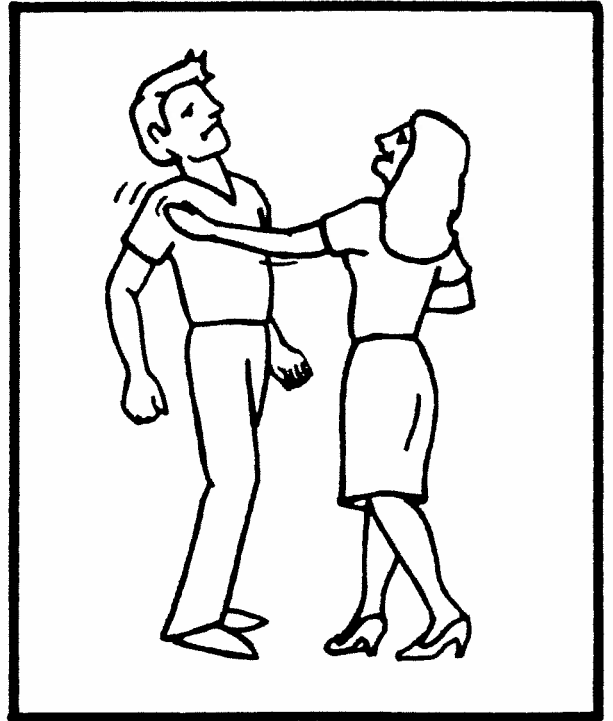

3

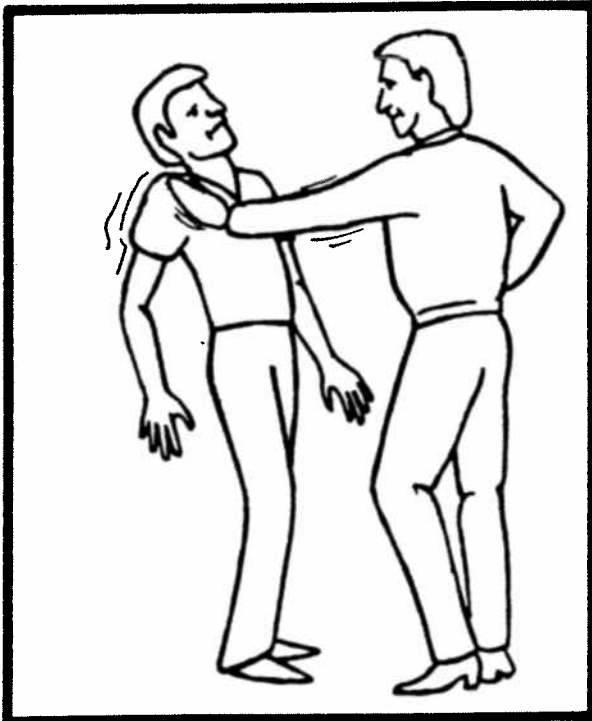

4

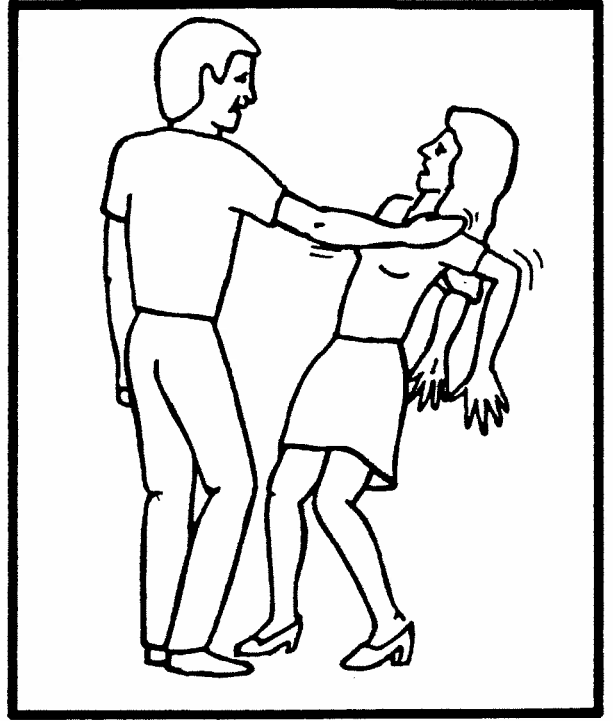

Ciinele este mușcat de pisică.



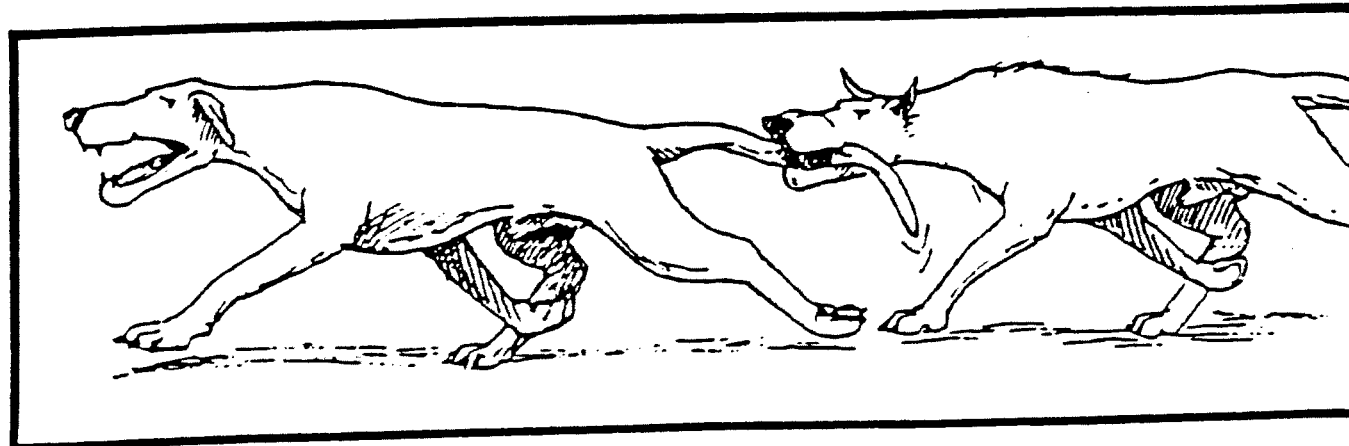
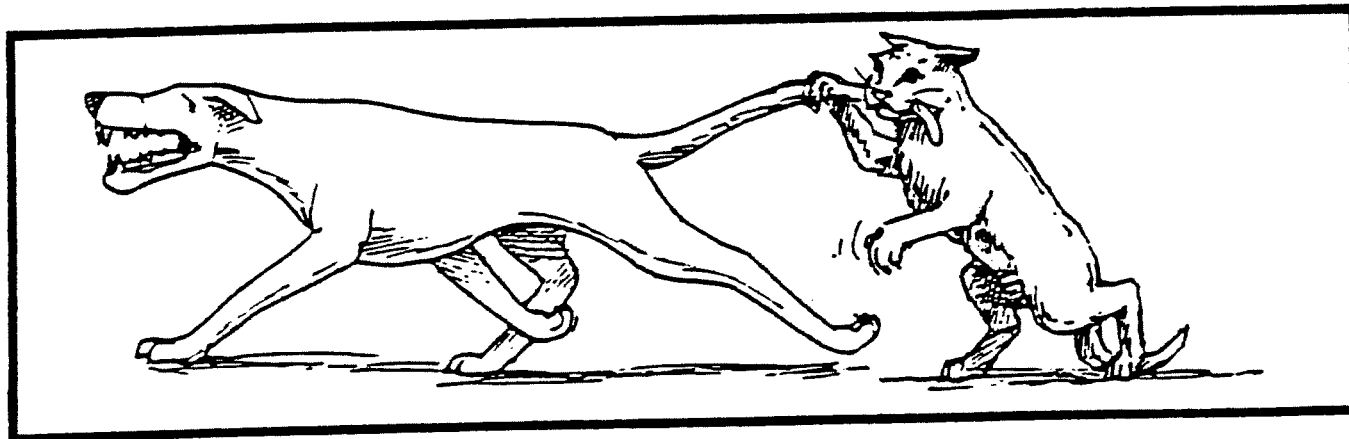
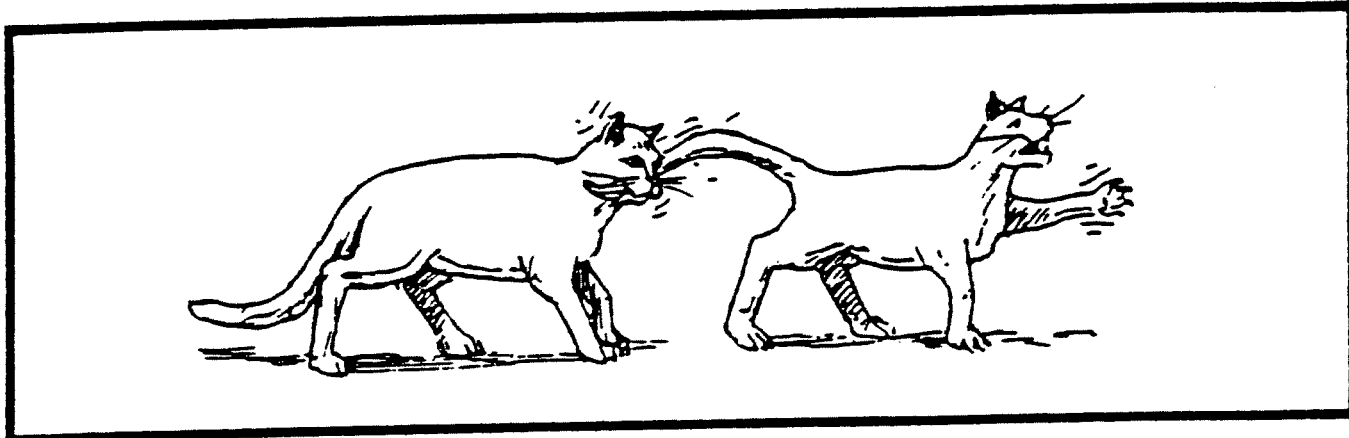
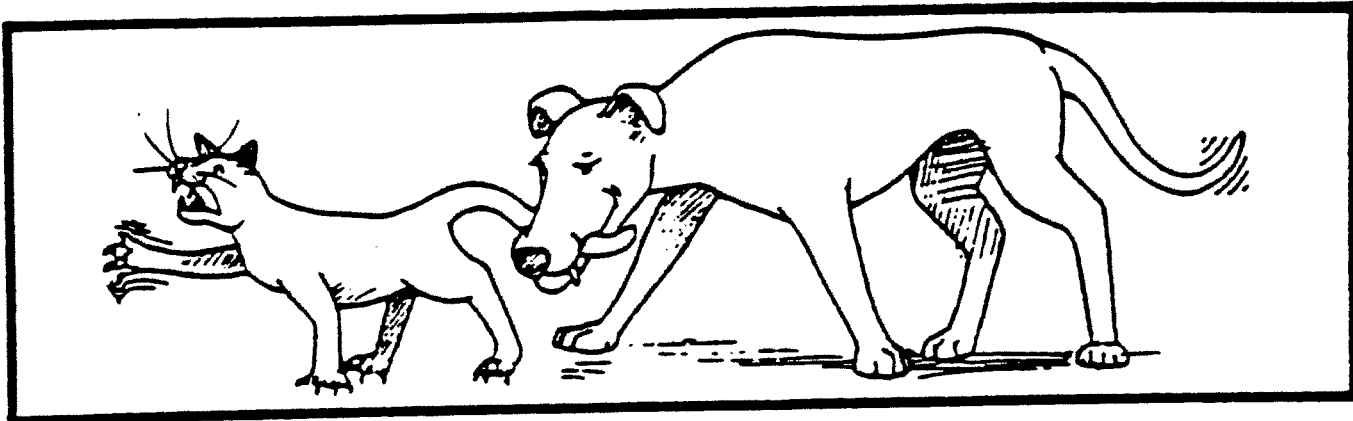

Este camionul care trage mașina.

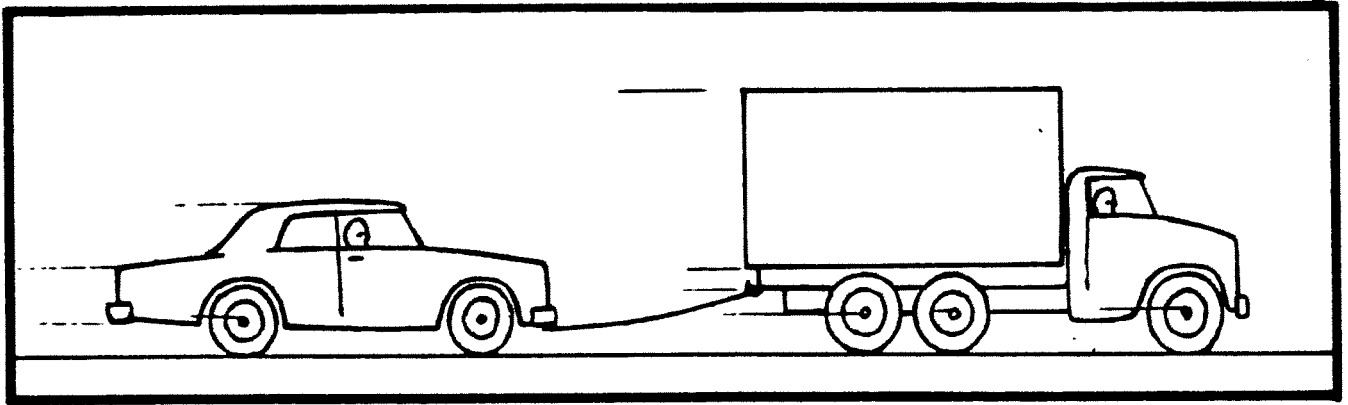

2

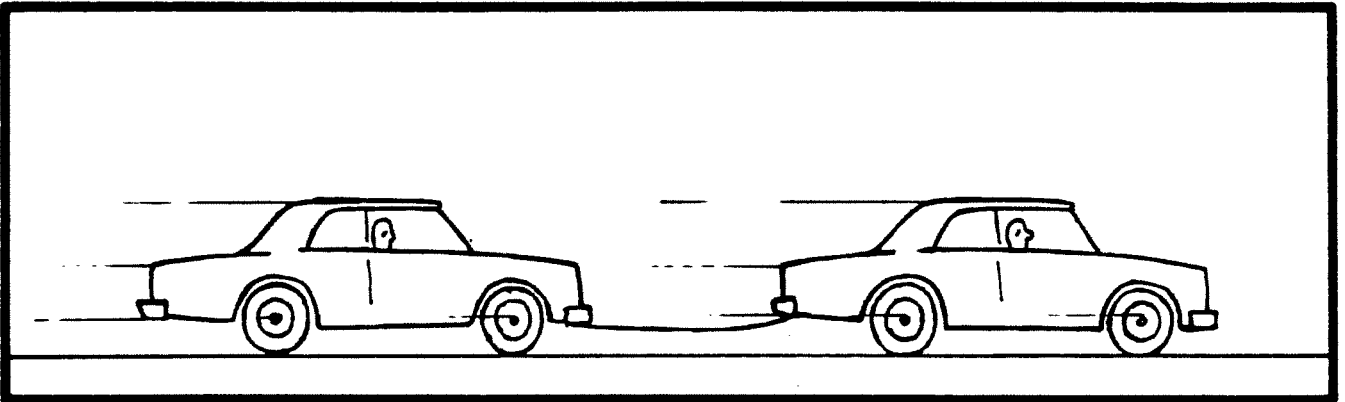

3

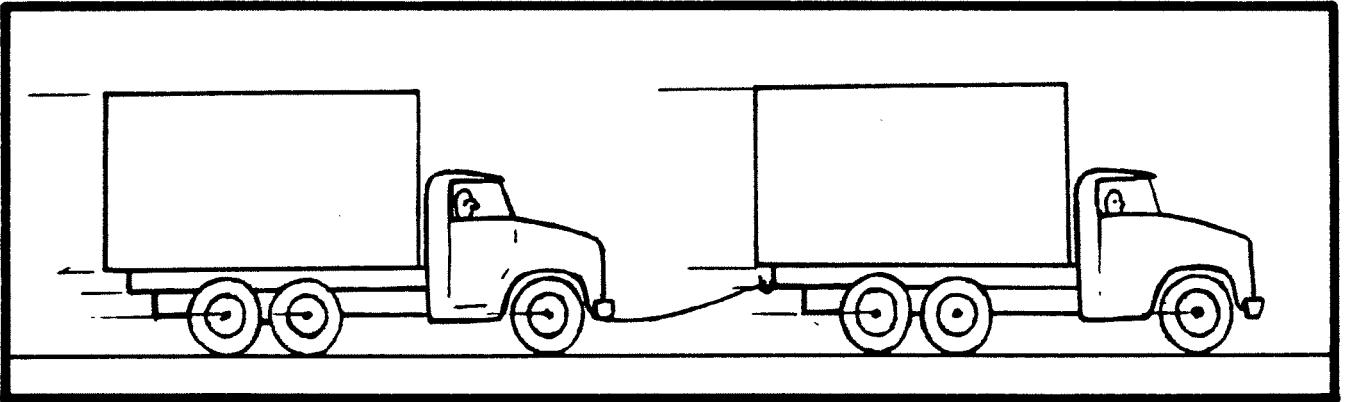

4

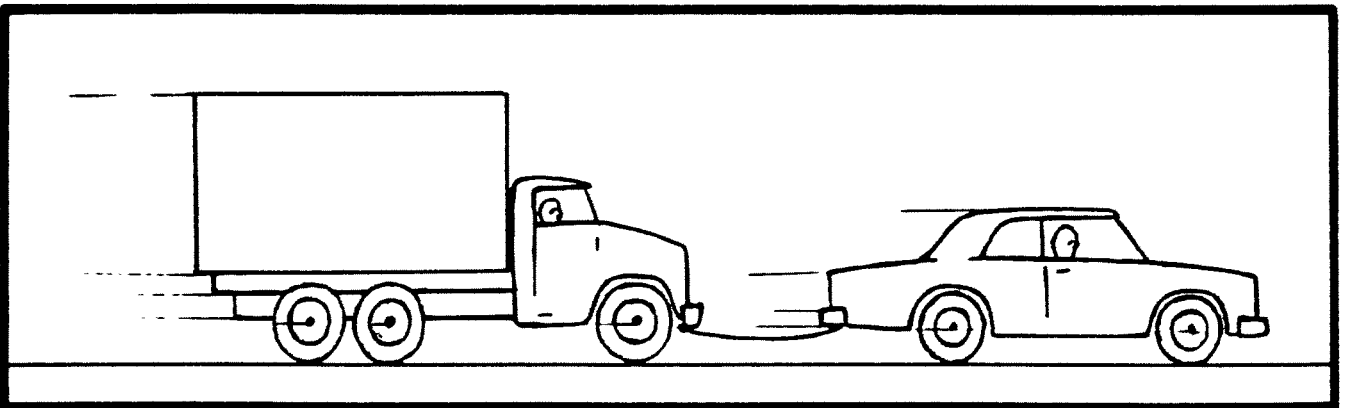

Băiatul nu împinge fata.

1

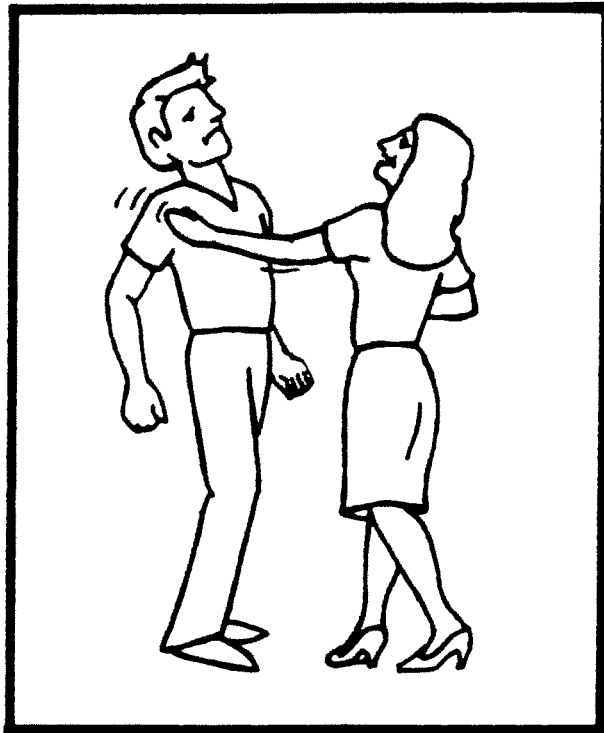

2

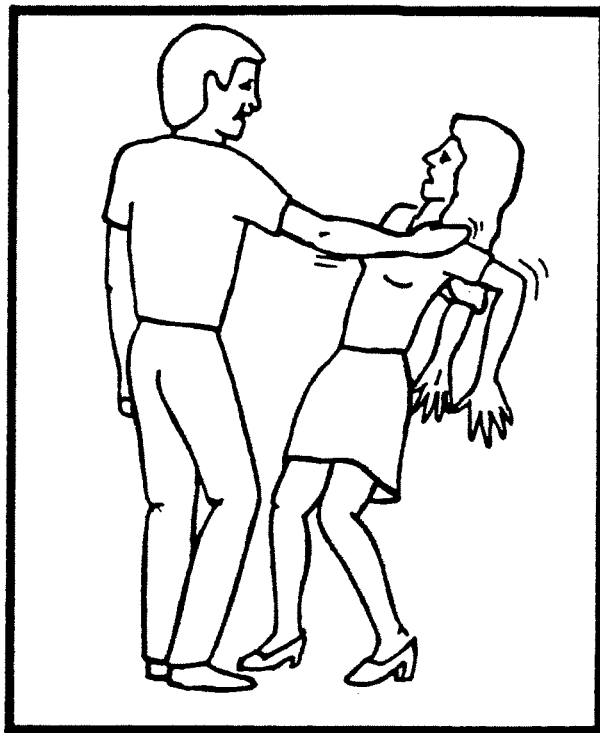

Camionul nu este tras de mașină.

1

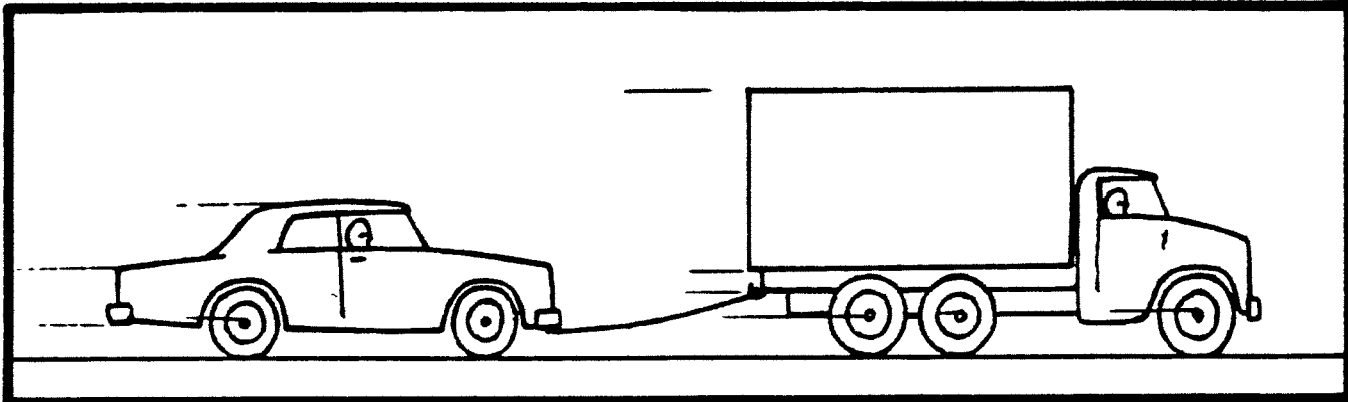

2

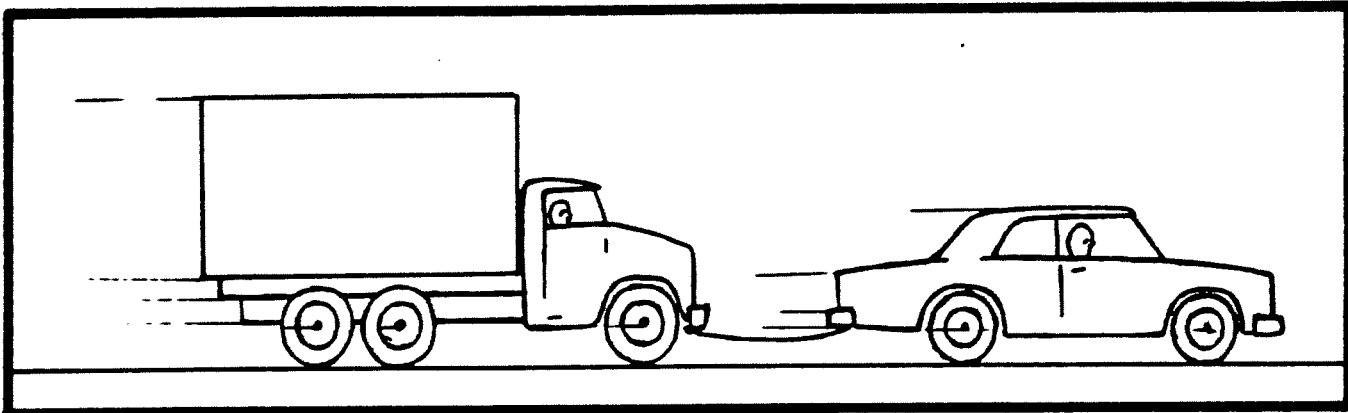

Este cîinele pe care îl mușcă pisica.



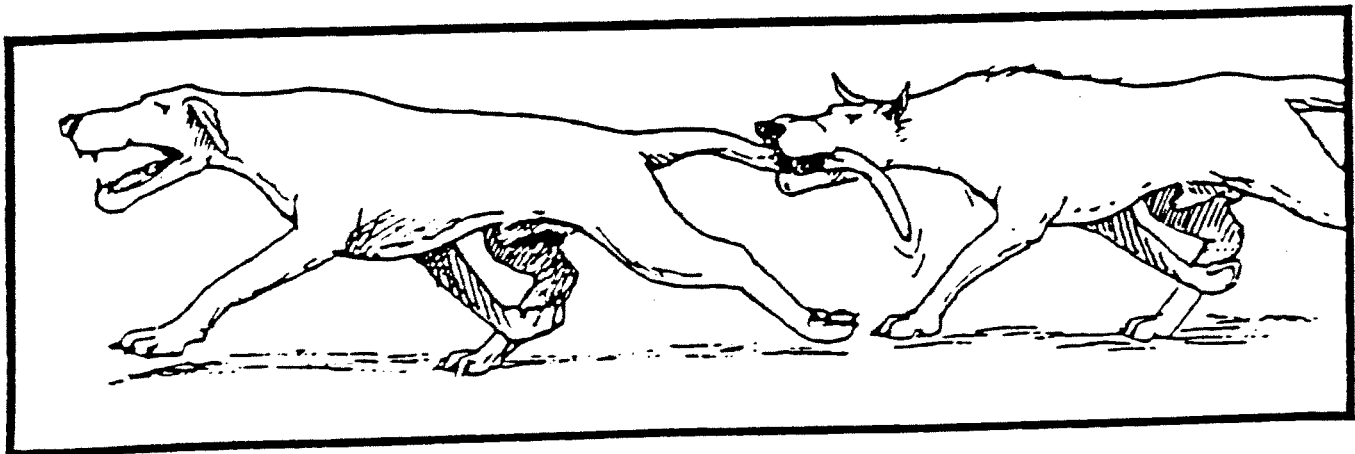
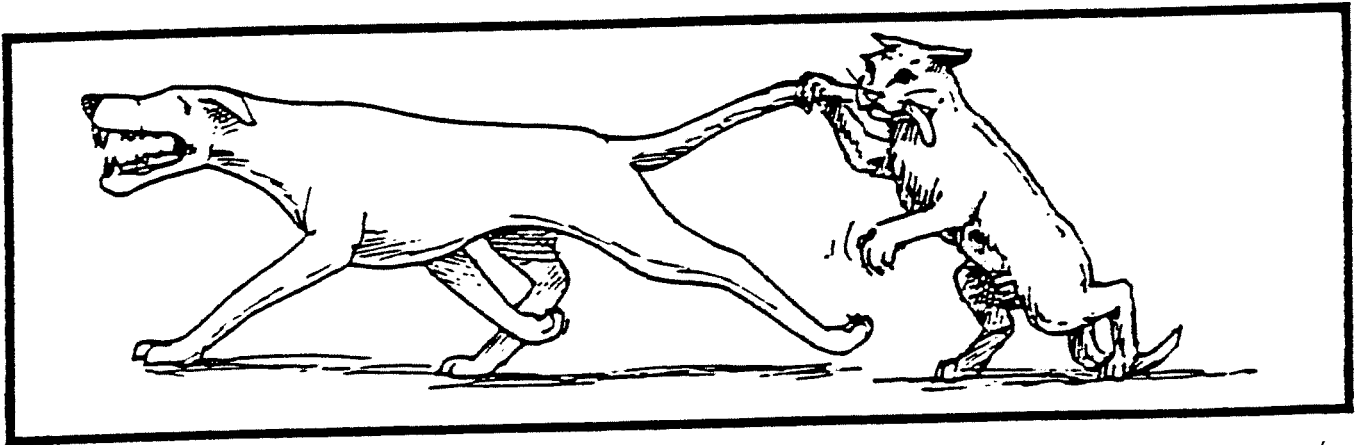
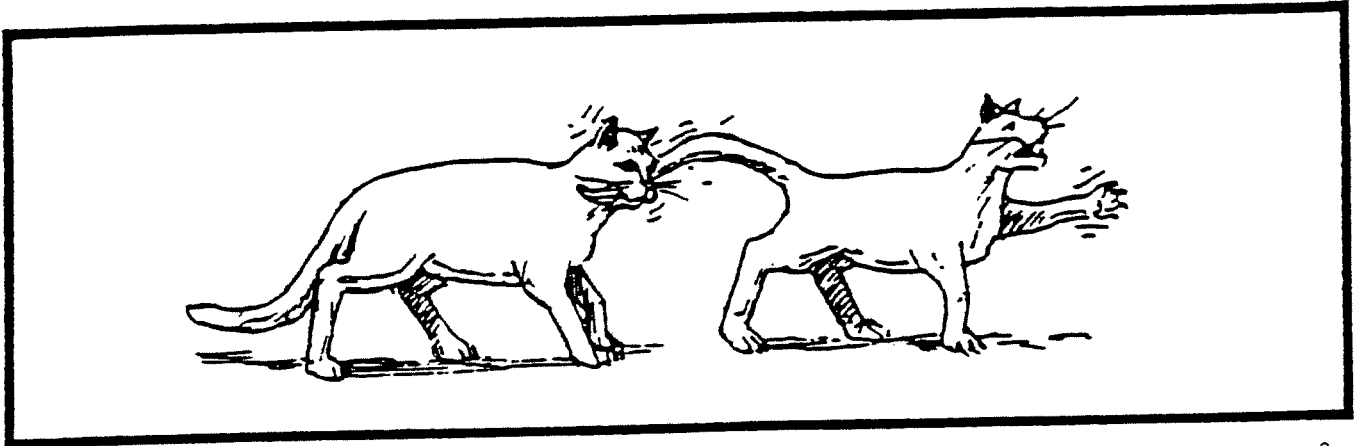
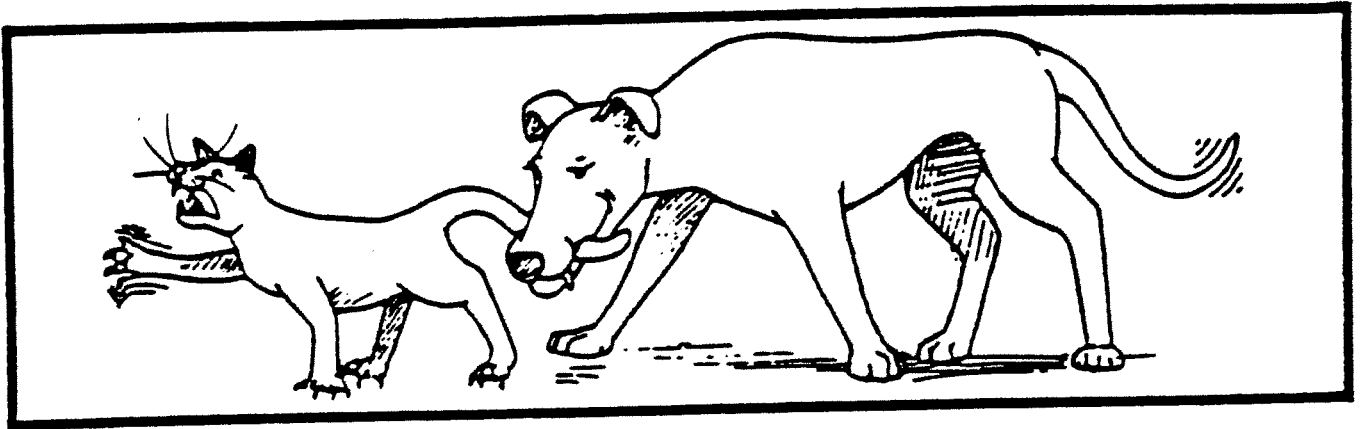

El o ține.

1



2

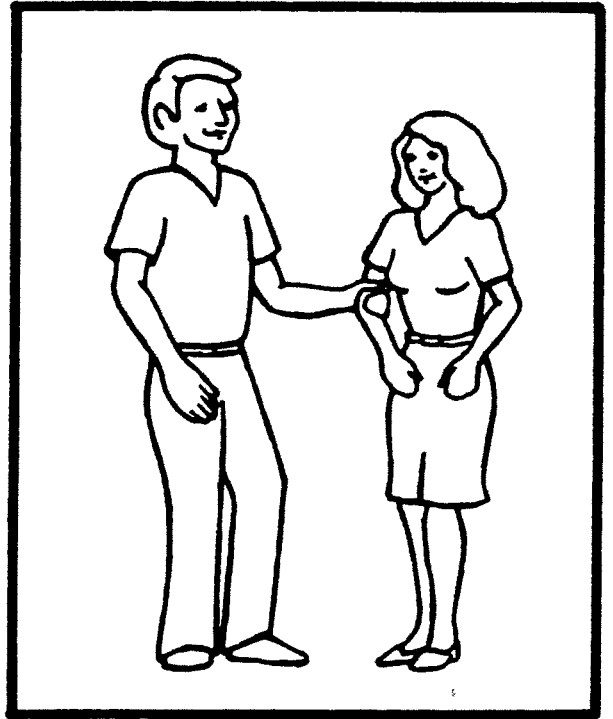

3

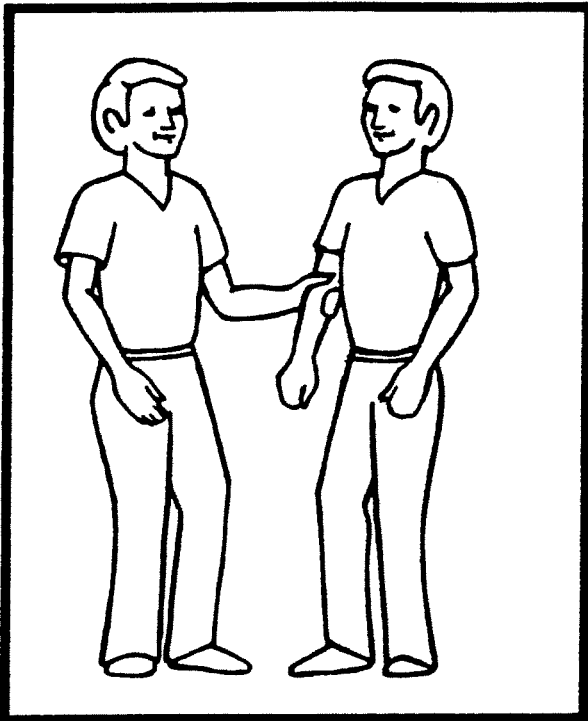

4



Fata este împinsă de băiat.

1

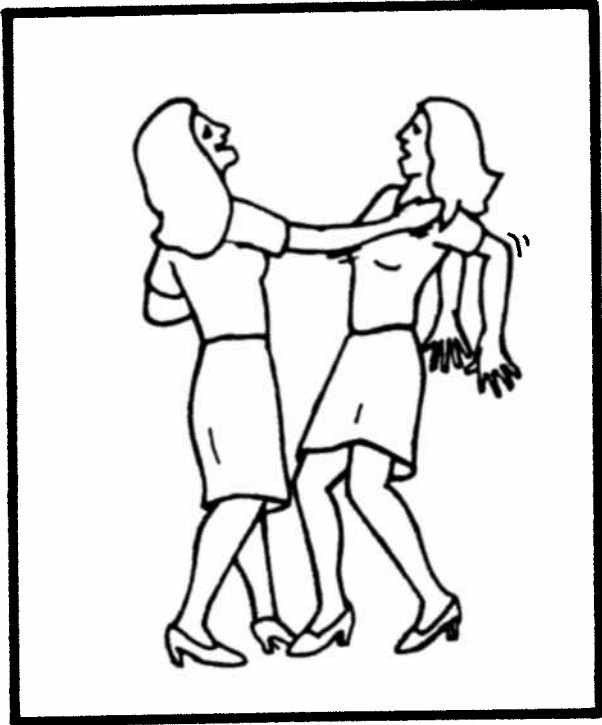

2

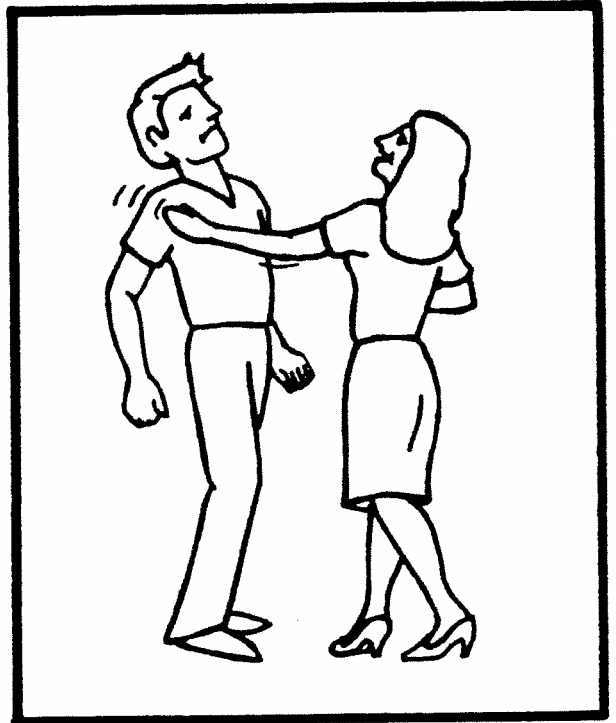

3

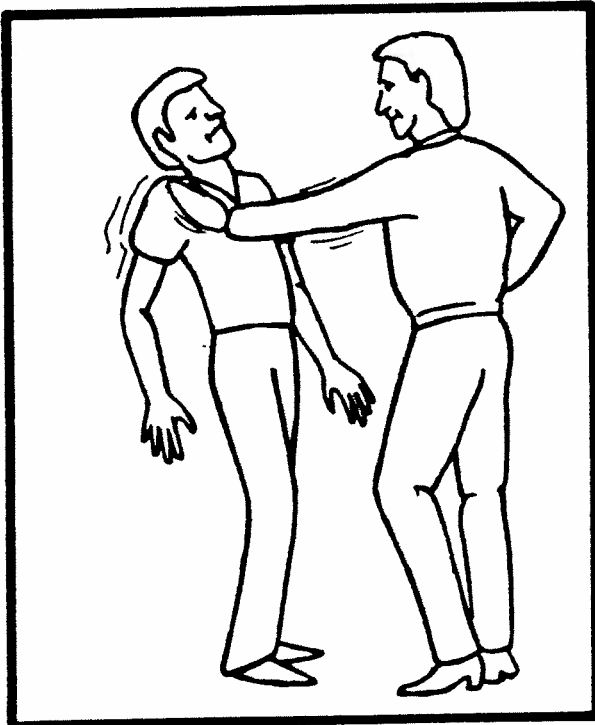

4

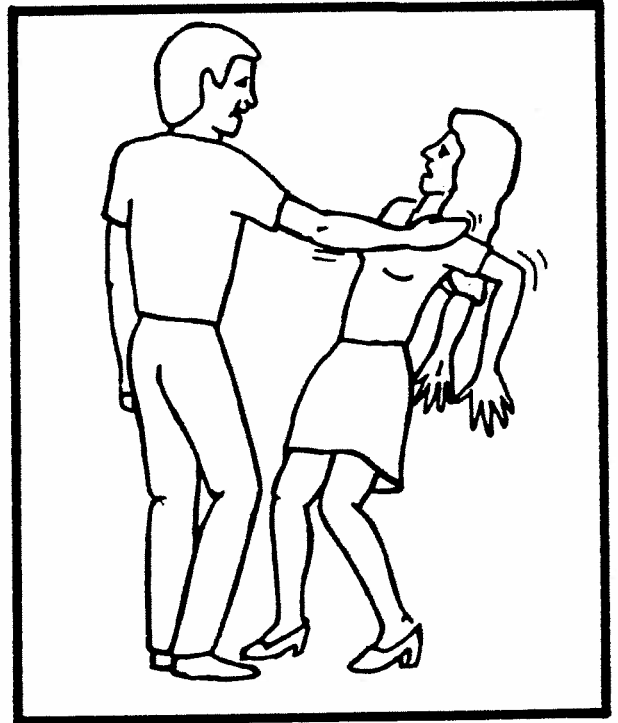

Fata nu este stropită de băiat.

1

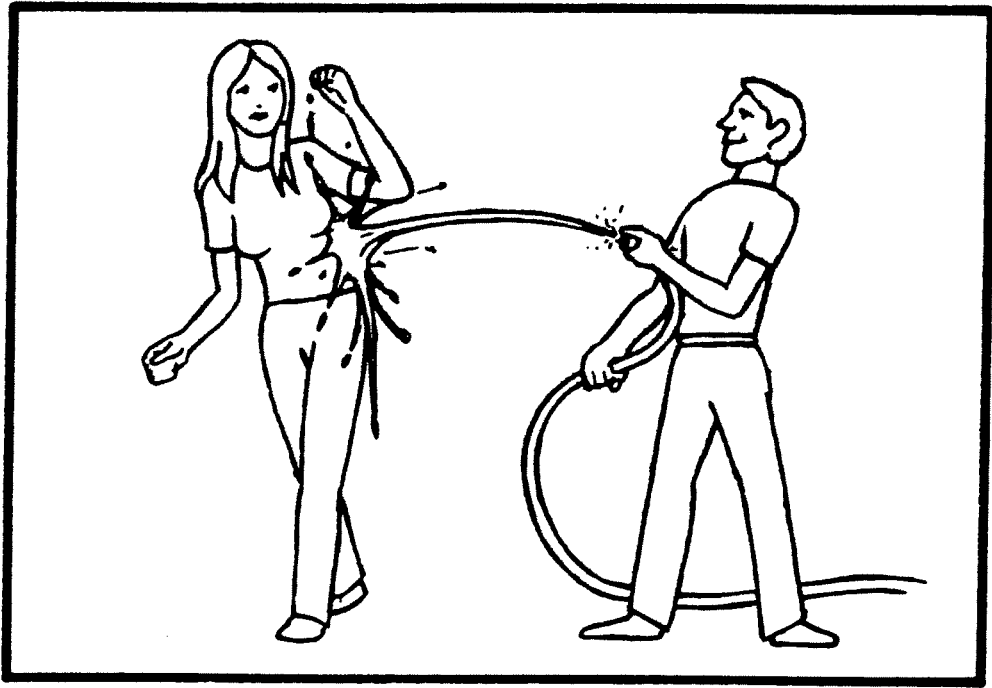

2

