

Michel Paradis
McGill University

BILINGUAL APHASIA TEST
(ITALIAN VERSION)

STIMULUS BOOK

ITALIANO

The development of the Bilingual Aphasia Test materials was supported by Grant MEQ 01-07-k (1976-1983) from the Quebec Ministry of Intergovernmental Affairs, Grant EQ 1660 (1980-1985) from the Quebec Ministry of Education FCAC Fund, and Grants 410-83-1028 (1984, 1985) and 410-88-0821 (1989-1991) from the Social Sciences and Humanities Research Council of Canada.

DISCRIMINAZIONE Uditiva Verbale

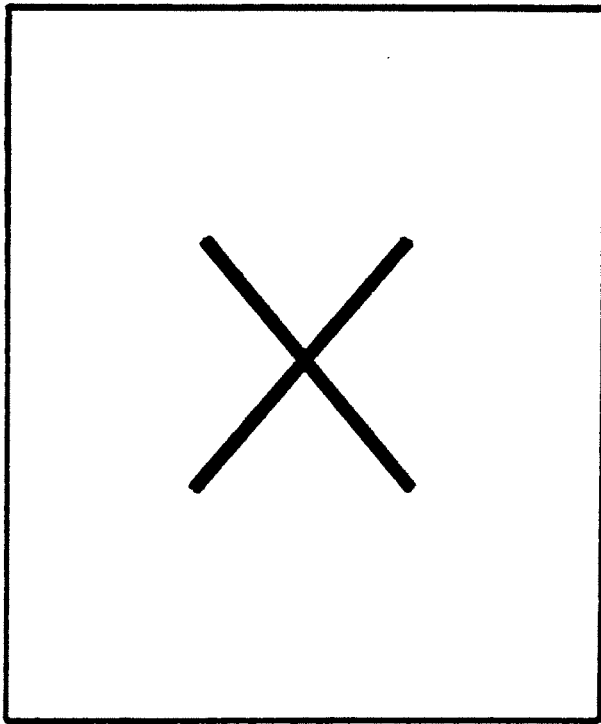

1

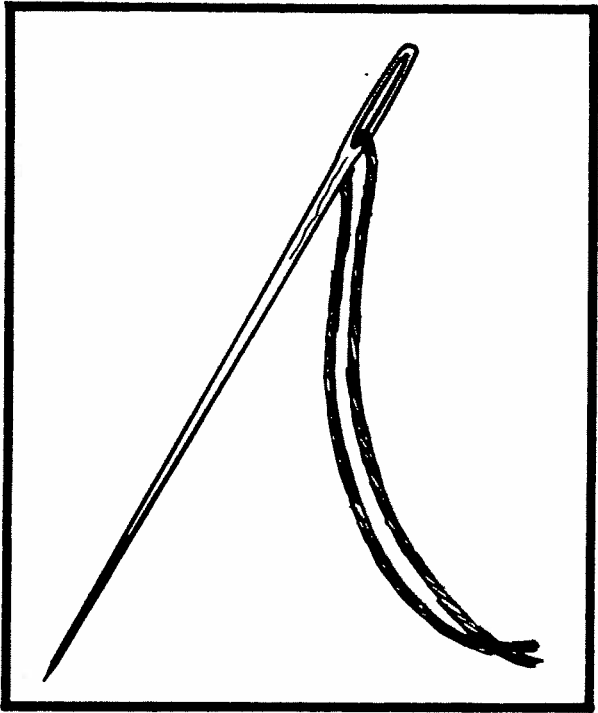

2



3

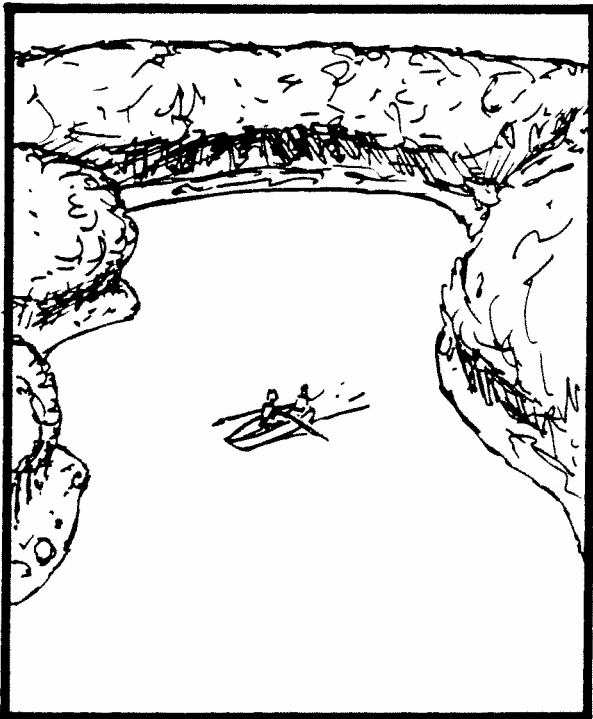

4

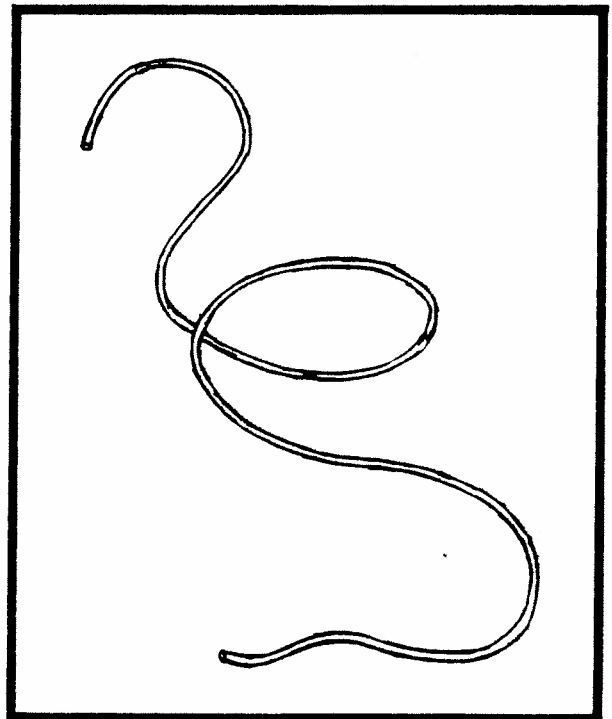

Esempio

1



2

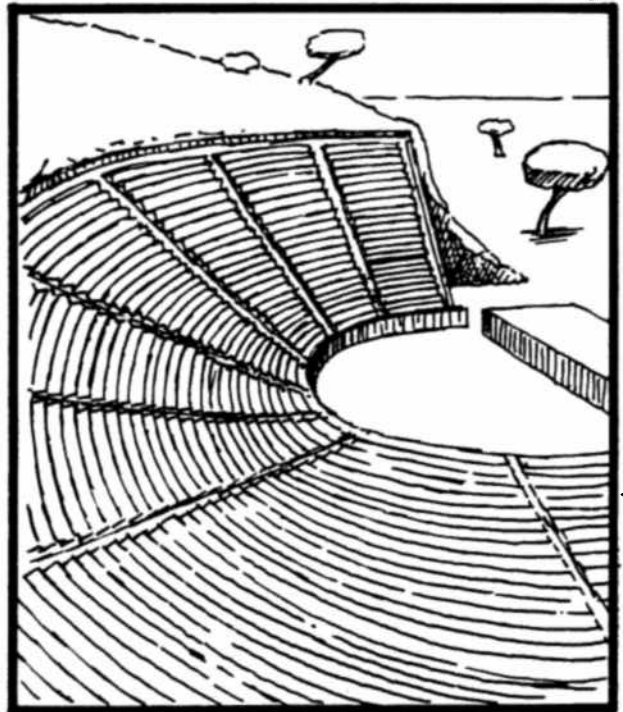

3



4

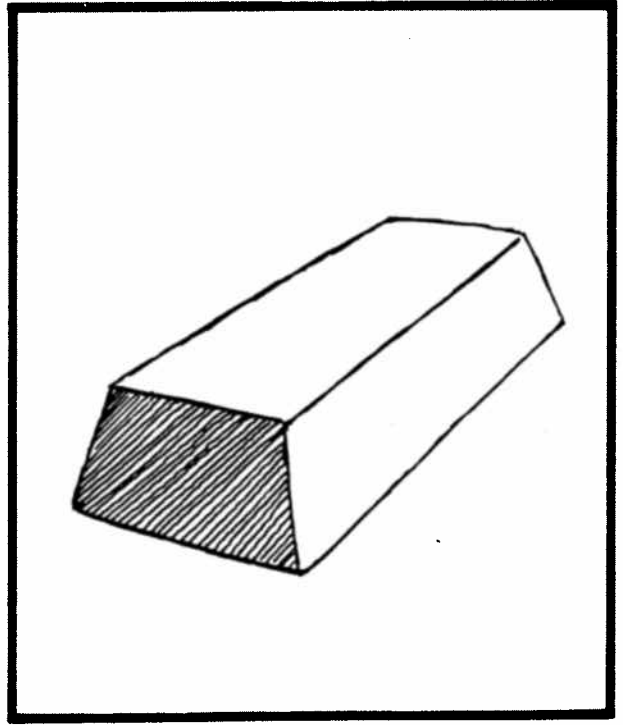

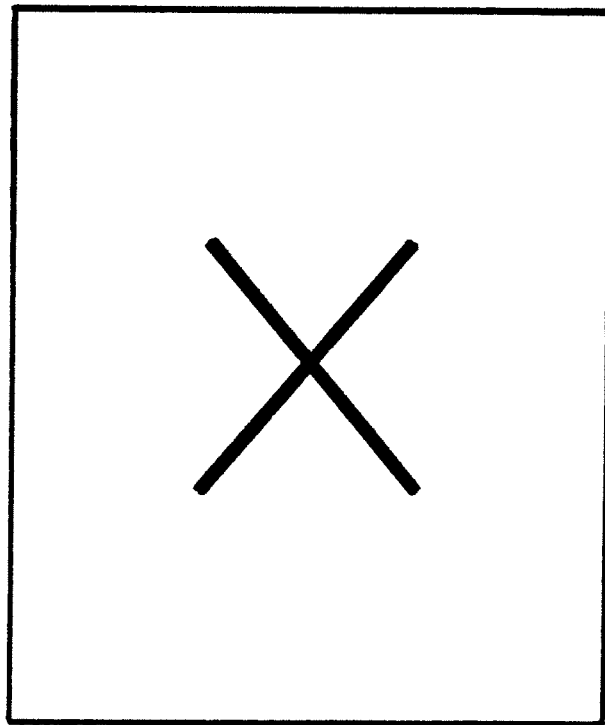

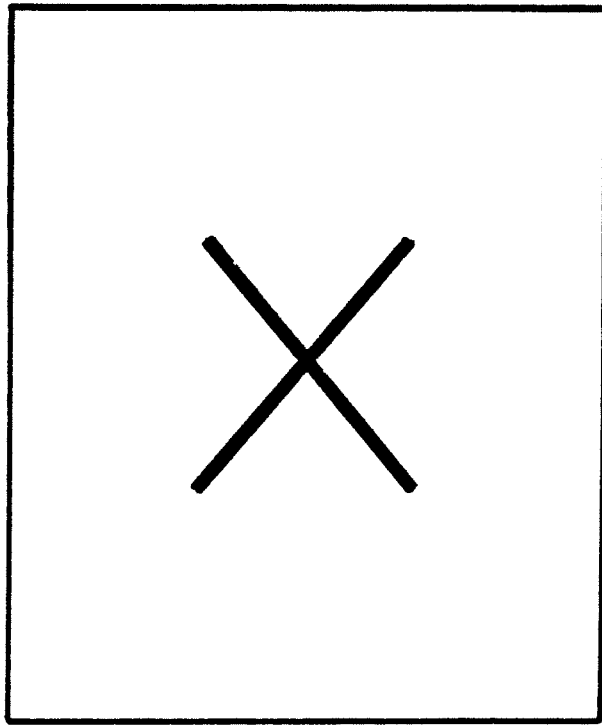

1

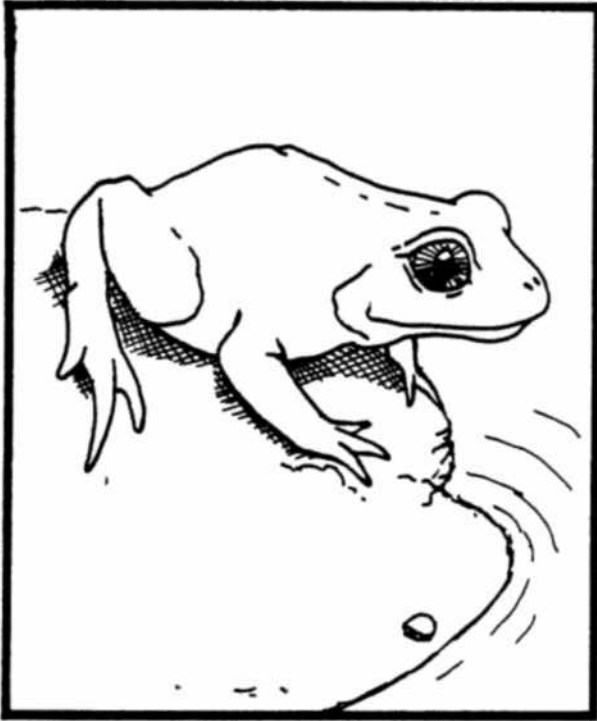

2

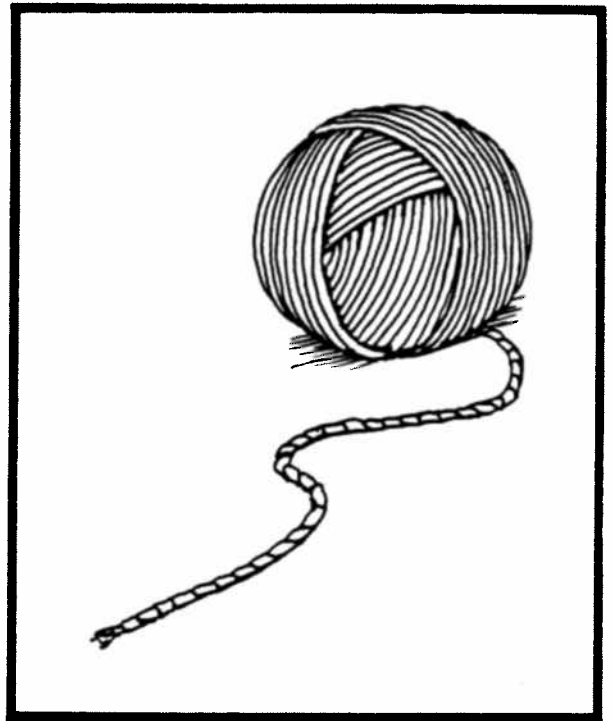

3

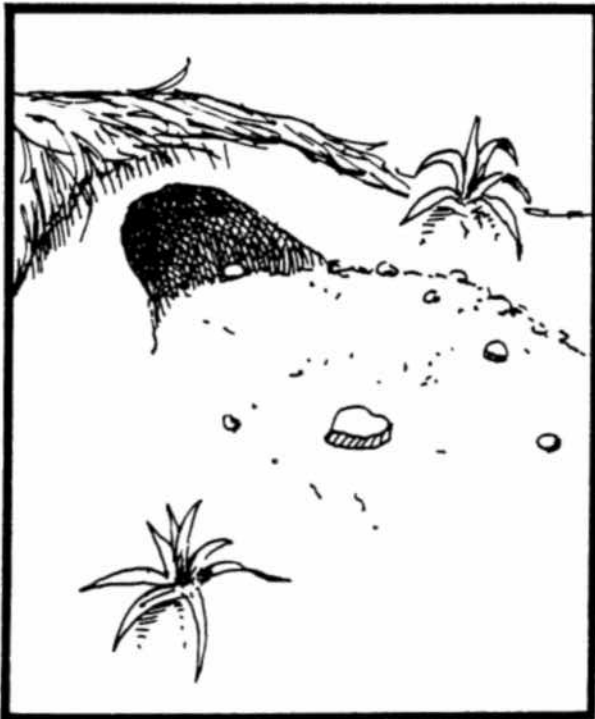

4



1

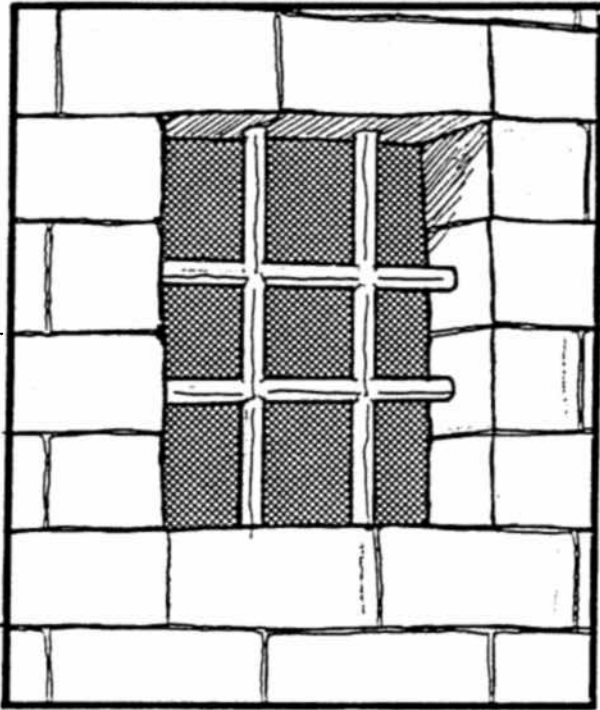

2

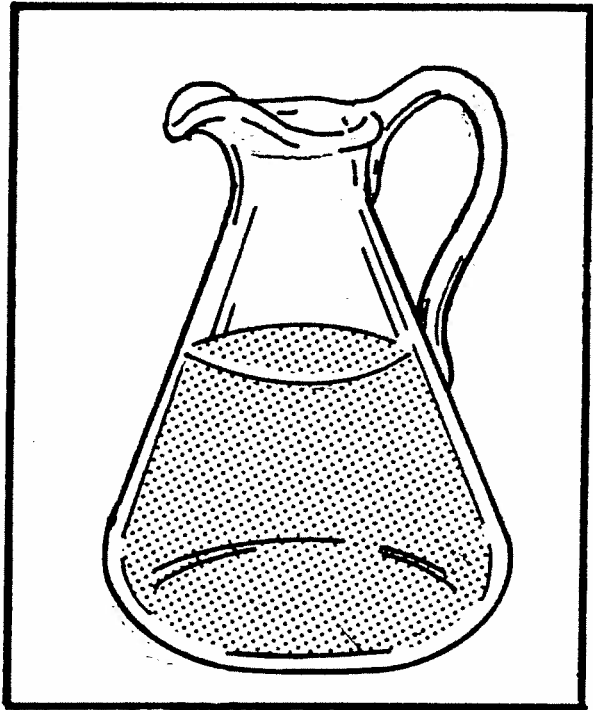

3

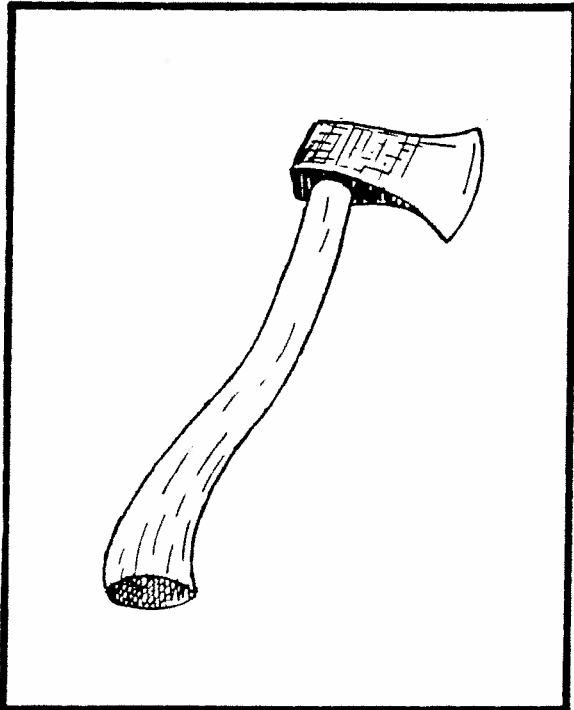

4

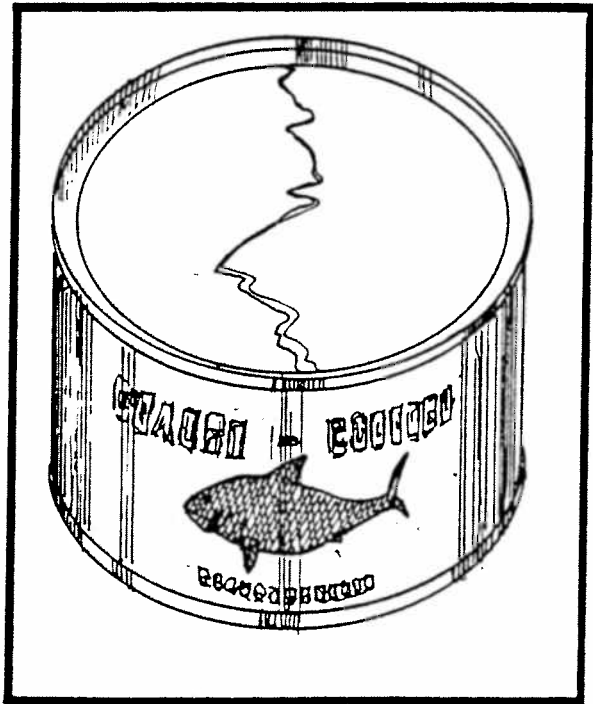

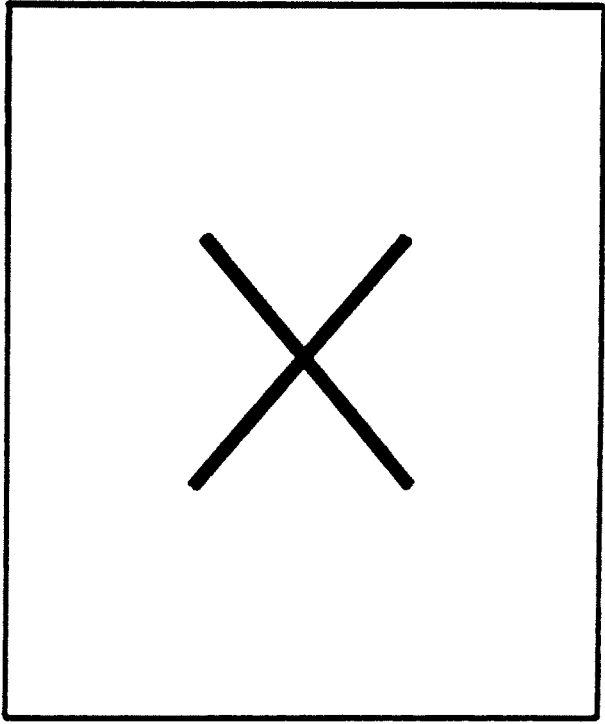

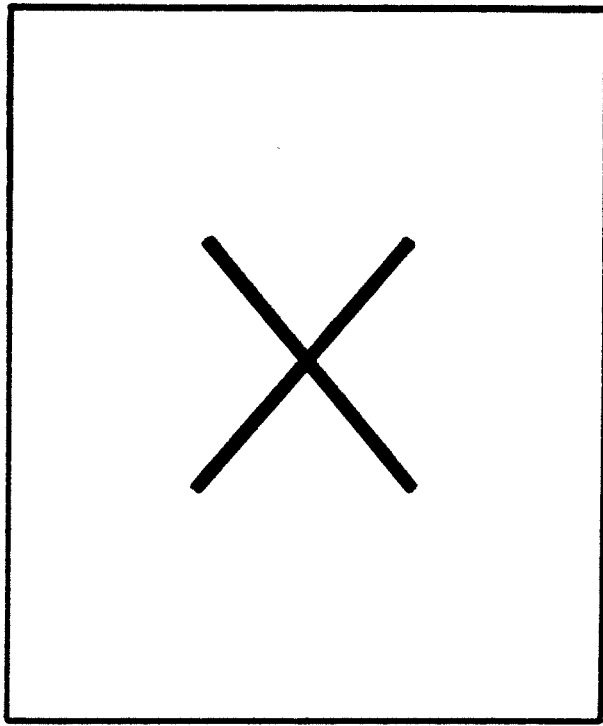

1



2



3

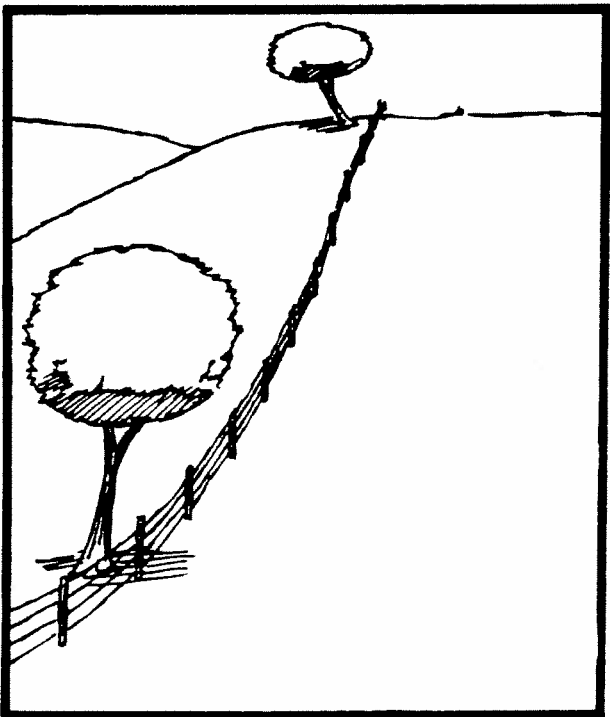

4



1



2



3

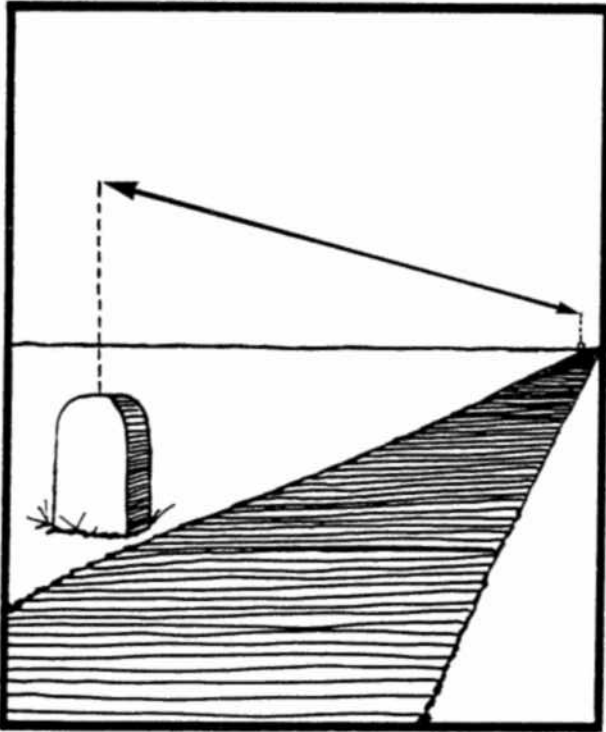

4

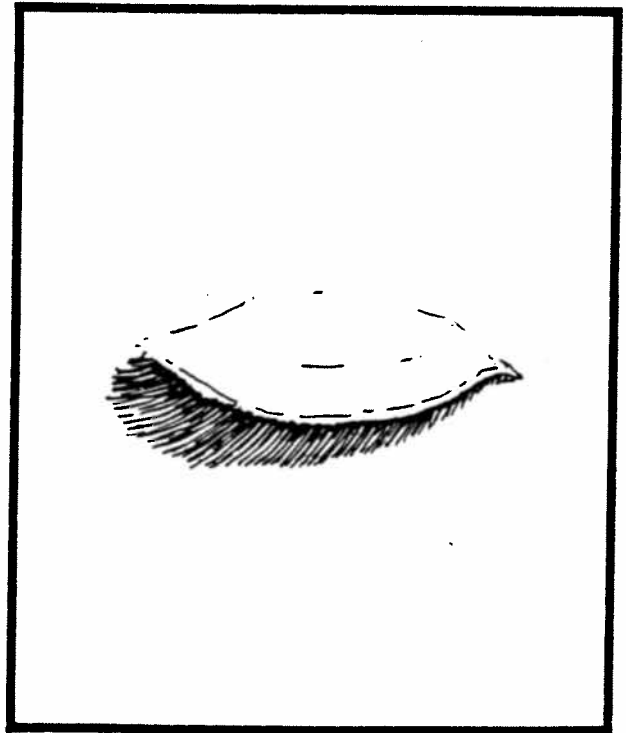

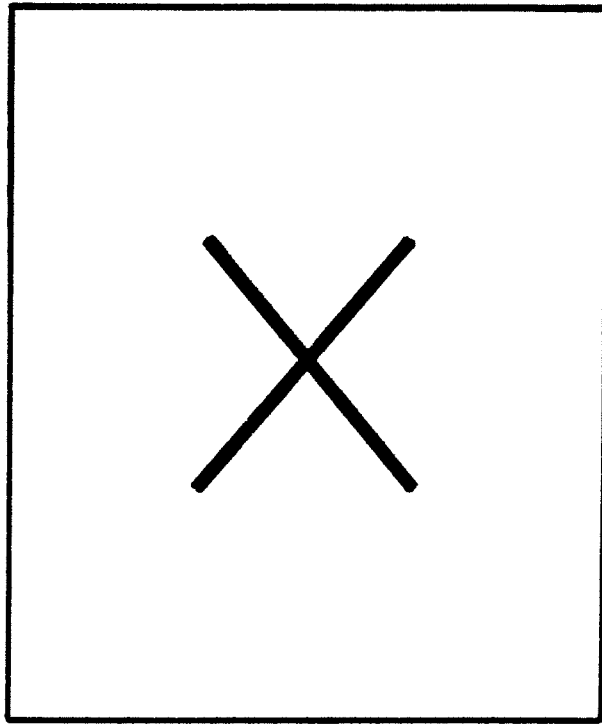

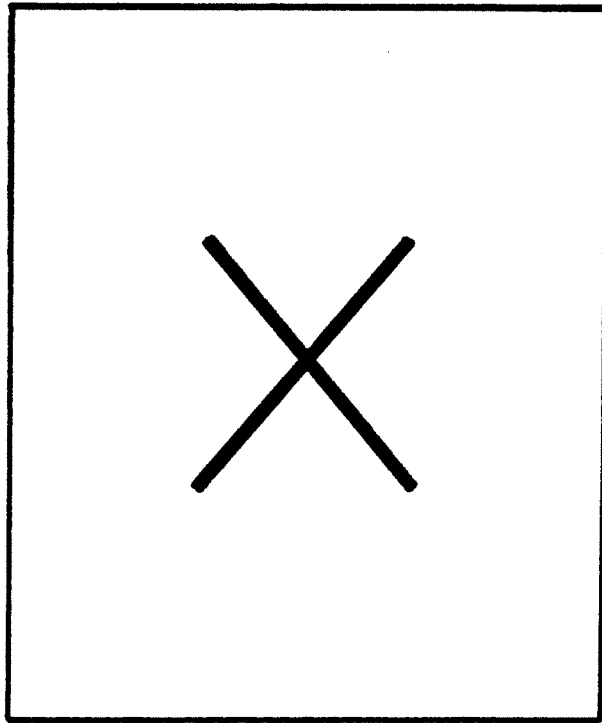

1



2

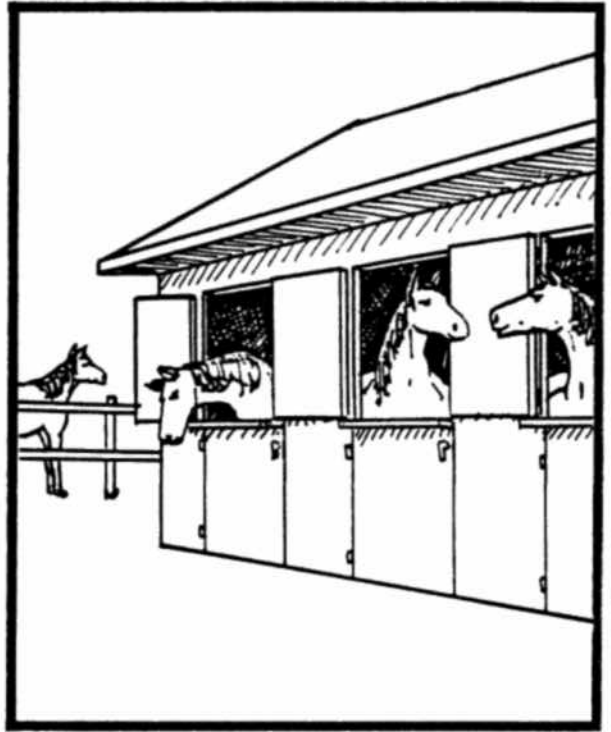

3

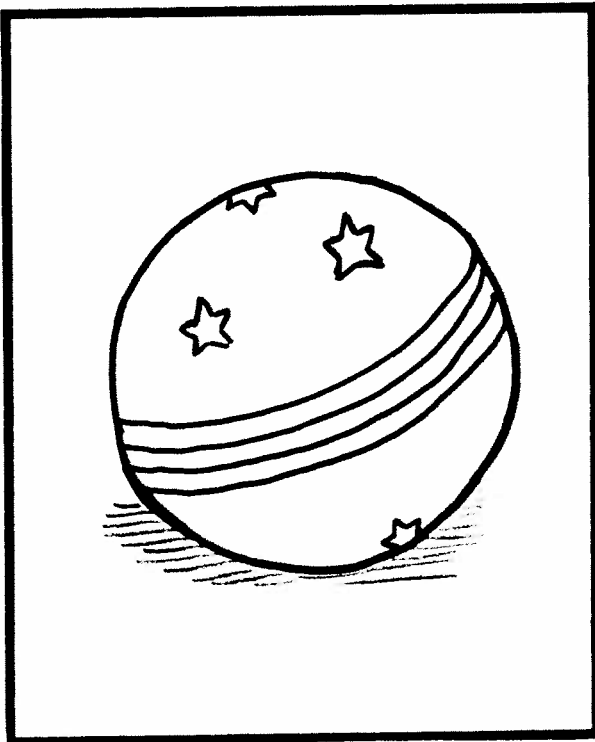

4

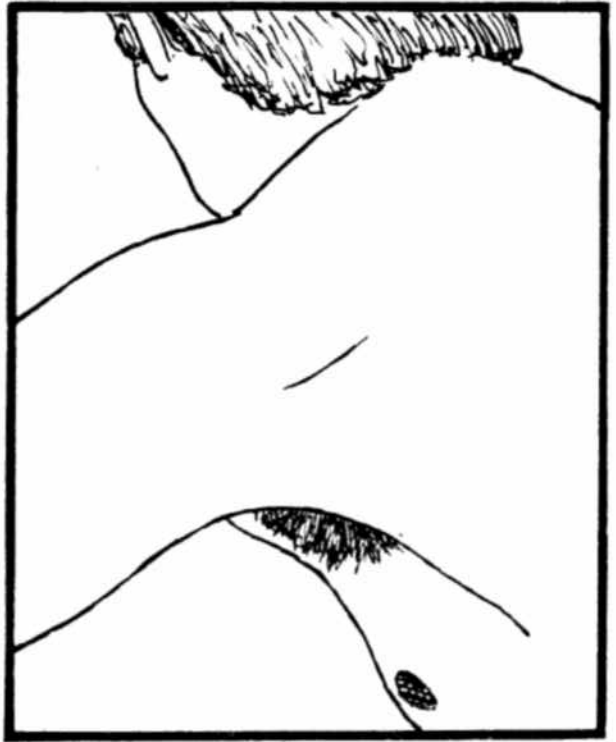

1

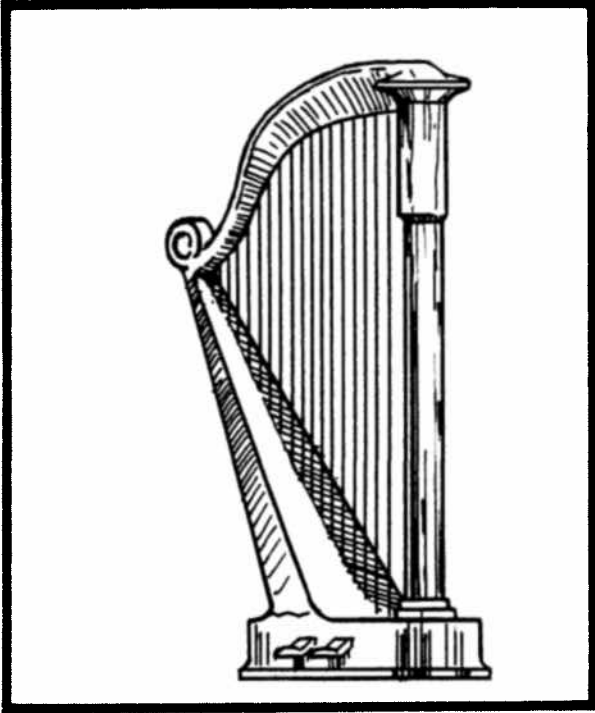

2

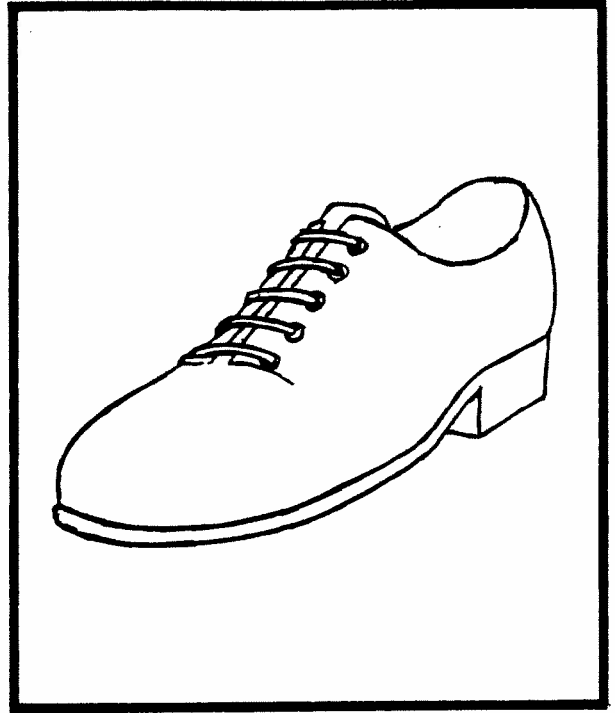

3

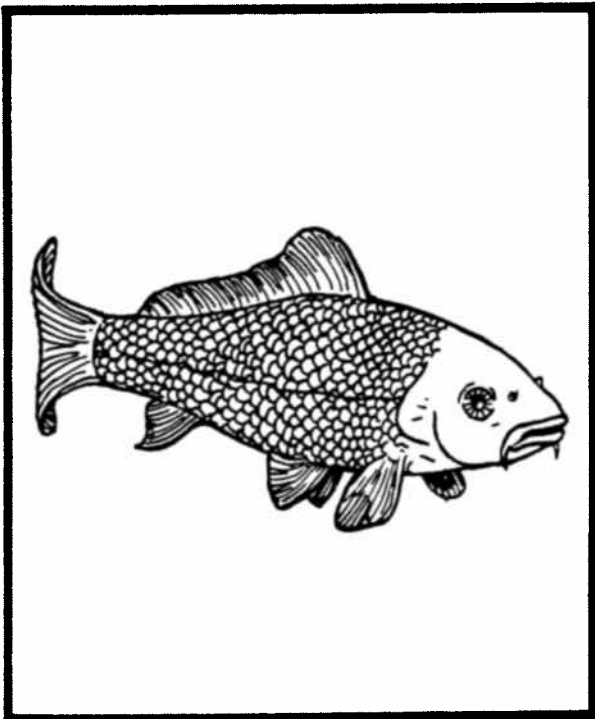

4

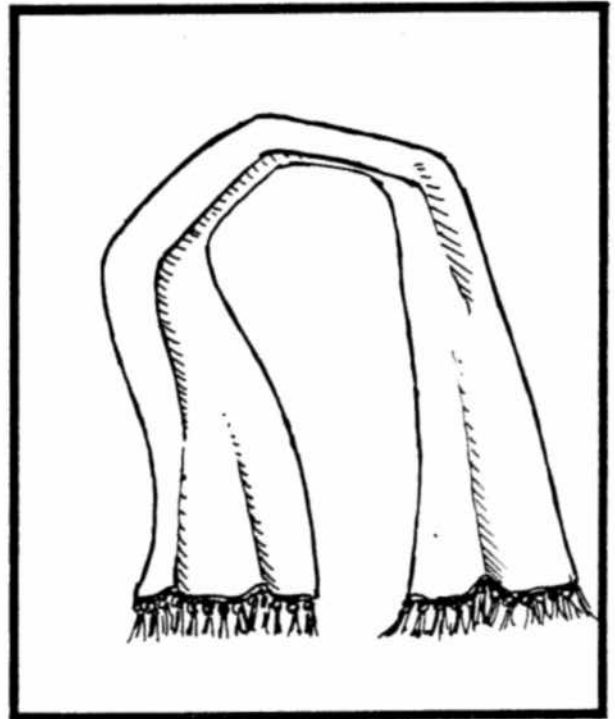

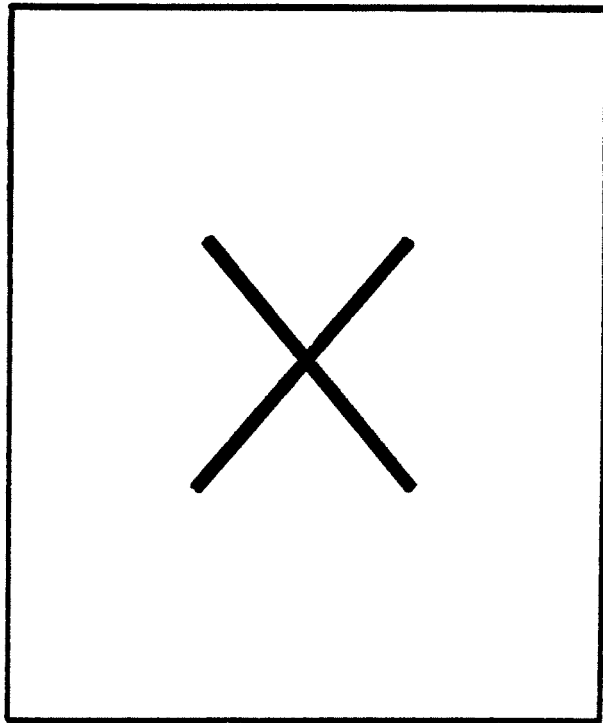

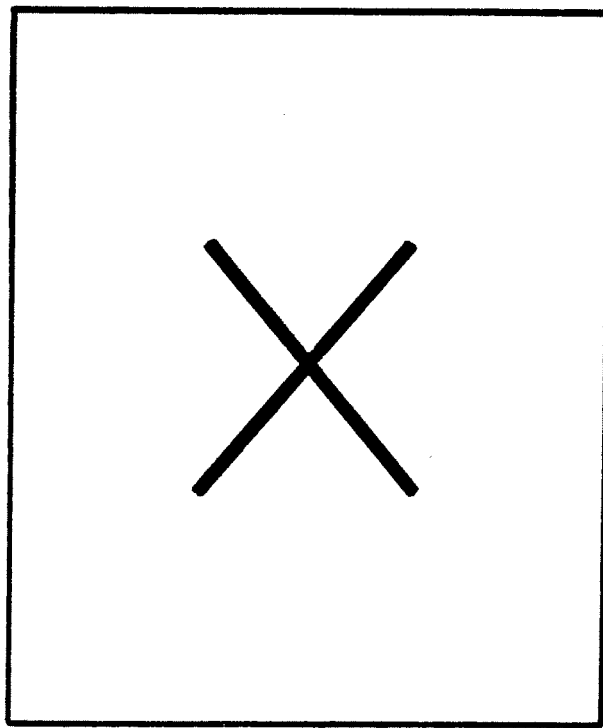

1

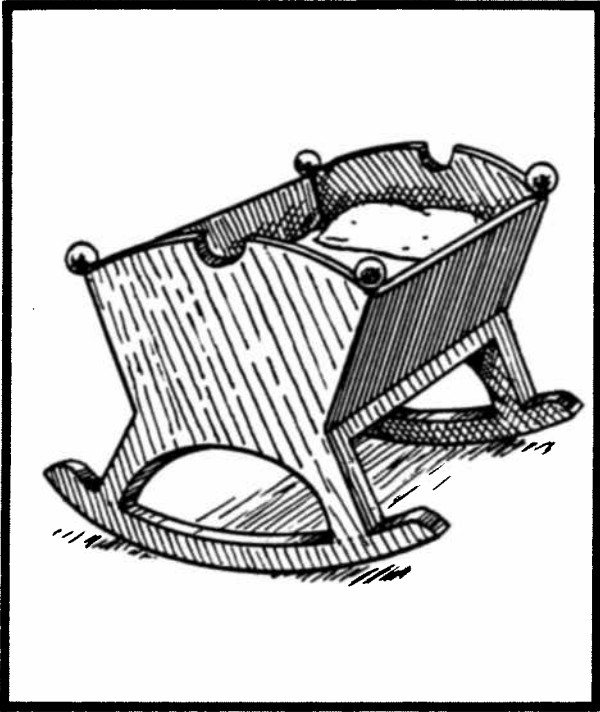

2

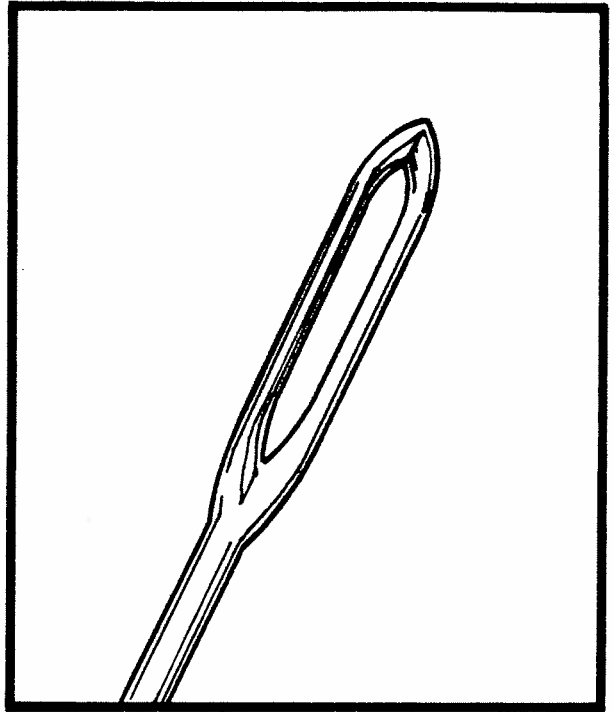

3

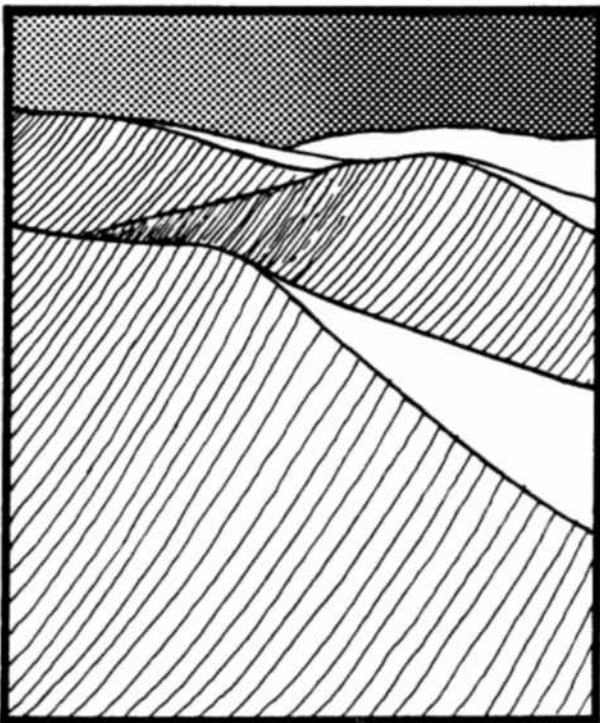

4

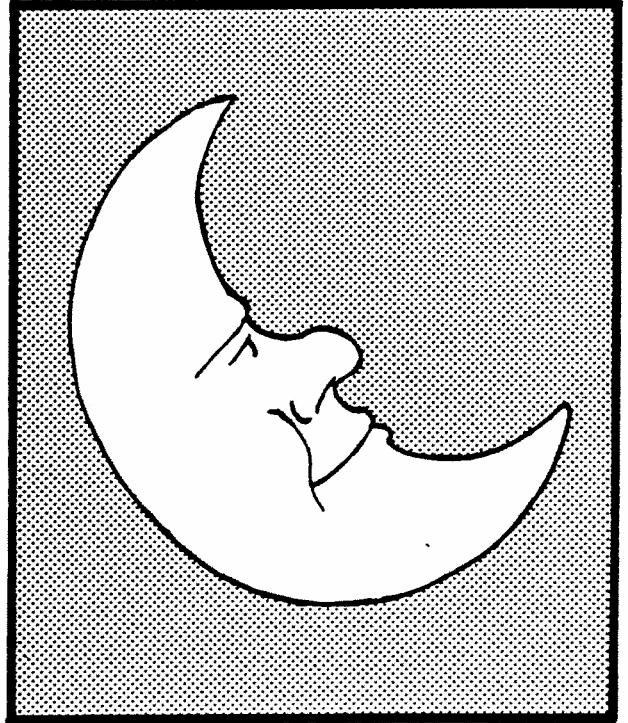

1

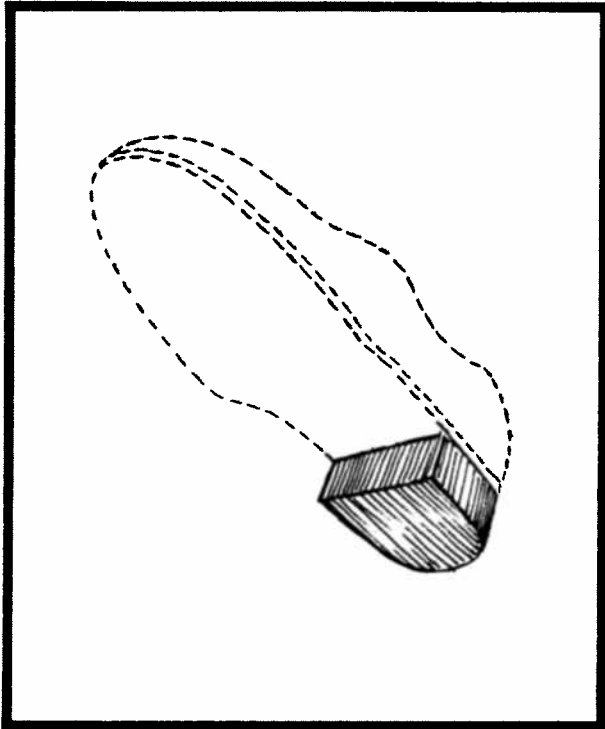

2

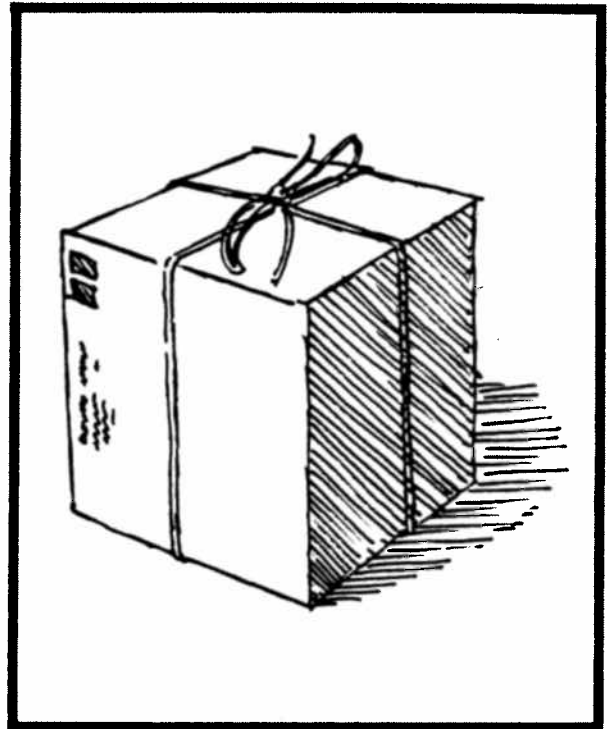

3



4

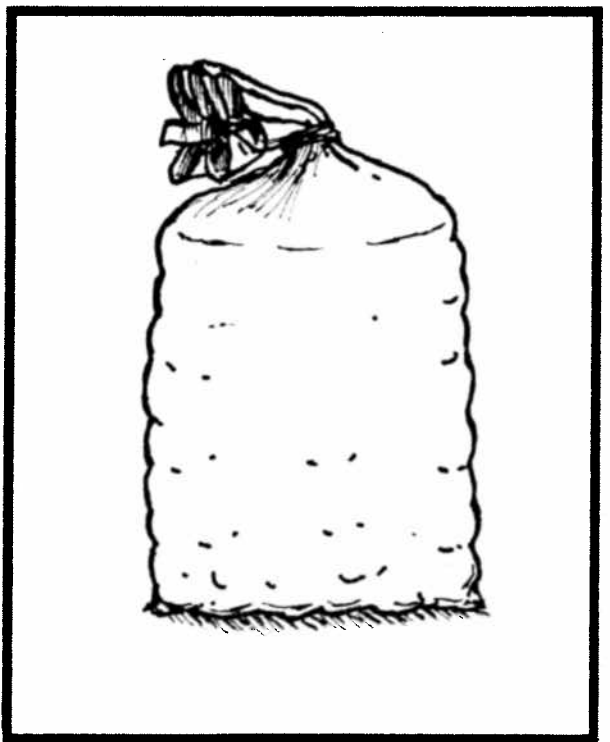

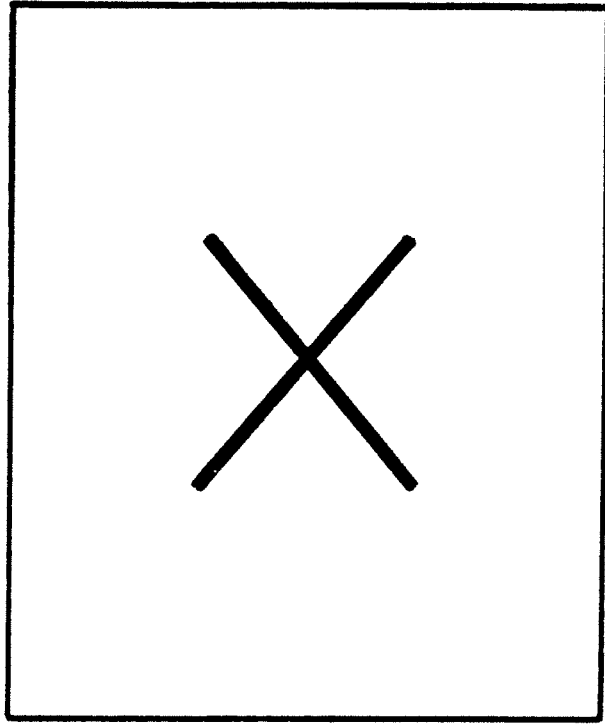

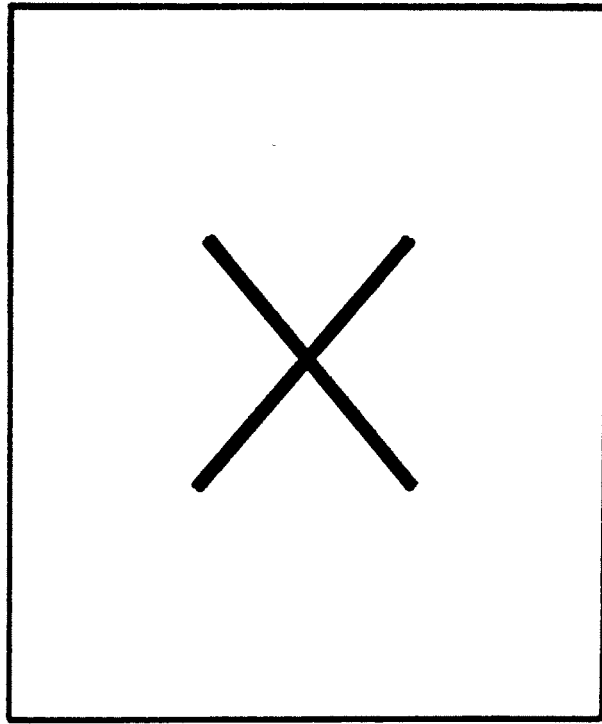

1

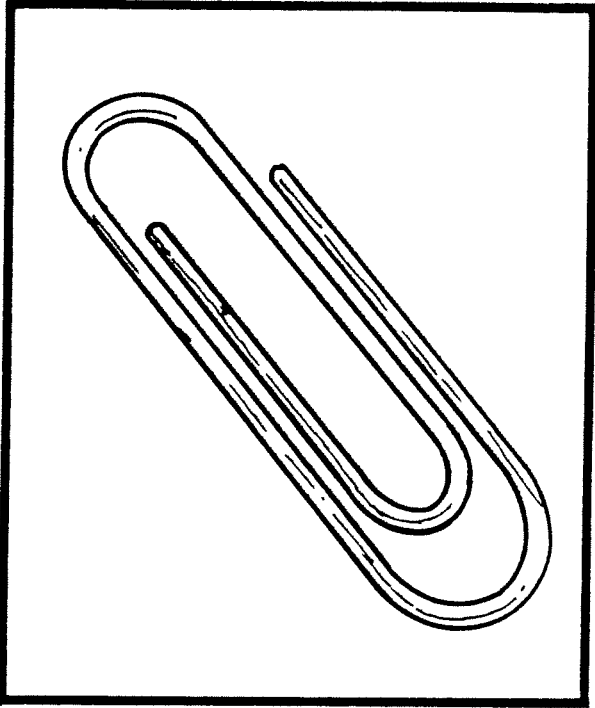

2

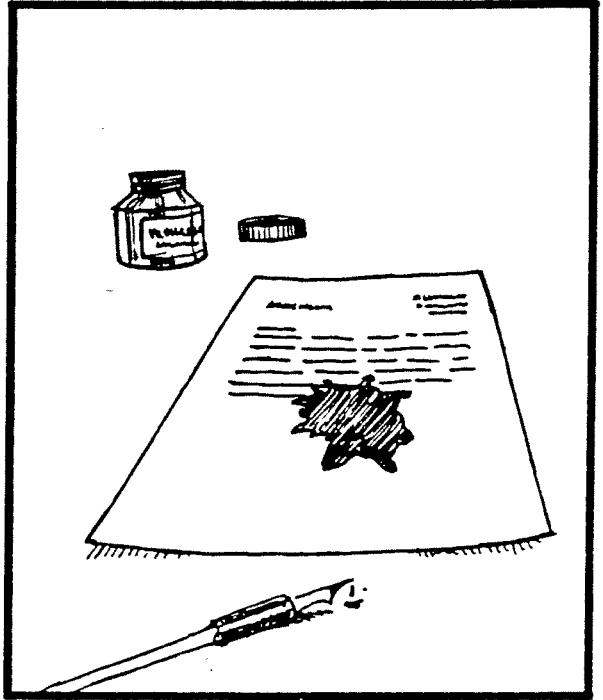

3

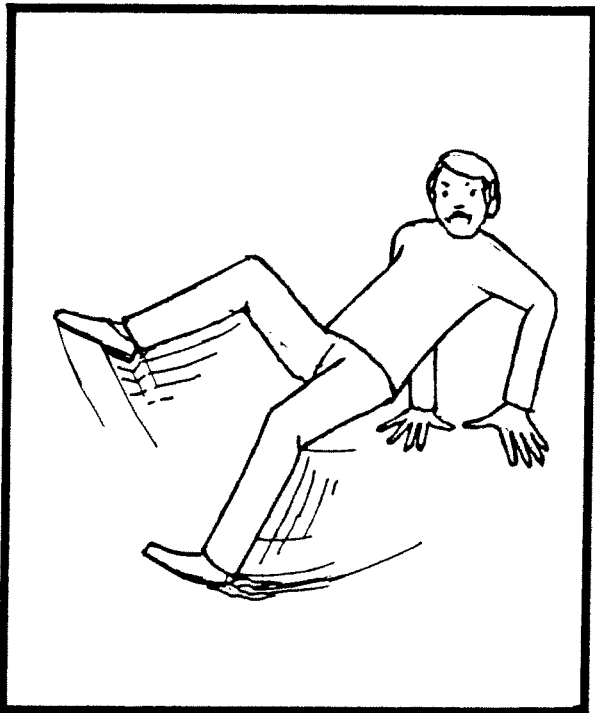

4

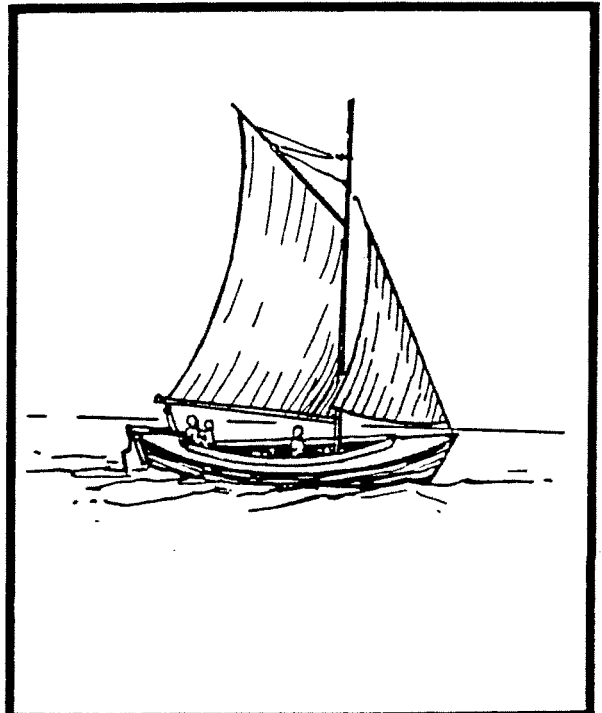

1

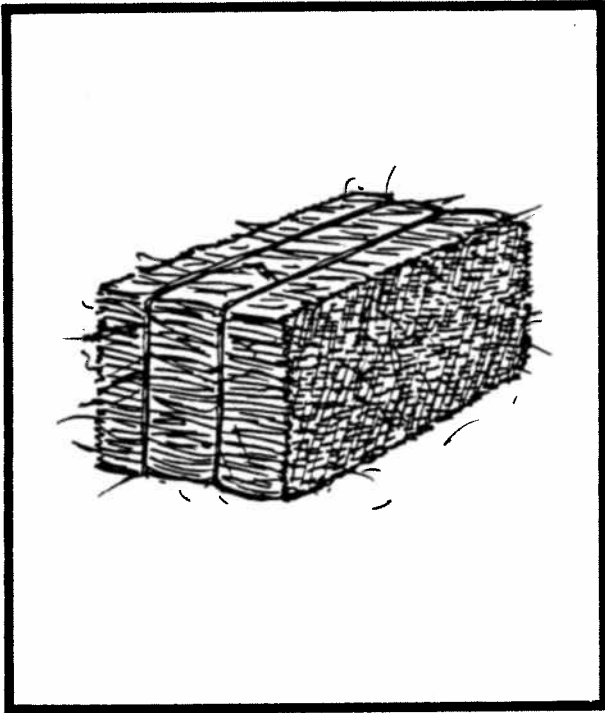

2

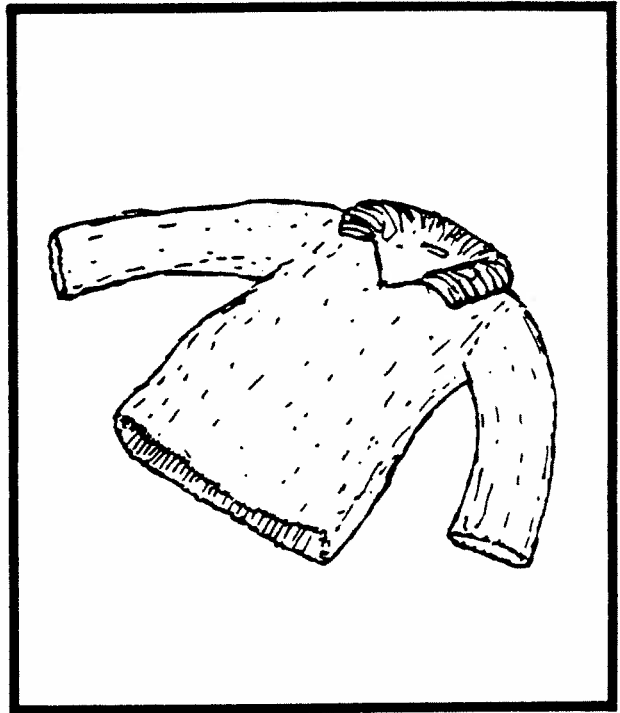

3

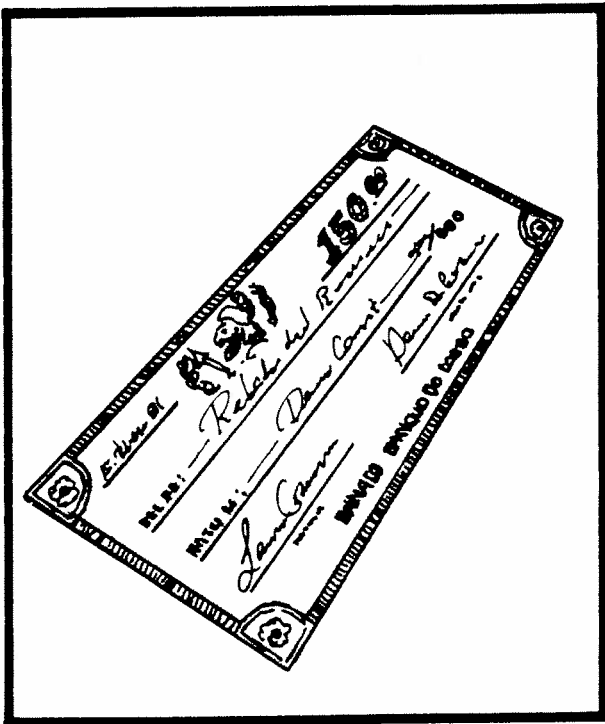

4

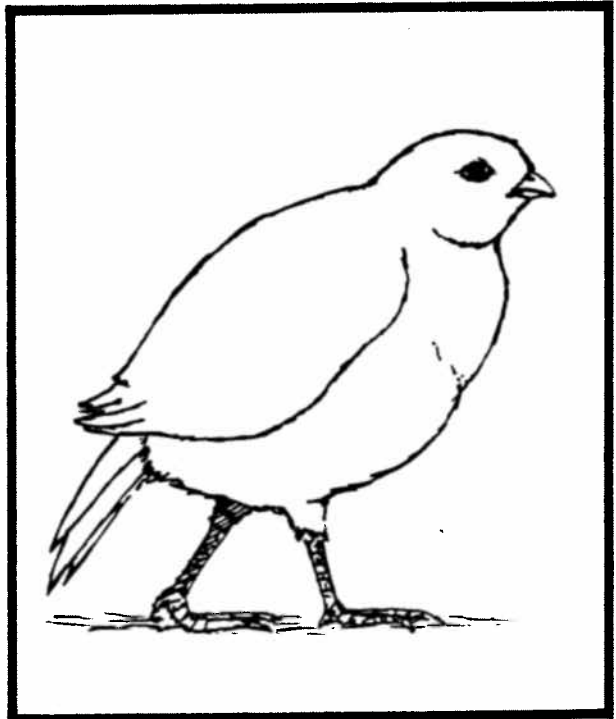

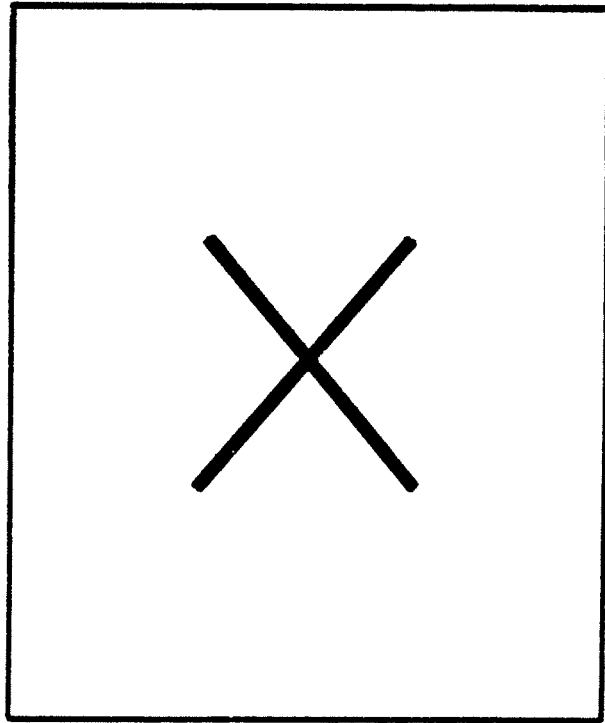

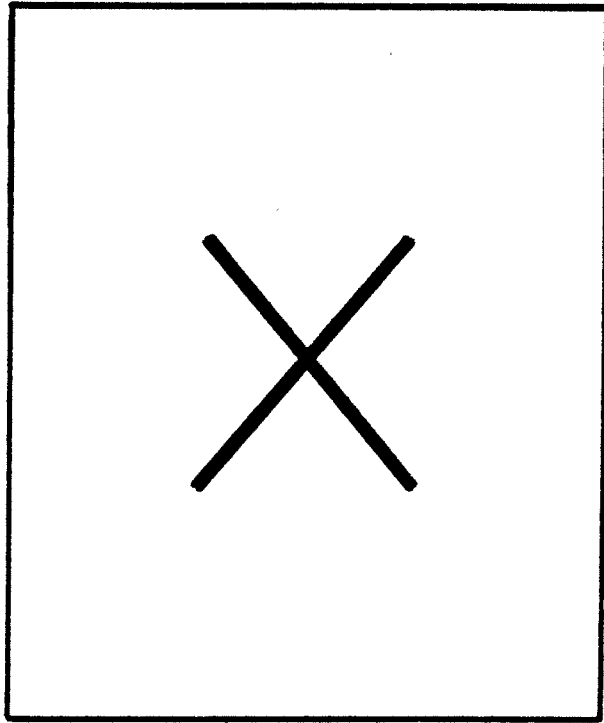

1

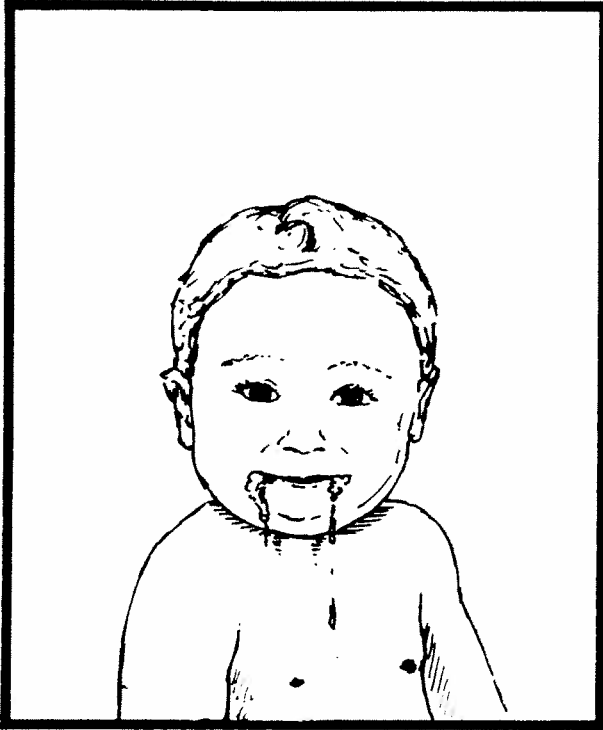

2

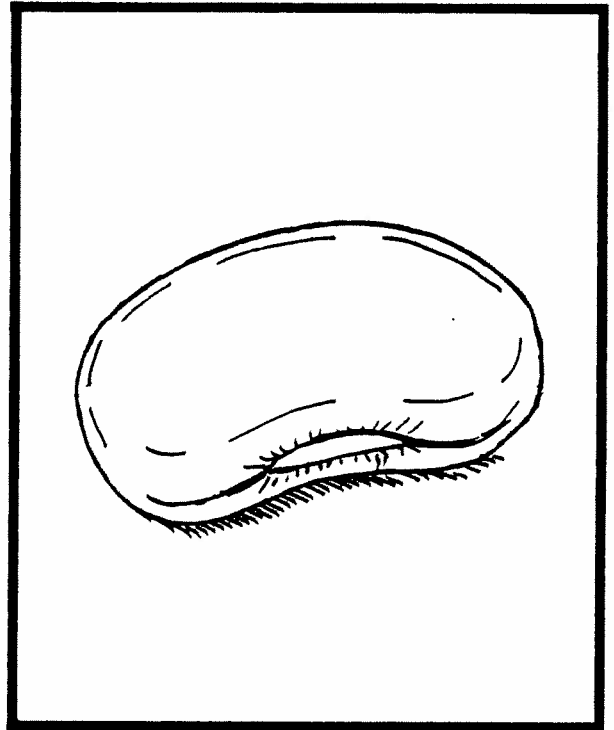

3



4



1



2

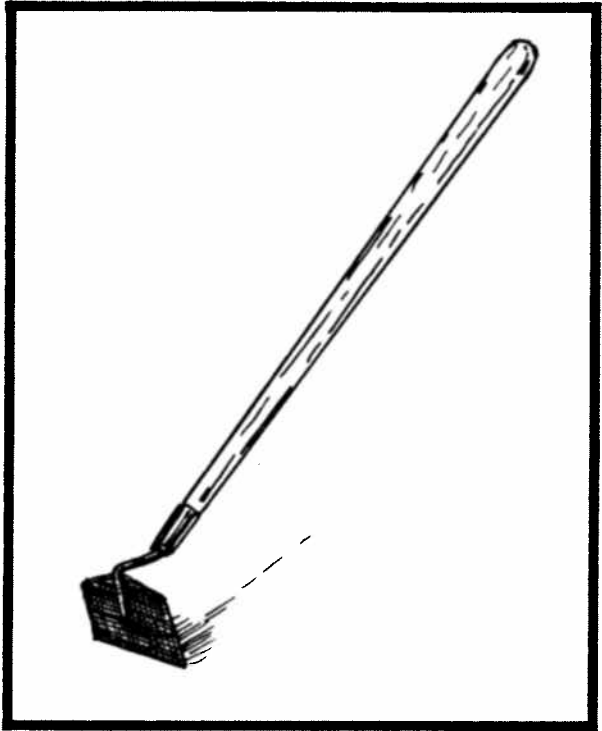

3

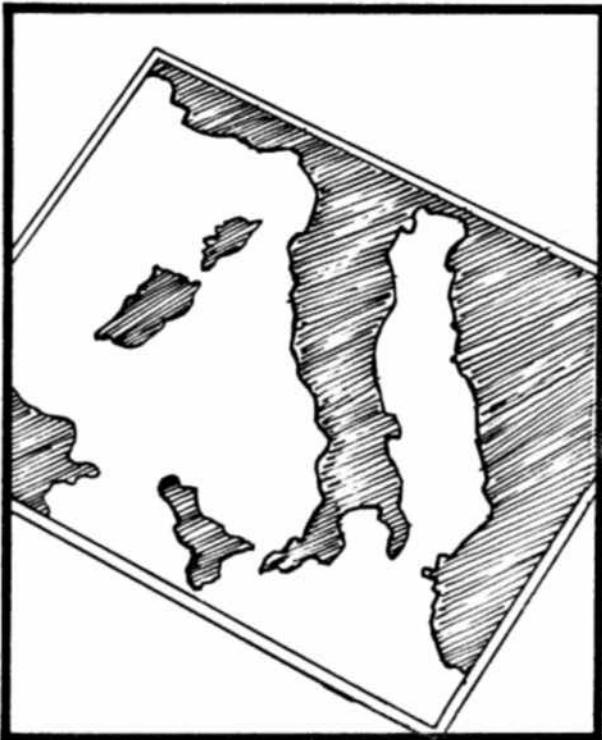

4

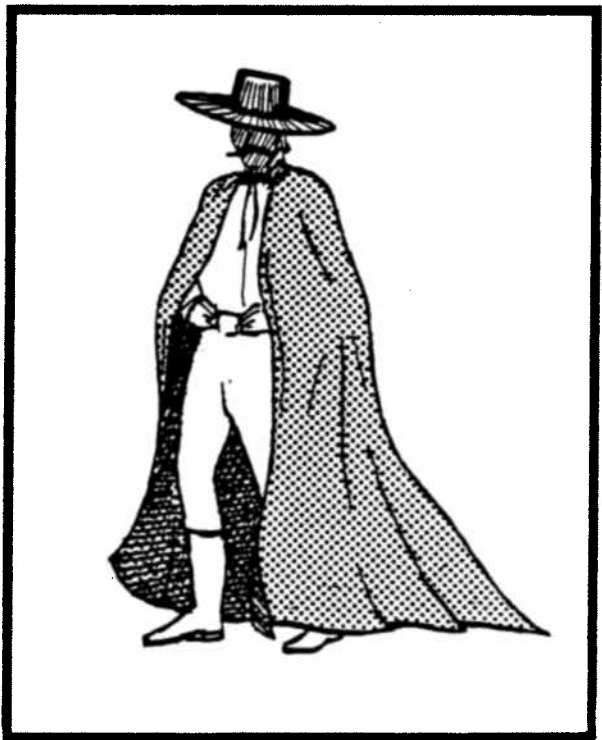

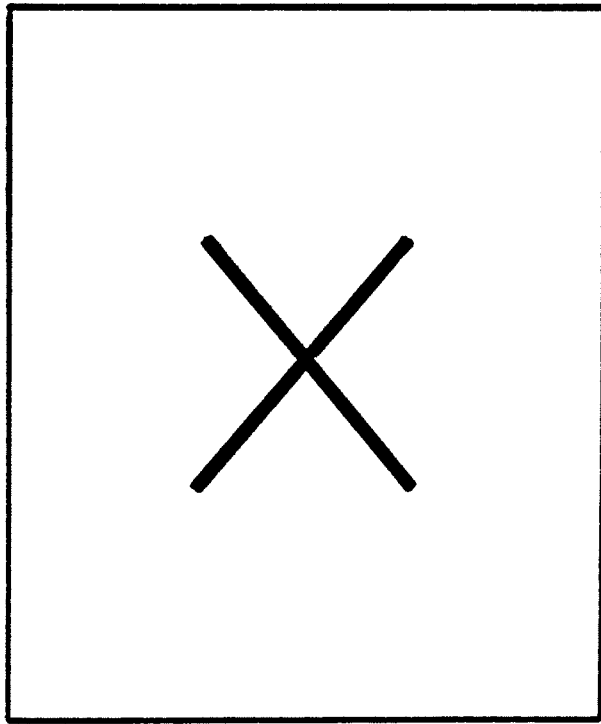

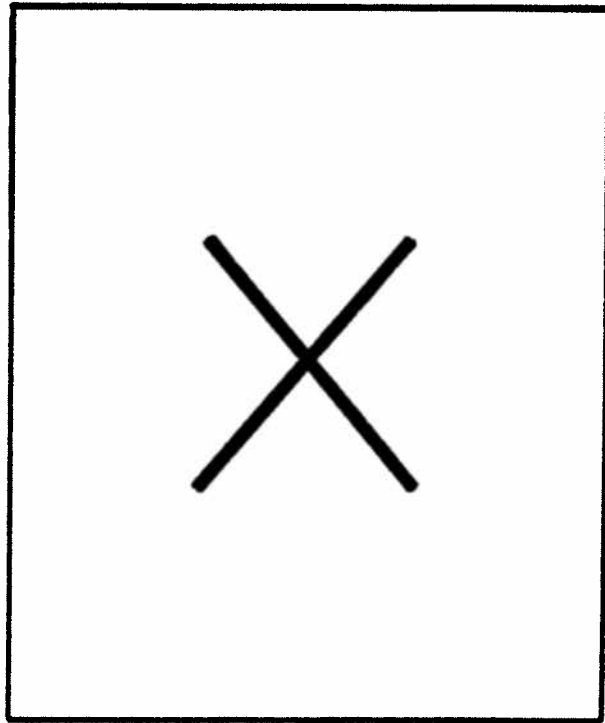

1

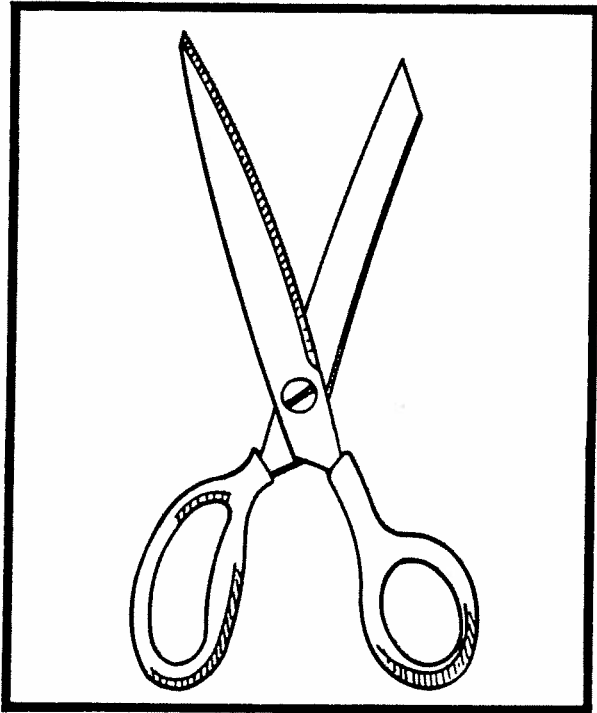

2

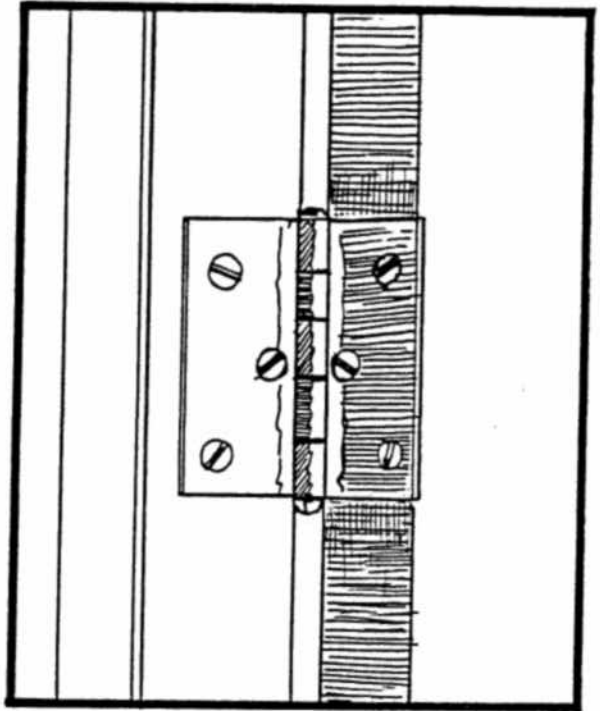

3

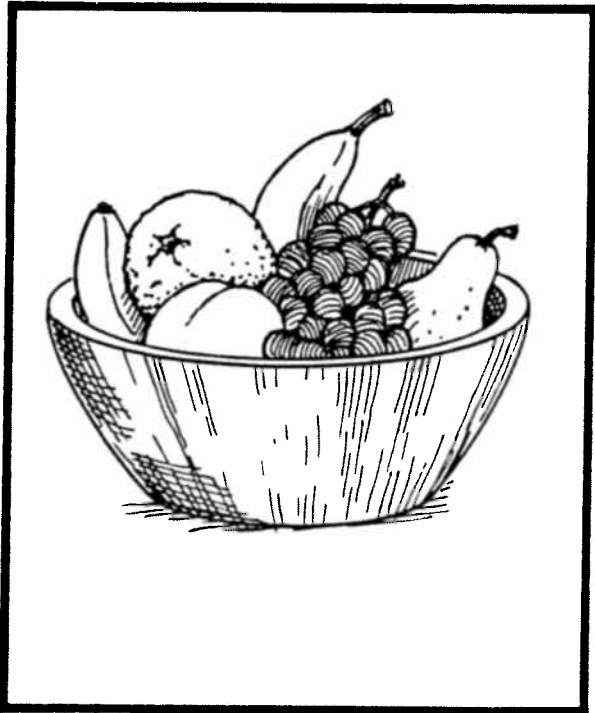

4

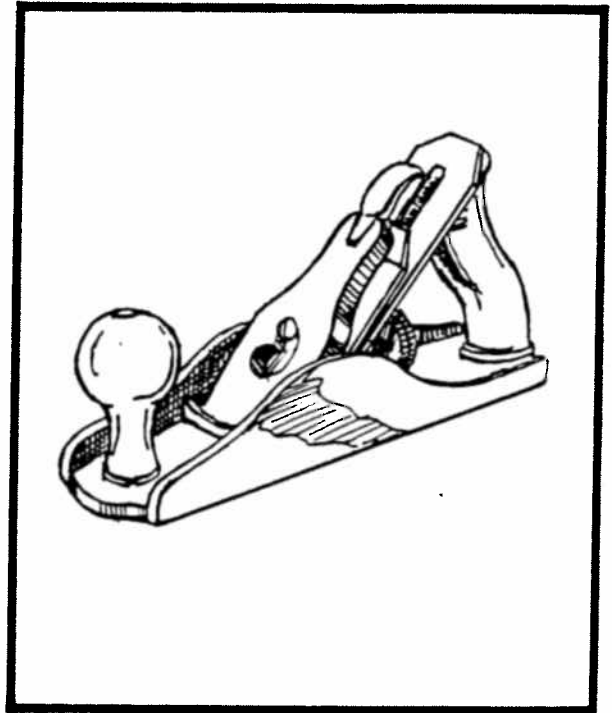

1

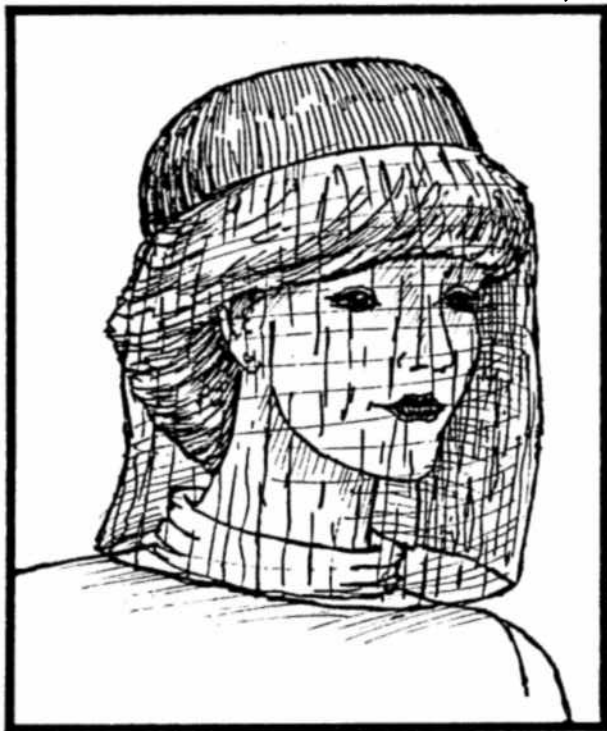

2

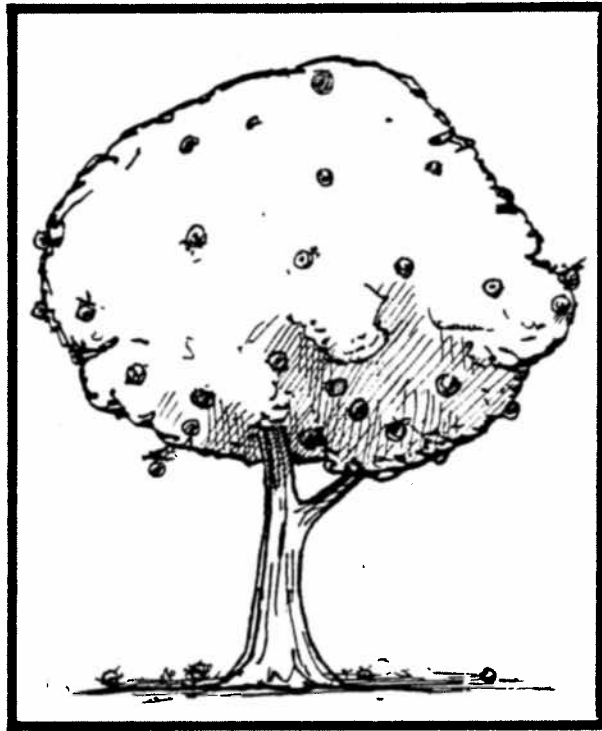

3

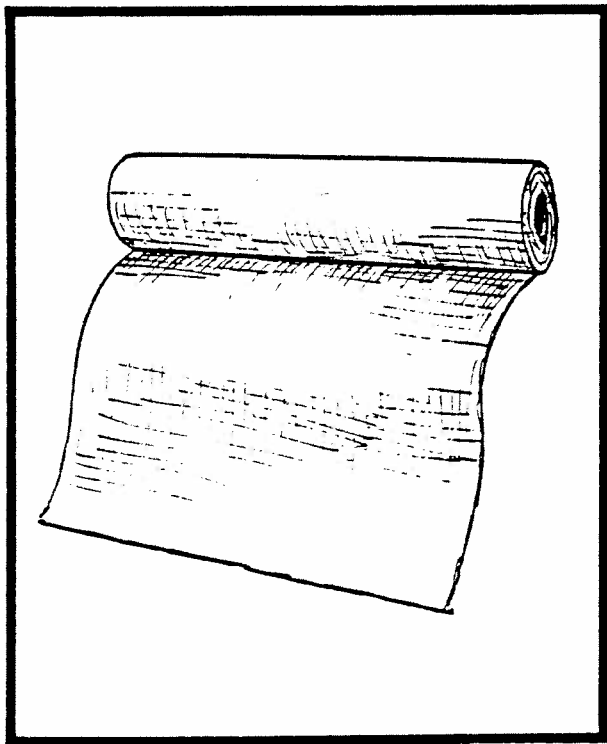

4

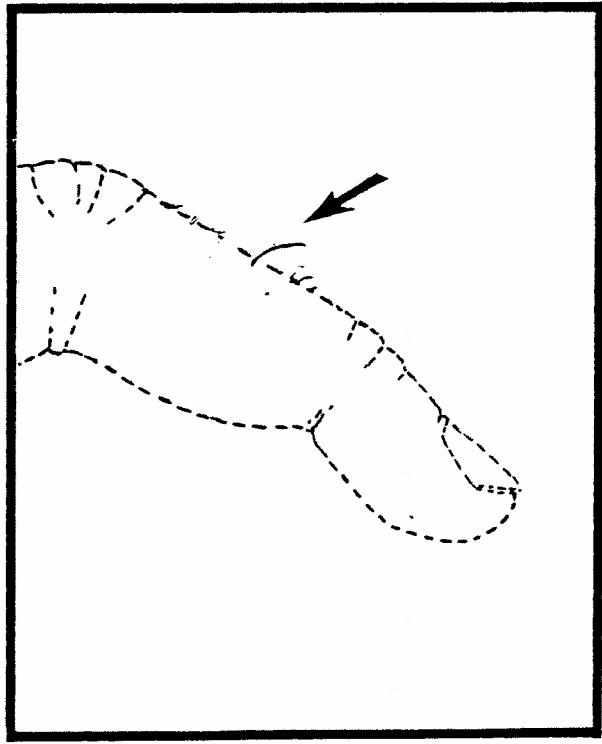

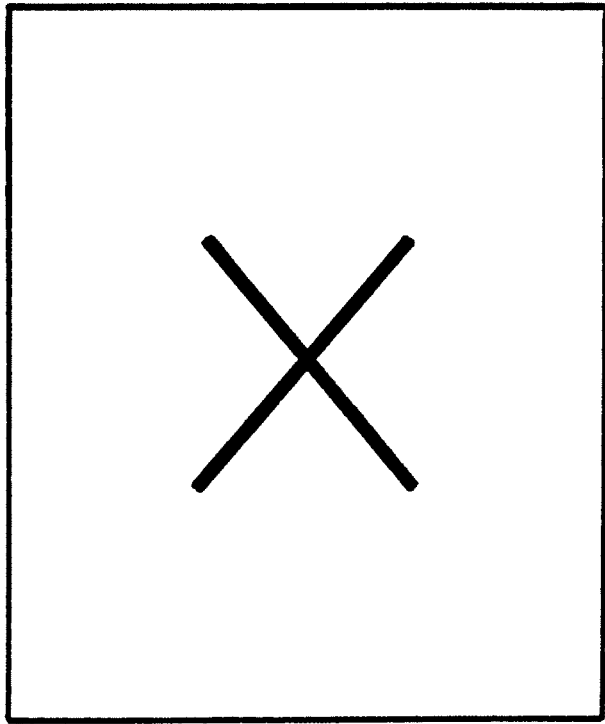

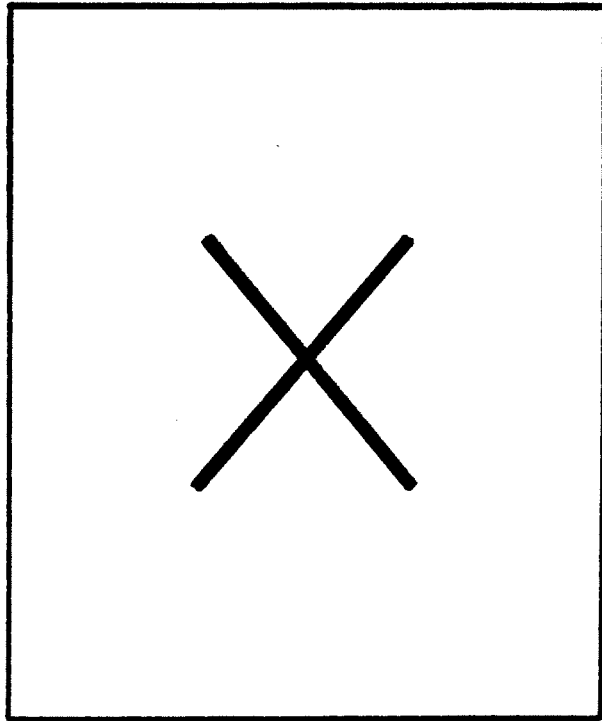

1



2

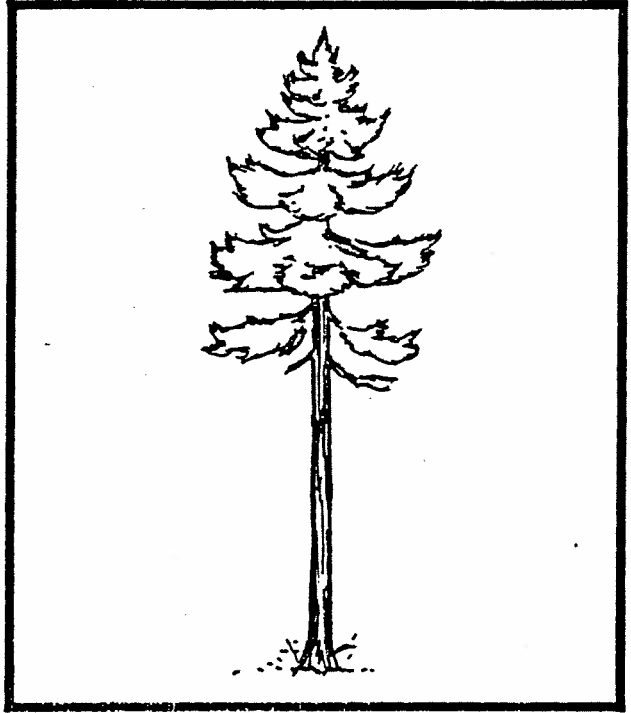

3

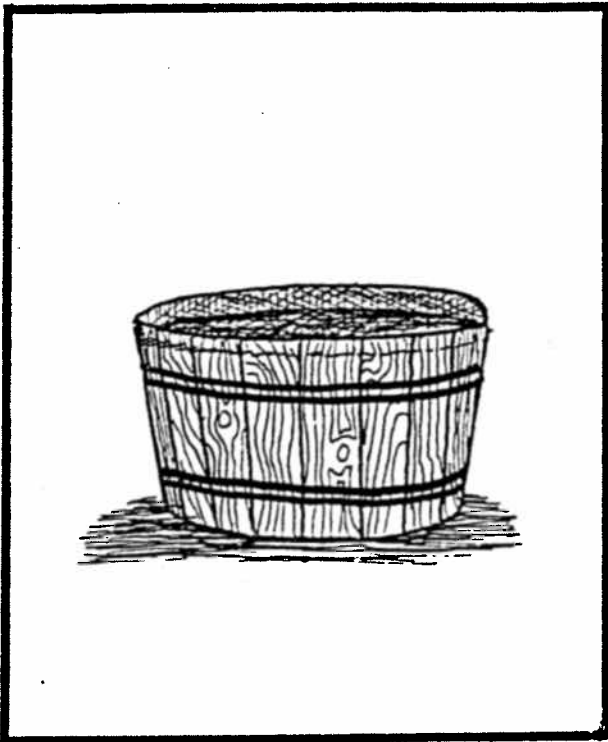

4

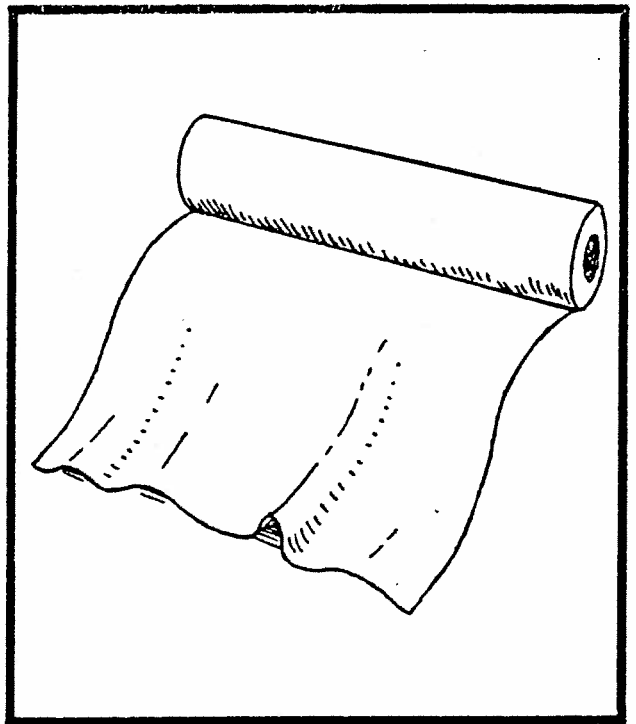

1

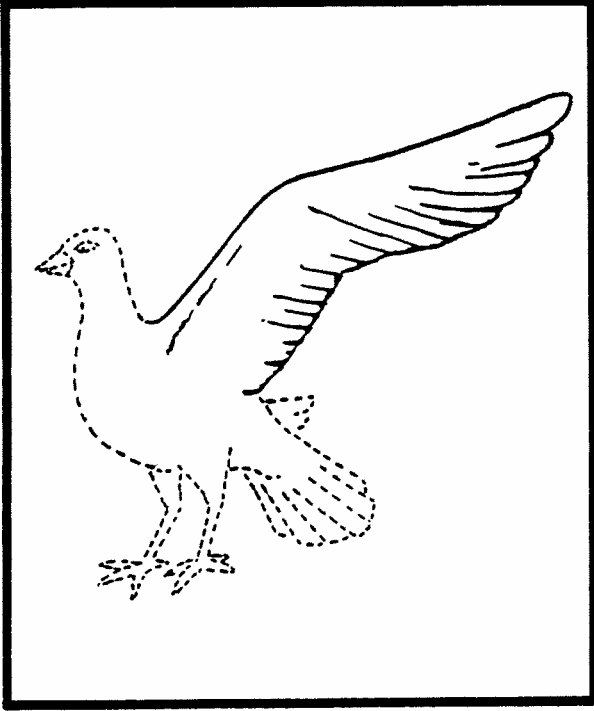

2

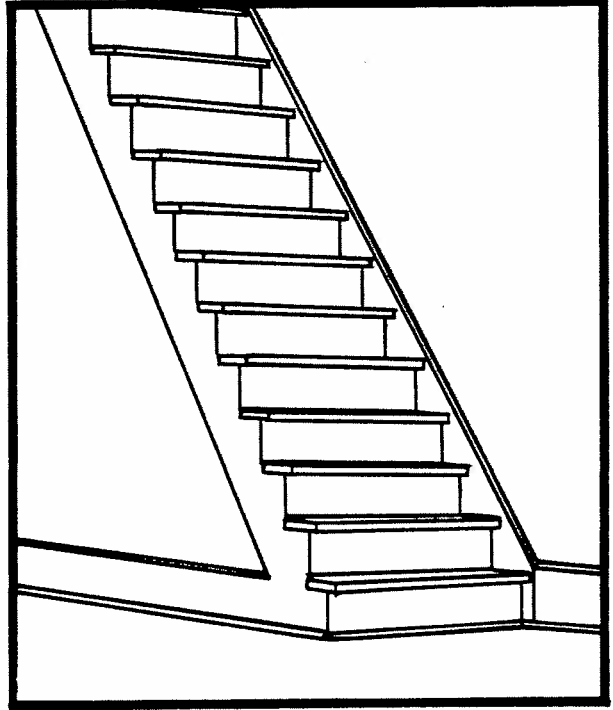

3

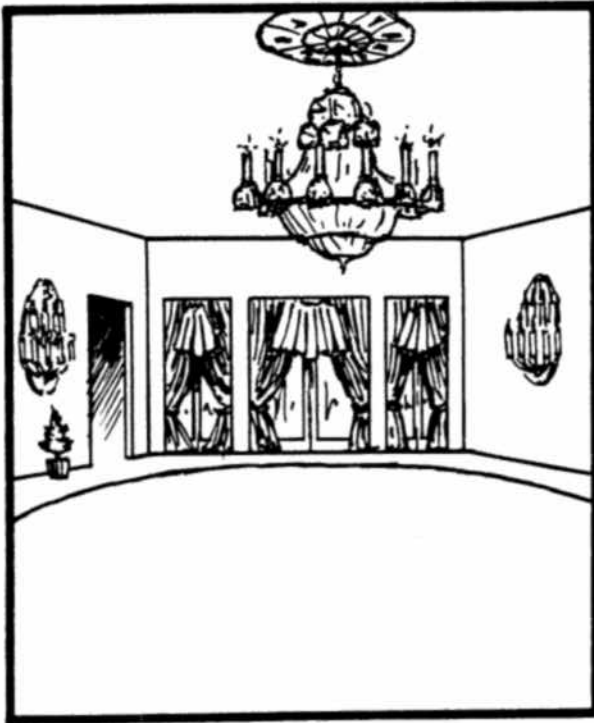

4

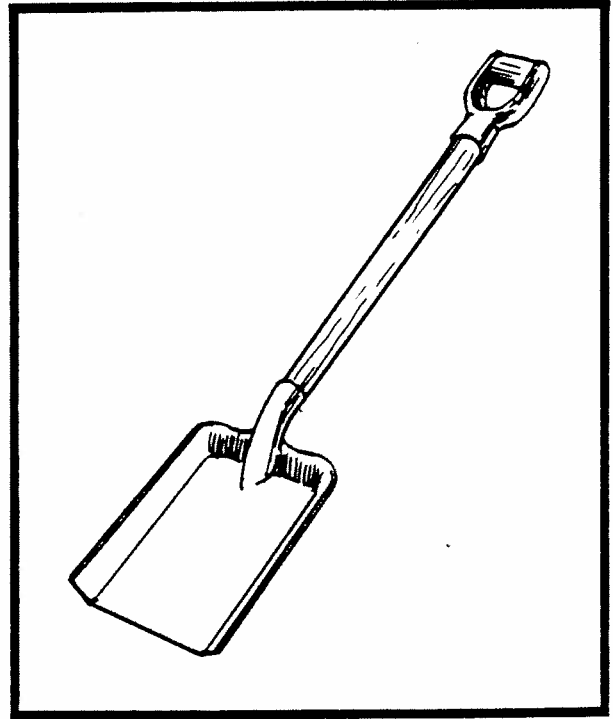

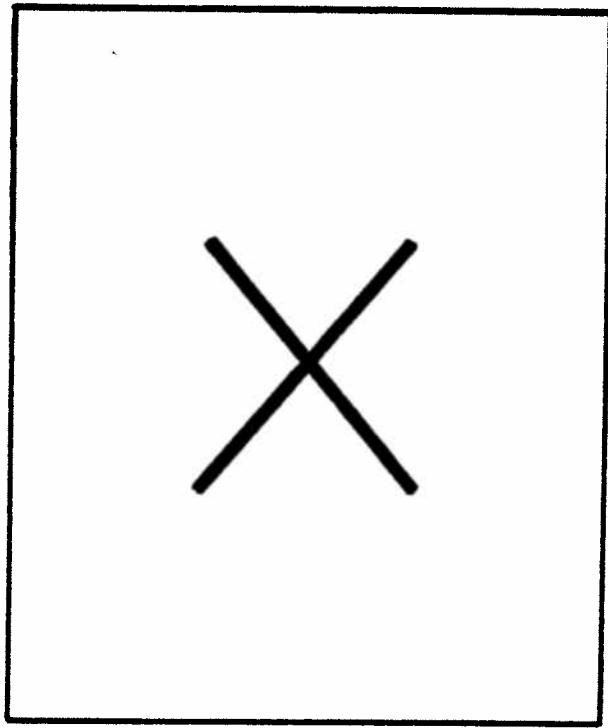

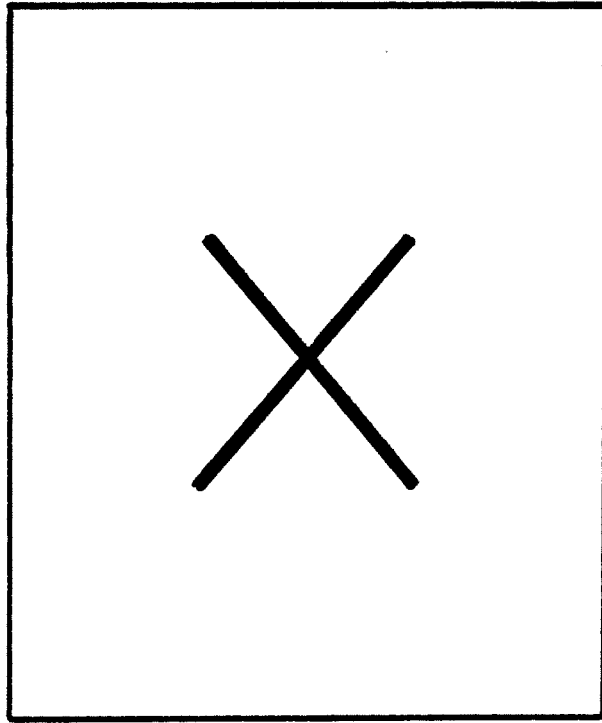

1

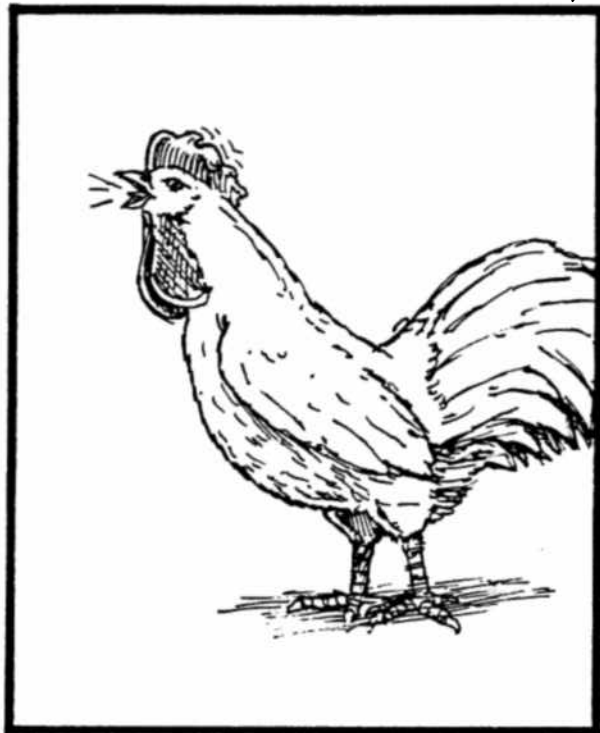

2

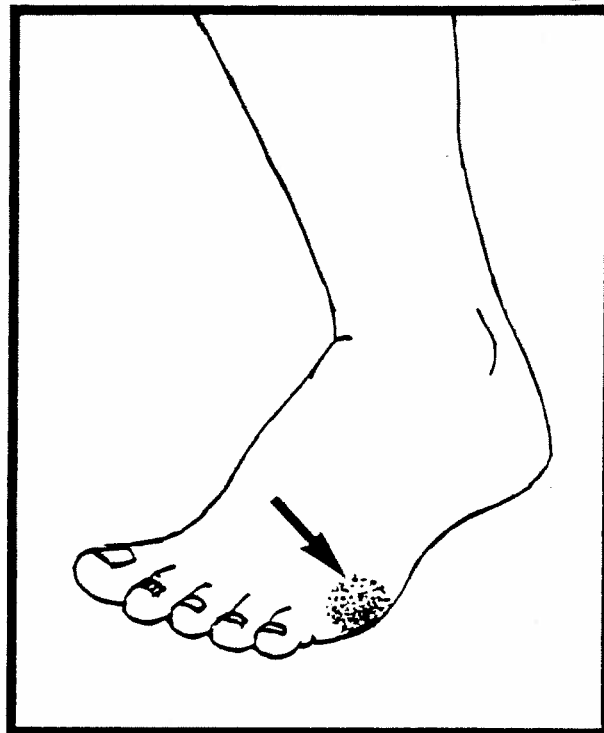

3

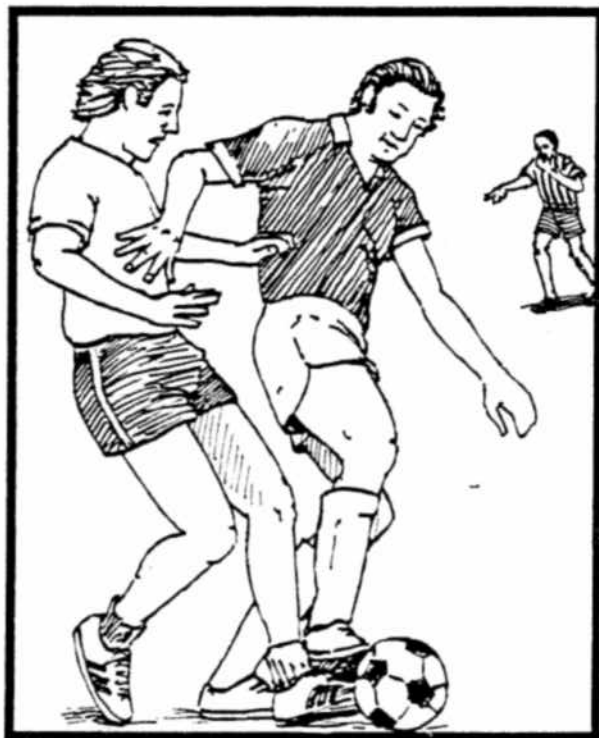

4

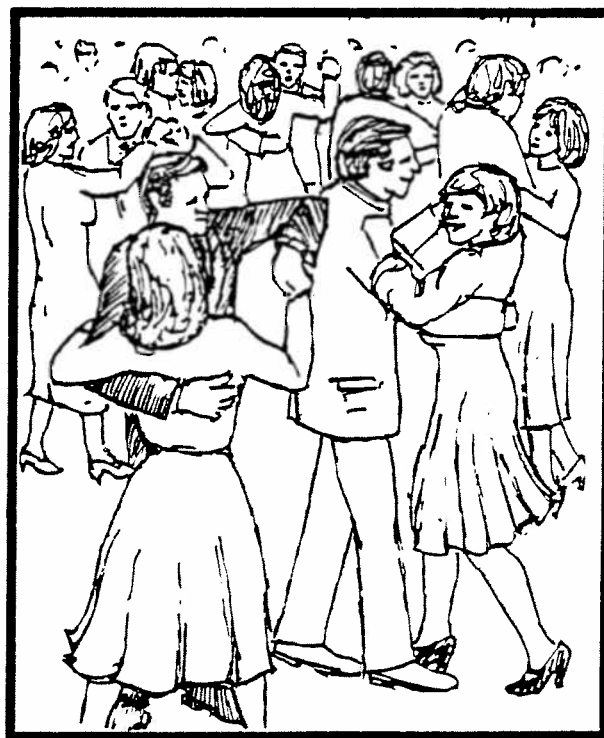

COMPRESIONE DI STRUTTURE SINTATTICHE

1

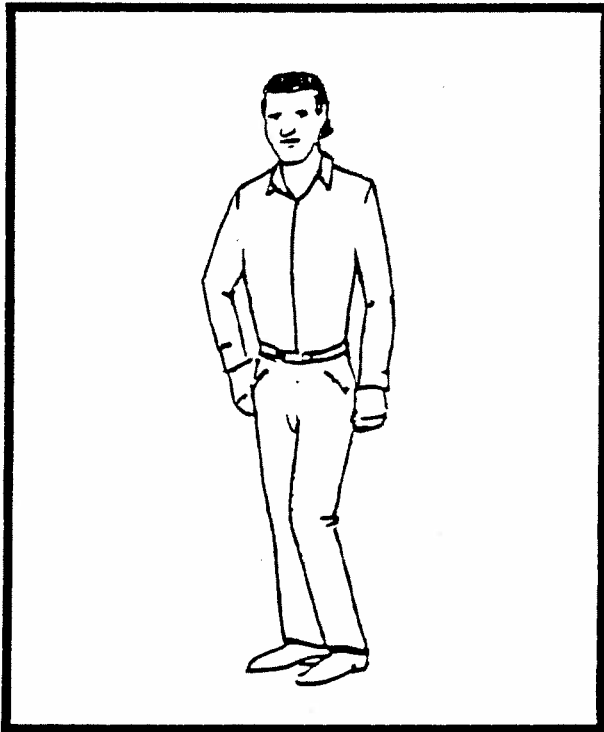

2

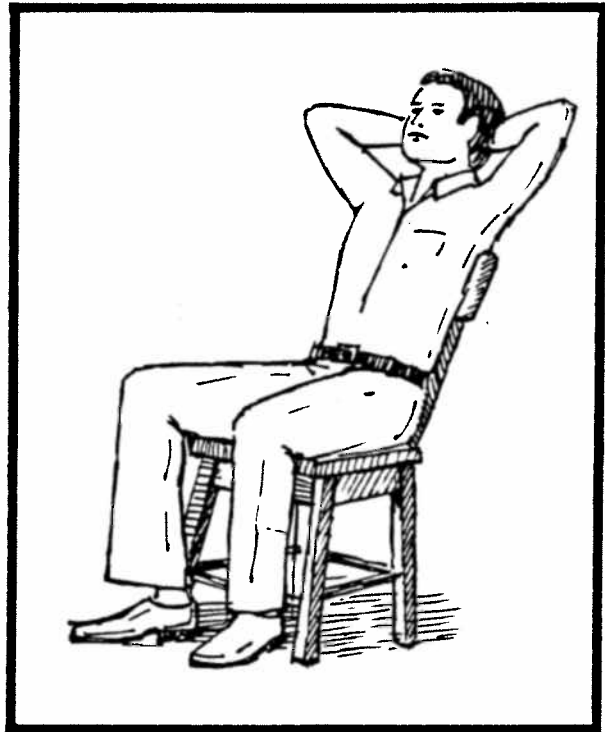

3

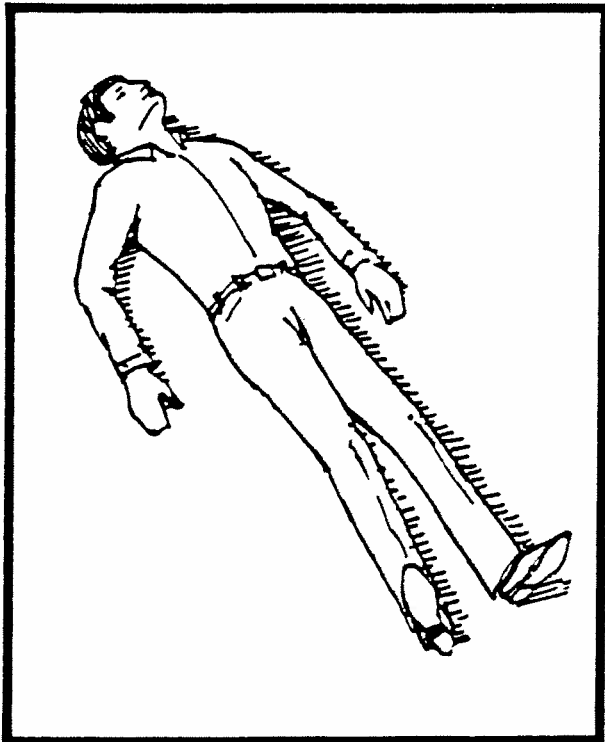

4



Esempio

1

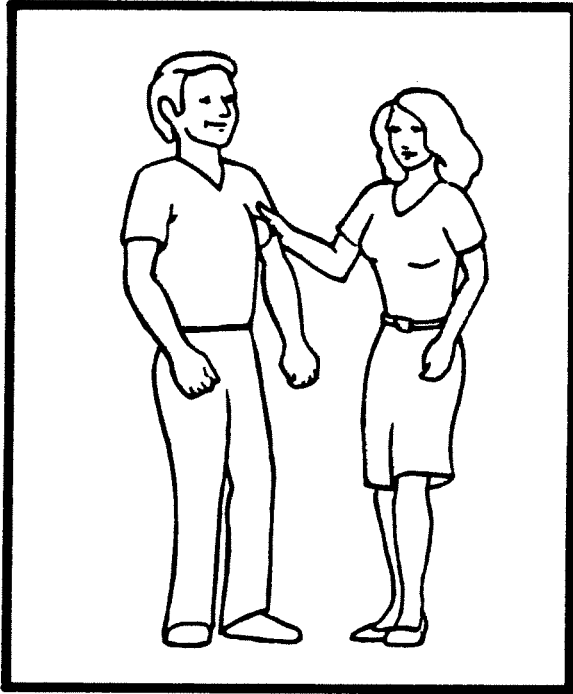

2

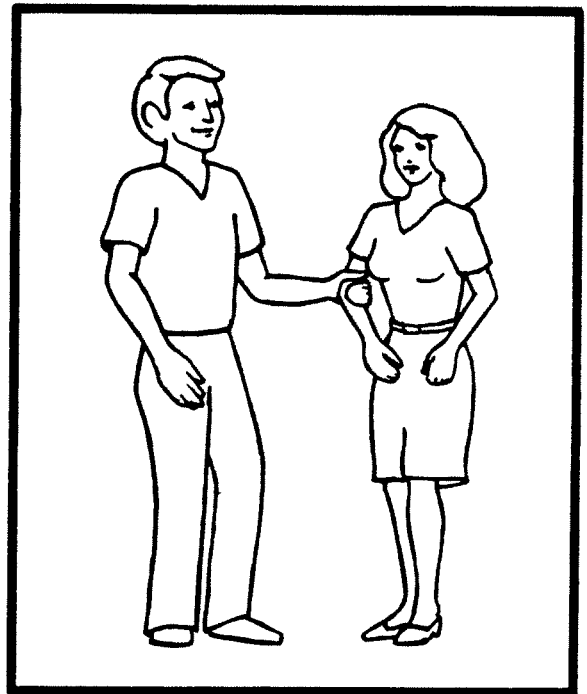

3

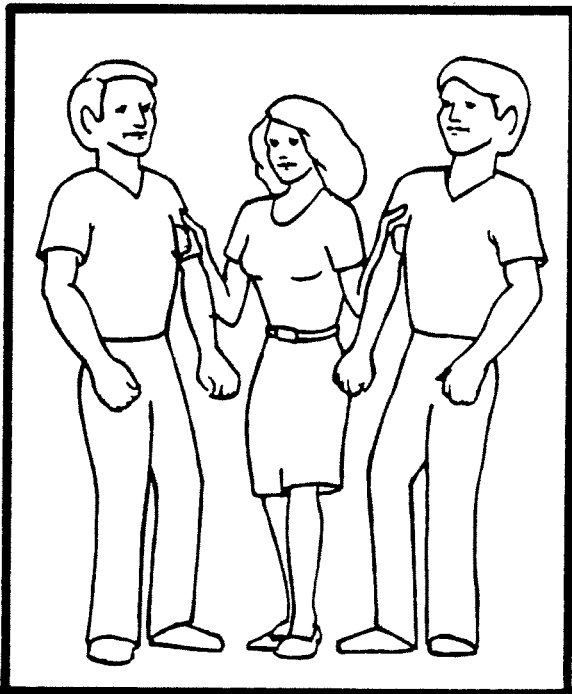

4

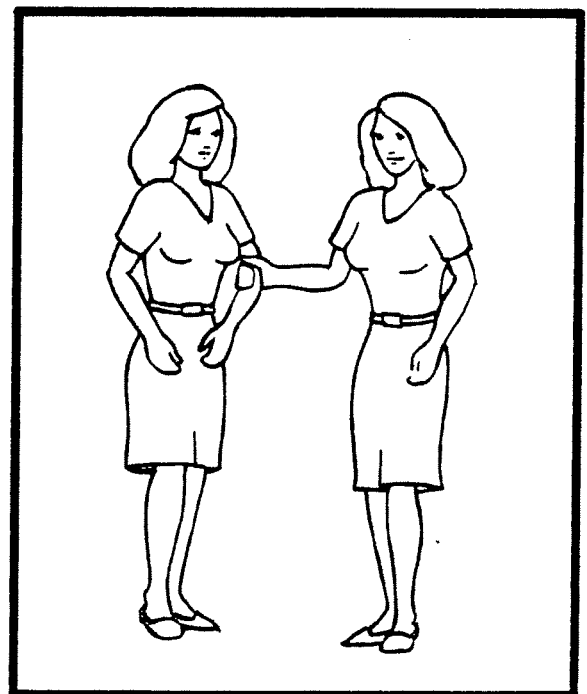

1

1

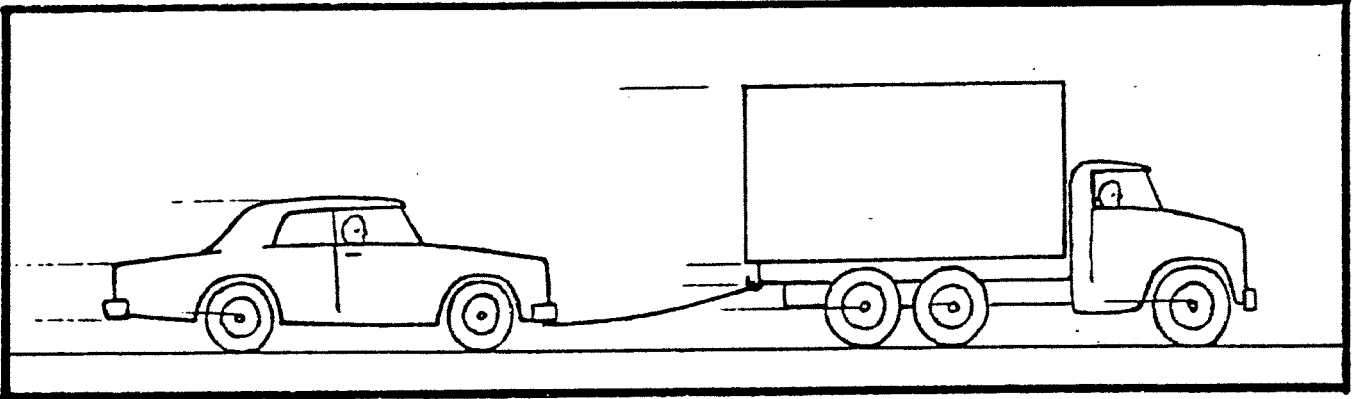

2

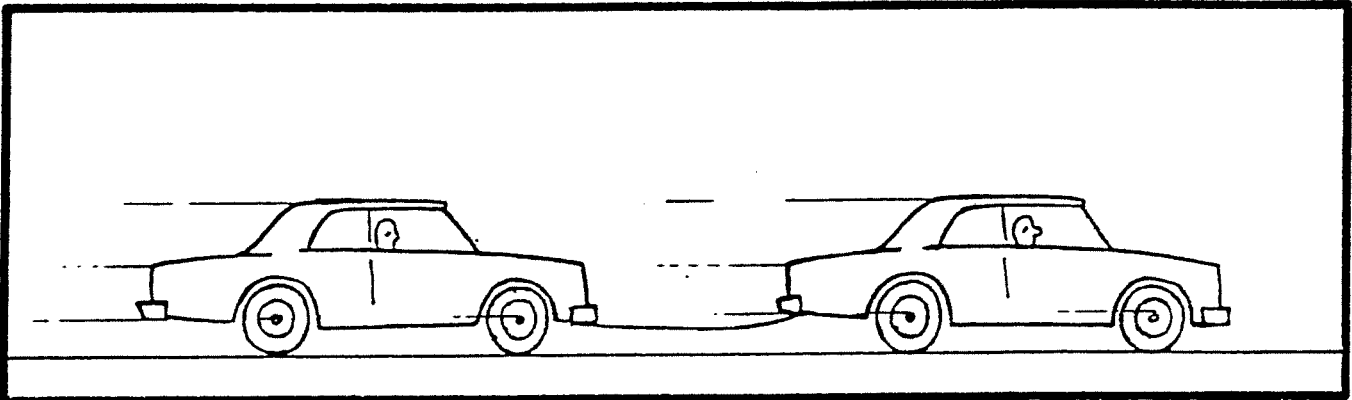

3

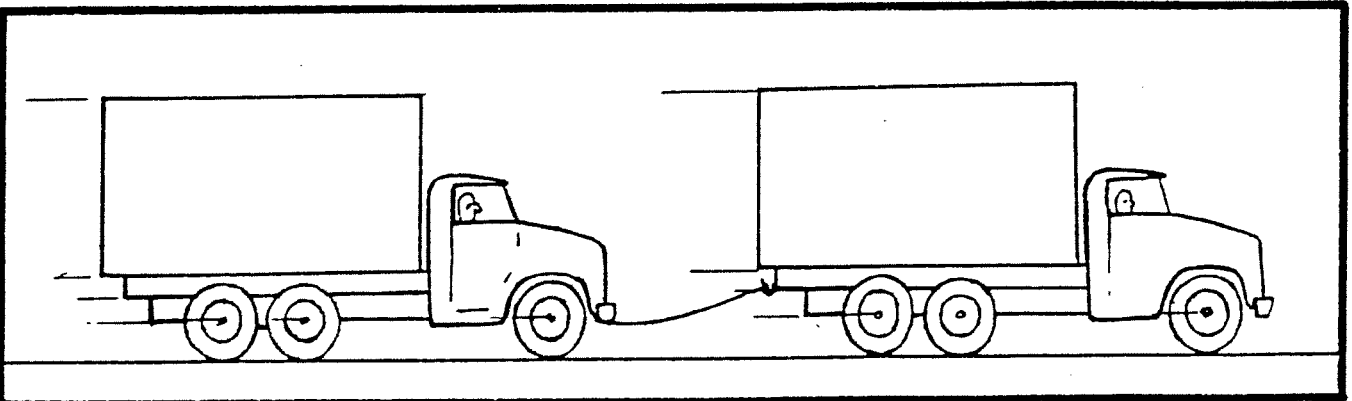

4

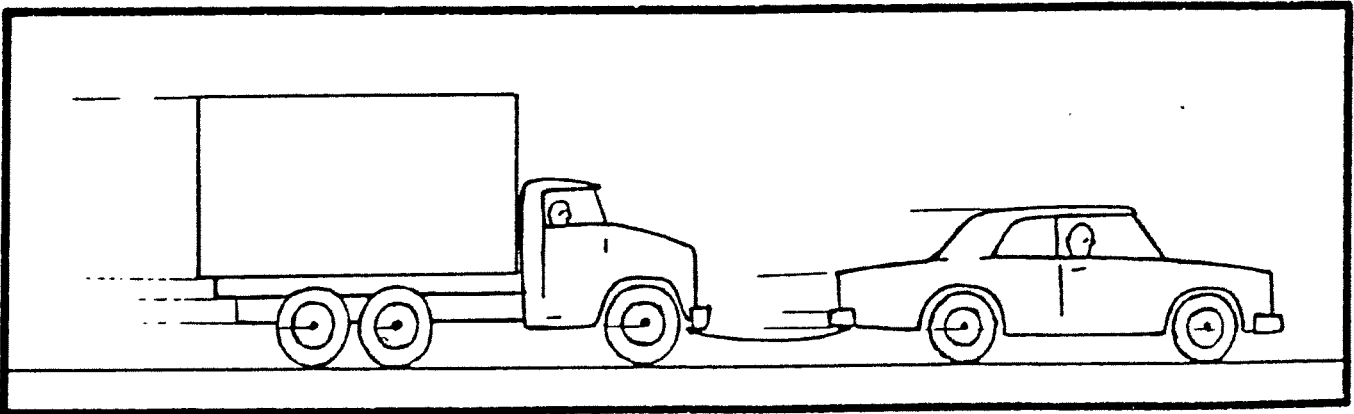

2

1



2

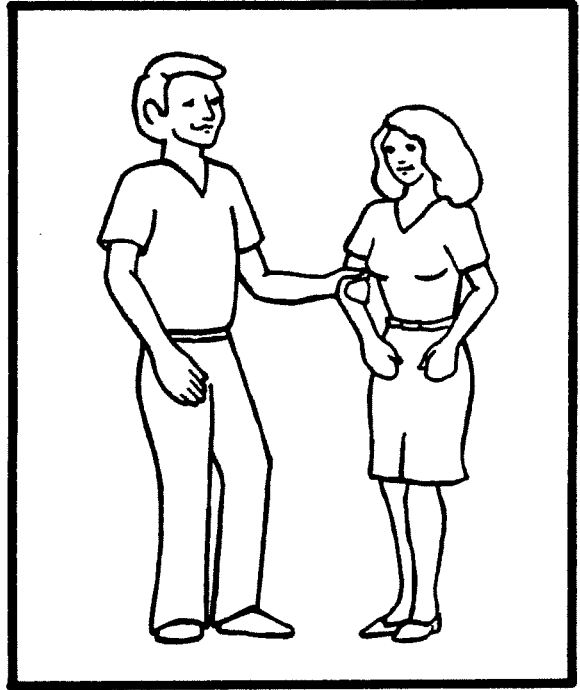

3

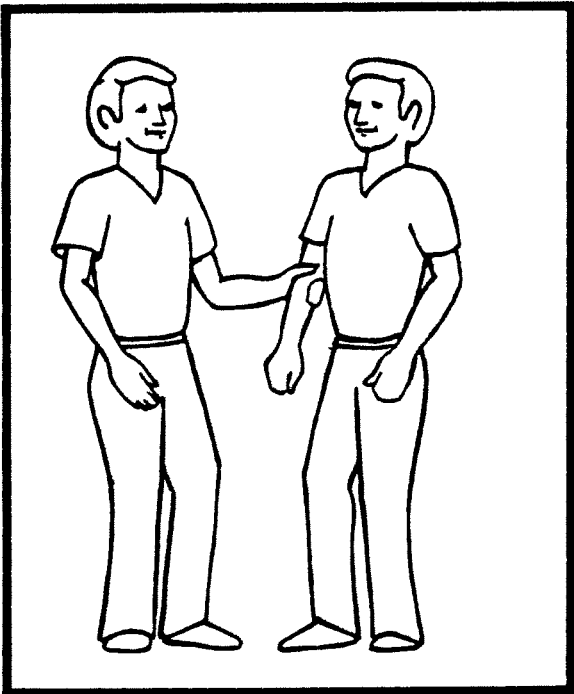

4

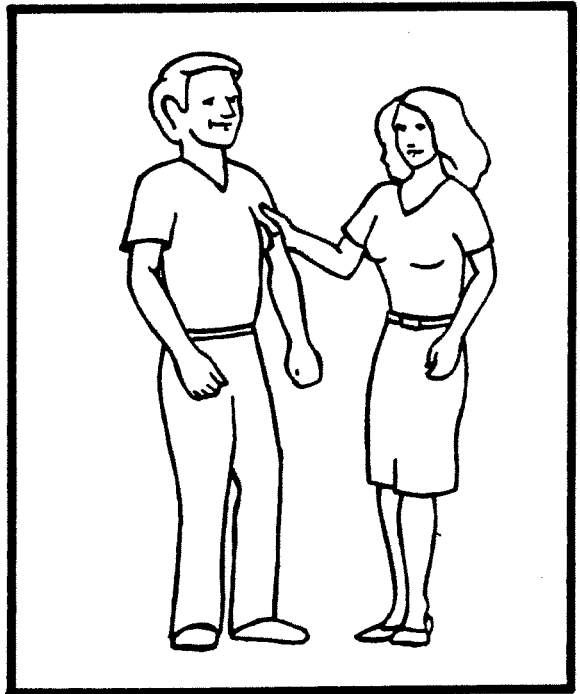

3

1

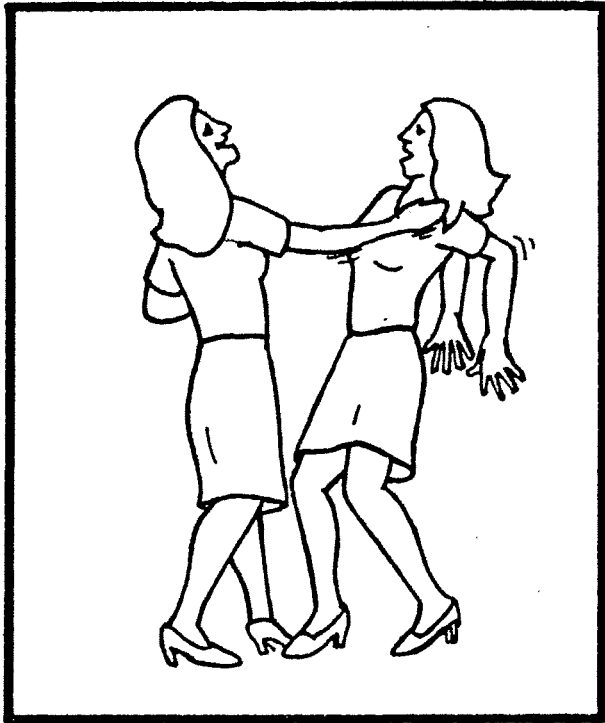

2

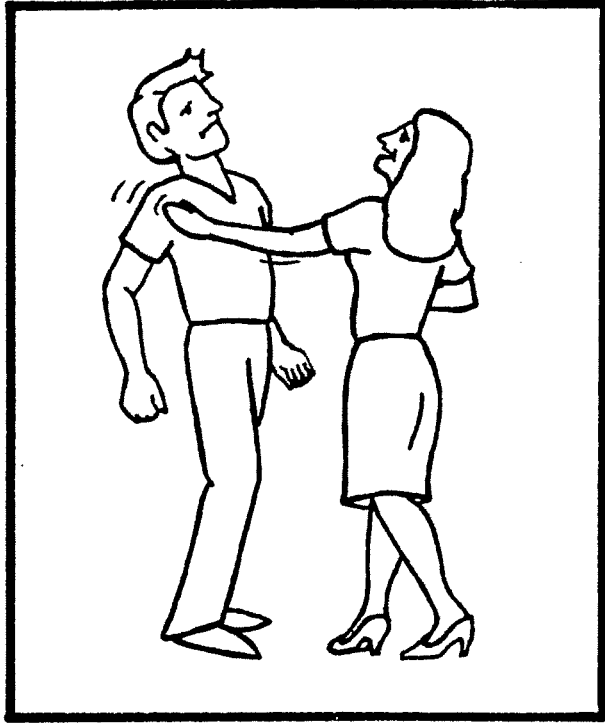

3

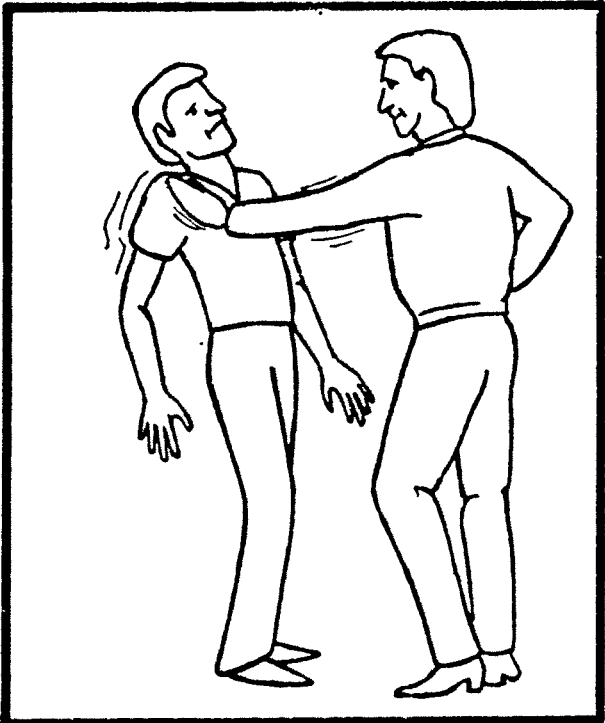

4

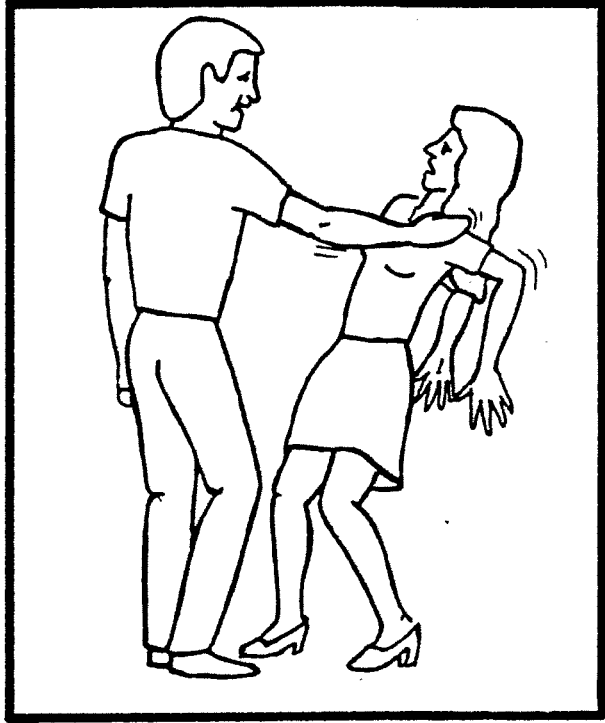

1

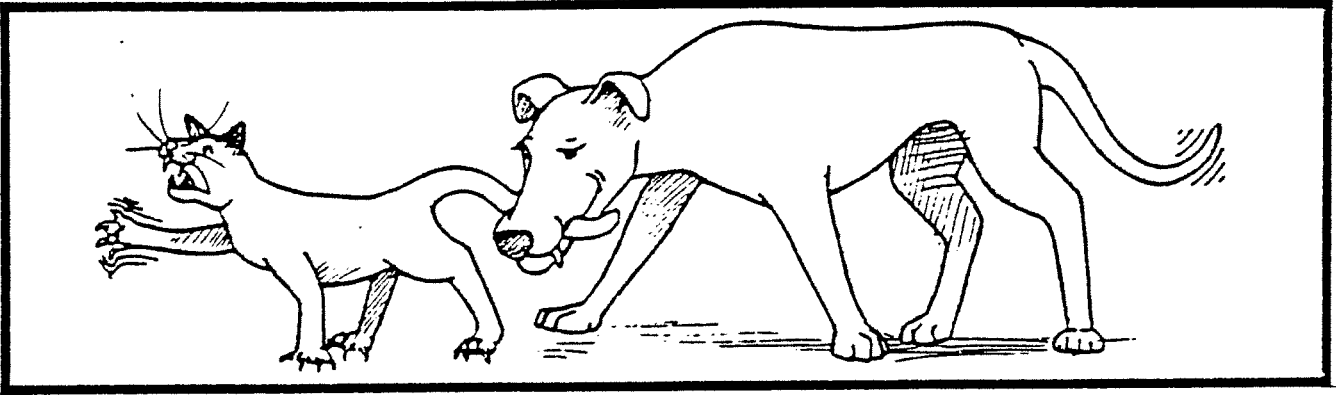

2

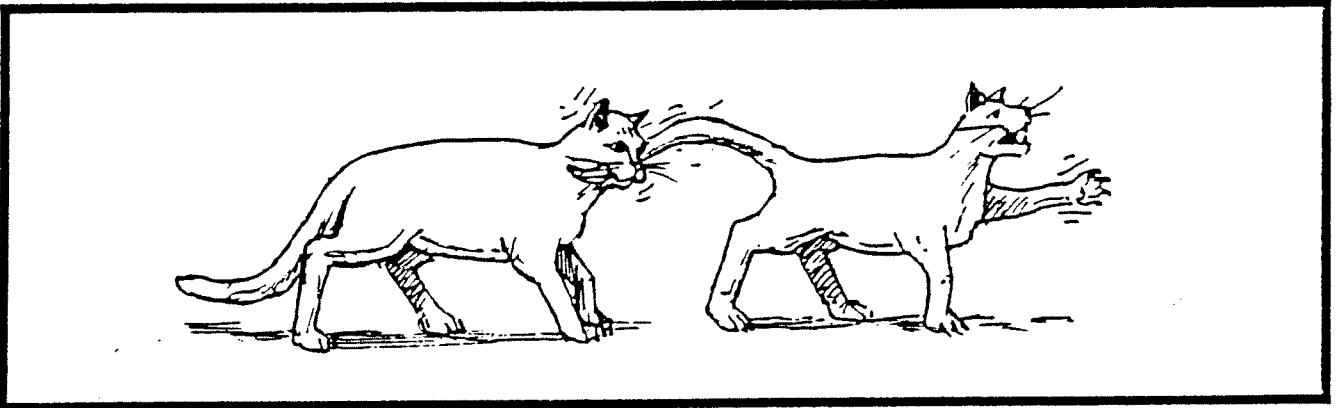

3

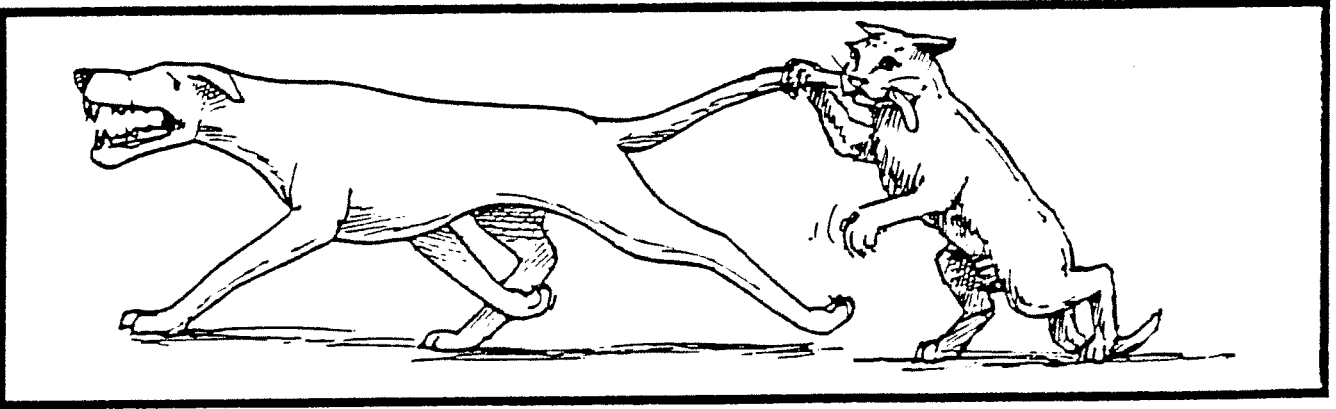

4

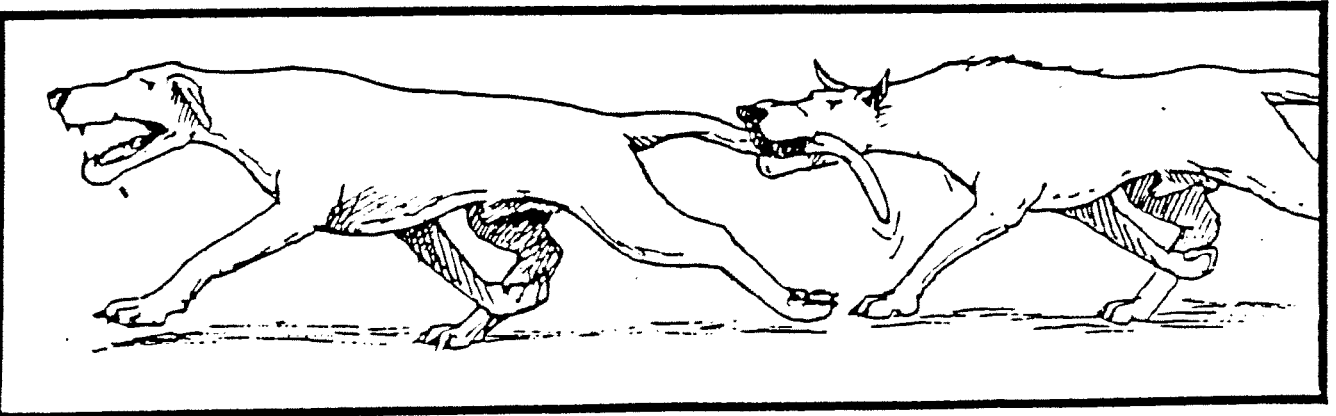

1

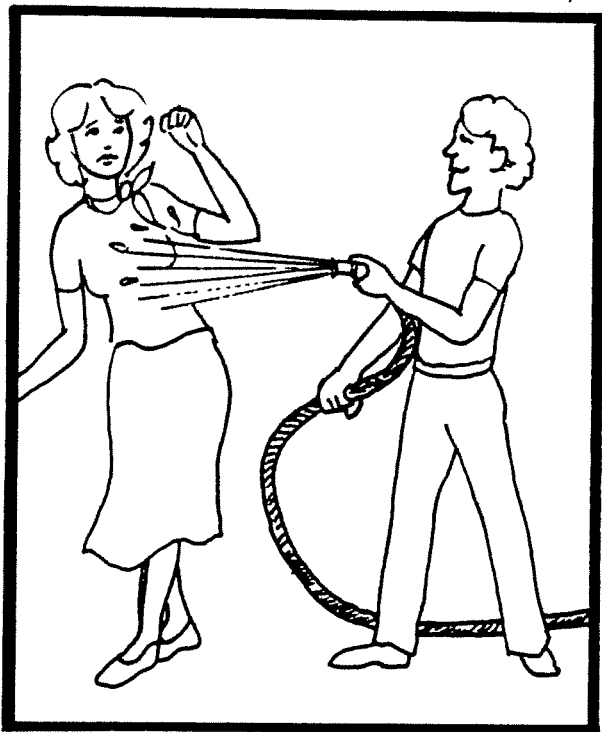

2

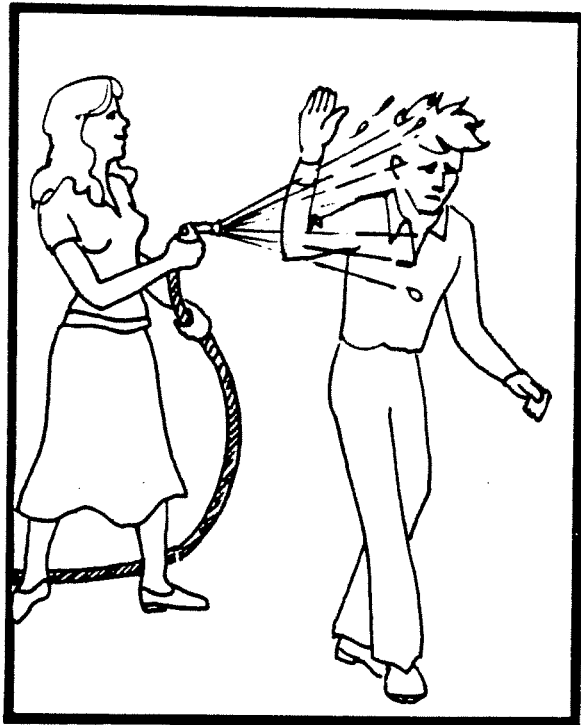

3

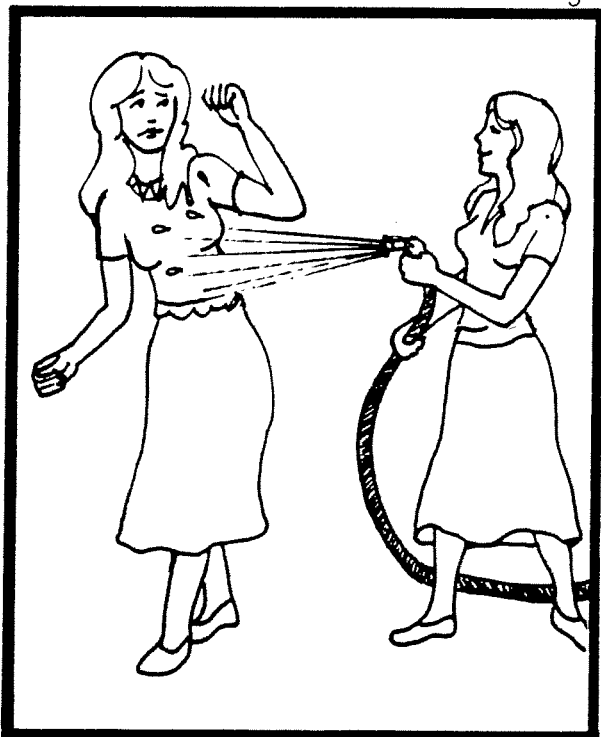

4

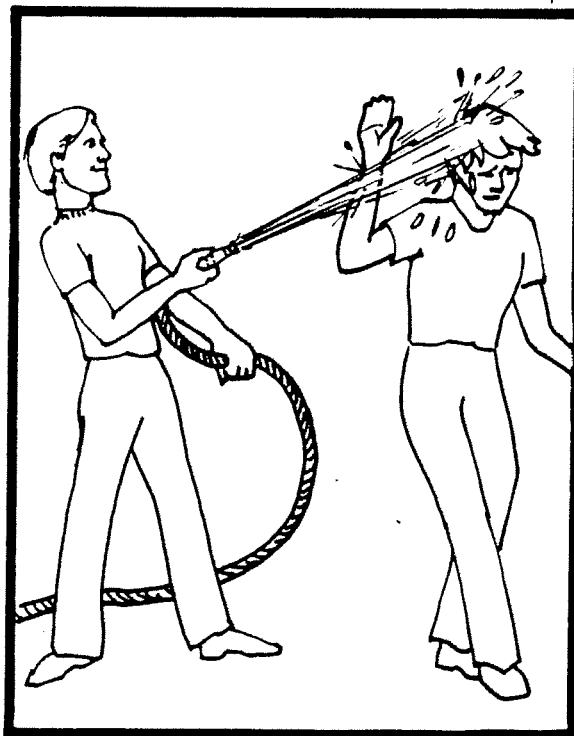

1

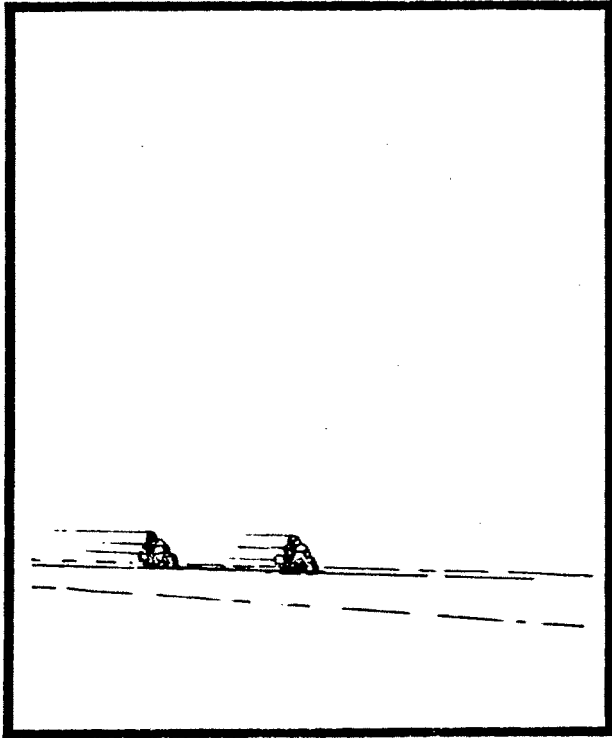

2

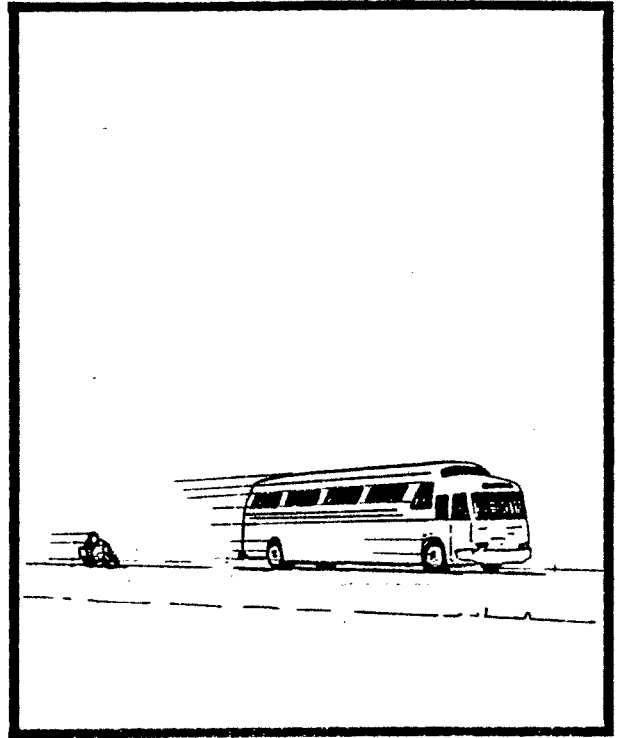

3

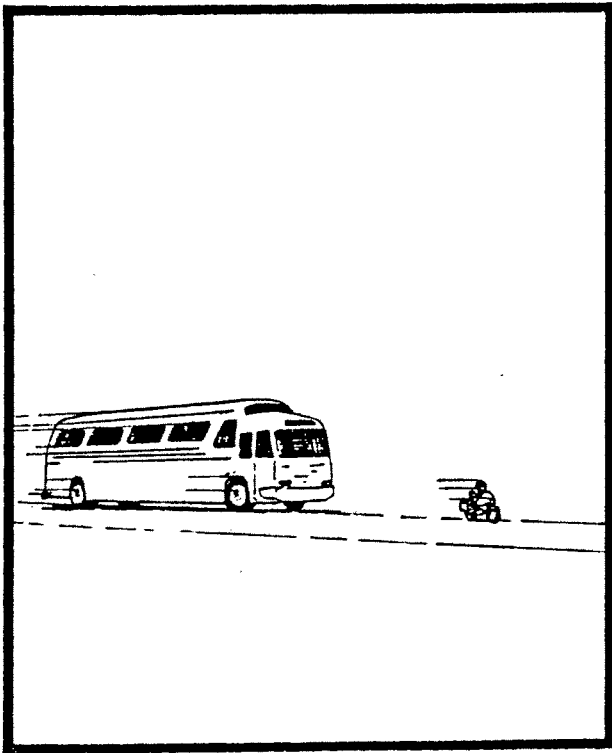

4



7

1

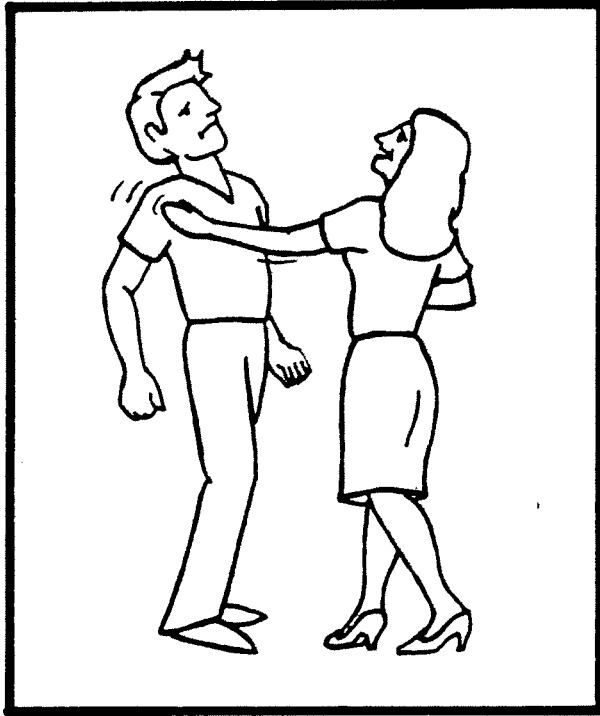

2

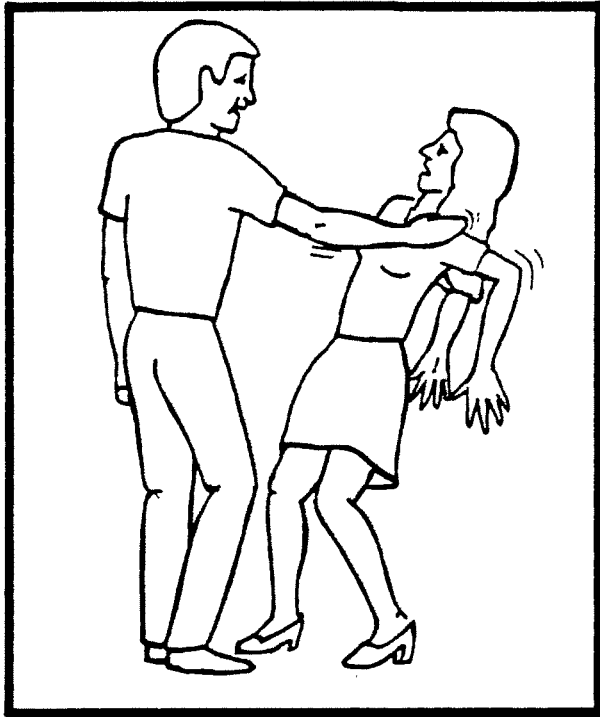

8

1

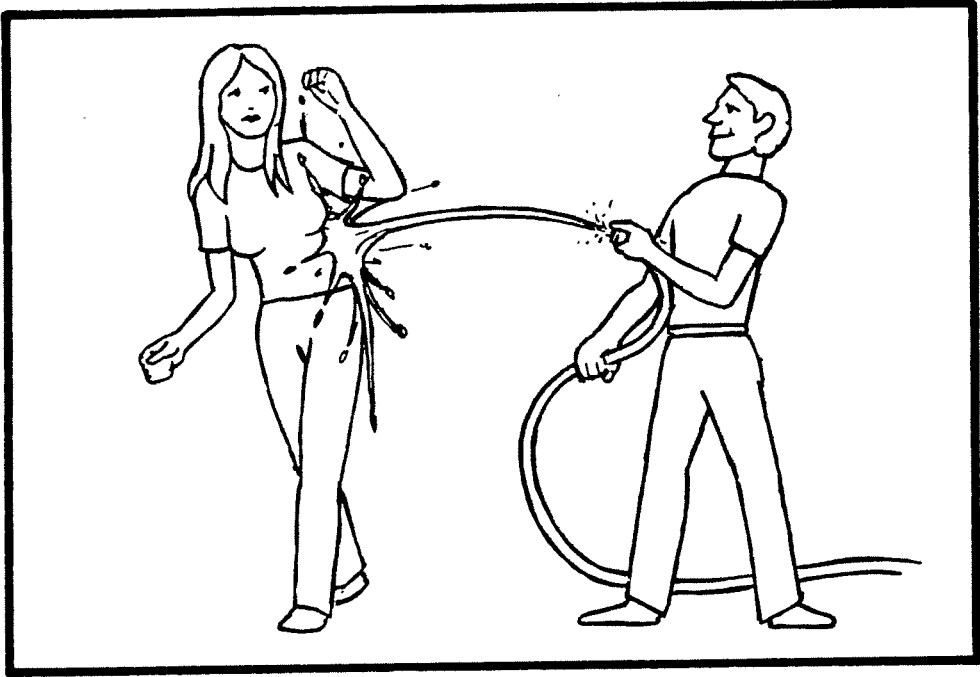

2

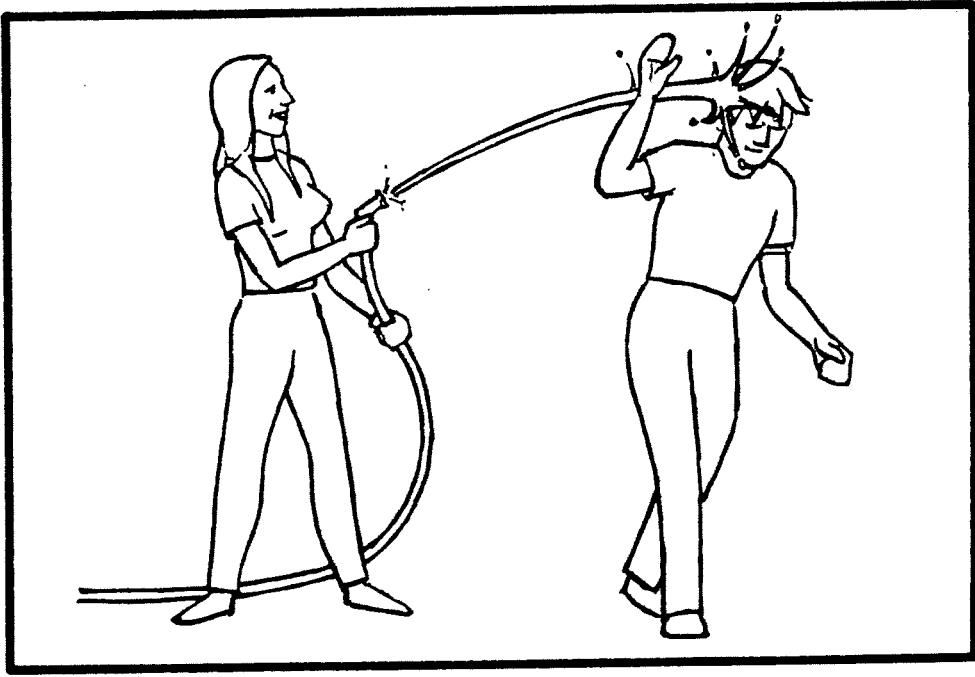

9

1

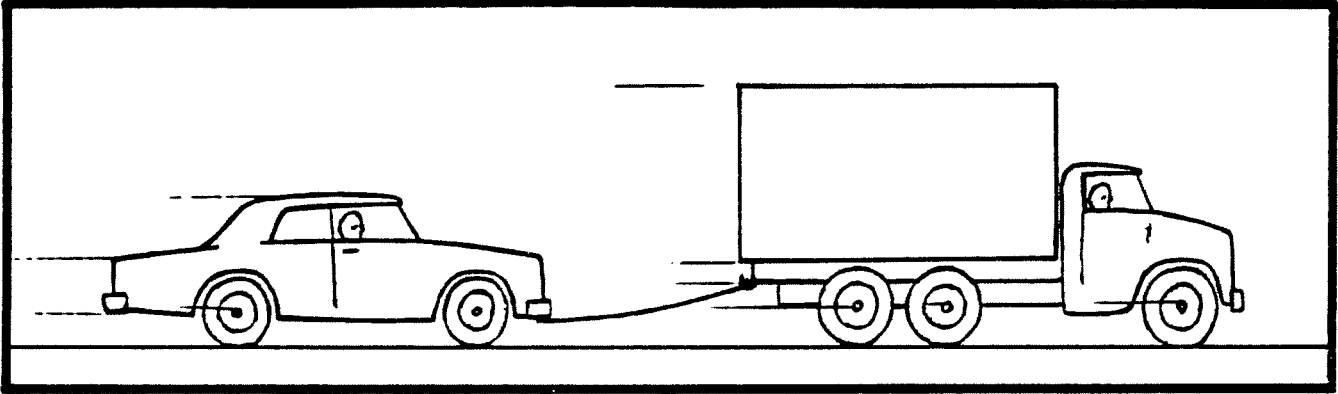

2

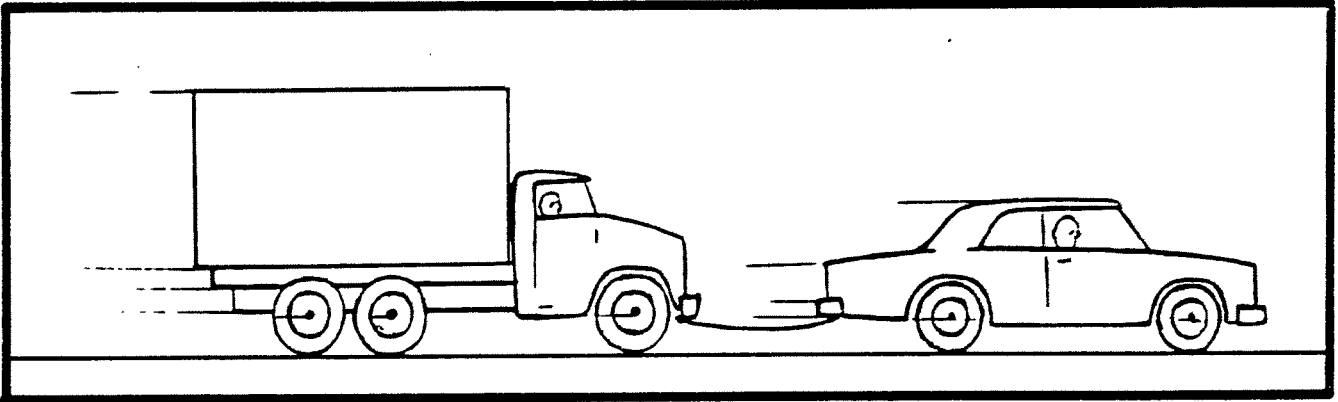

1



2

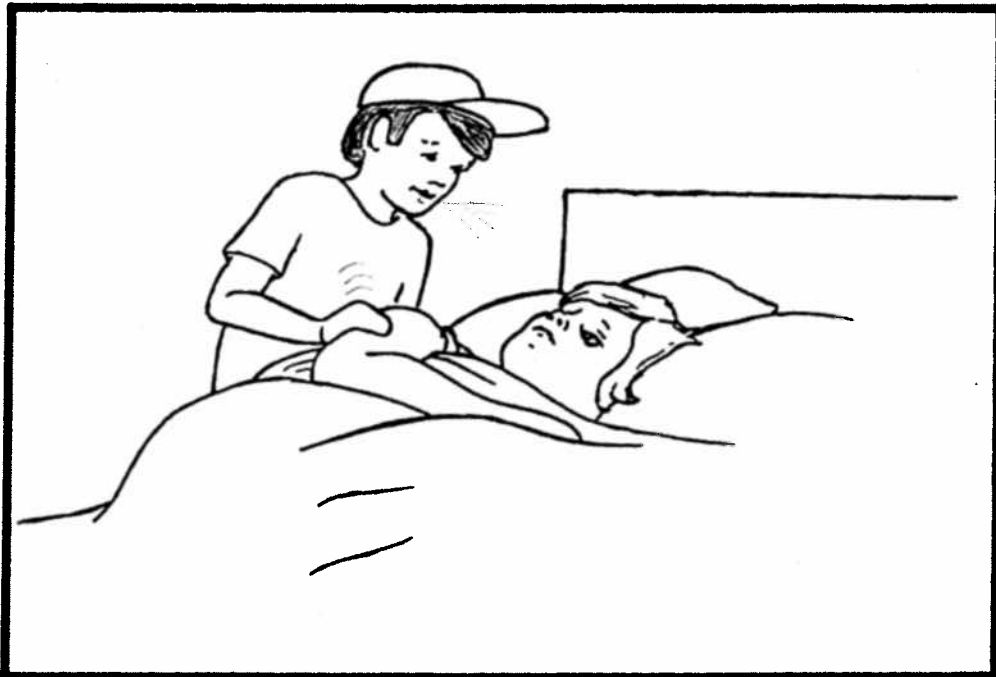

1

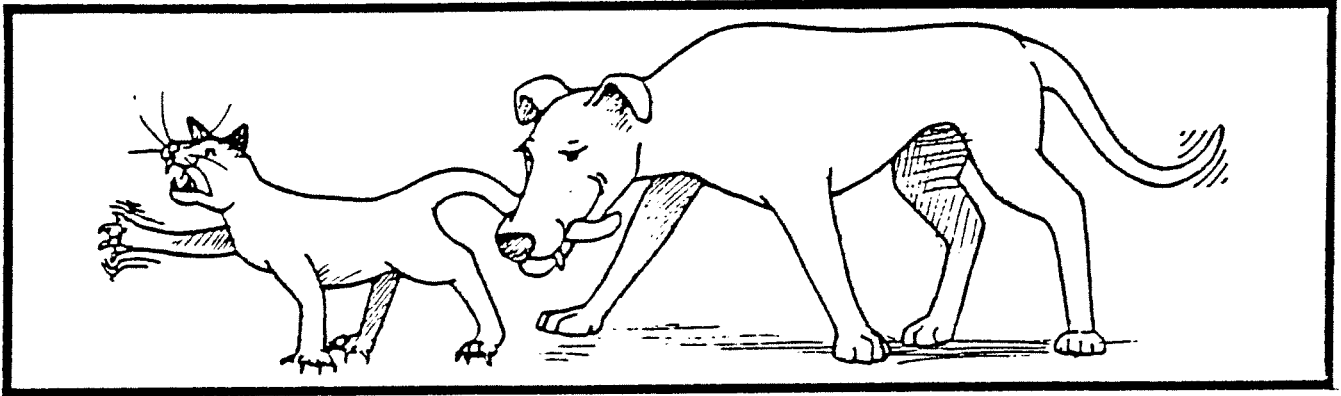

2

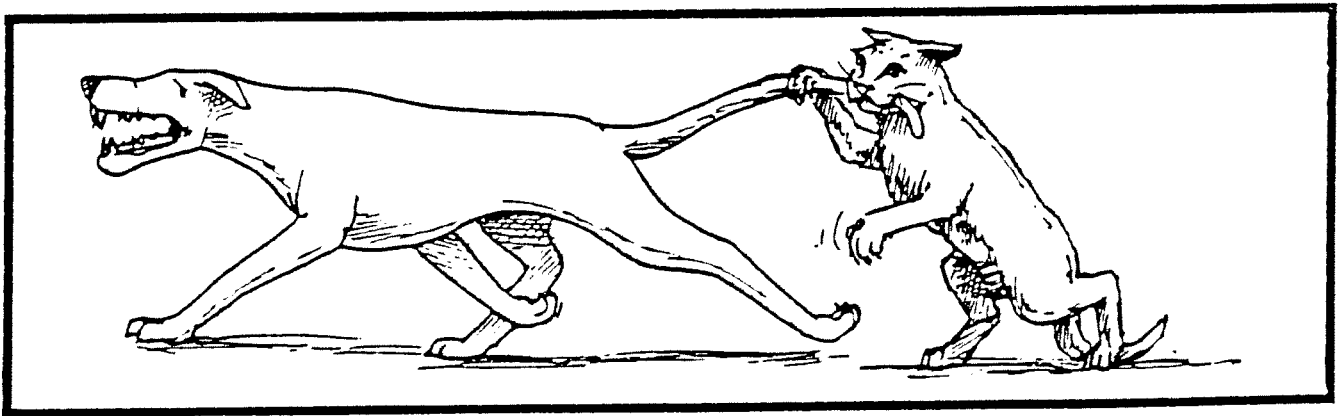

12

1



2



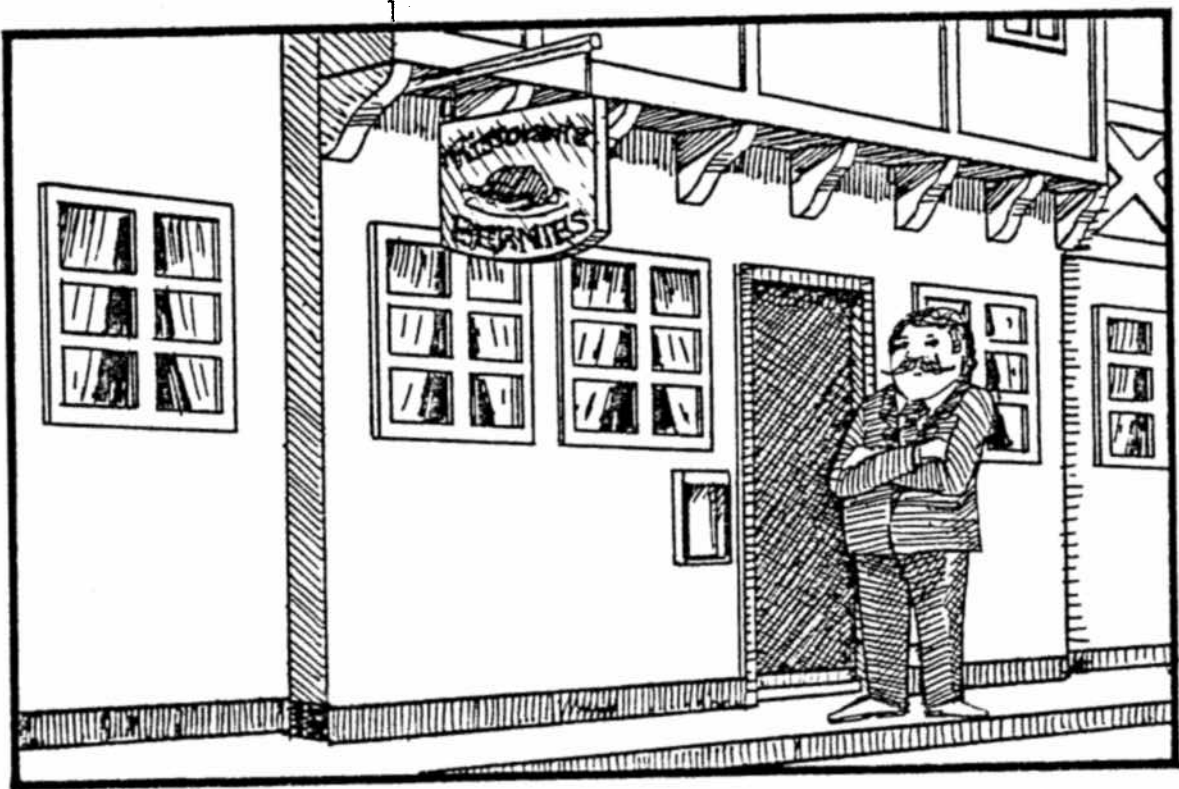



1

2

1

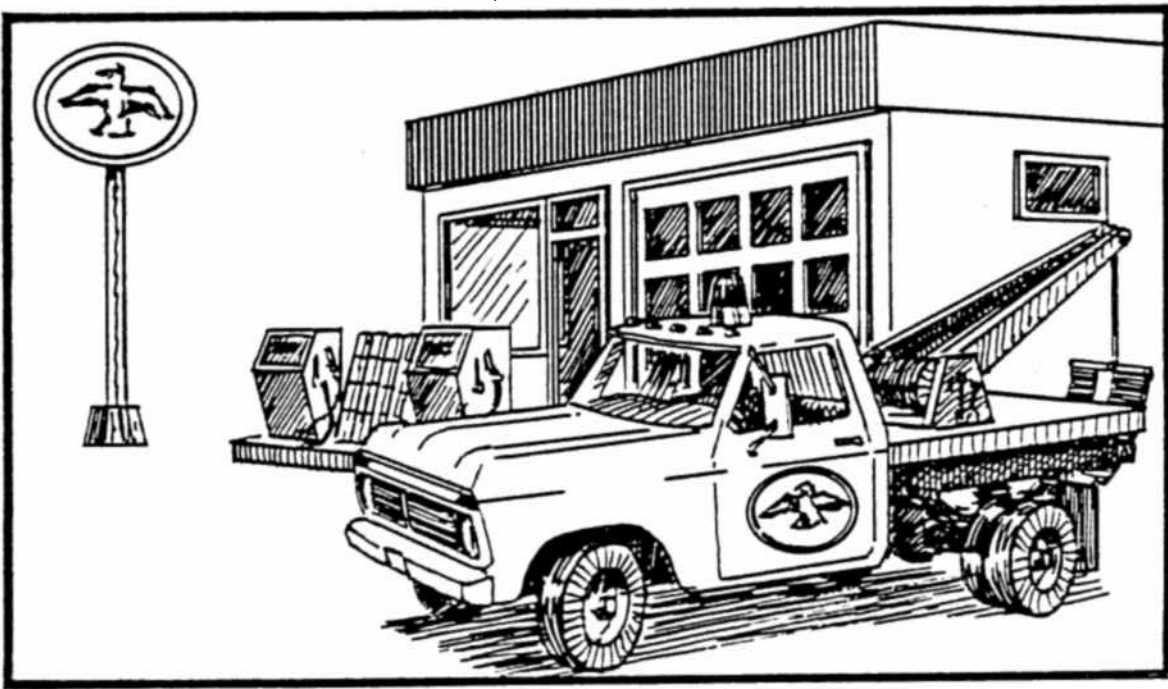

2

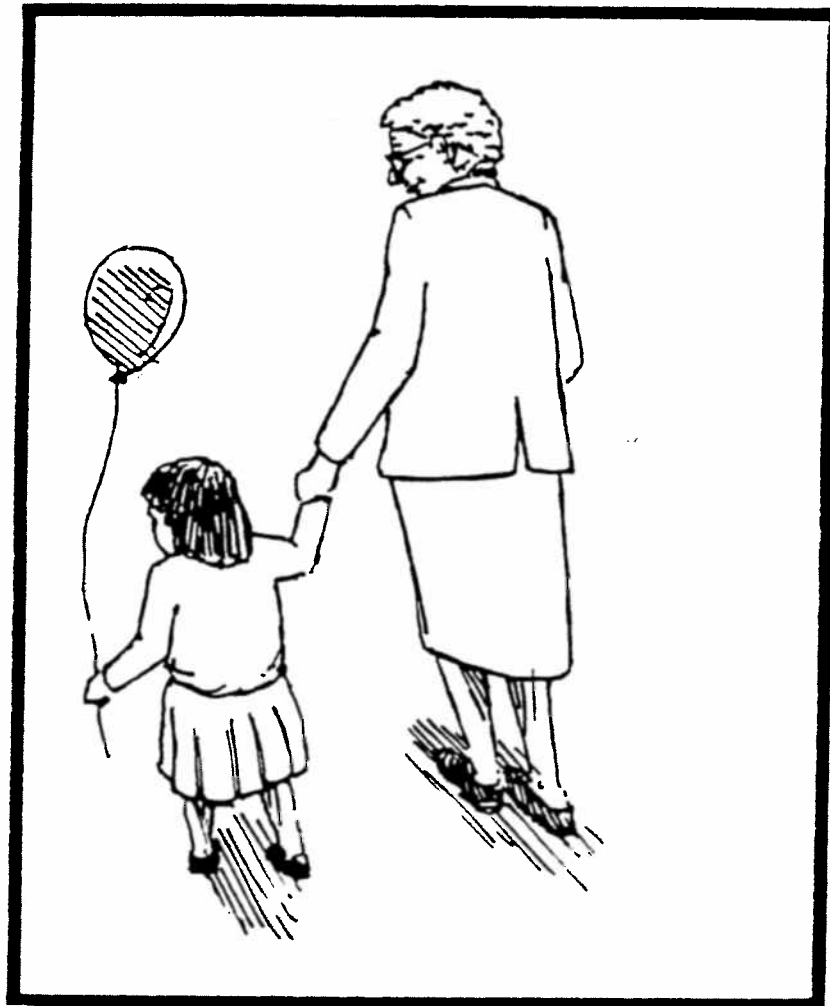

2

1

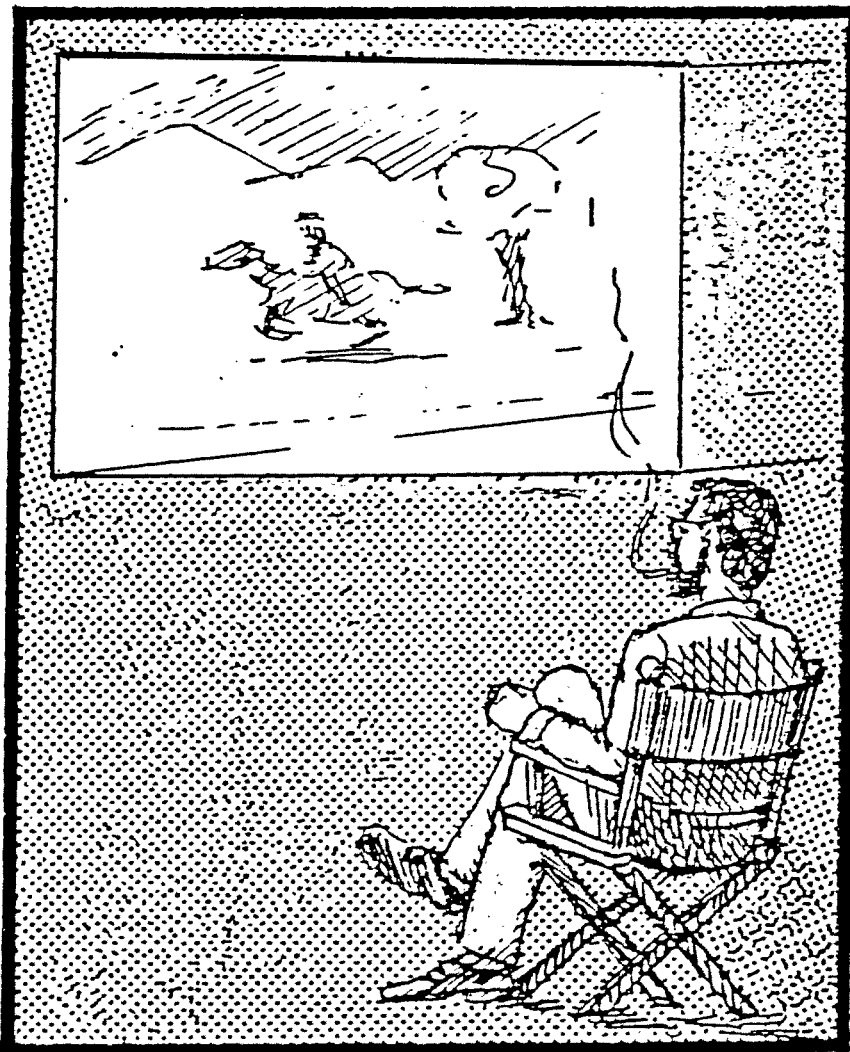

2



1

2

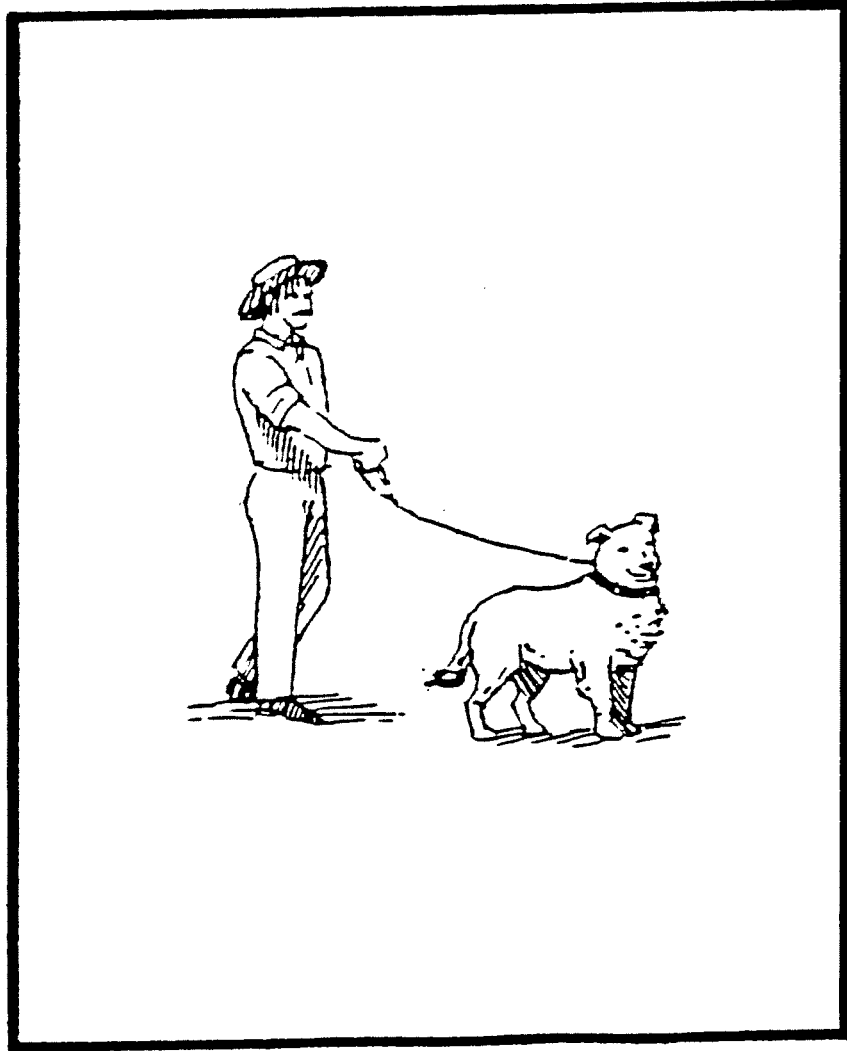

1

2

1

2

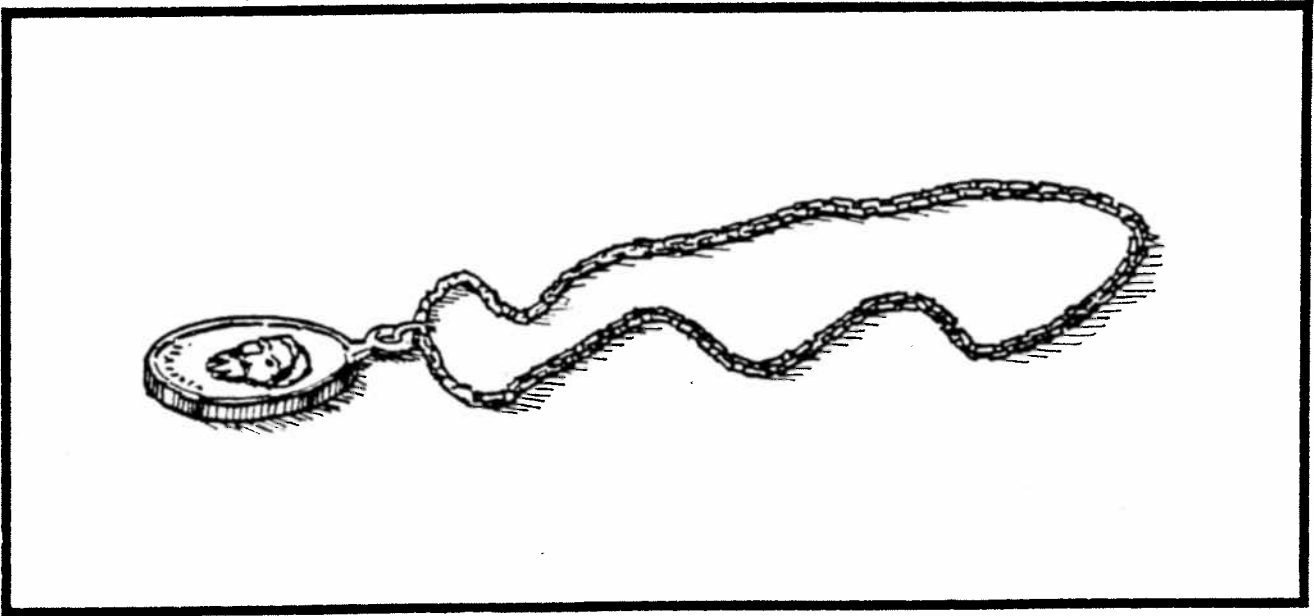

1

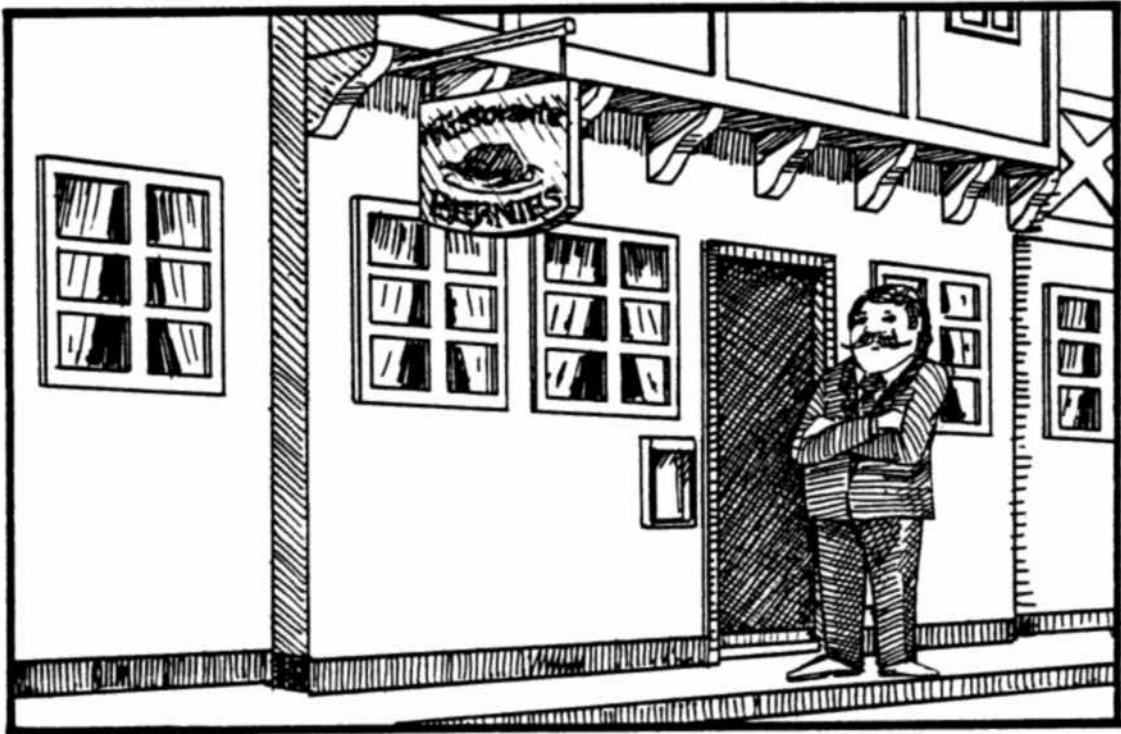

2

22



1

2

1

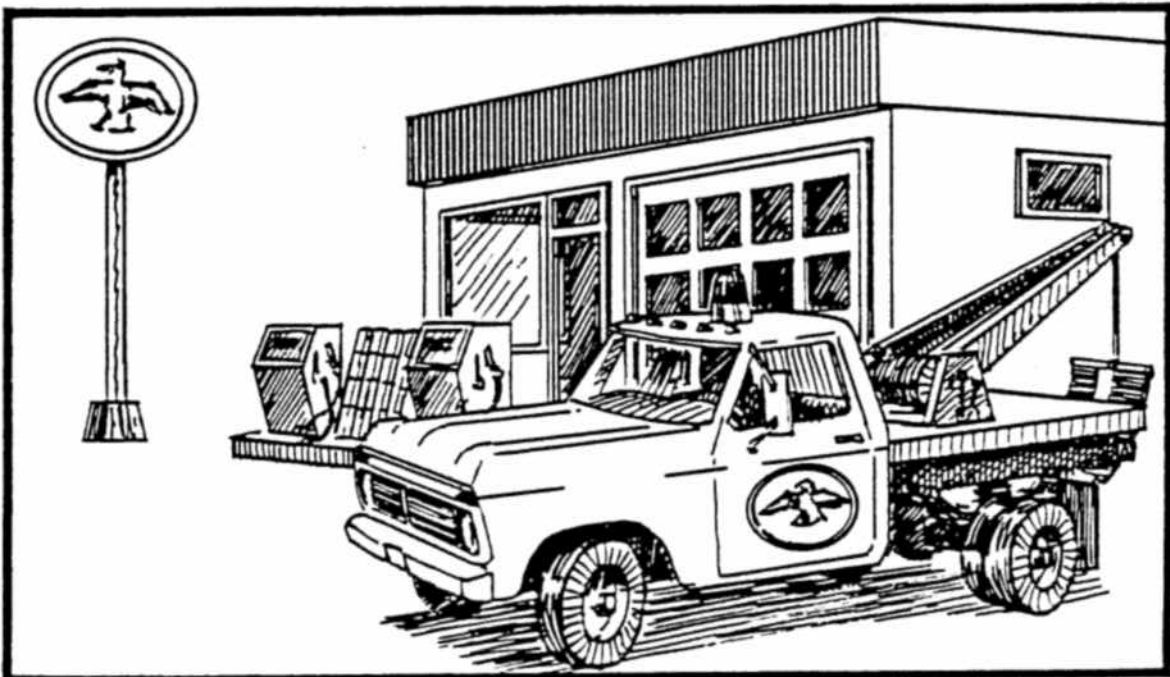

2

24



1

2

1

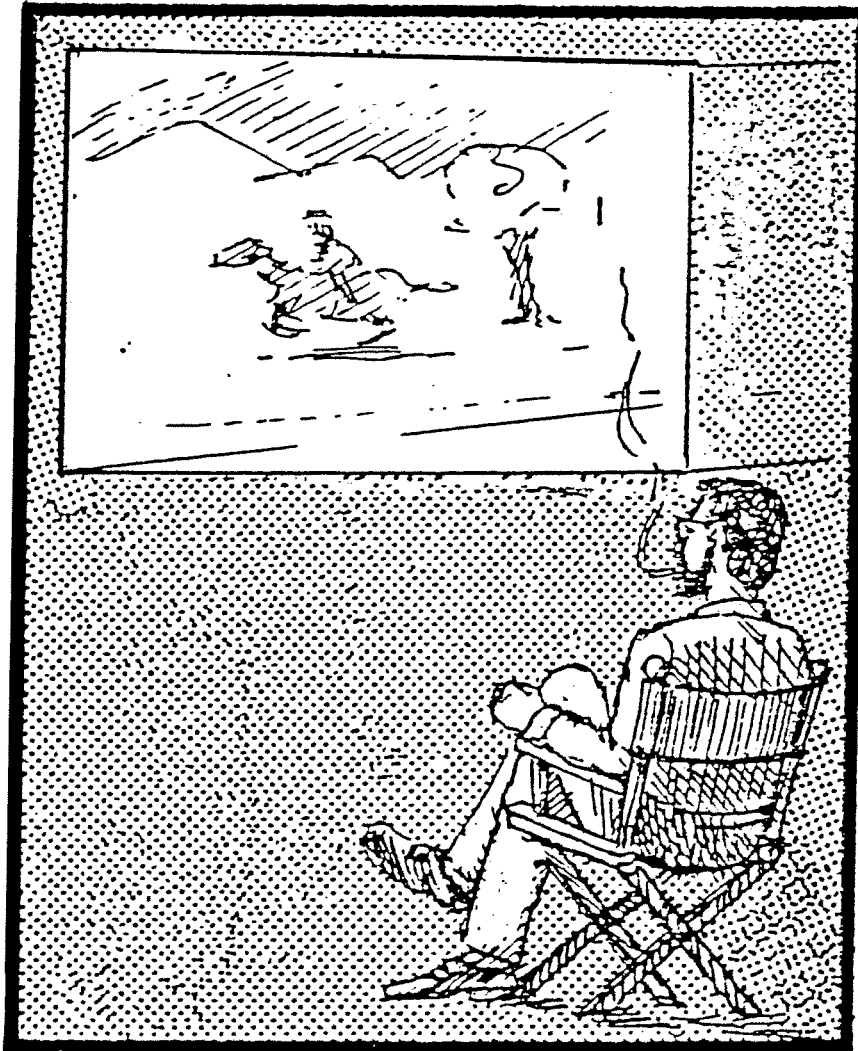

2



1

2

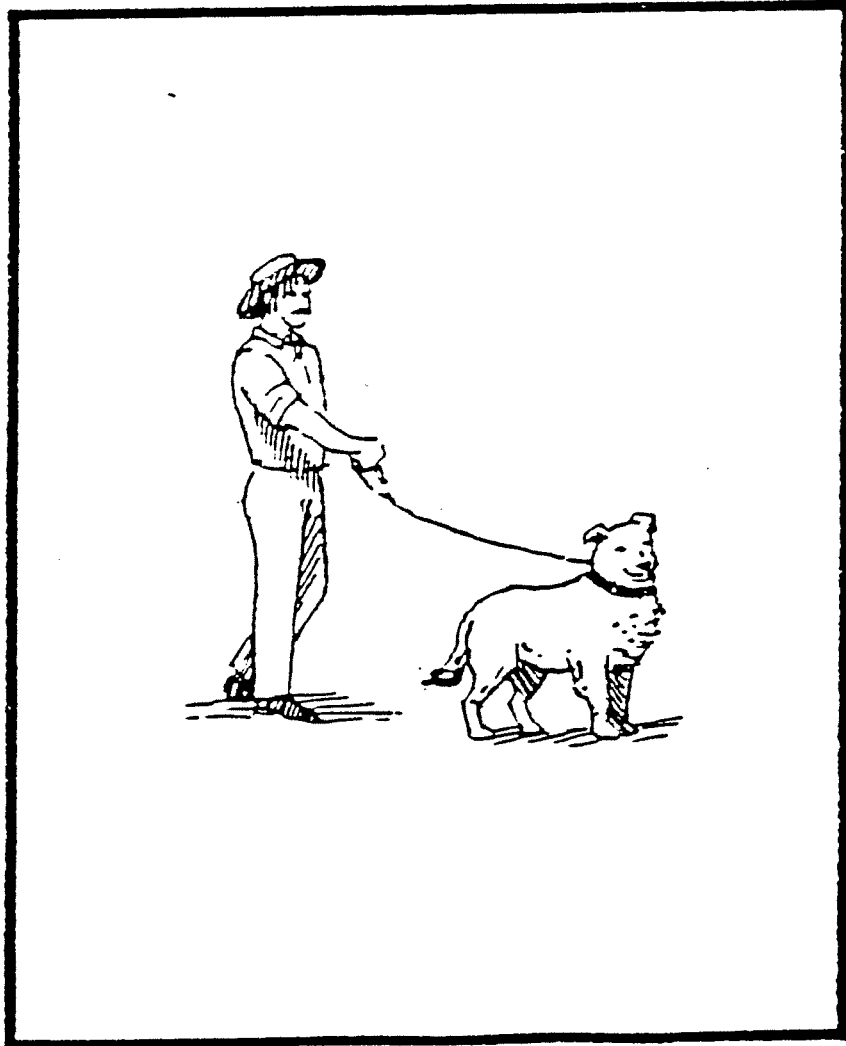

1

2

1

2

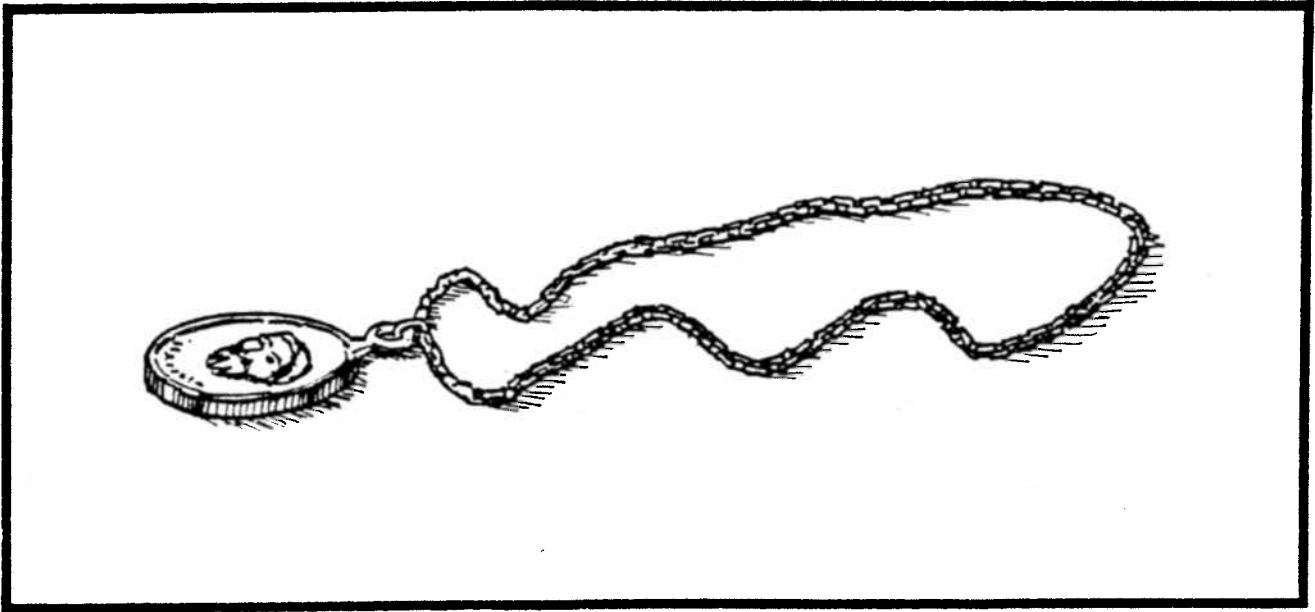



velo

quaglia

vino

coro

callo

lana

ponte

pappa

tacco

fango

Il ragazzo tiene la ragazza.

Lei lo spinge.

Il gatto é morso dal cane.

È il camion che tira la macchina.

Il ragazzo non spinge la ragazza.

Il camion non é tirato dalla macchina.

È il cane che il gatto morde.

Lei la tiene.

La ragazza é spinta dal ragazzo.

Il ragazzo non é bagnato dalla ragazza.

Un uomo andò a pescare con suo nipote. Al lago presero due carpe. Di ritorno al villaggio si fermarono al mercato e scambiarono le carpe per una lepre.

monte

telo

sacco

ballo

cava

COMPrensione di testo scritto (Vocaboli)

velo

1



2

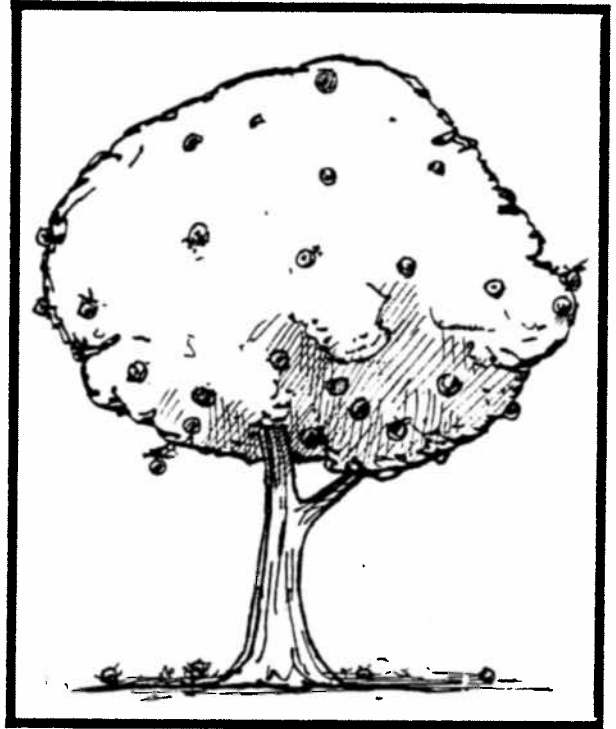

3

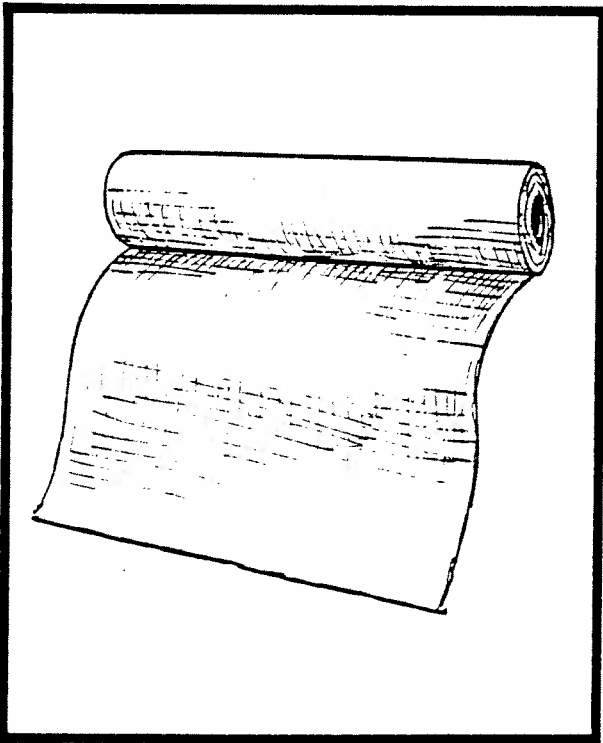

4

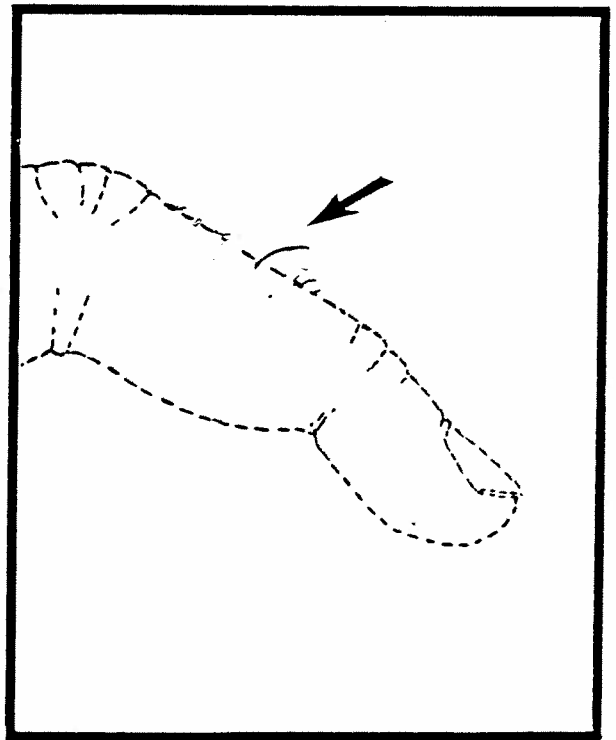

quaglia

1

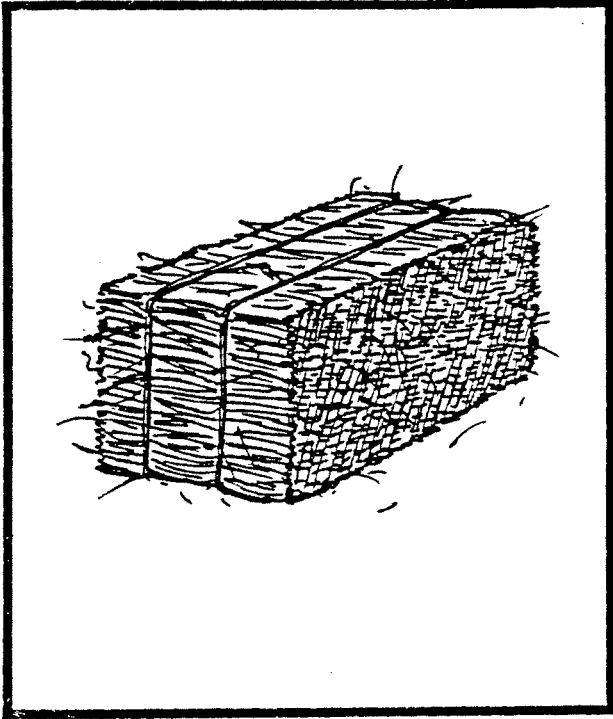

2

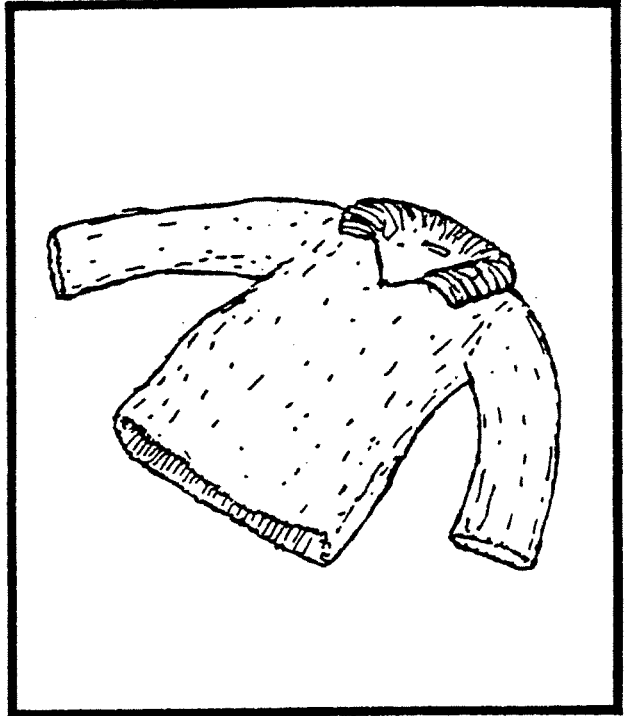

3

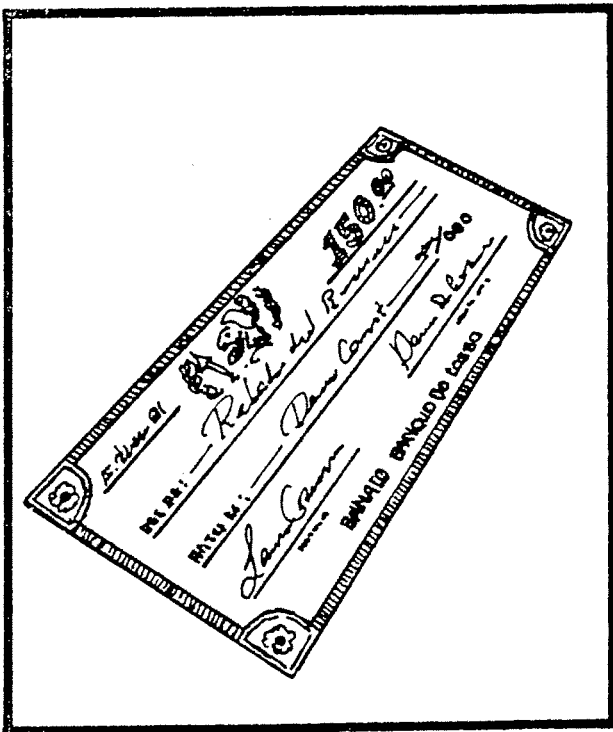

4

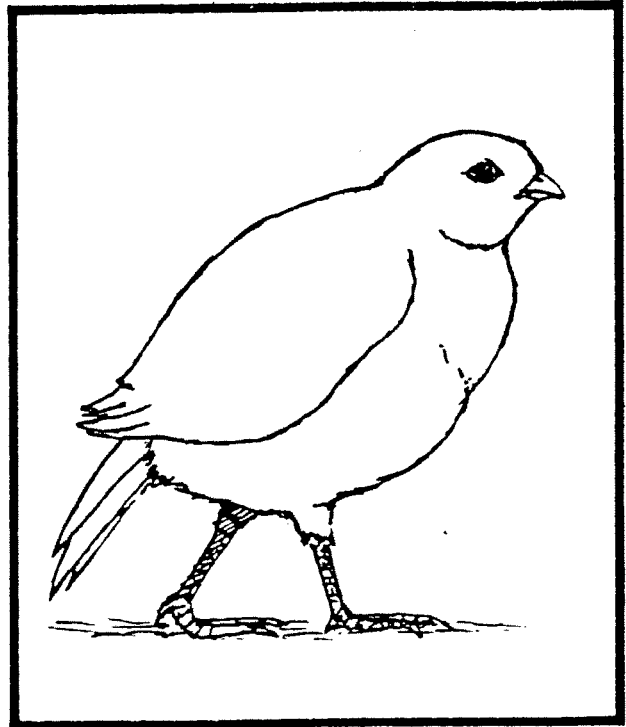

vino

1



2

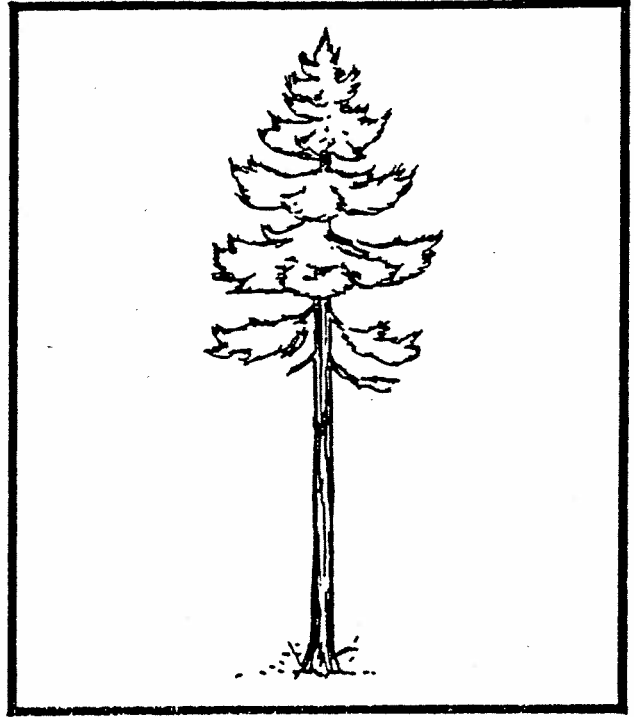

3

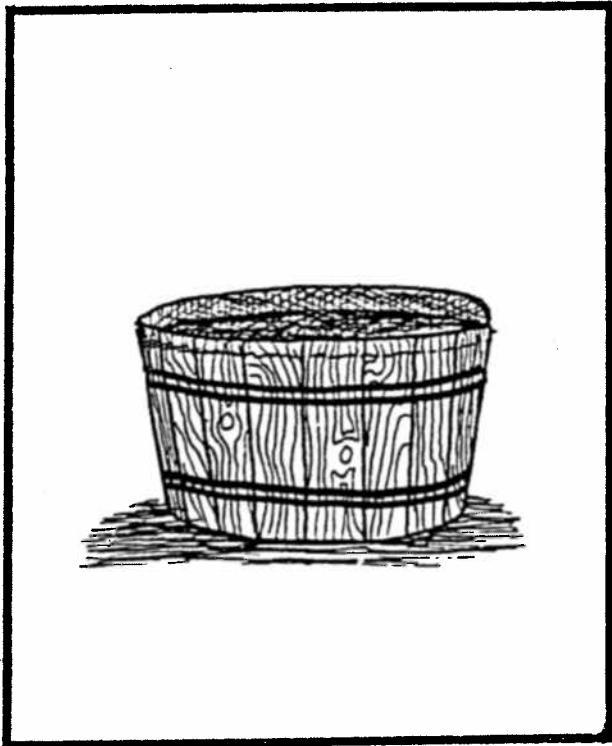

4

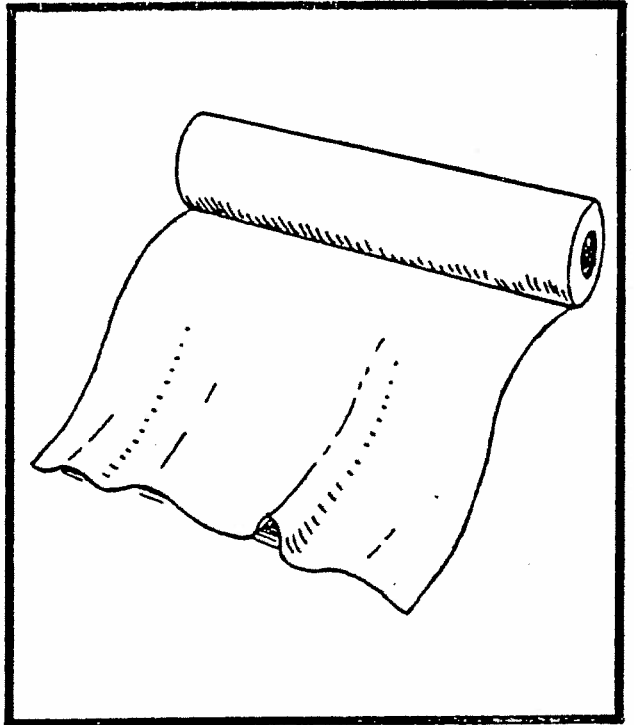

coro

1



2

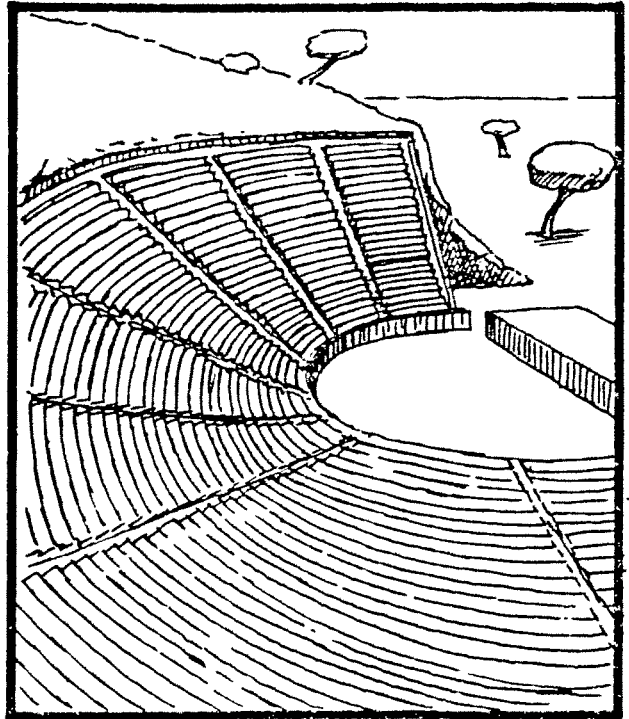

3



4

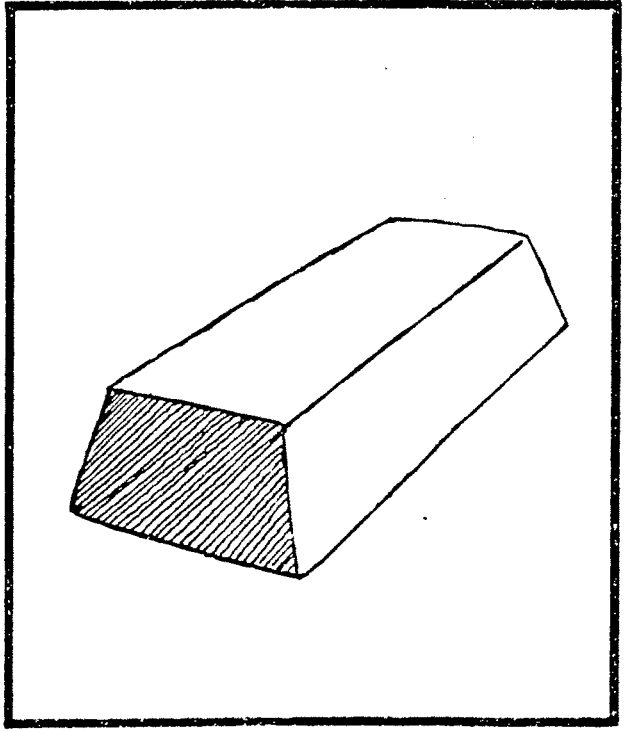

callo

1

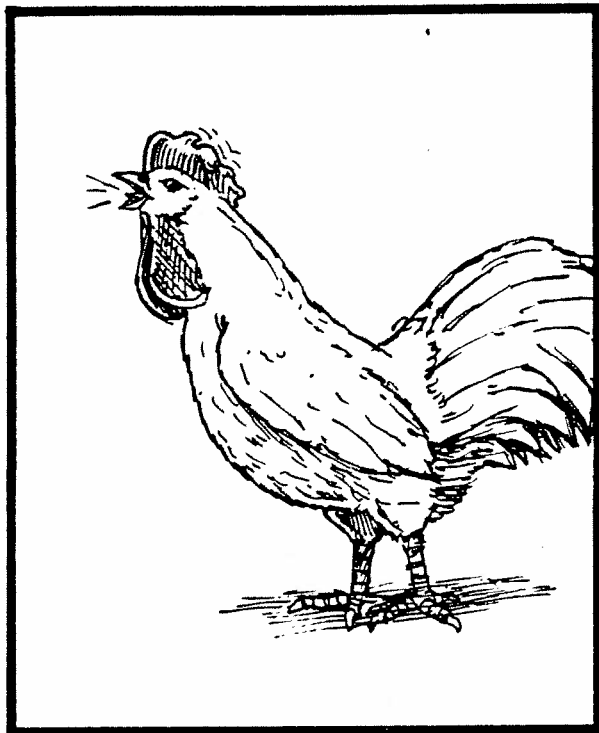

2

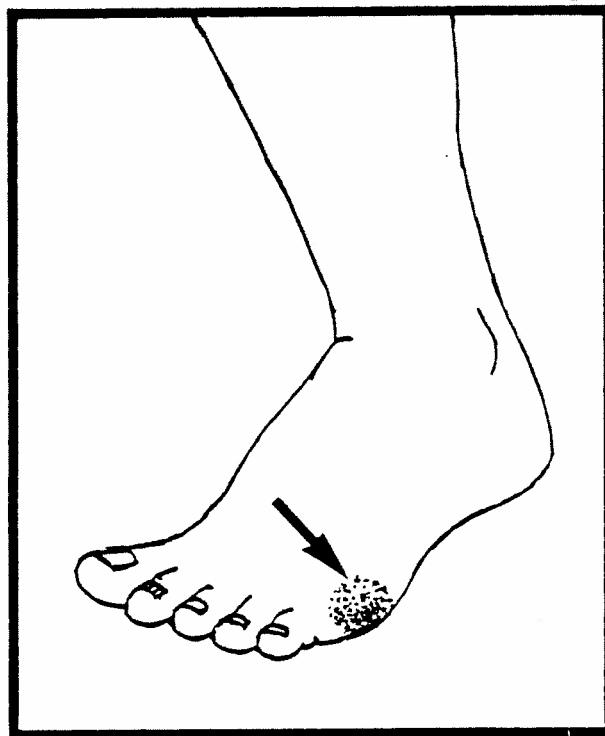

3



4

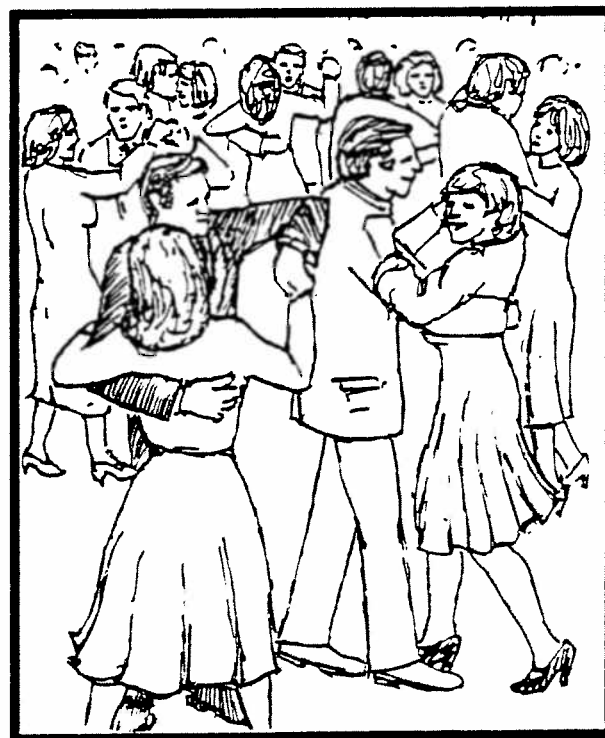

lana

1

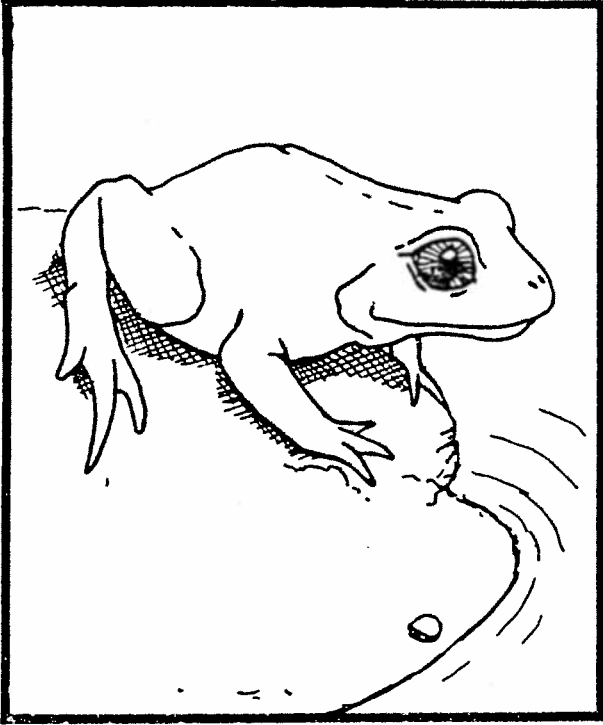

2

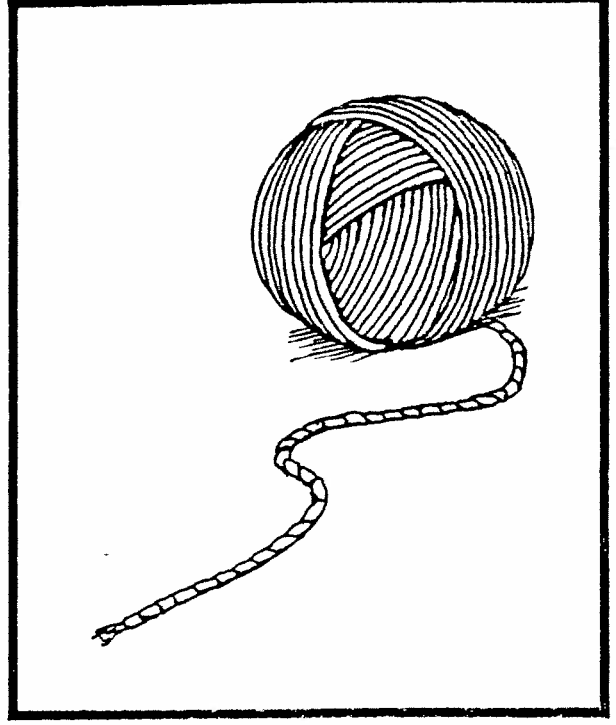

3

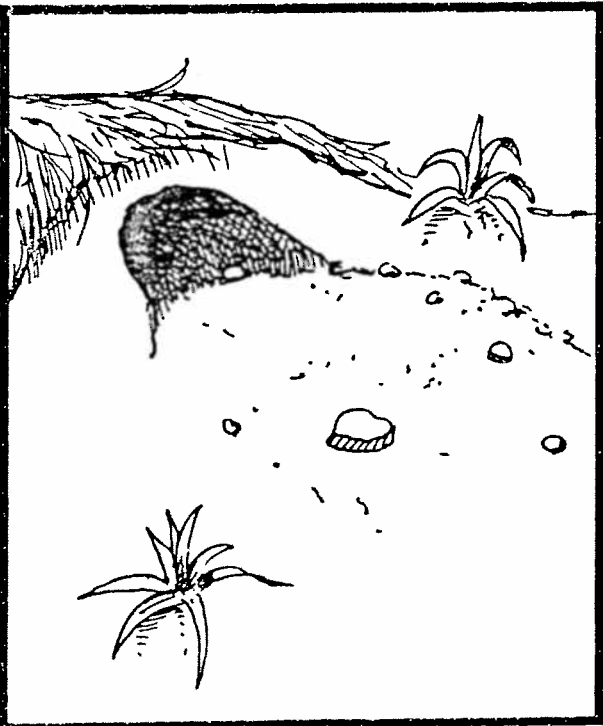

4

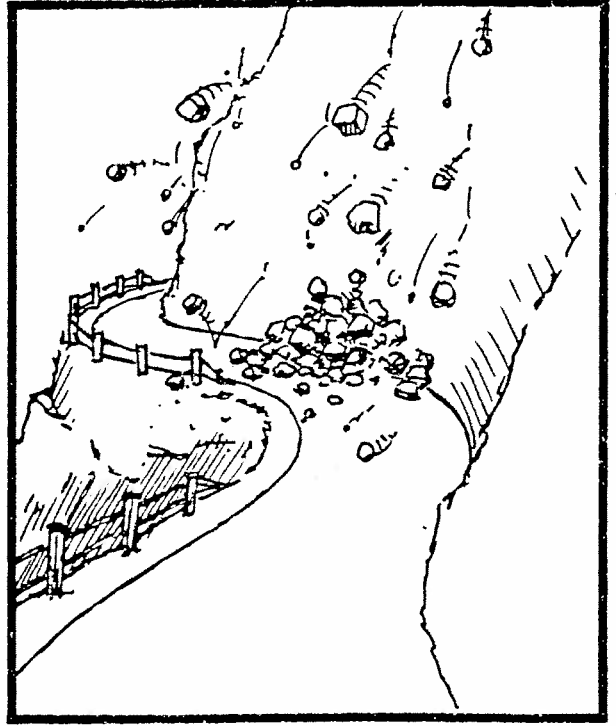

ponte

1



2



3

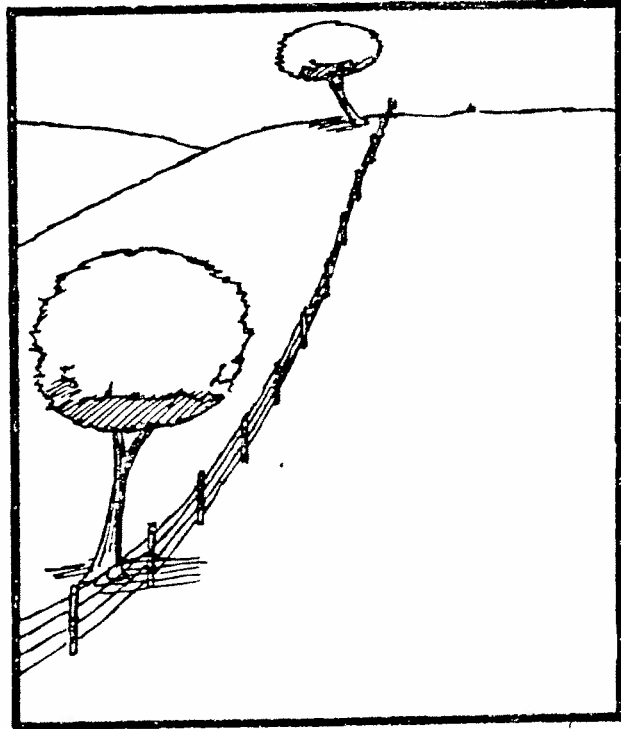

4



pappa

1



2

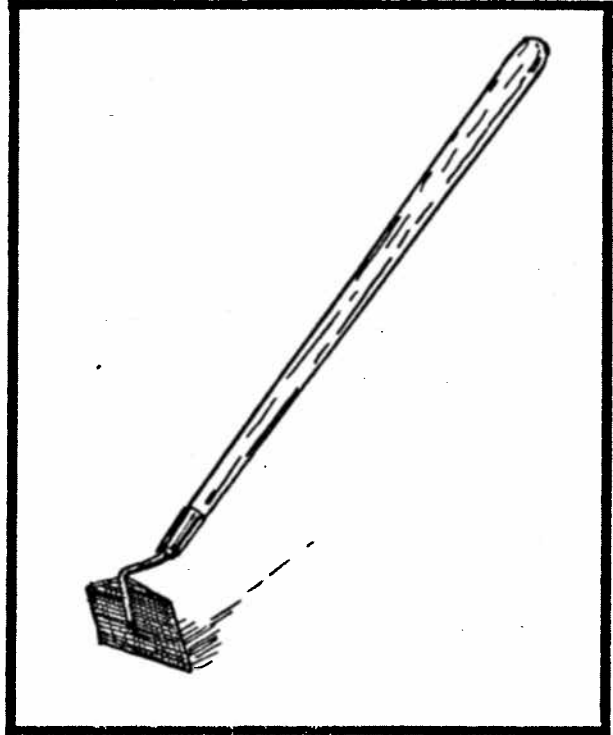

3

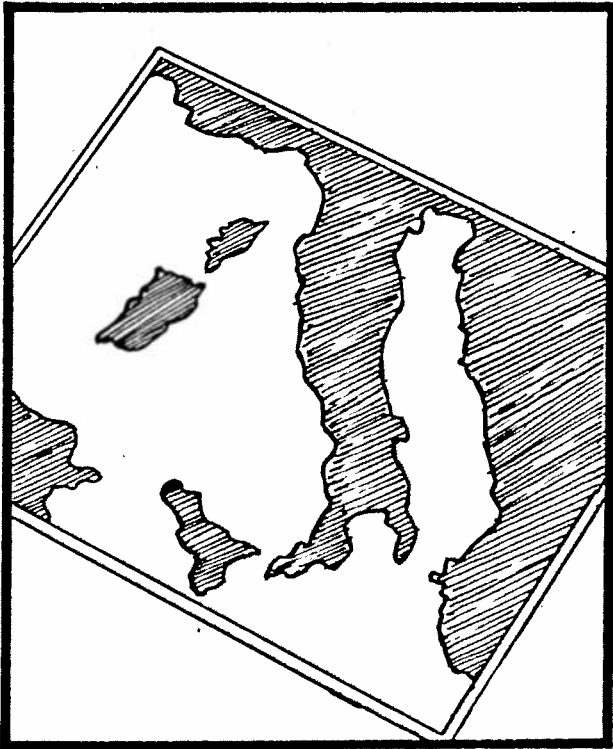

4



tacco

1

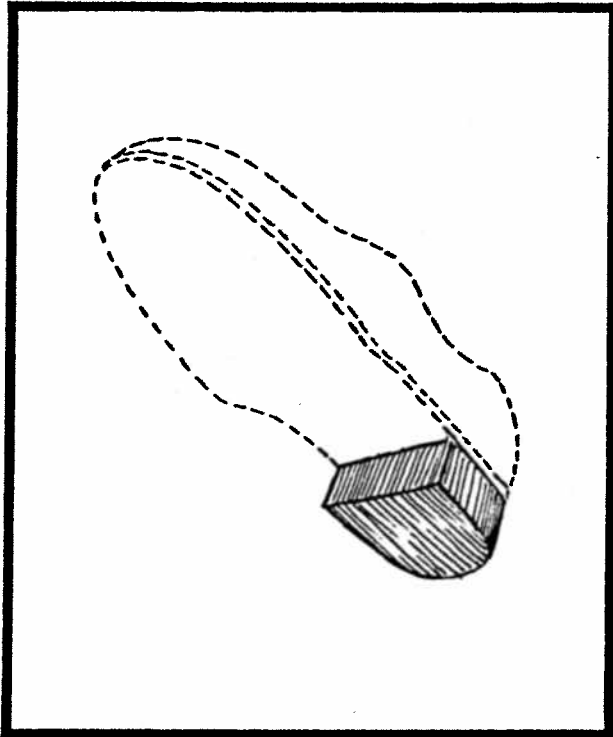

2

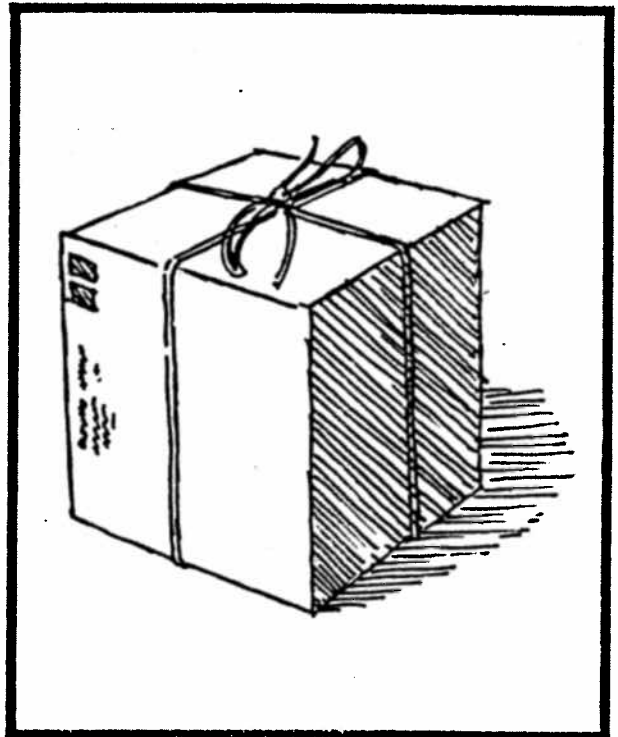

3

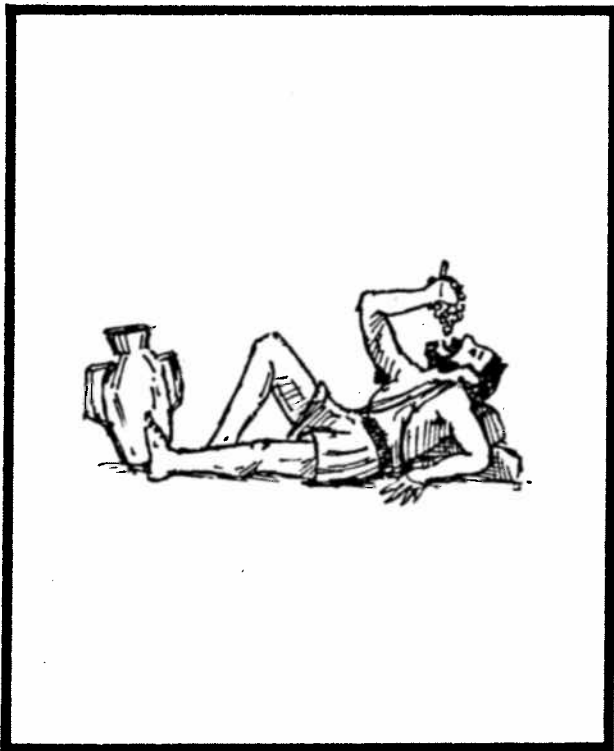

4

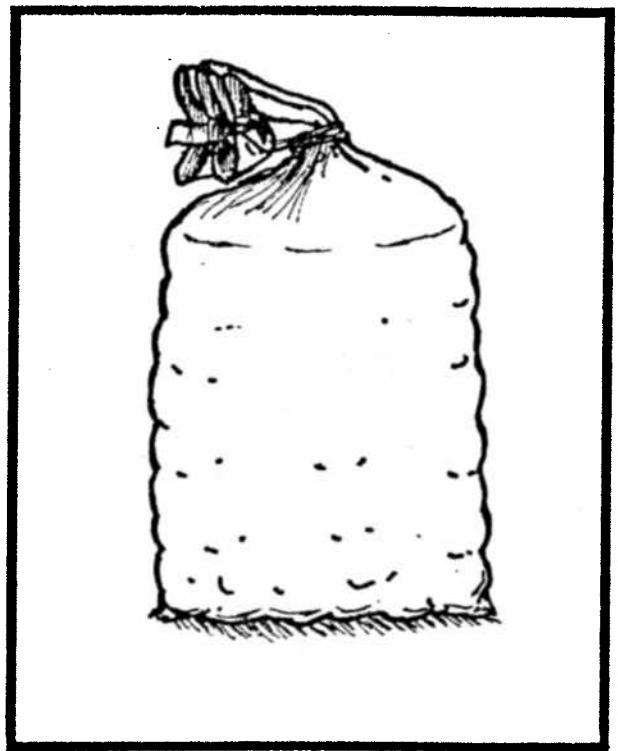

stalla

1

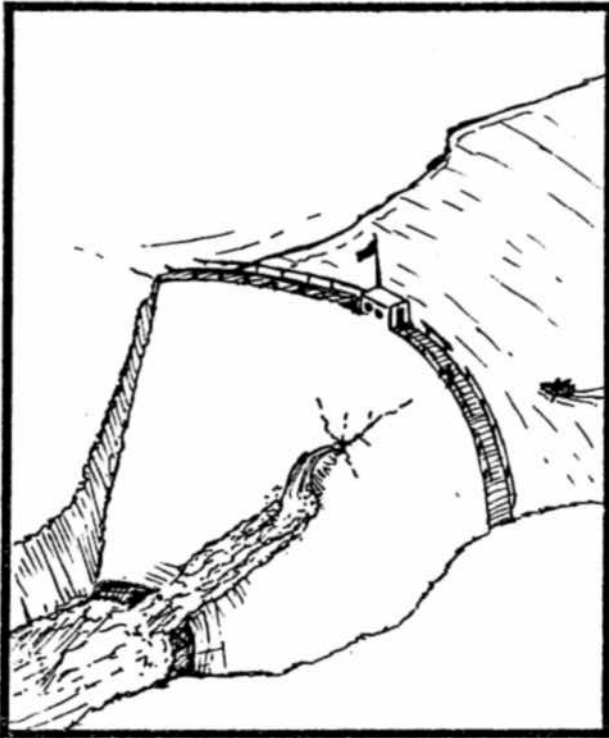

2

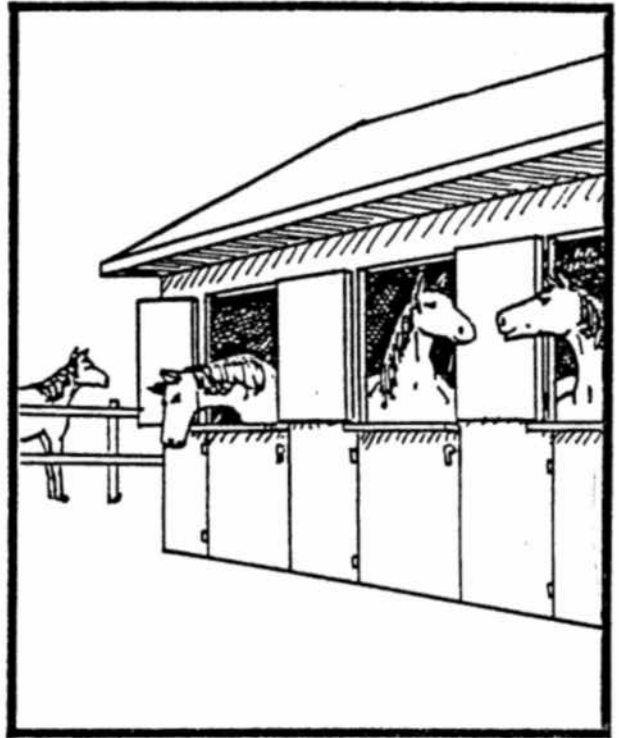

3

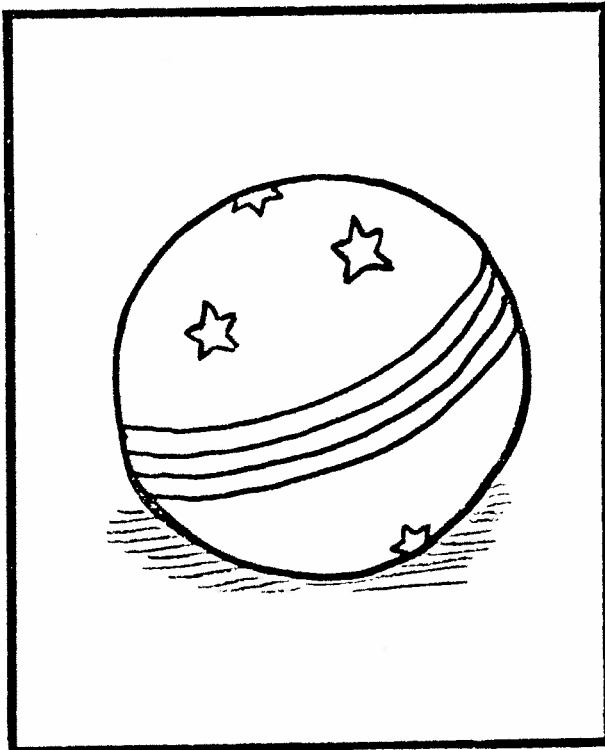

4

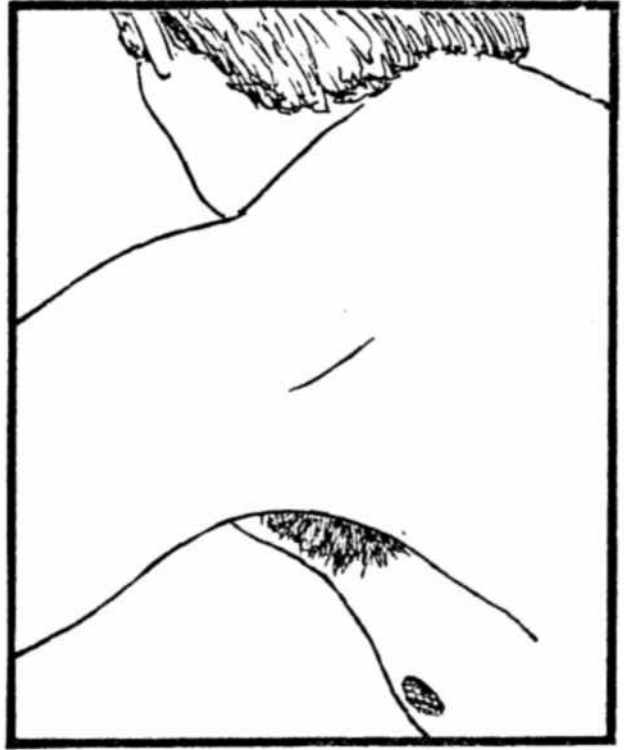

COMPRESIONE DI TESTO SCRITTO (FRASI)

Il ragazzo tiene la ragazza.

1

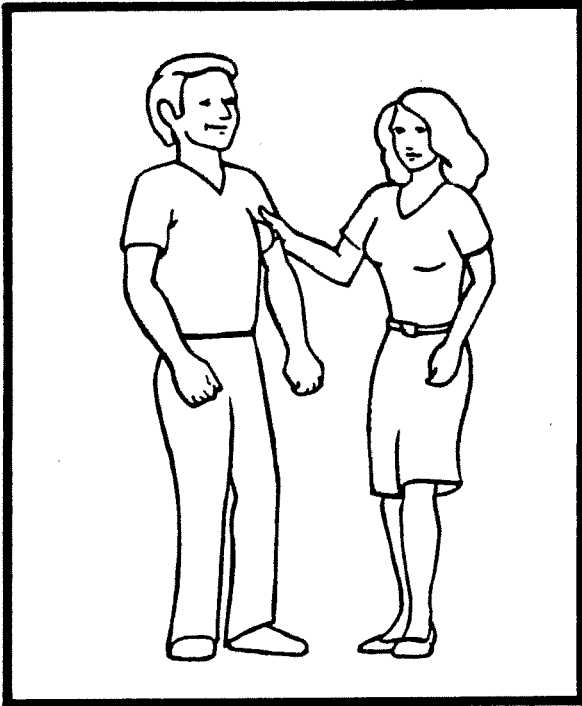

2

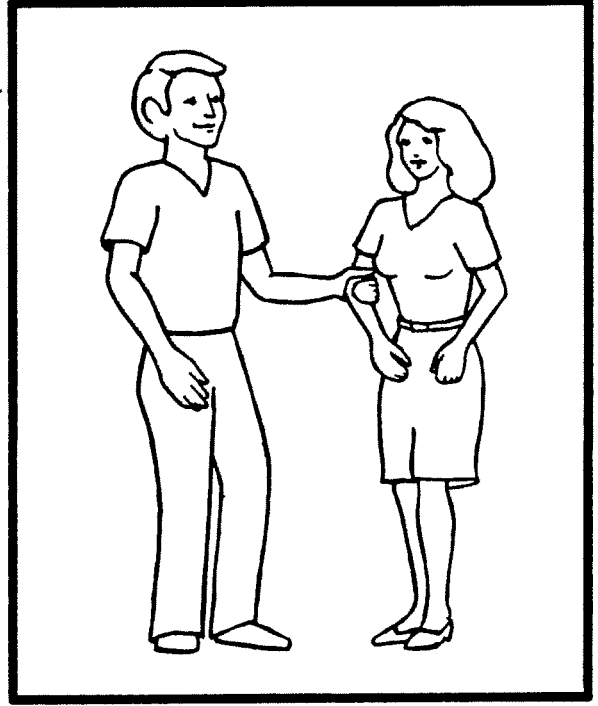

3

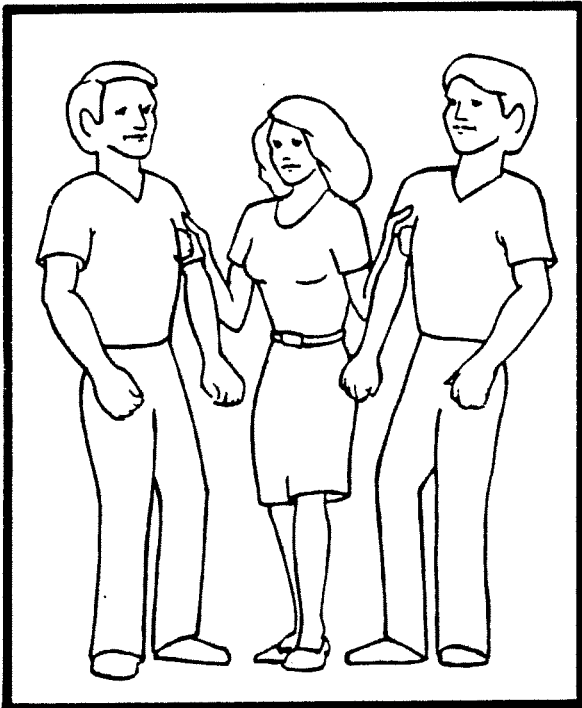

4

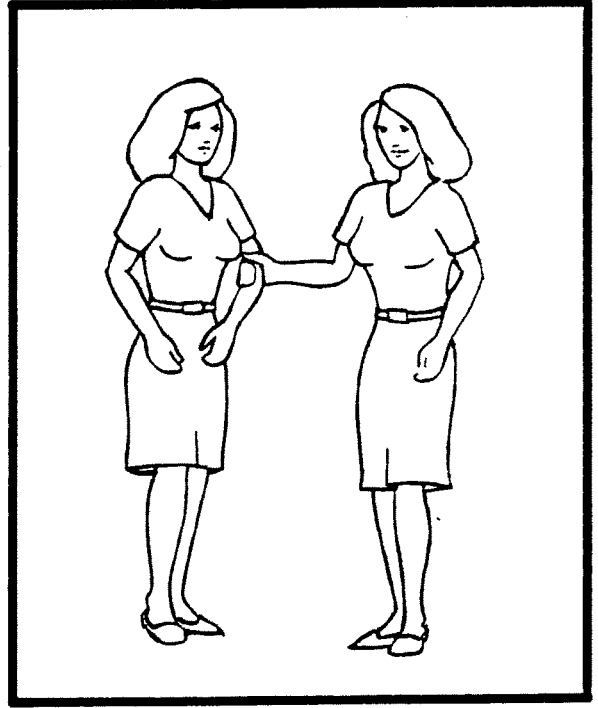

Lei lo spinge.

1

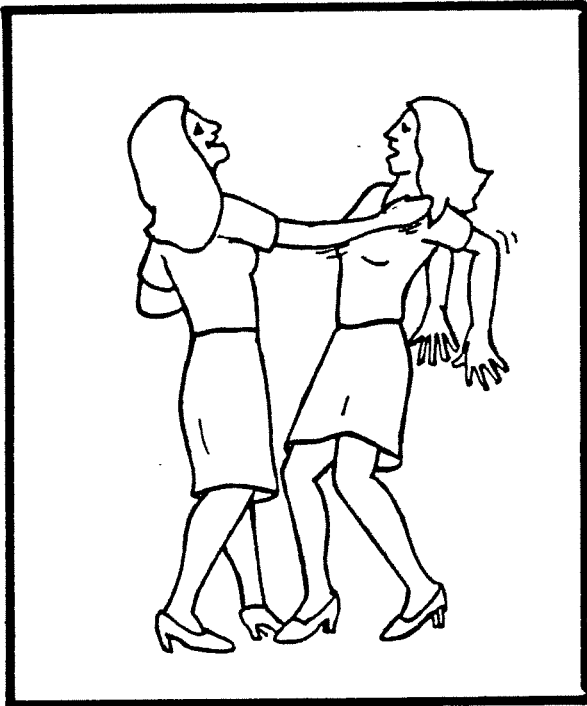

2

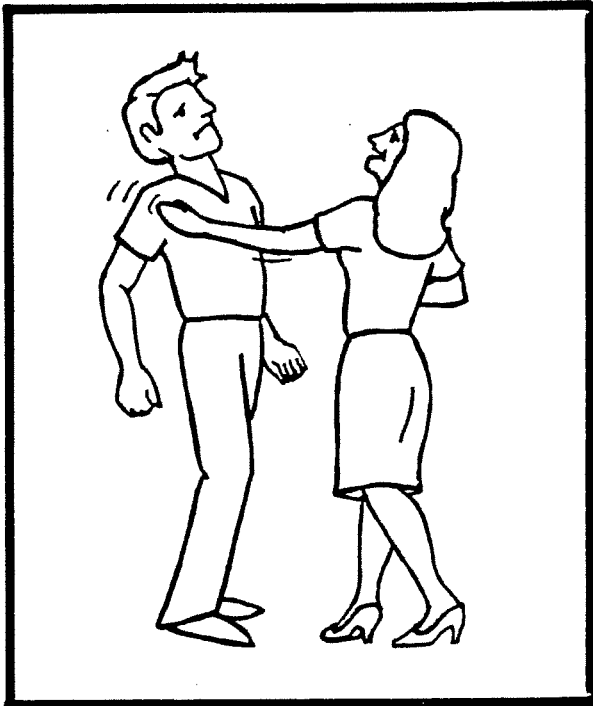

3

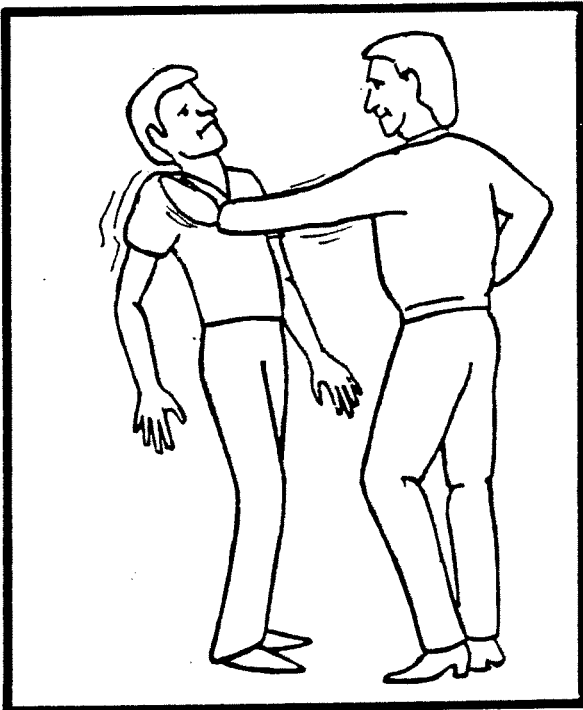

4

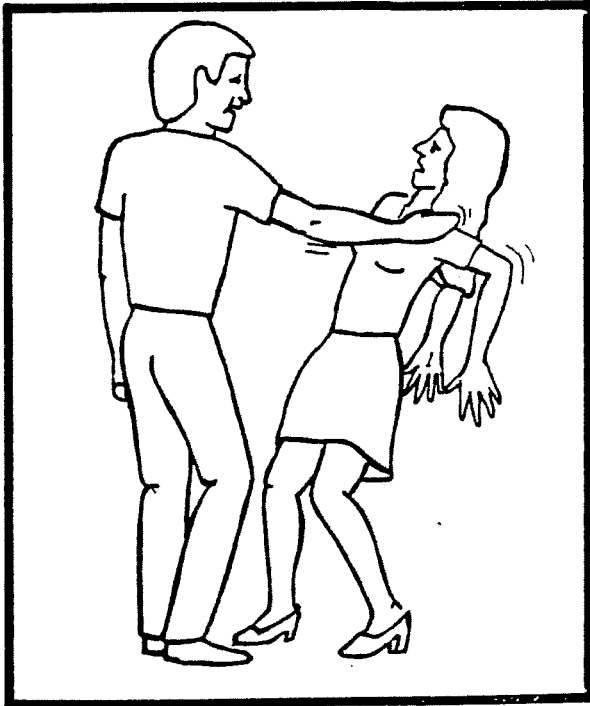

Il cane é morso dal gatto.

1

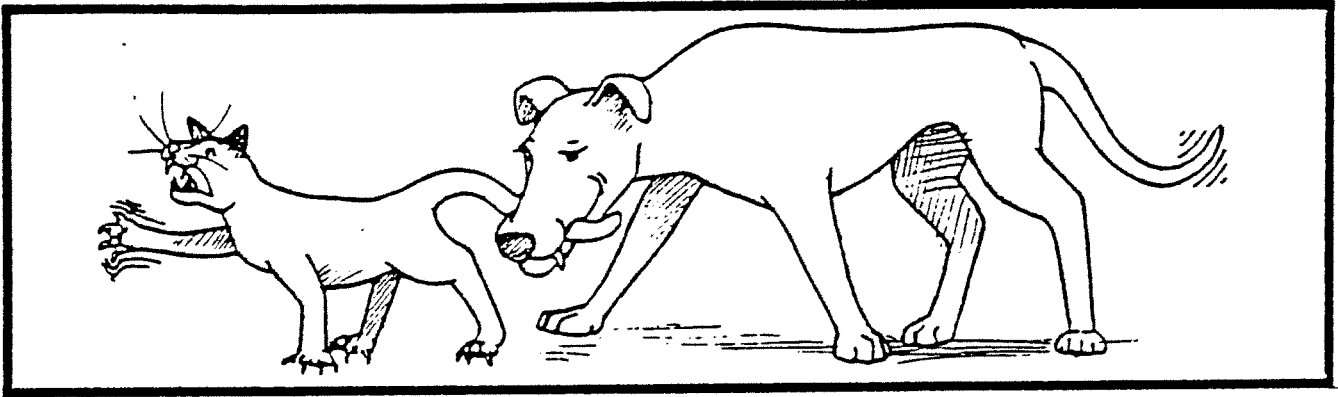

2

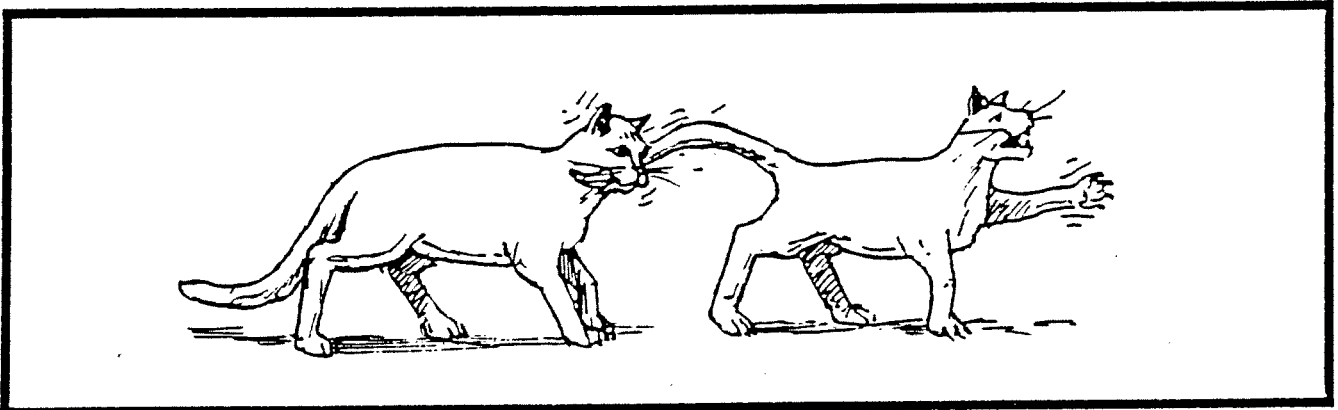

3

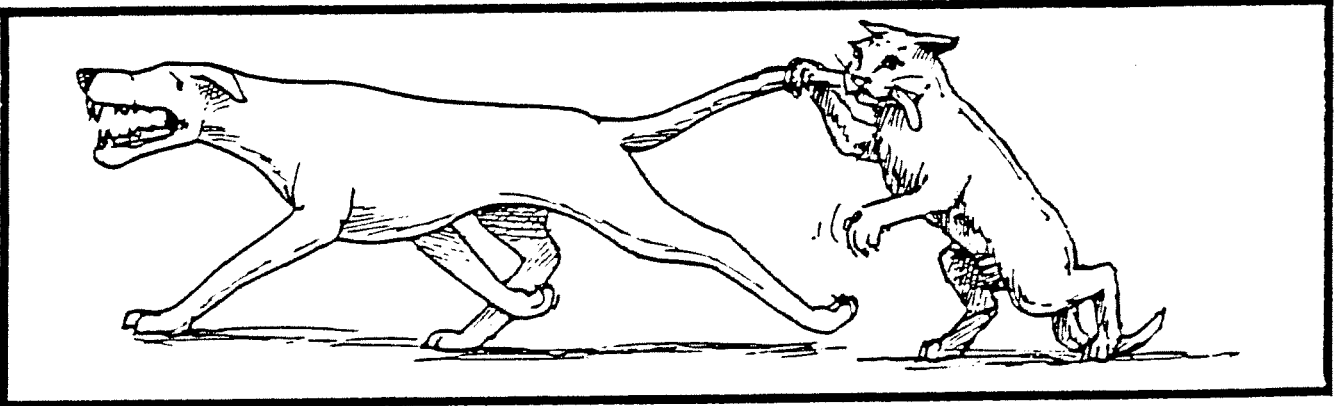

4

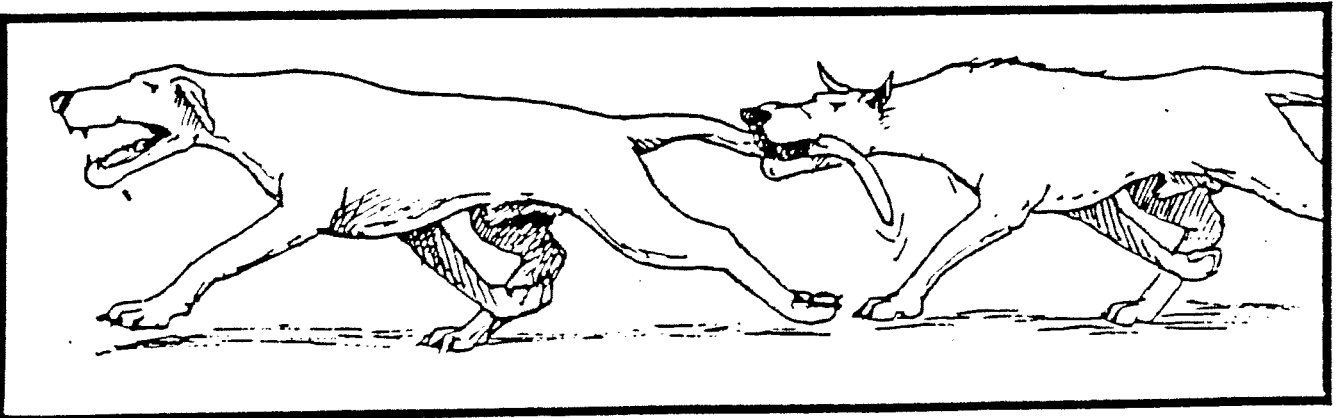

È il camion che tira la macchina.

1

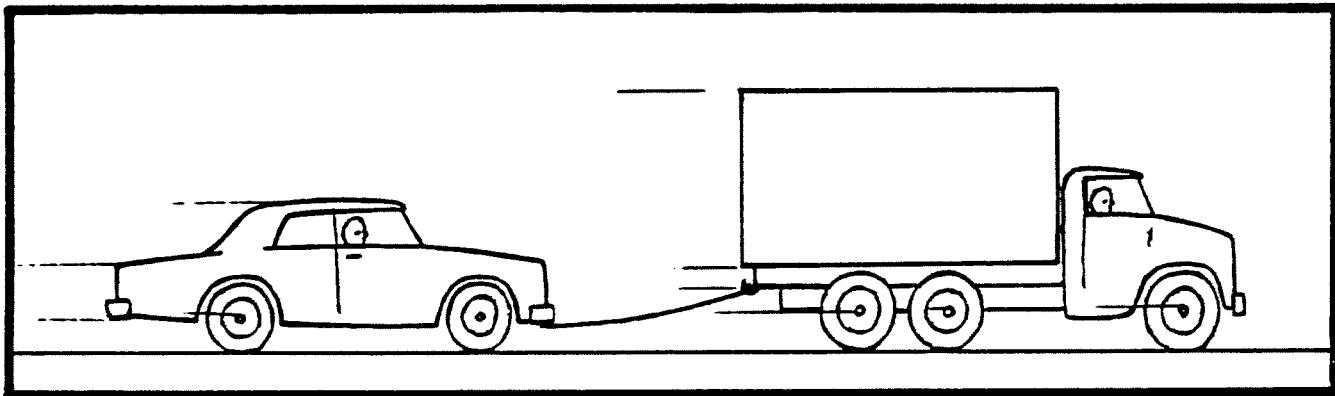

2

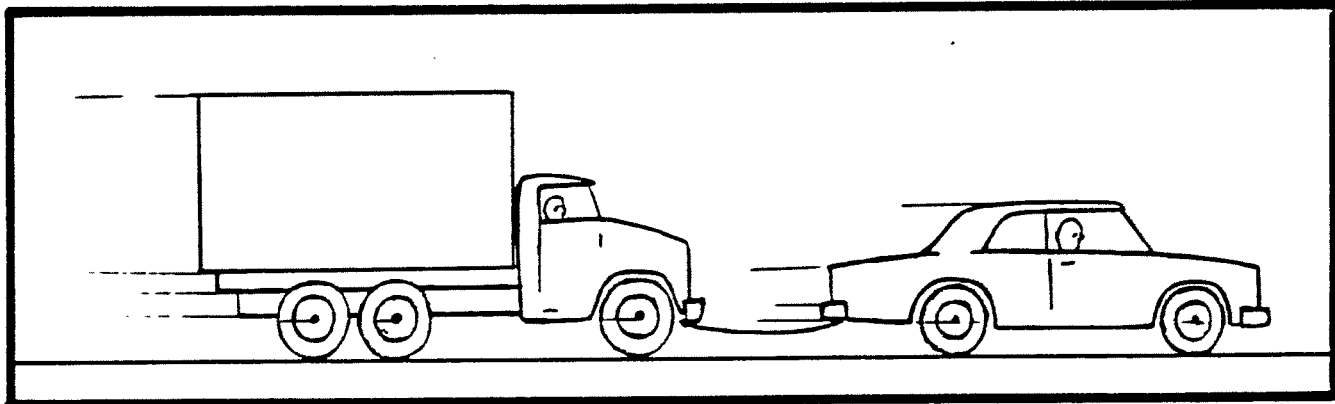

Il ragazzo non spinge la ragazza.

1

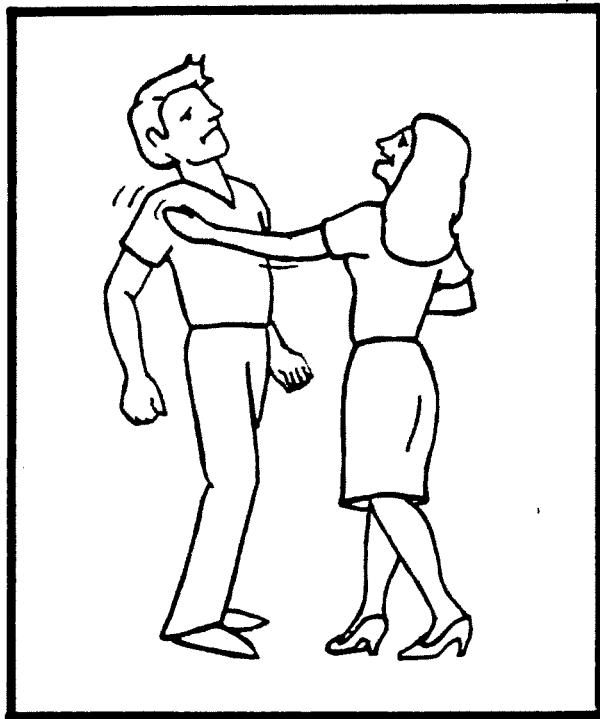

2

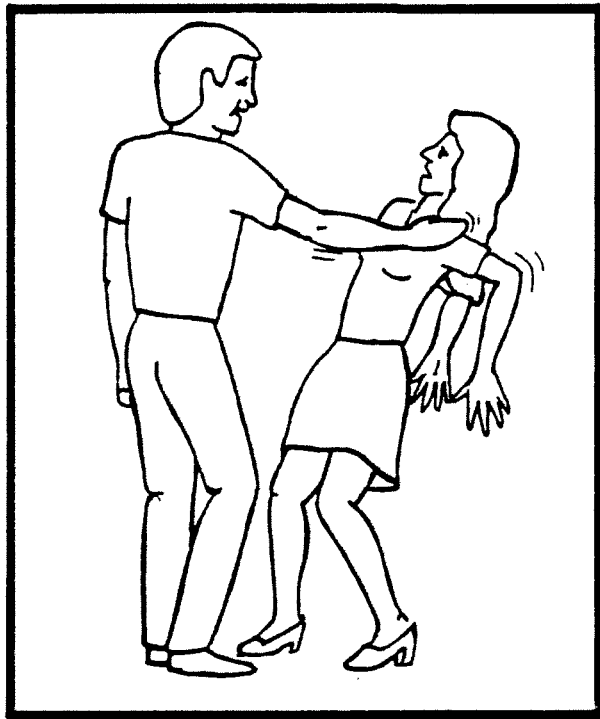

Il camion non é tirato dalla macchina.

1

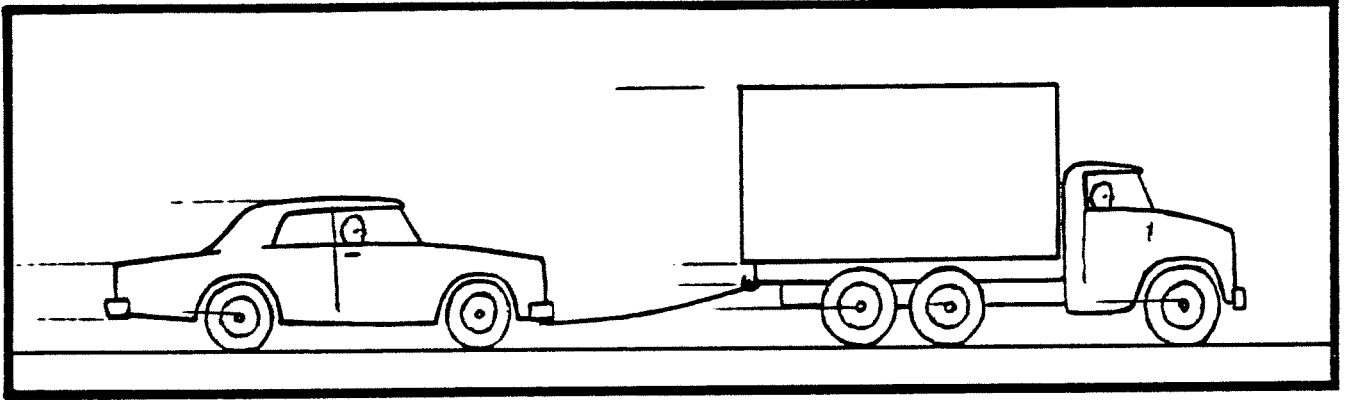

2

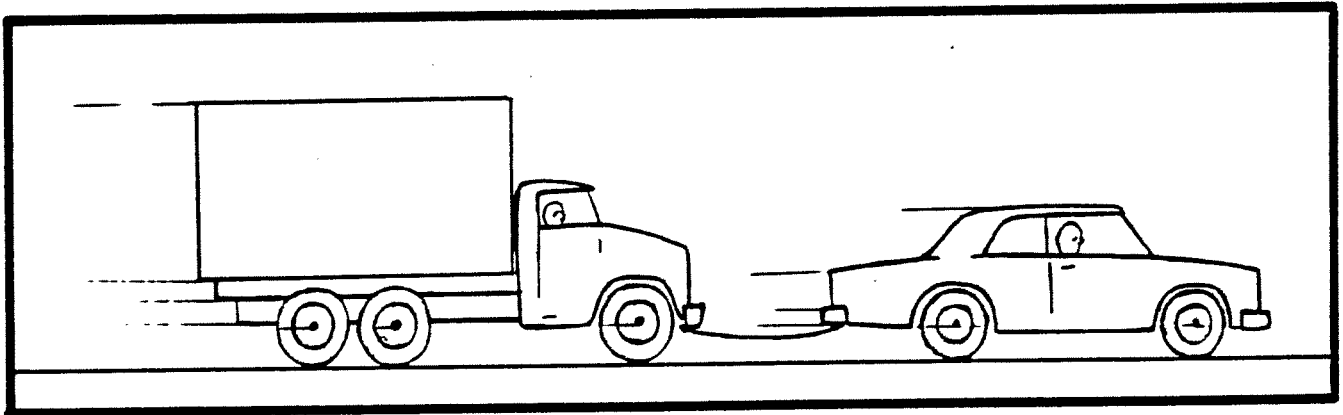

È il cane che il gatto morde.

1

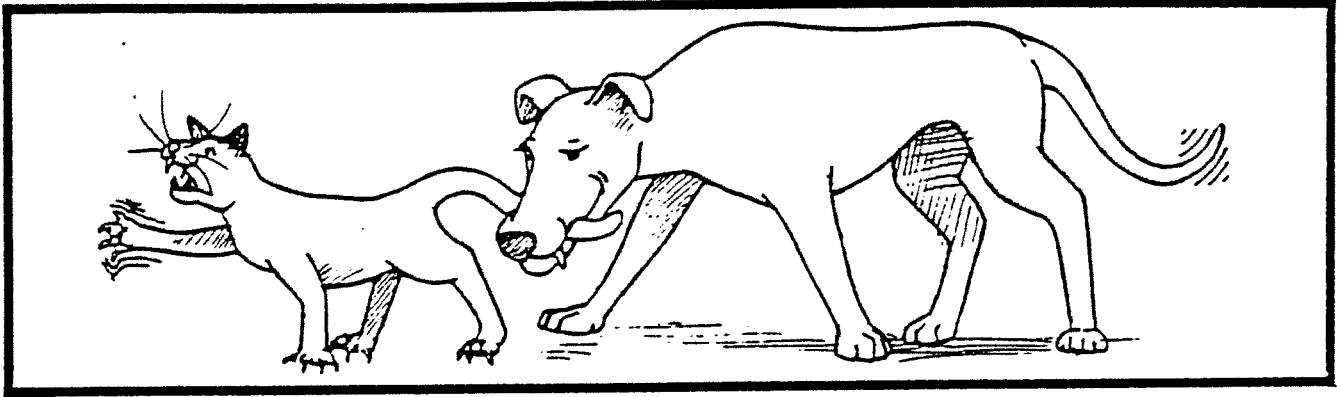

2

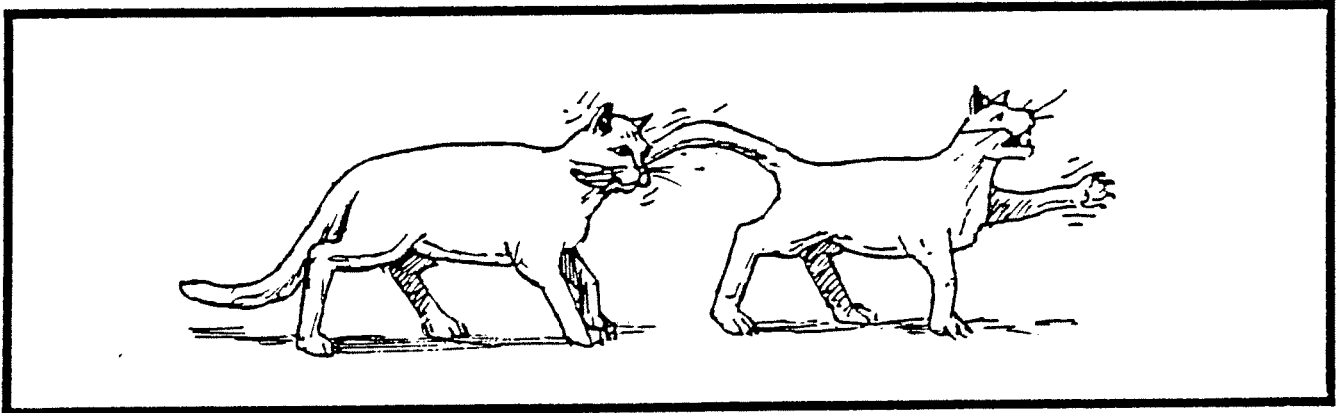

3

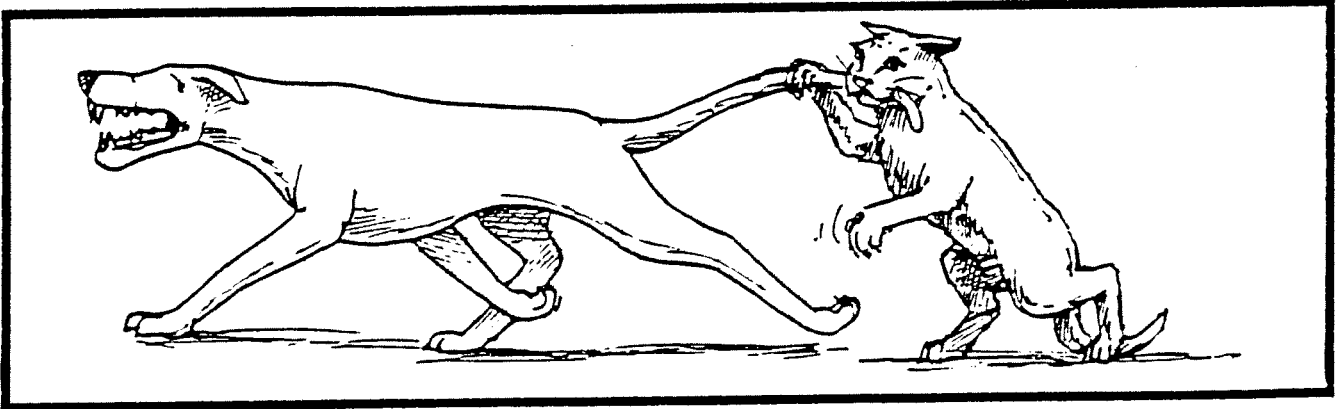

4

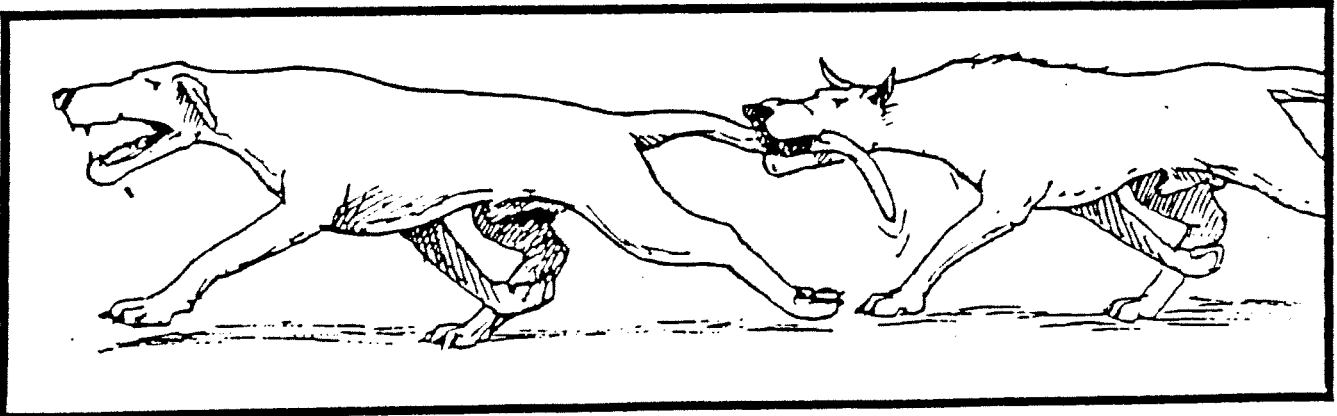

Lui la tiene.

1

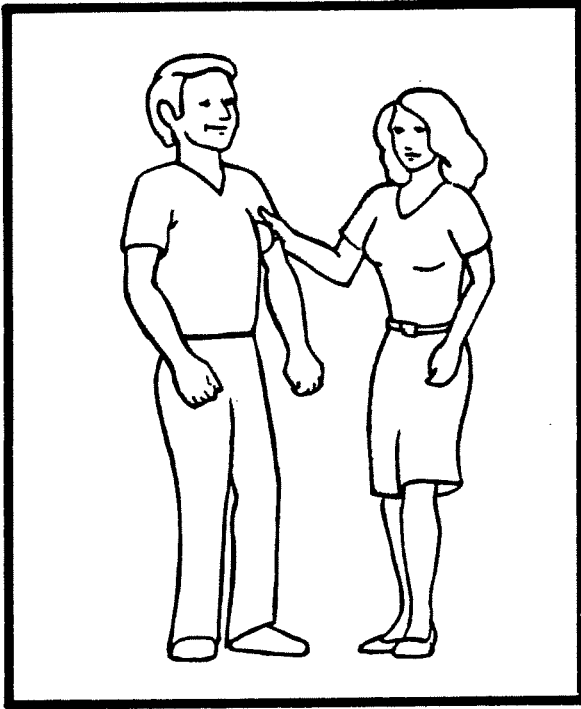

2

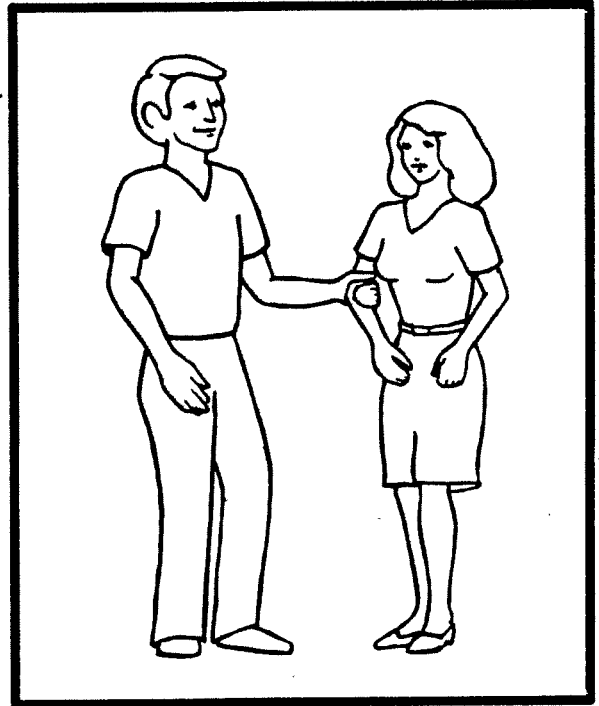

3

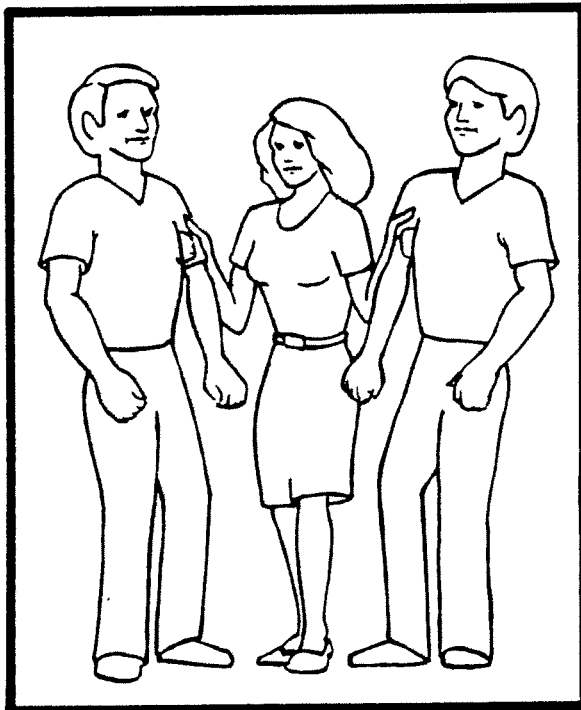

4

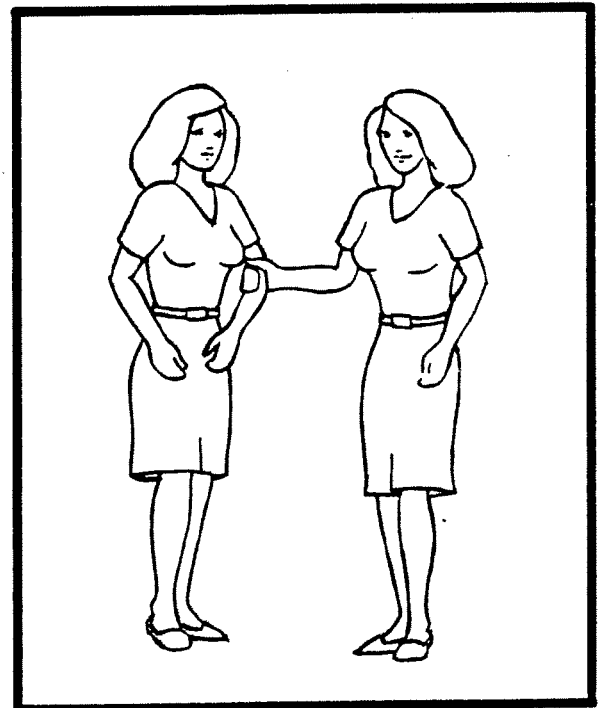

La ragazza é spinta dal ragazzo.

1

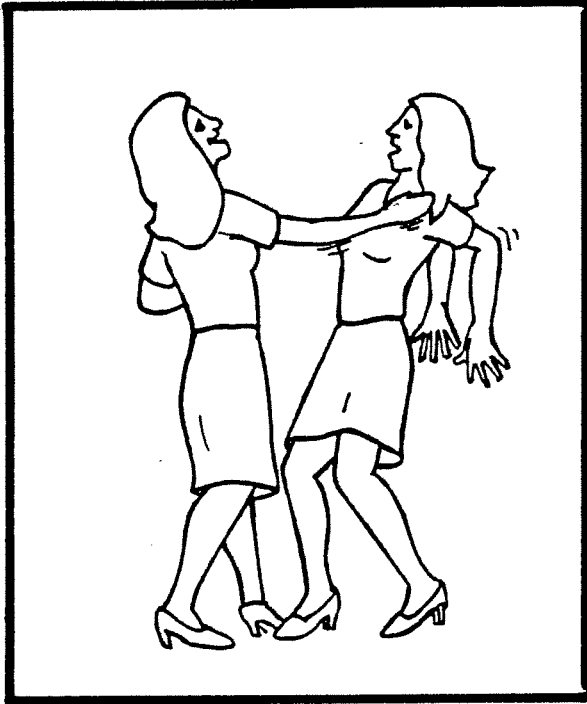

2

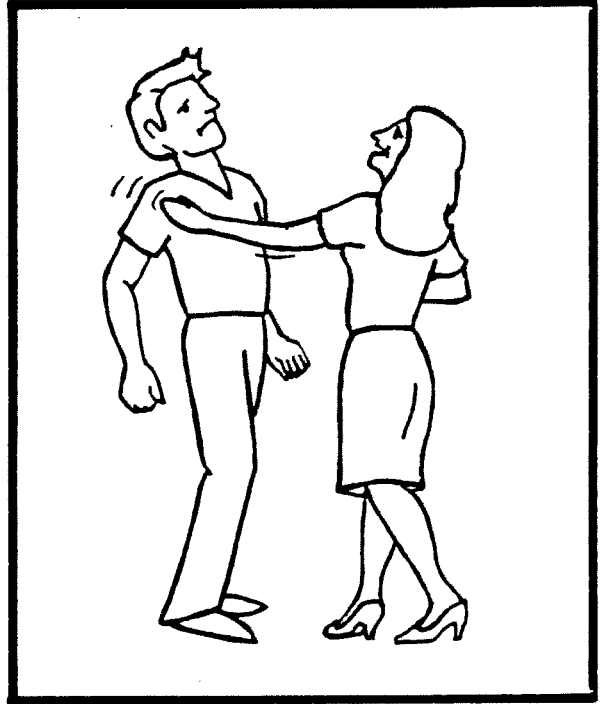

3

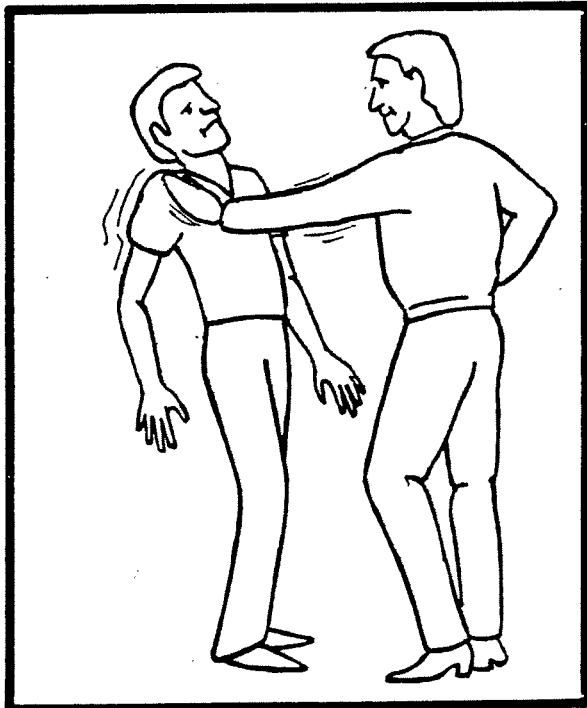

4

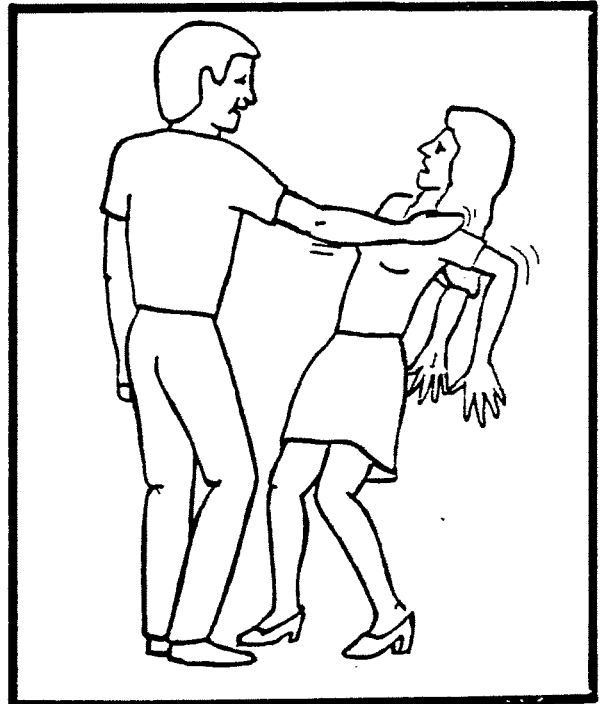

La ragazza non é bagnata dal ragazzo.

1

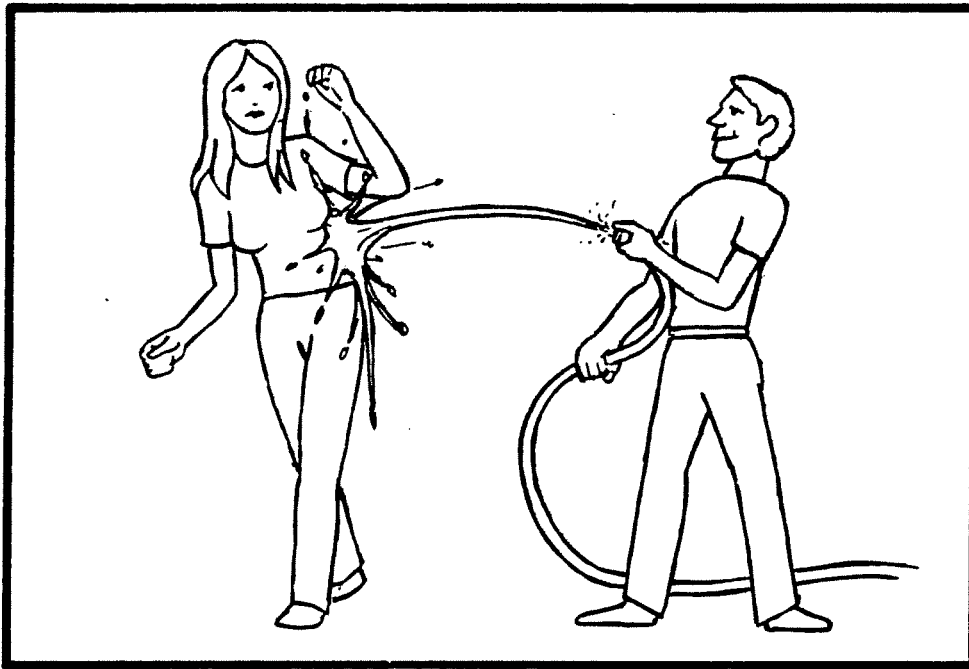

2

