

Michel Paradis  
McGill University

# BILINGUAL APHASIA TEST

(HUNGARIAN VERSION)

## STIMULUS BOOK

MAGYAR

The development of the Bilingual Aphasia Test materials was supported by Grant MEQ 01-07-k (1976-1983) from the Quebec Ministry of Intergovernmental Affairs, Grant EQ 1660 (1980-1985) from the Quebec Ministry of Education FCAC Fund, and Grants 410-83-1028 (1984, 1985) and 410-88-0821 (1989-1991) from the Social Sciences and Humanities Research Council of Canada.

HALLÀSI MEGKÜLÖNBÖZTETÈS SZAVAKBAN

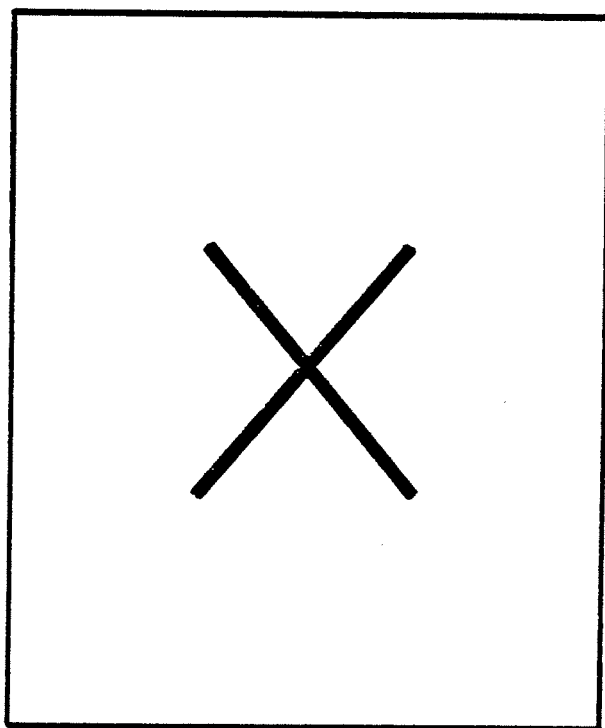

1

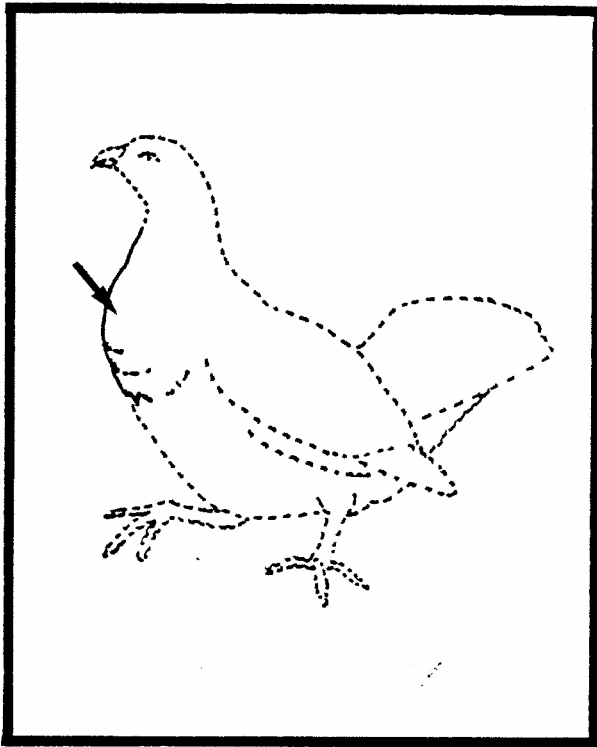

2



3

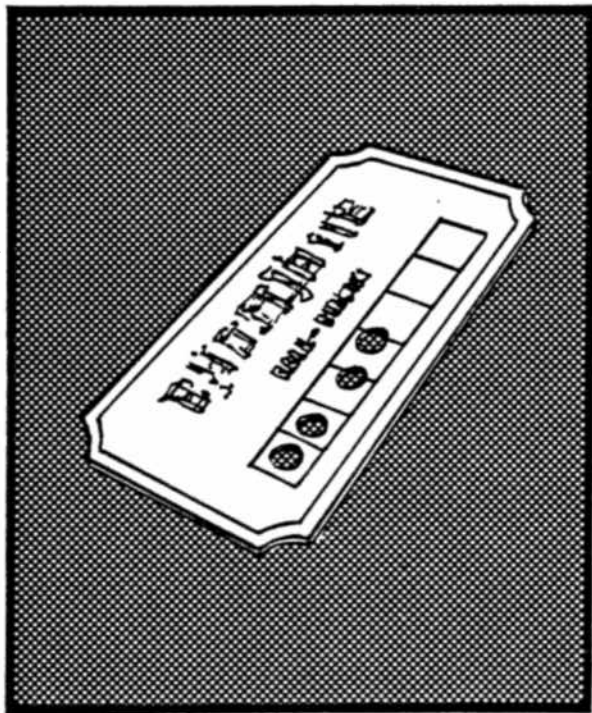

4

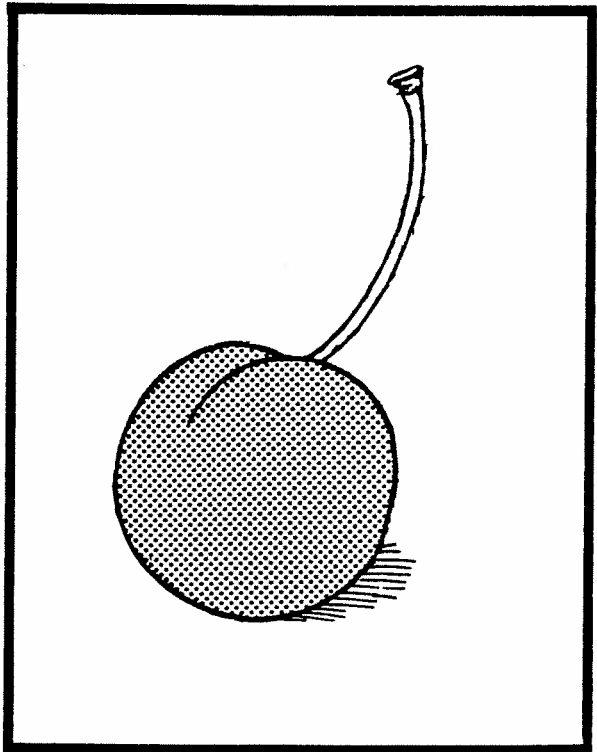

Példa

1

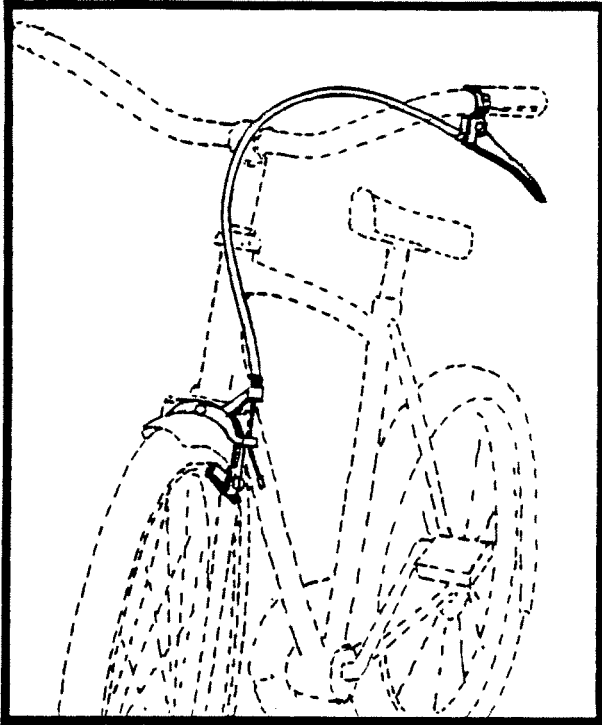

2

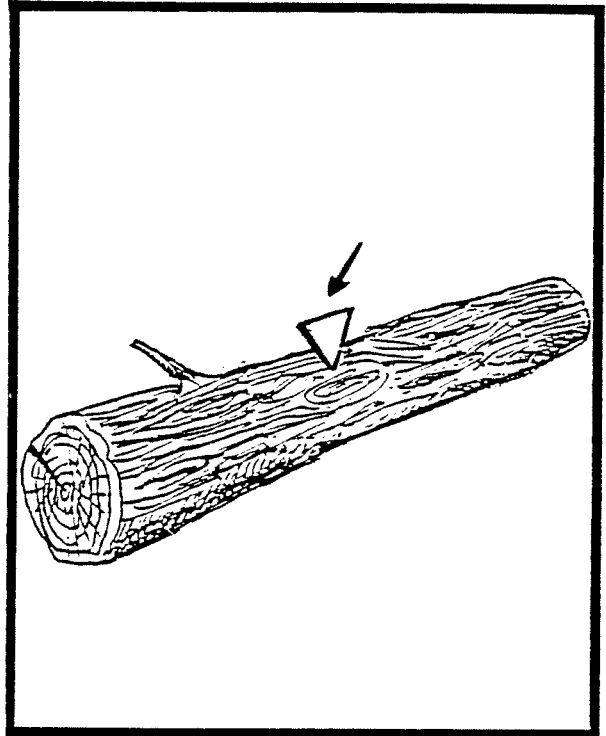

3



4

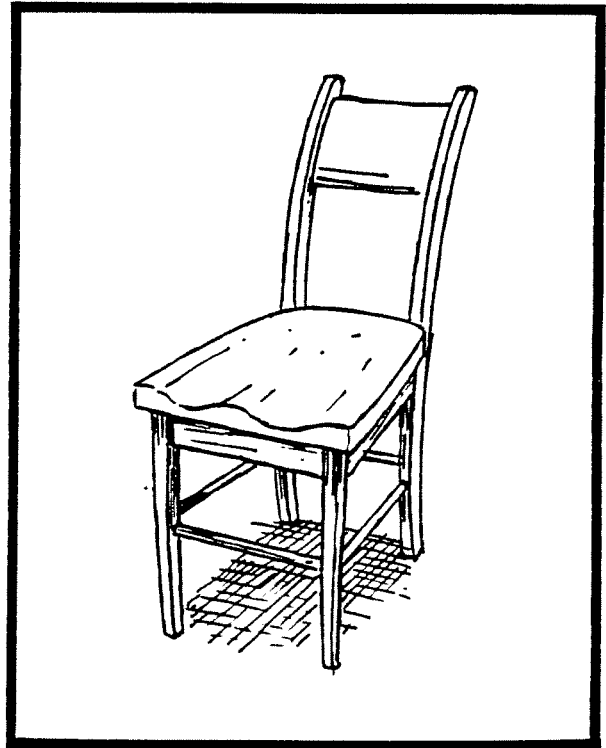

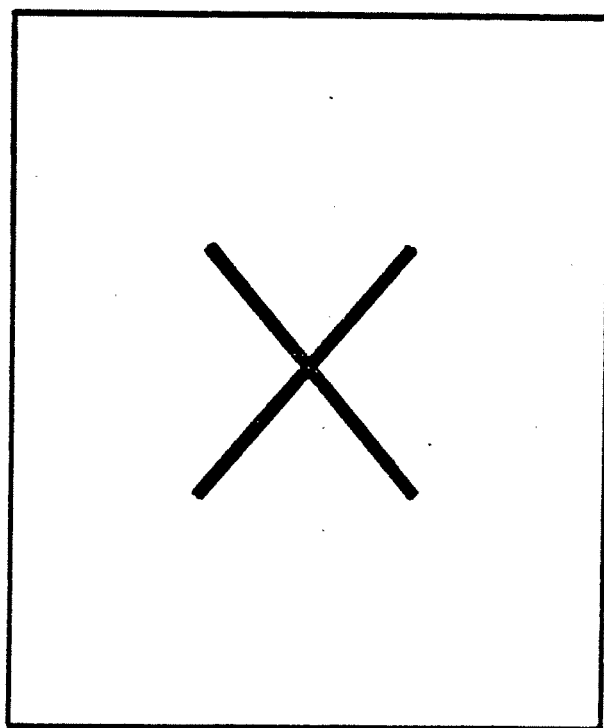

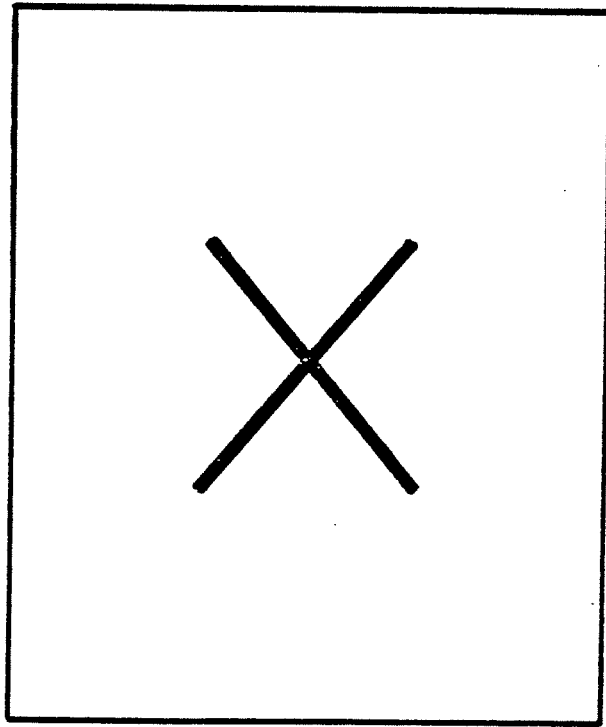



1

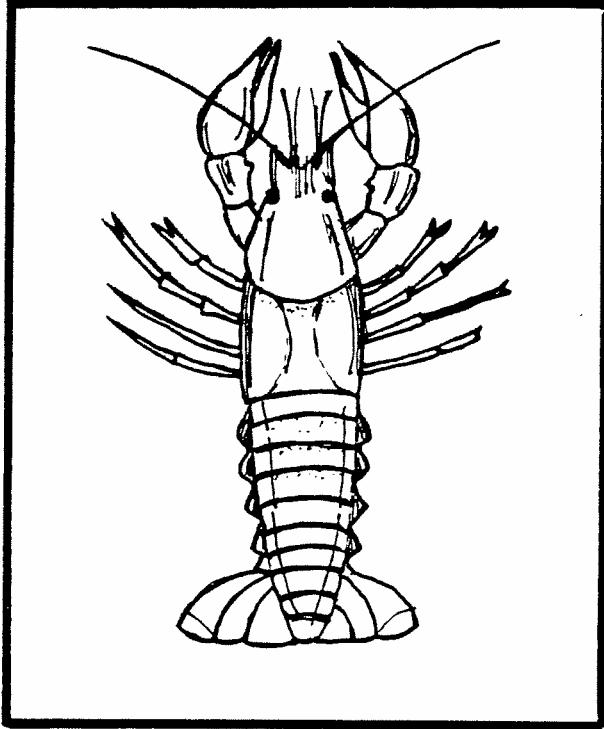

2

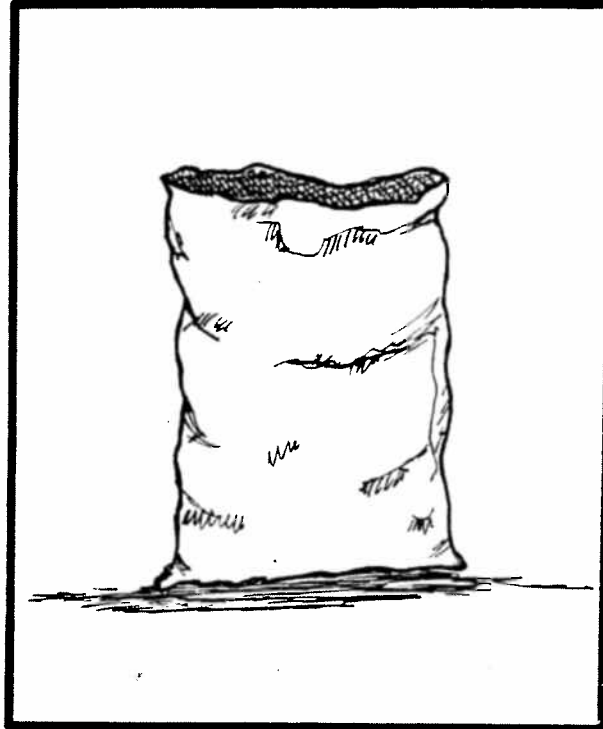

3

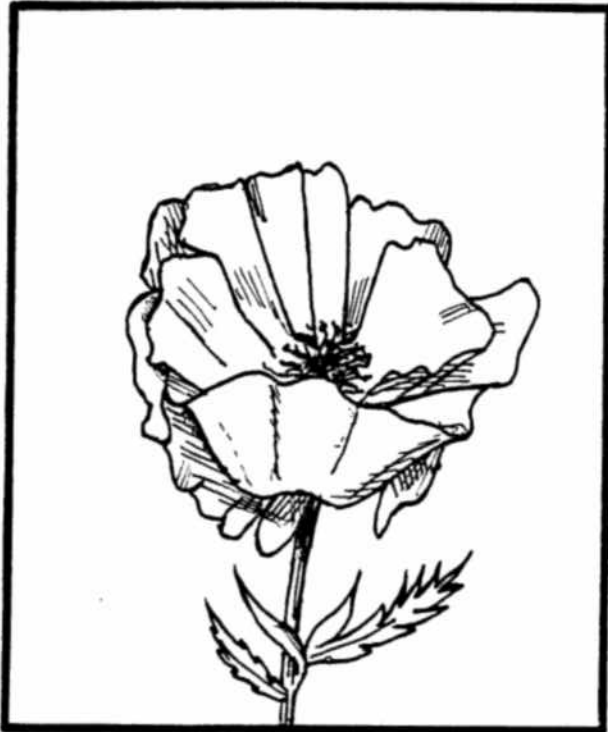

4

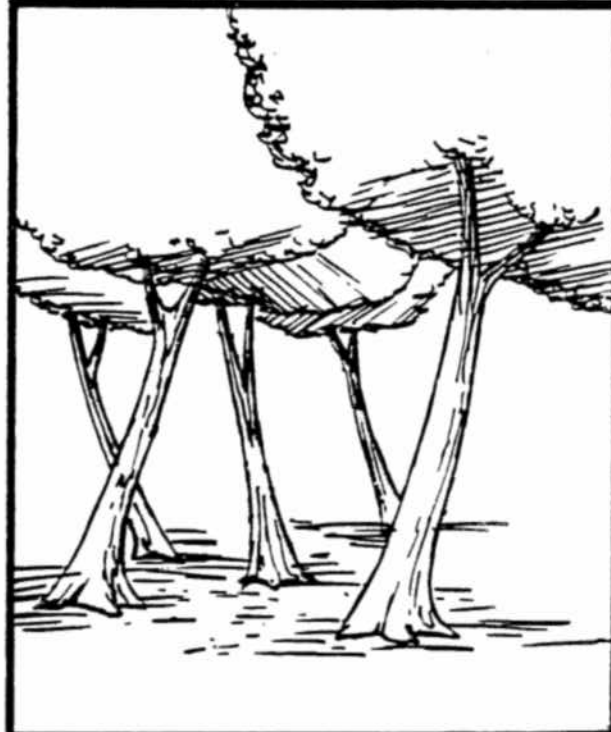

1

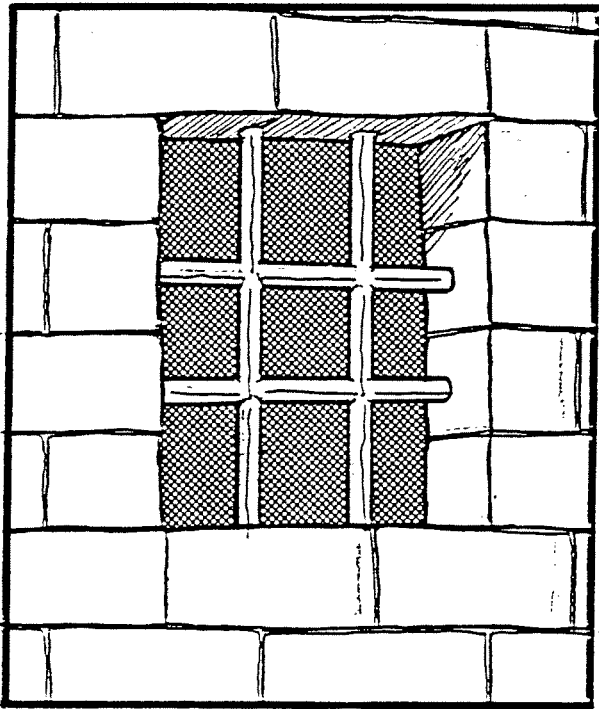

2

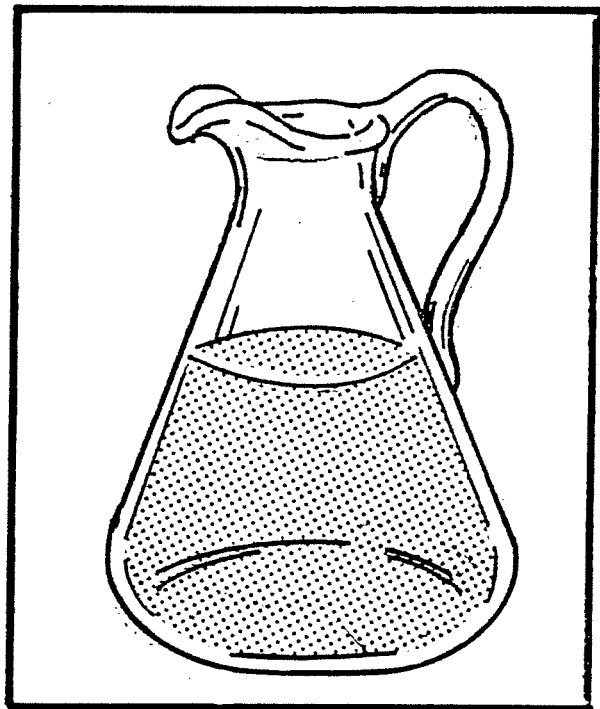

3

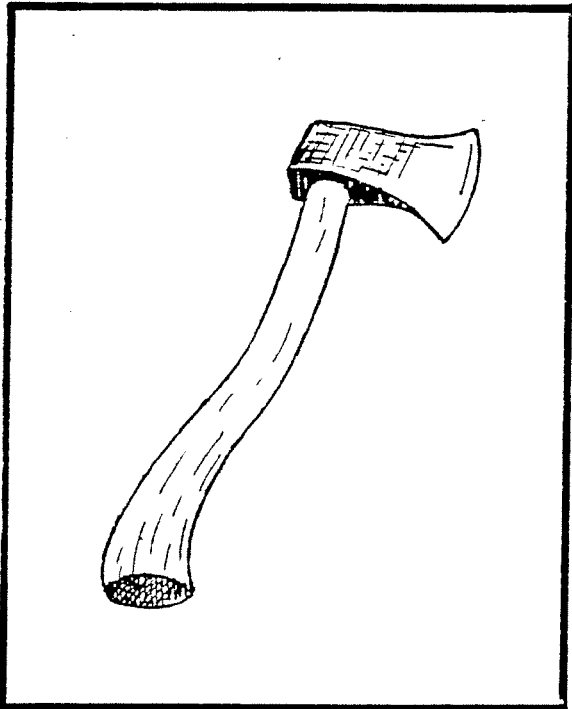

4

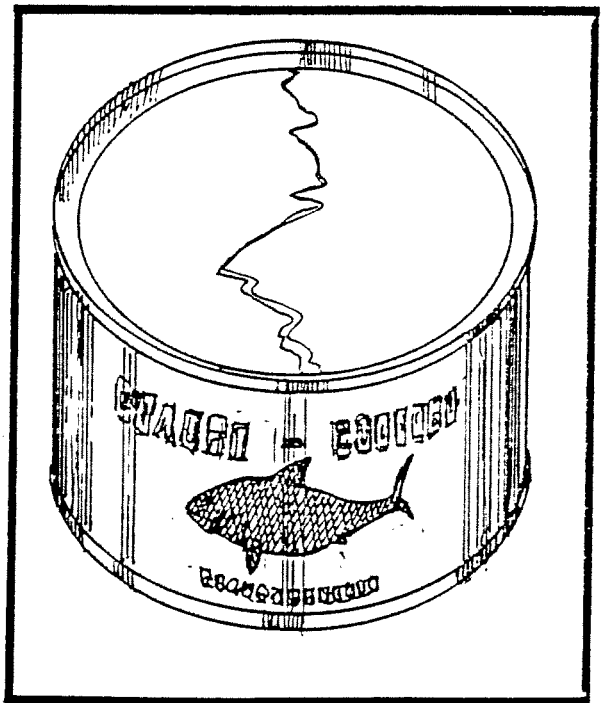

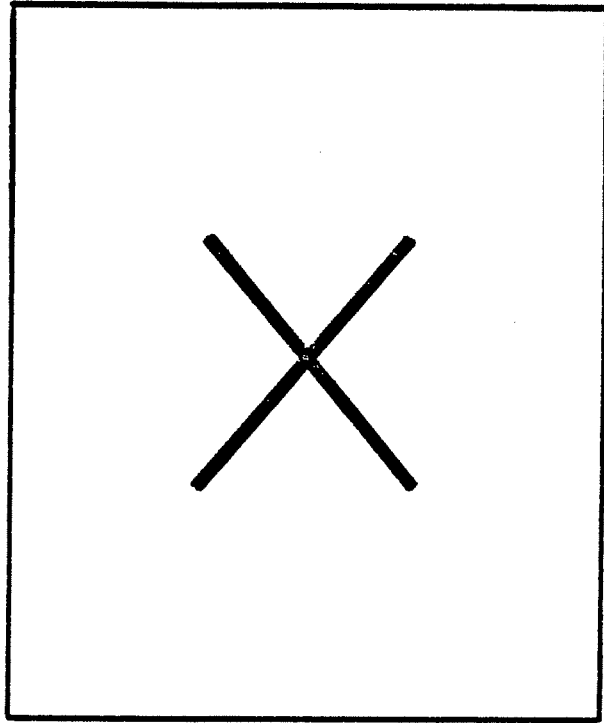

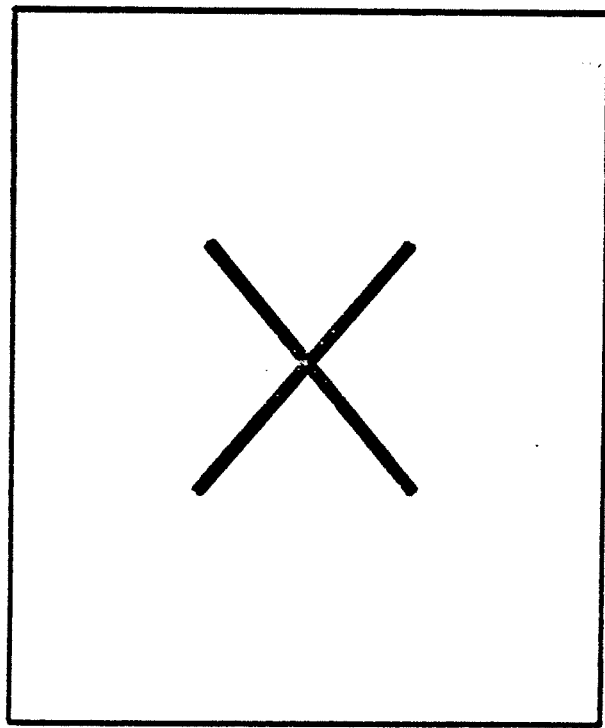

1



2

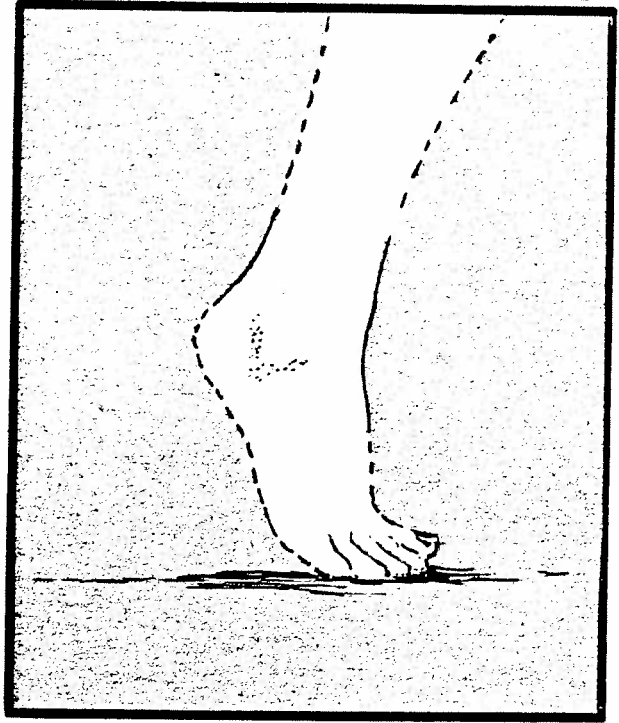

3

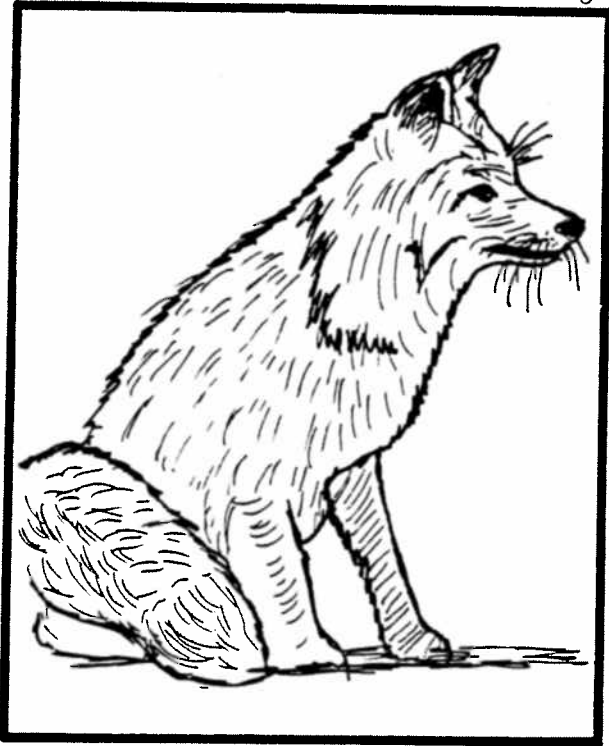

4

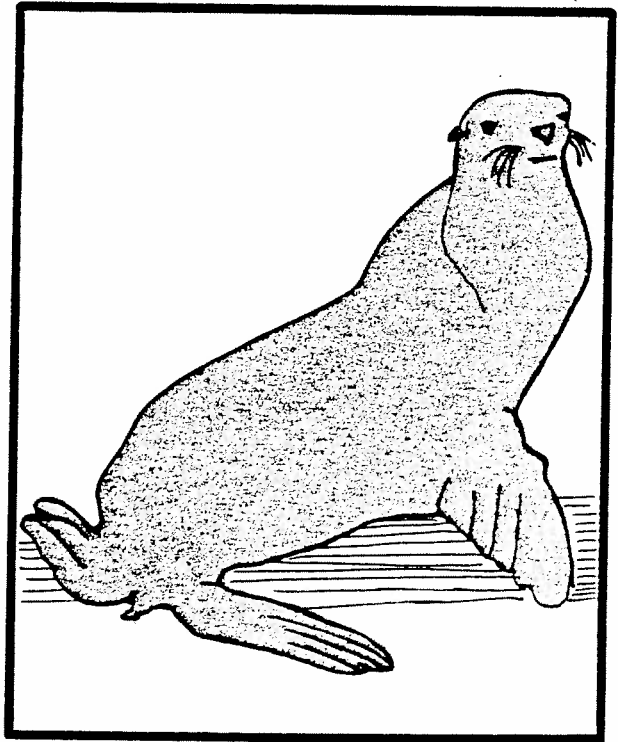

1



2

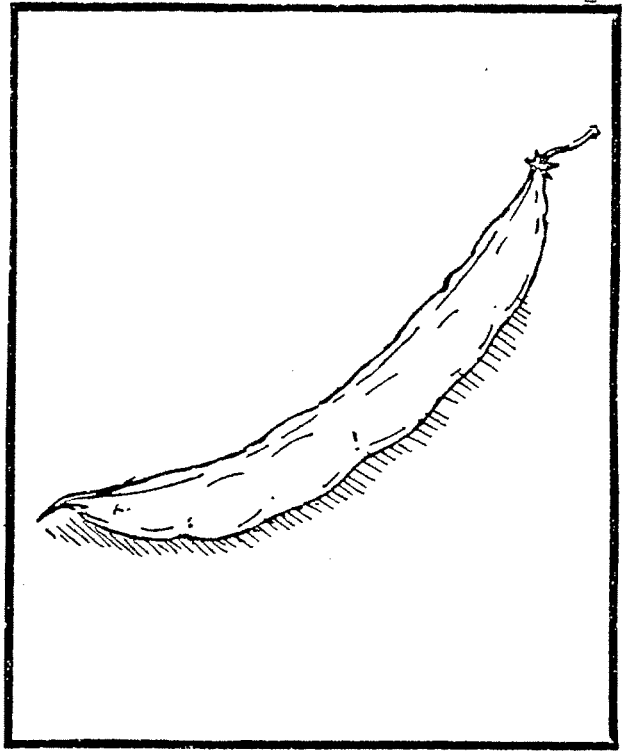

3

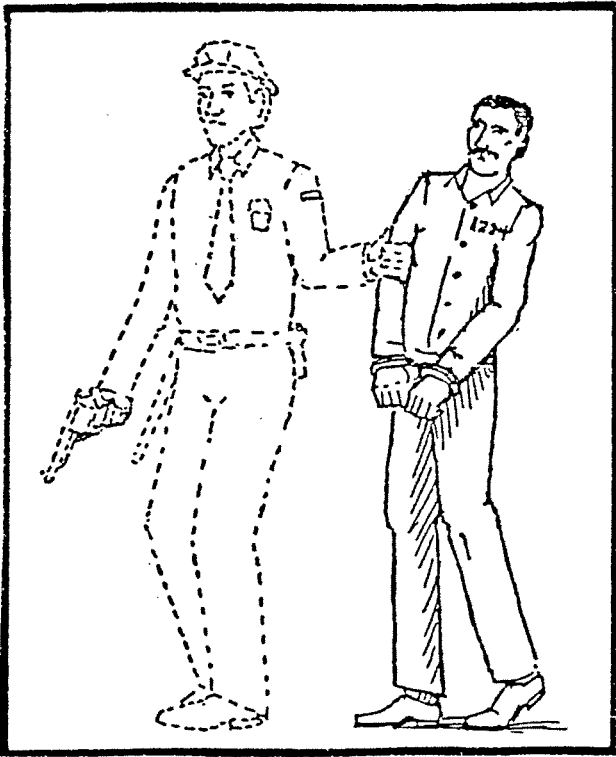

4

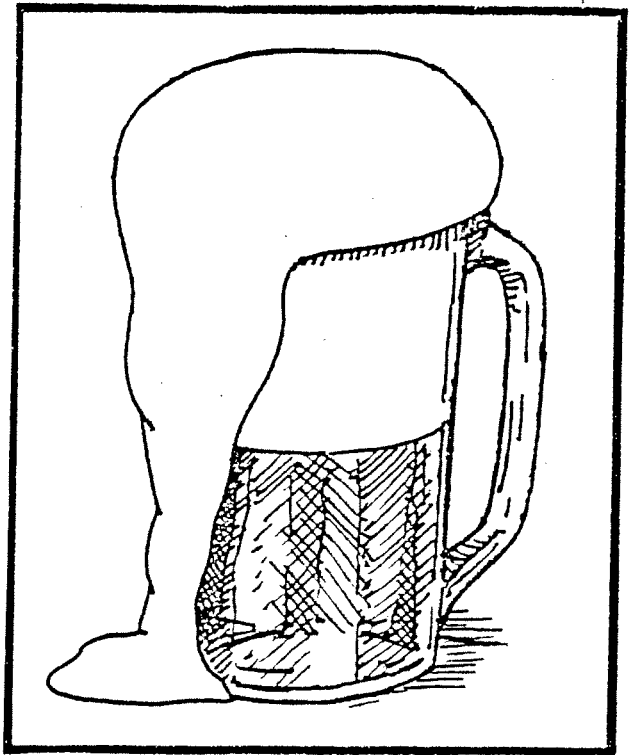

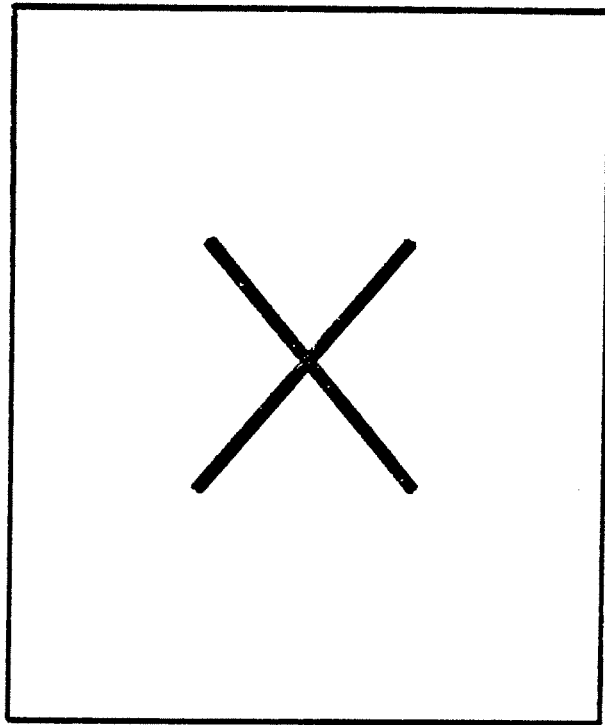

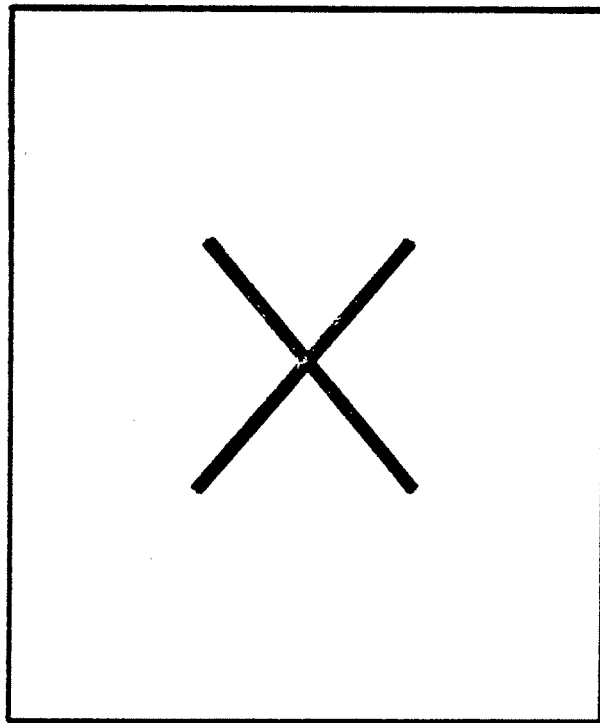



1

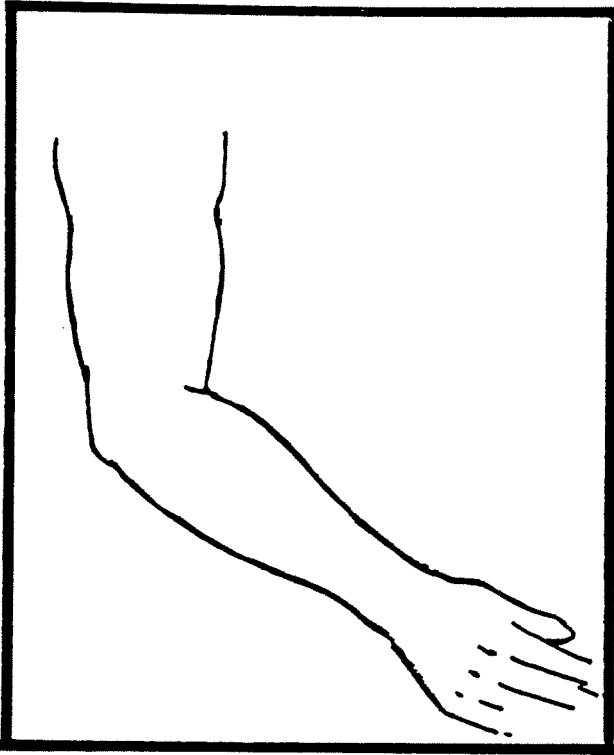

2

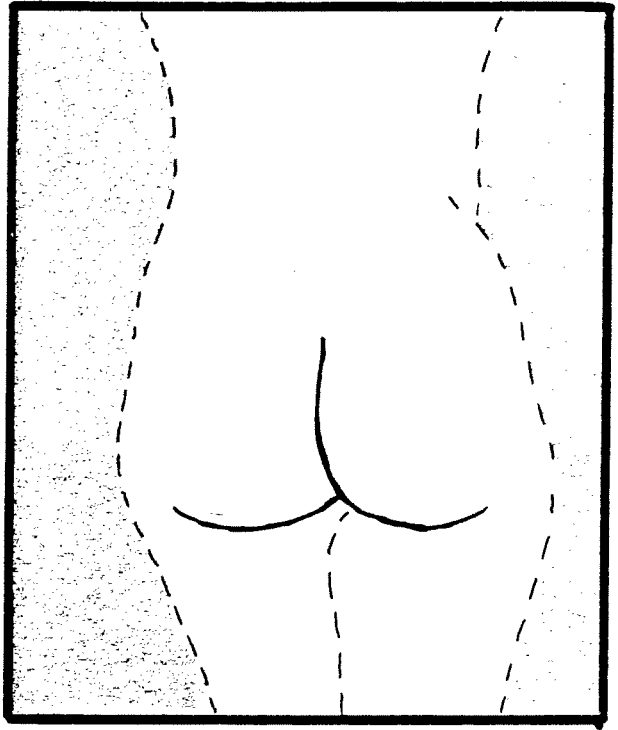

3

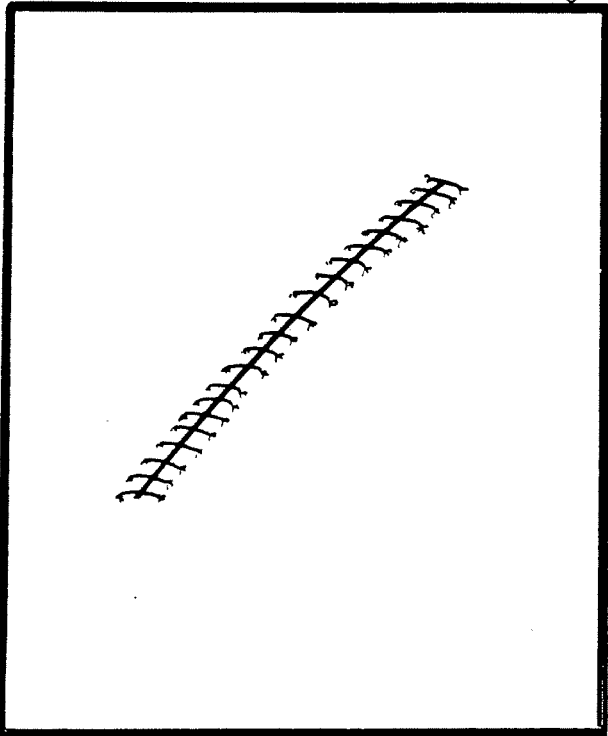

4

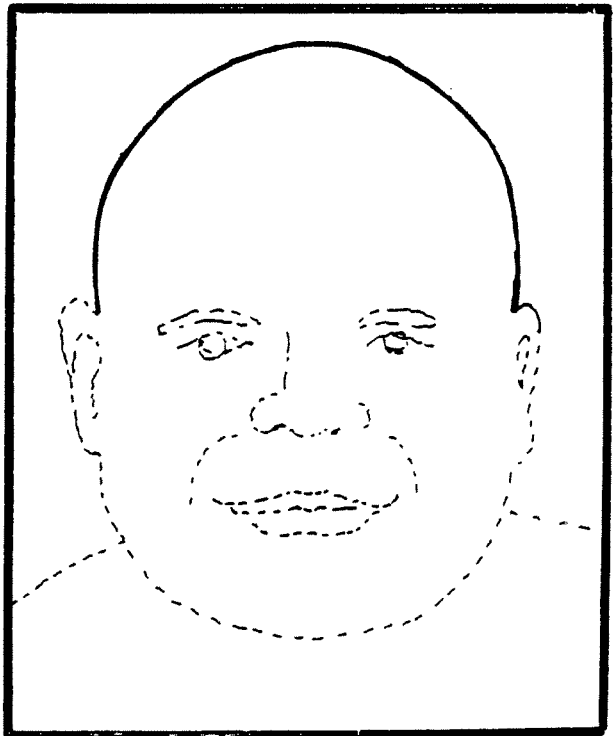

1

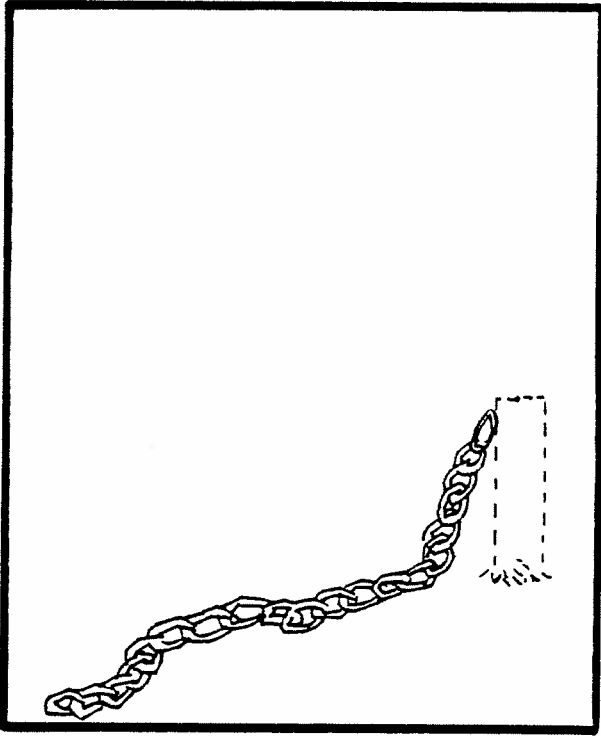

2

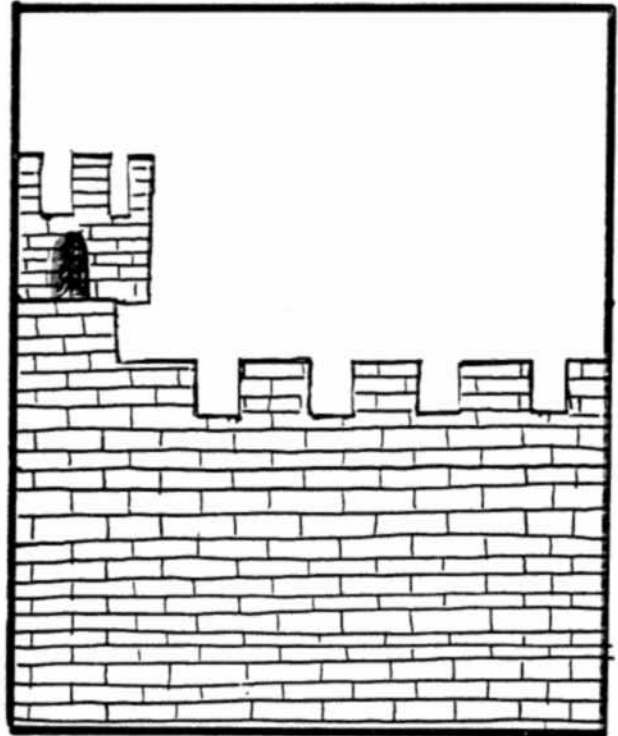

3

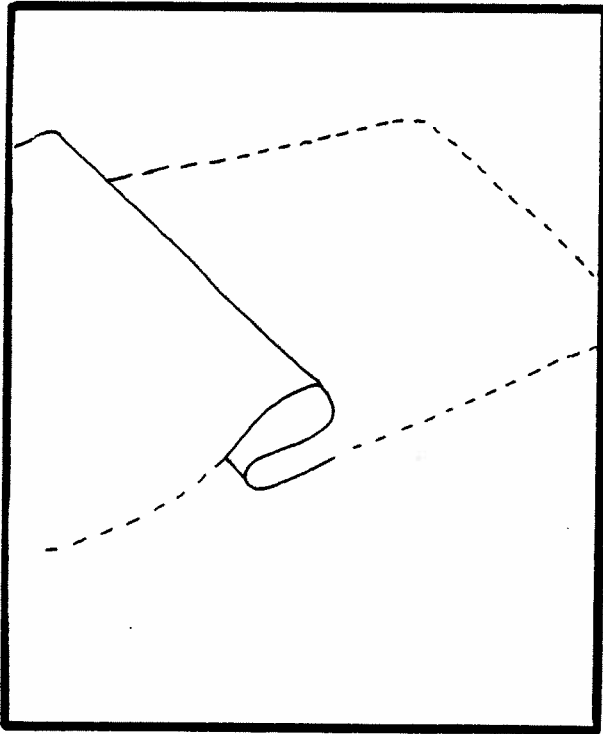

4



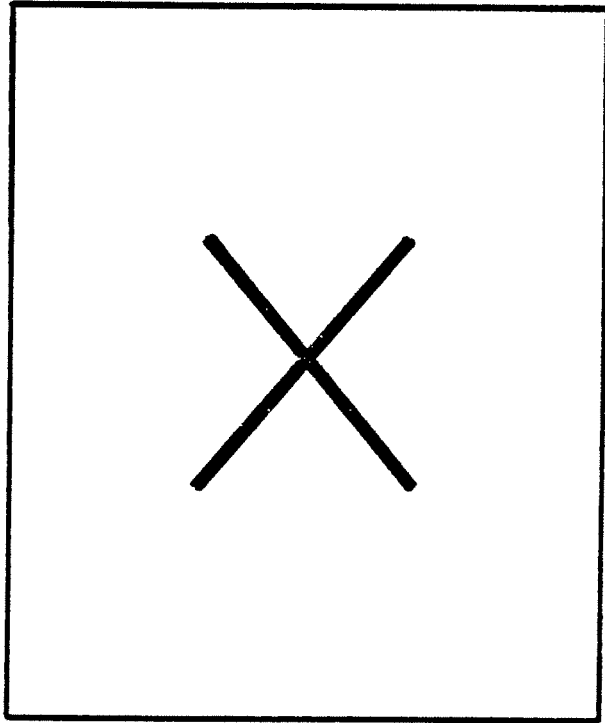

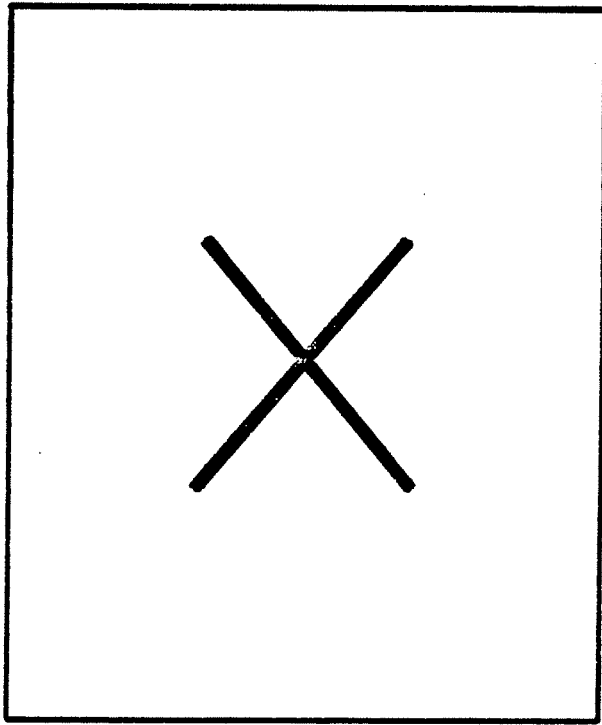

1

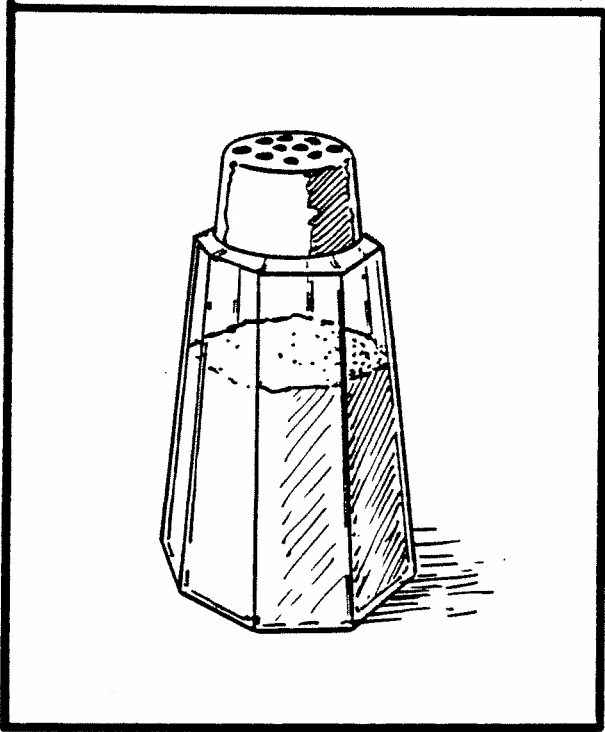

2

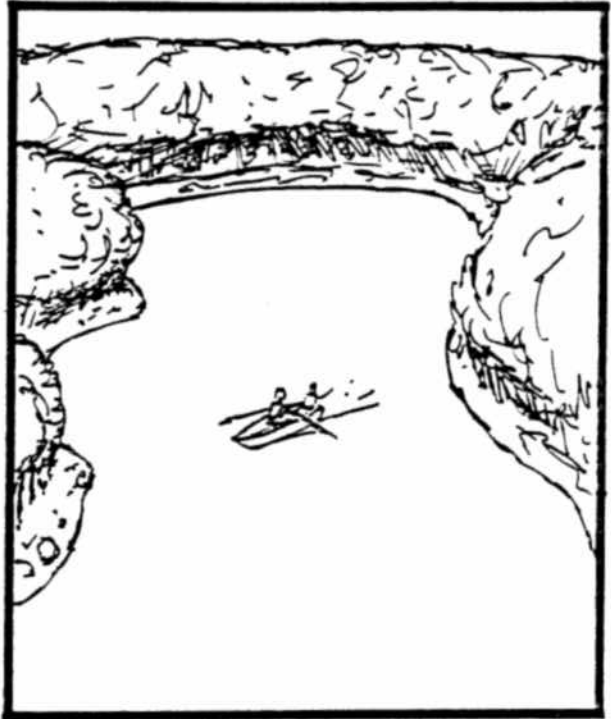

3

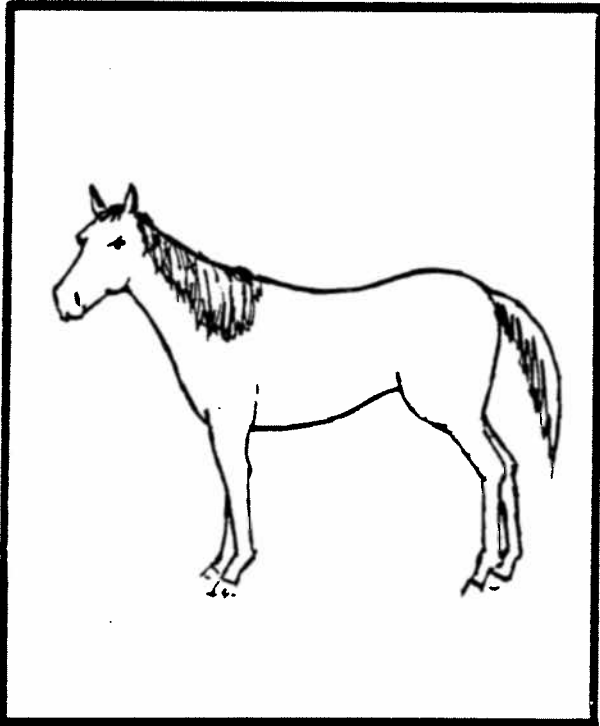

4

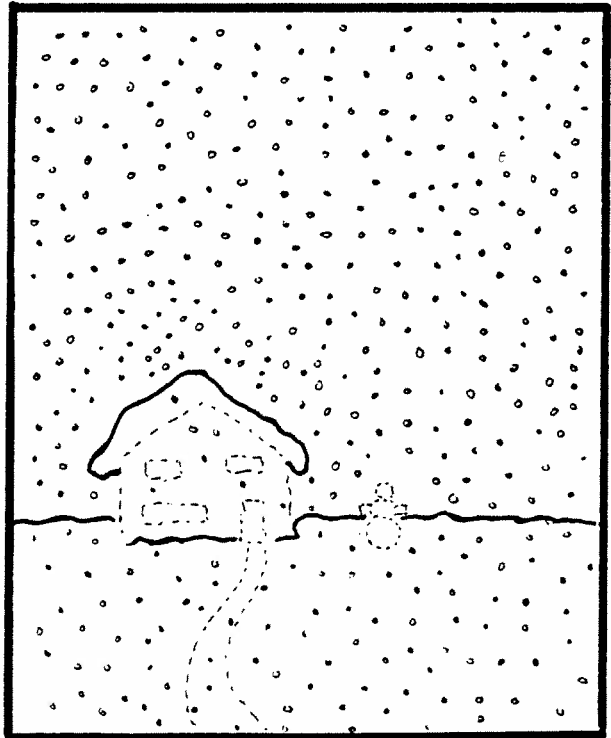

1

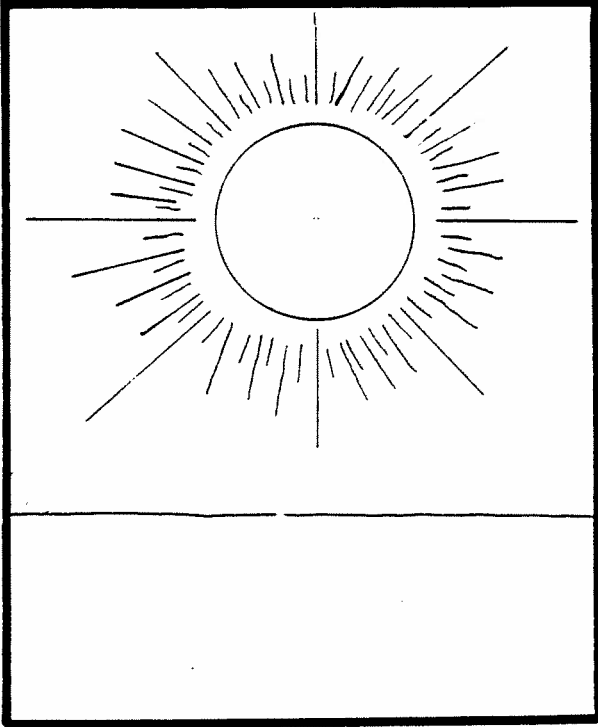

2

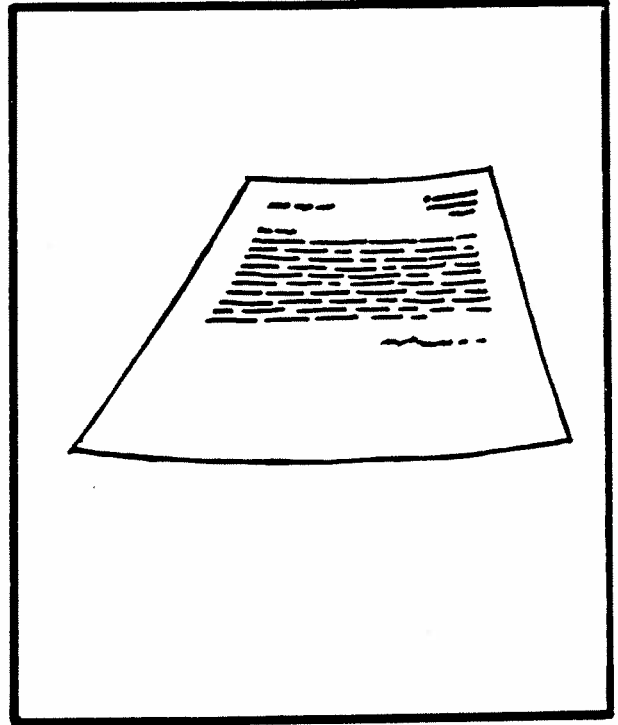

3

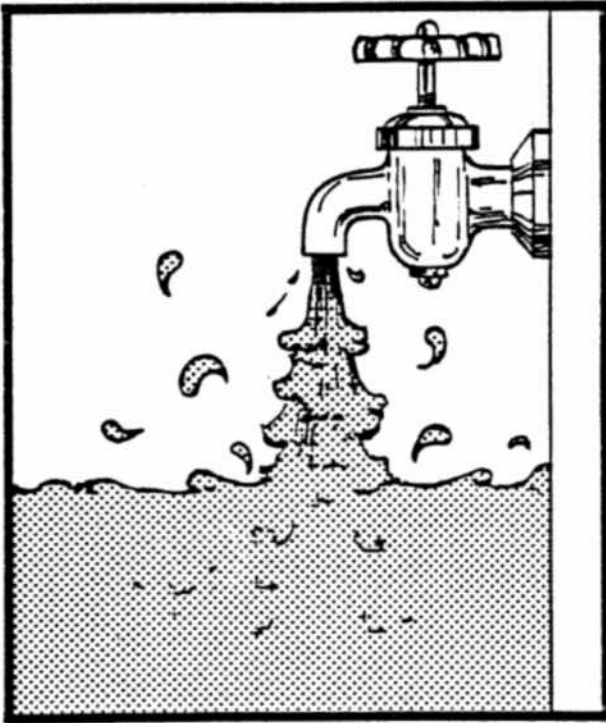

4

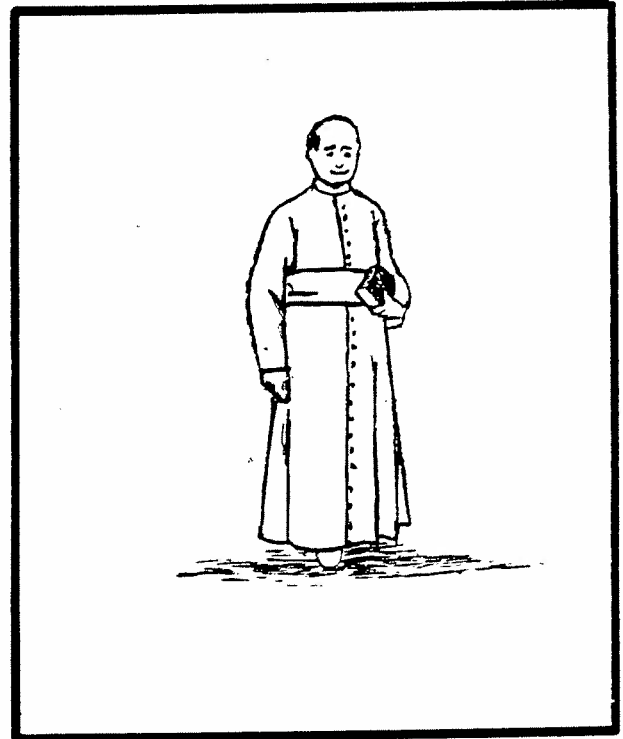

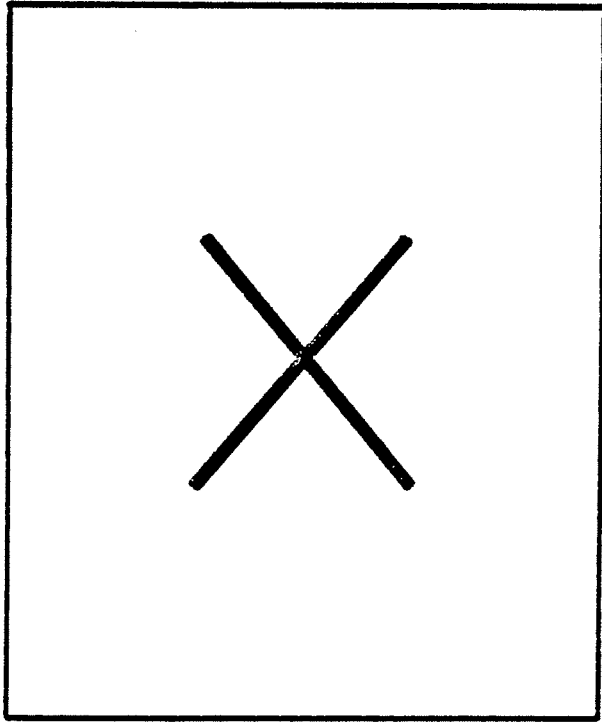

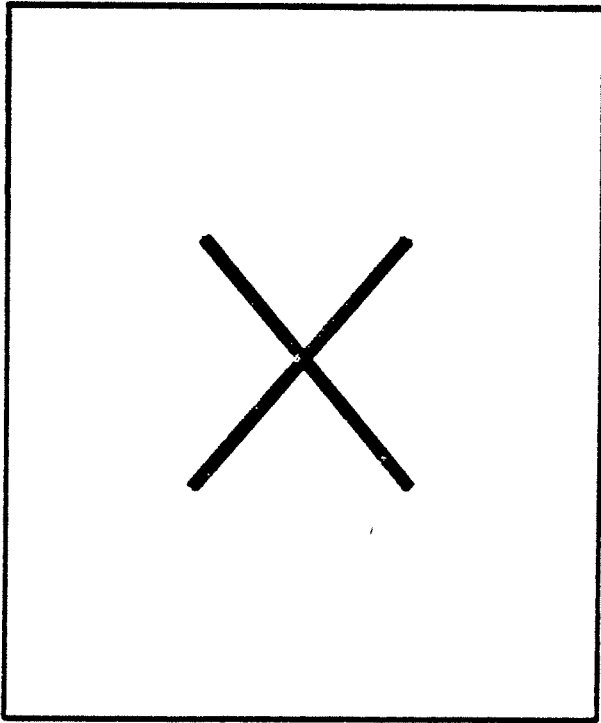



1

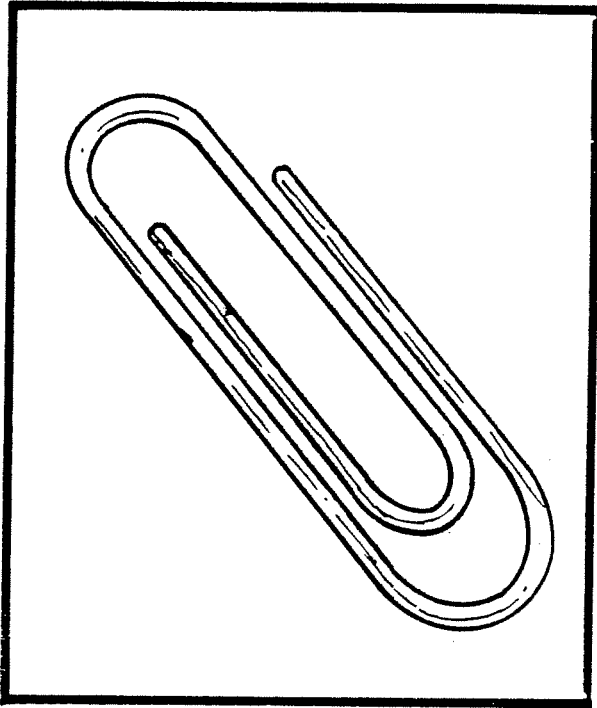

2

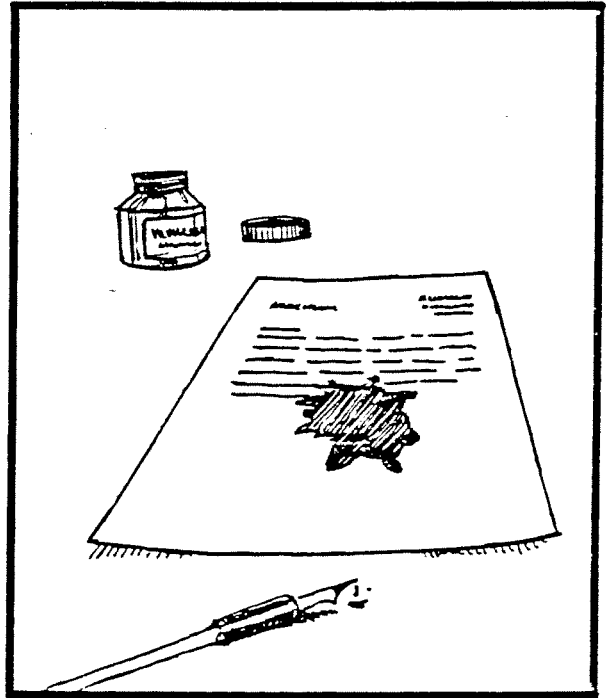

3

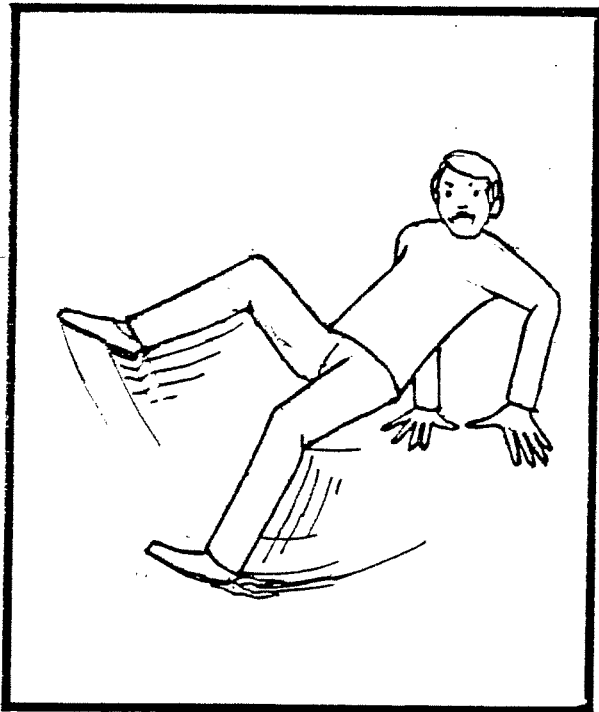

4

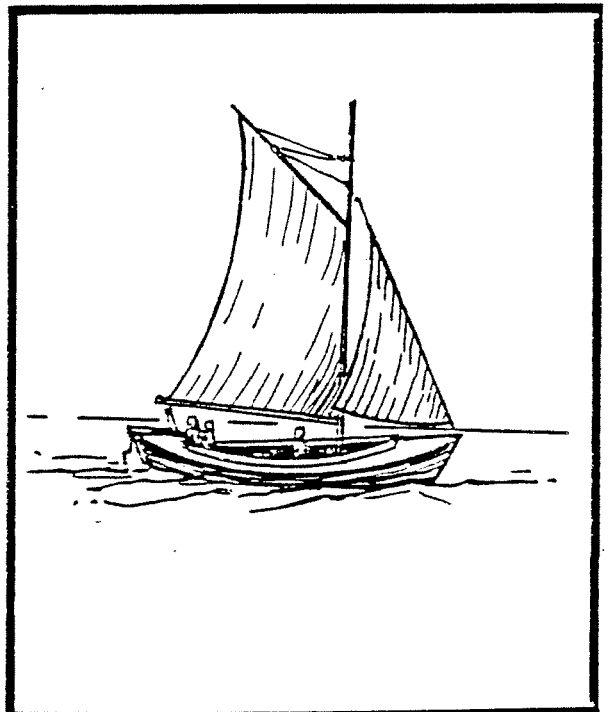

1

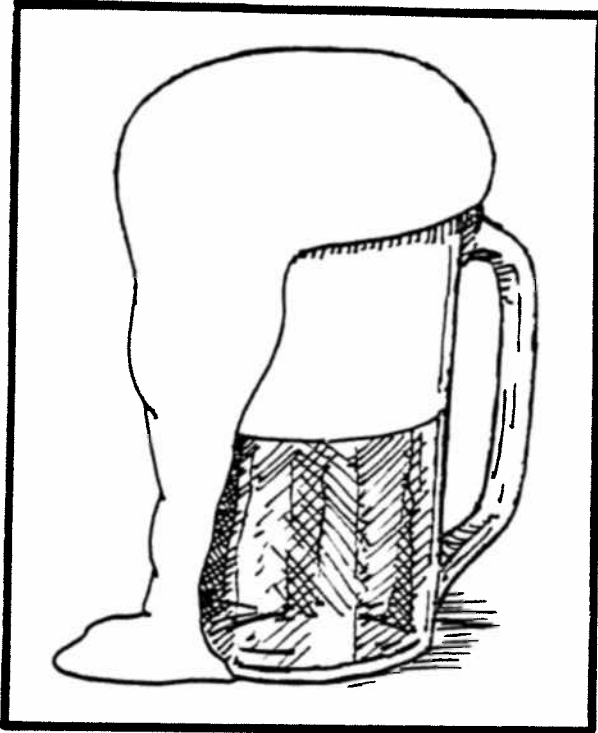

2

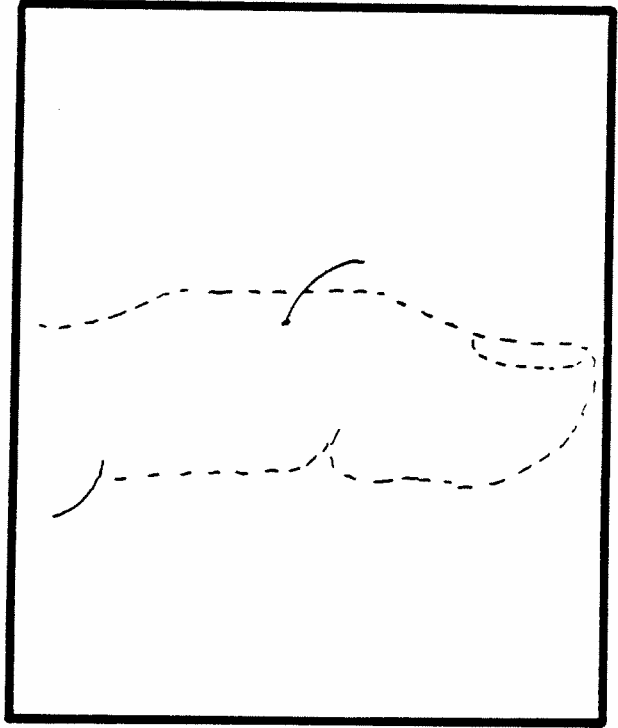

3

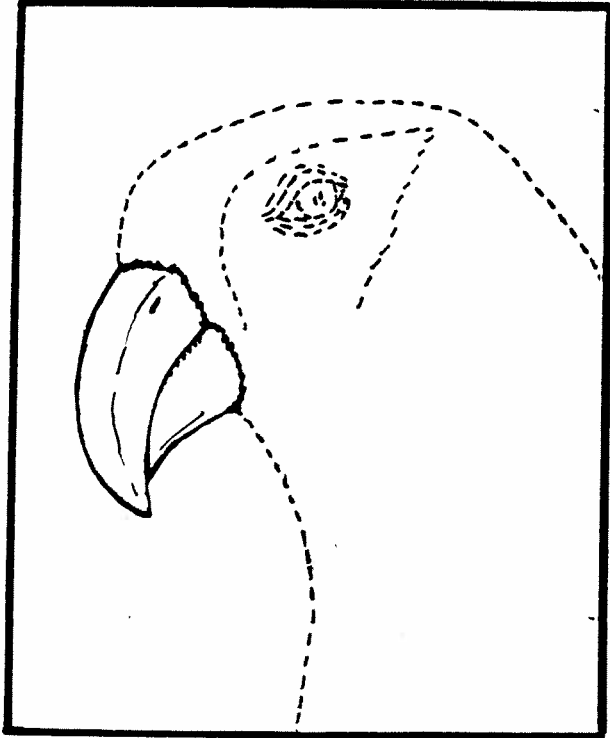

4

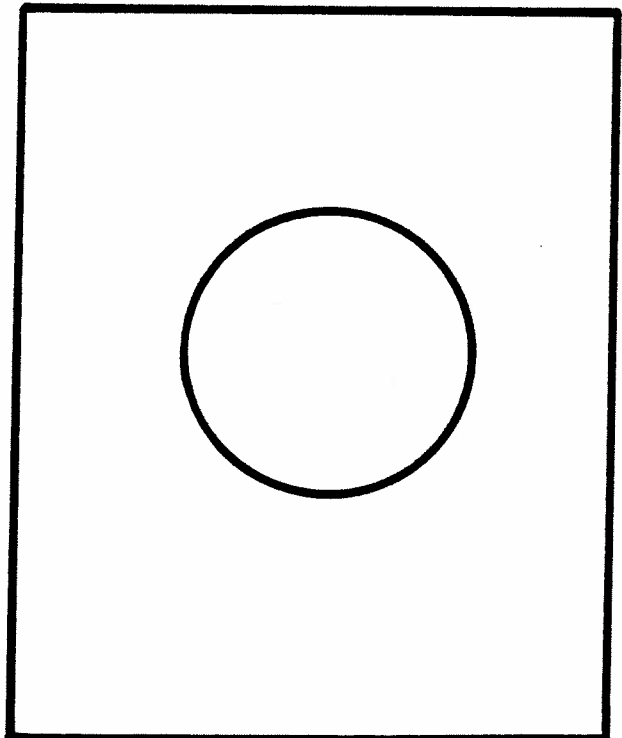

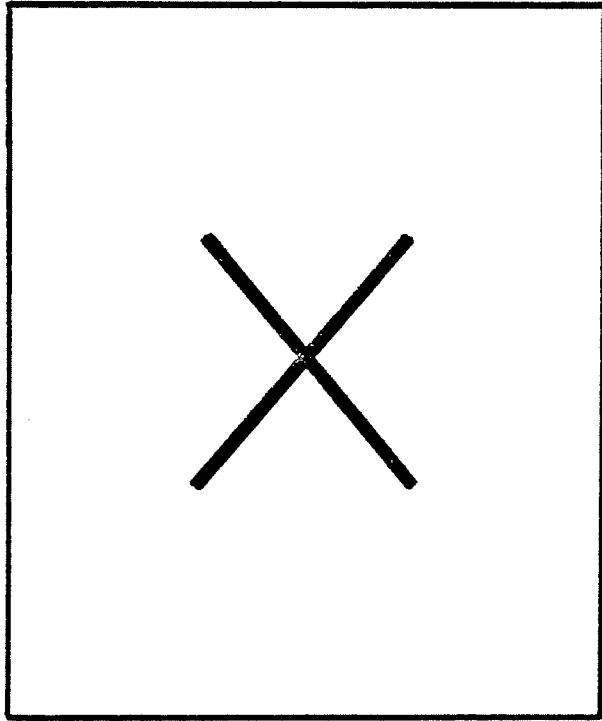

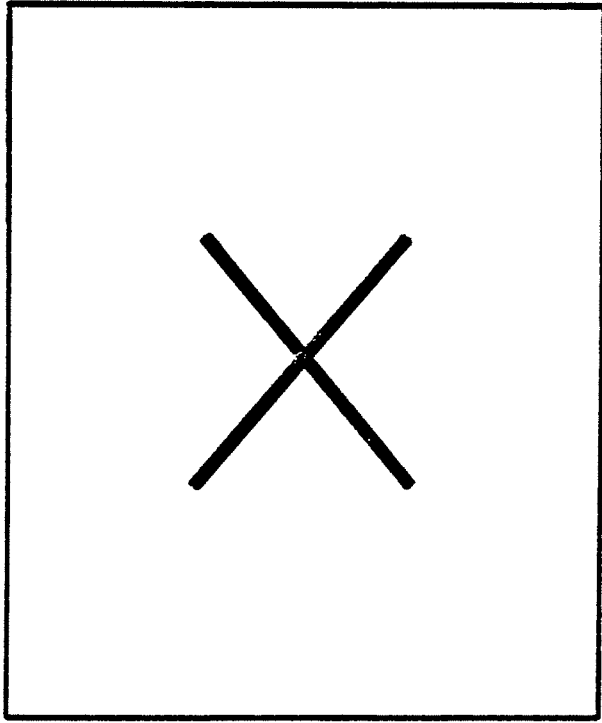

1

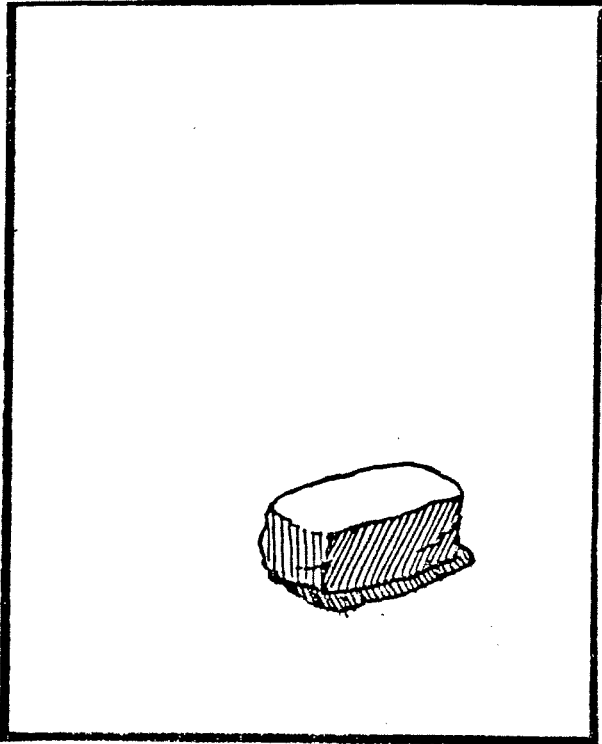

2



3

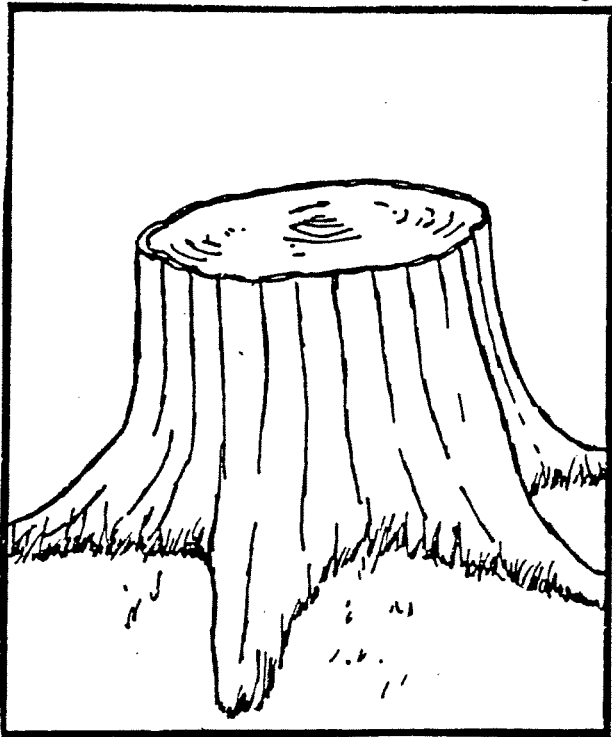

4

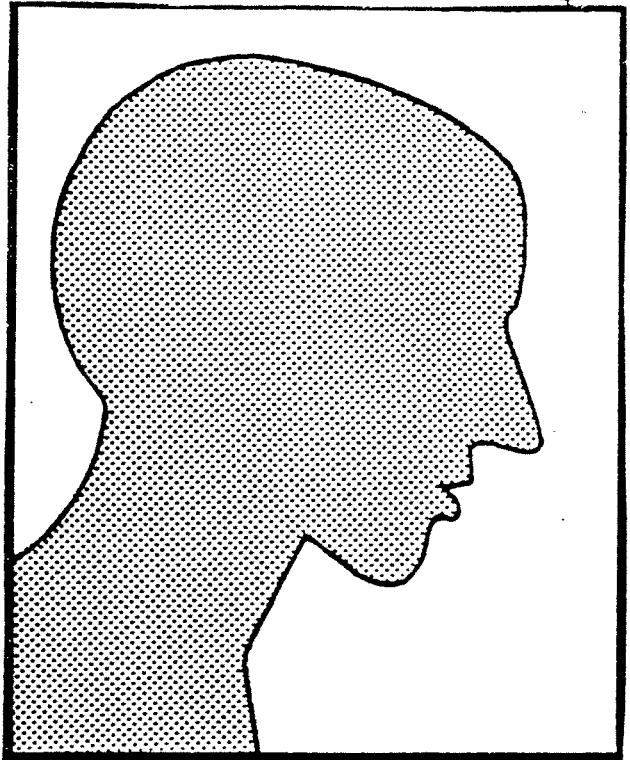

1

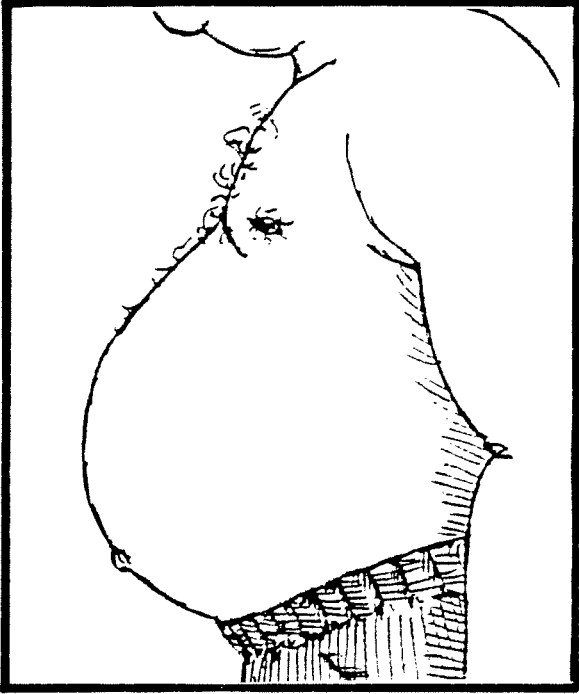

2

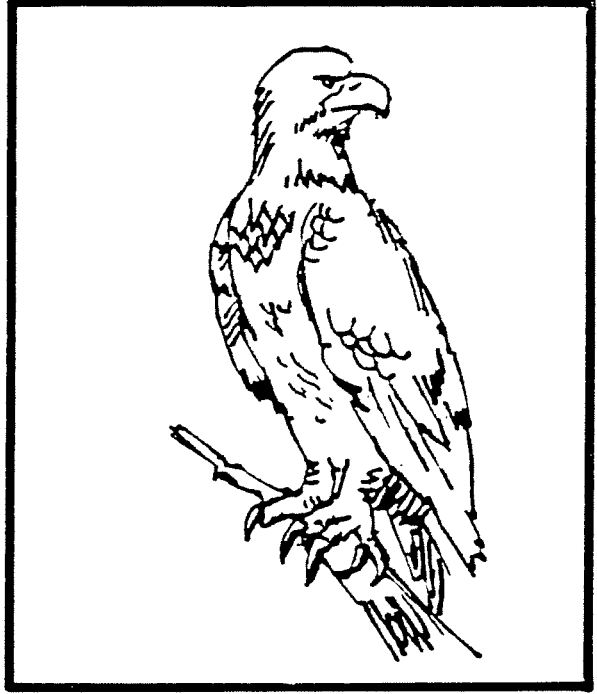

3

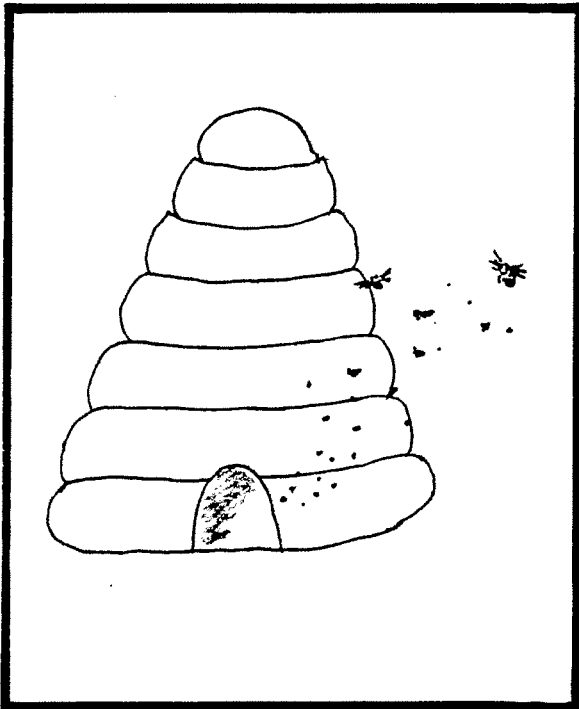

4

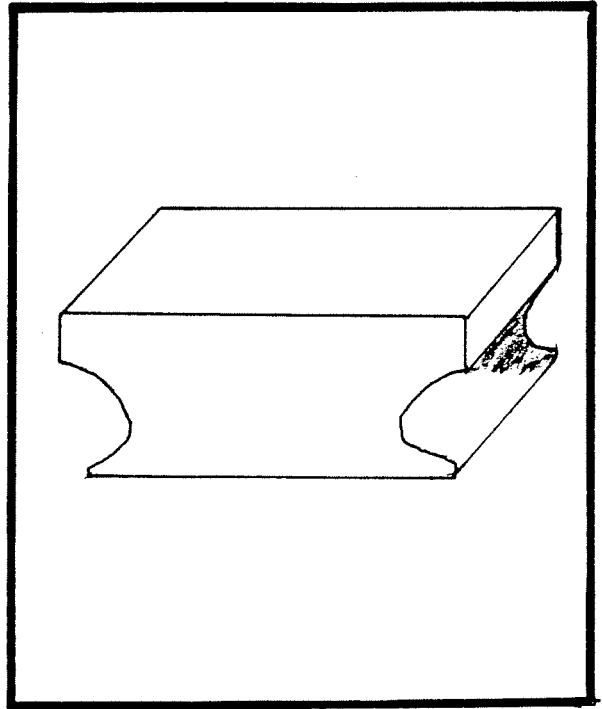

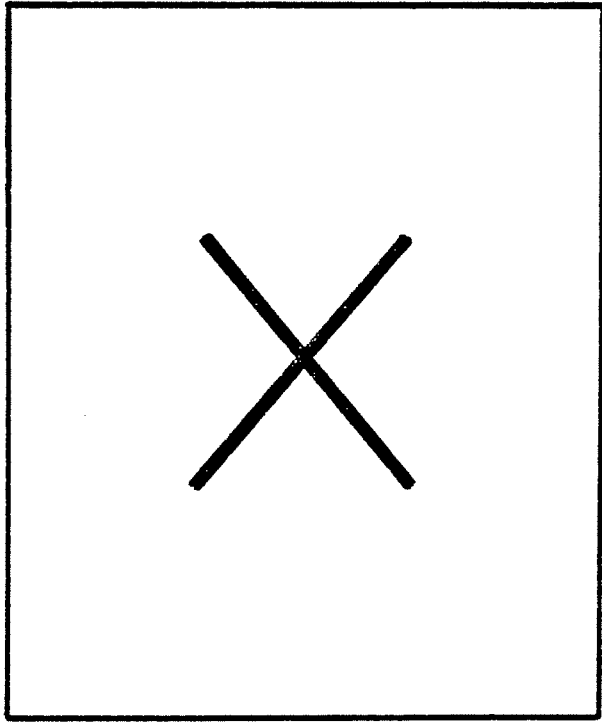

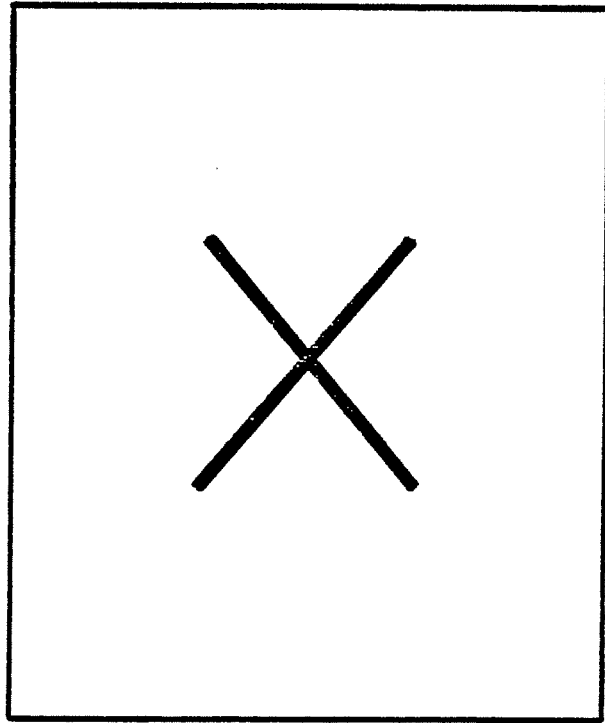



1

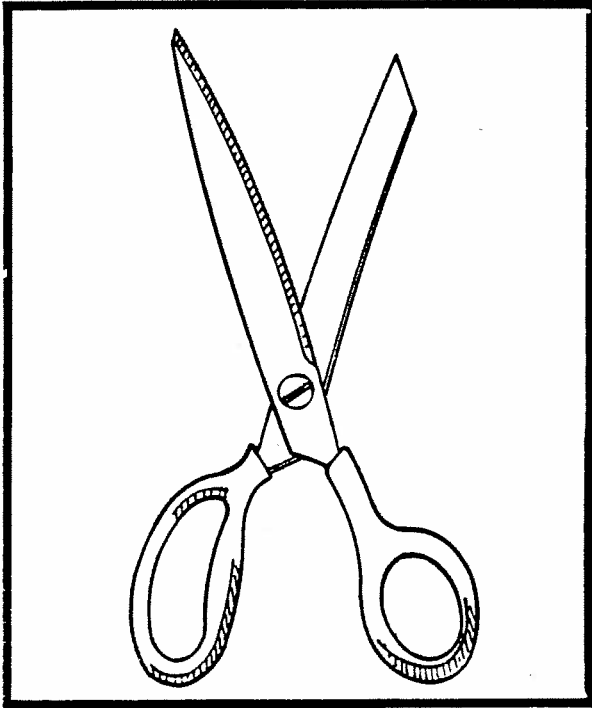

2

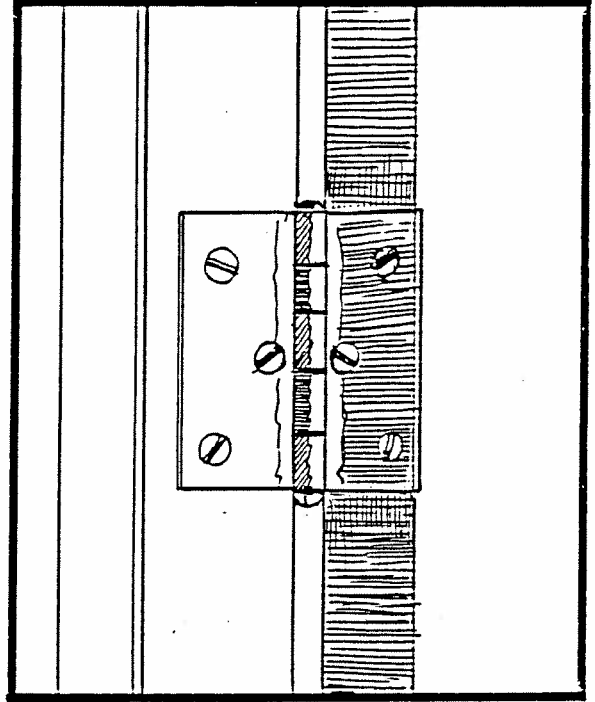

3

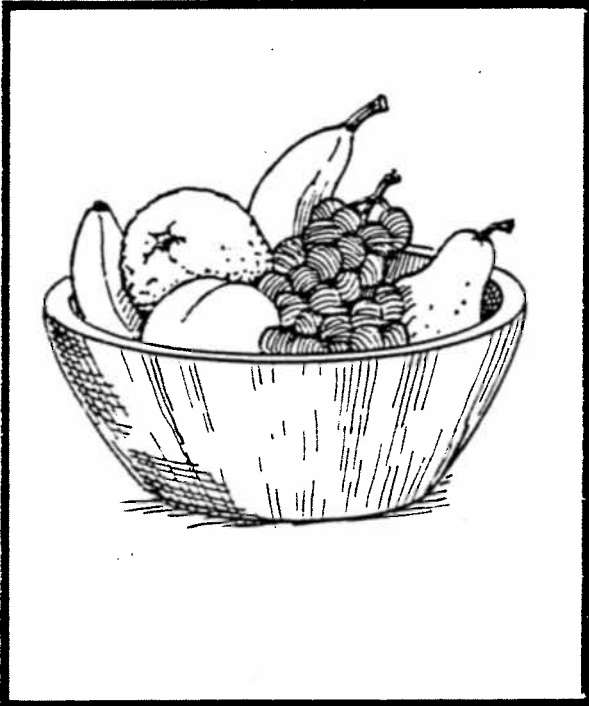

4

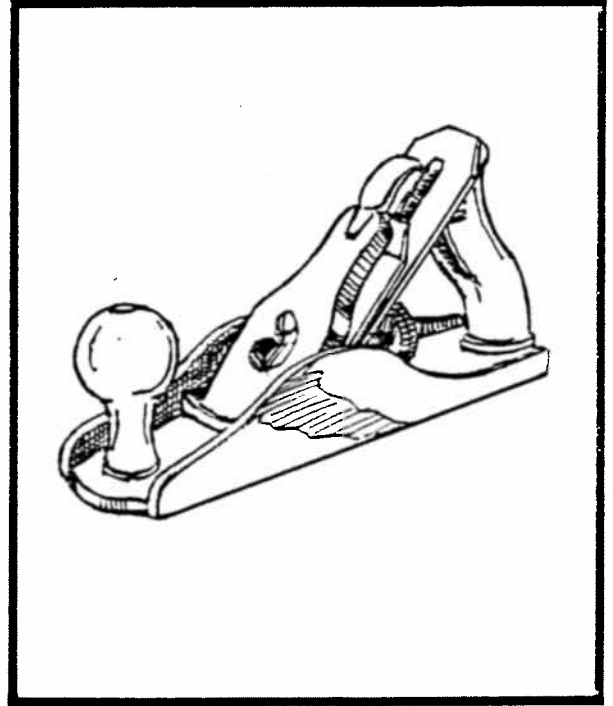

1



2

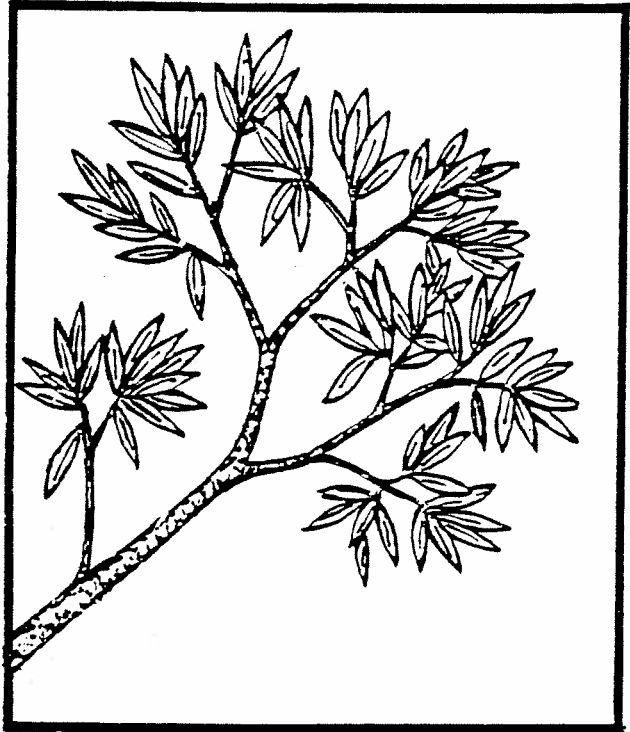

3

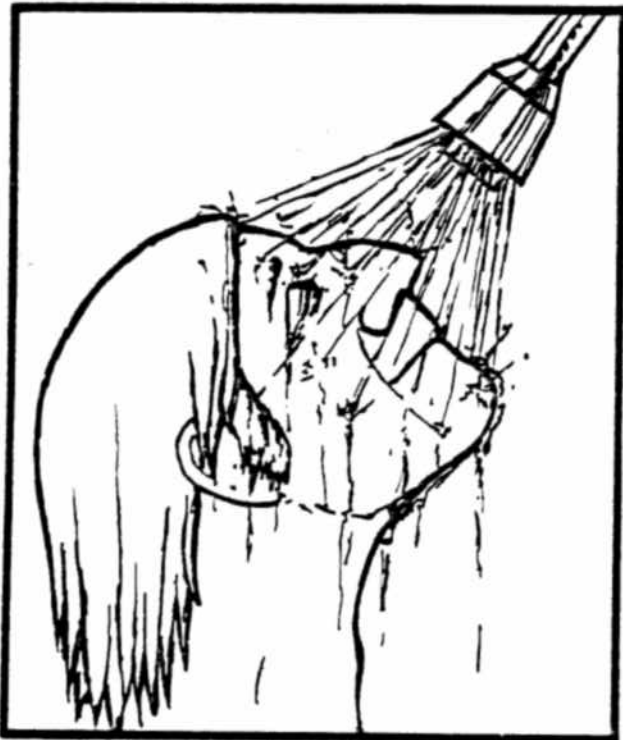

4

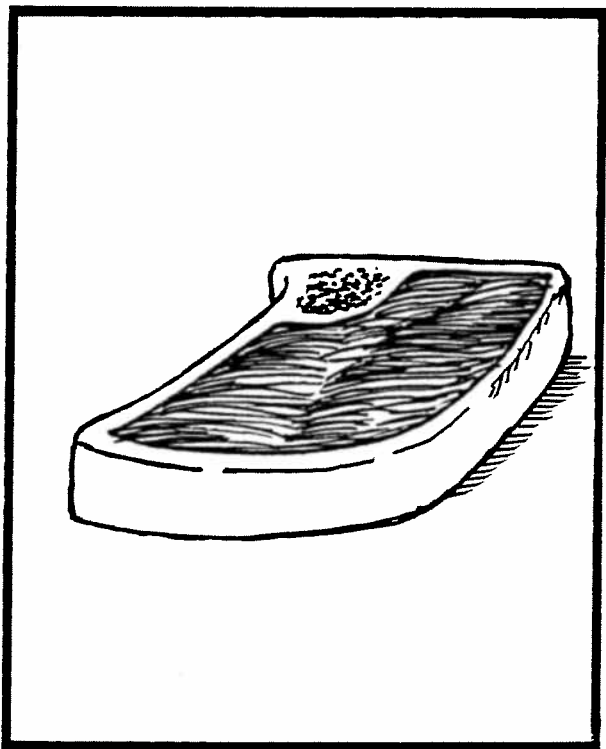

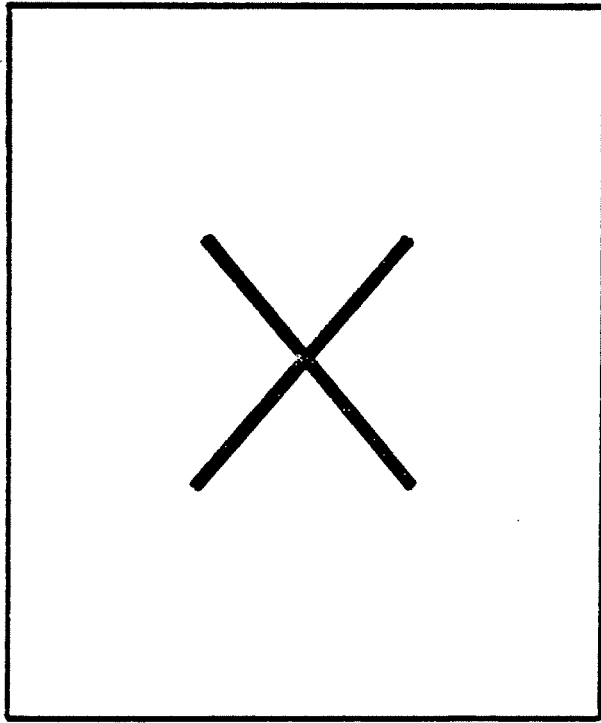

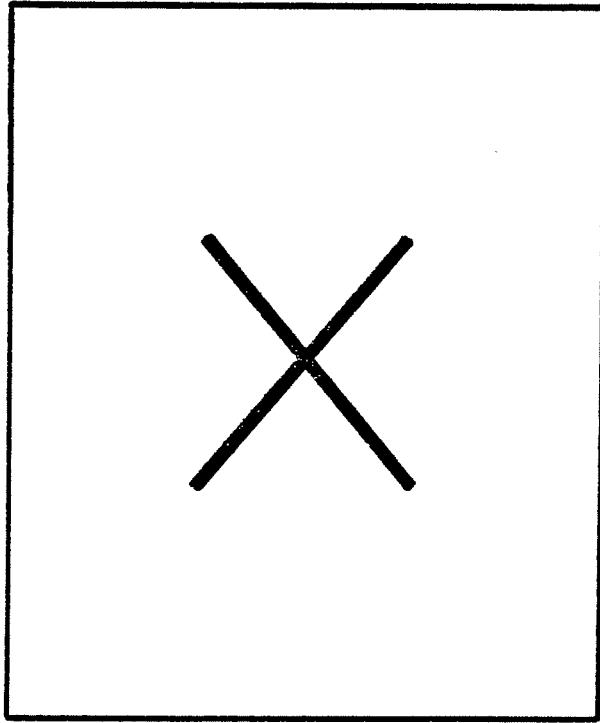

1

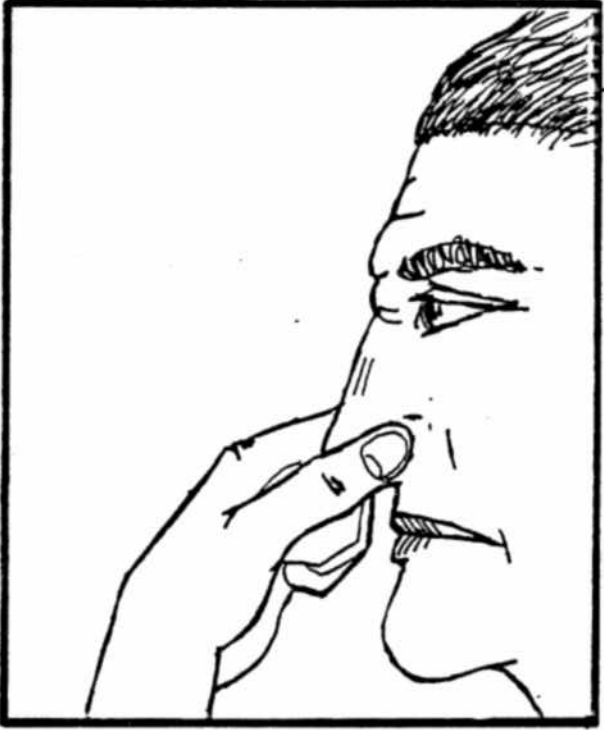

2

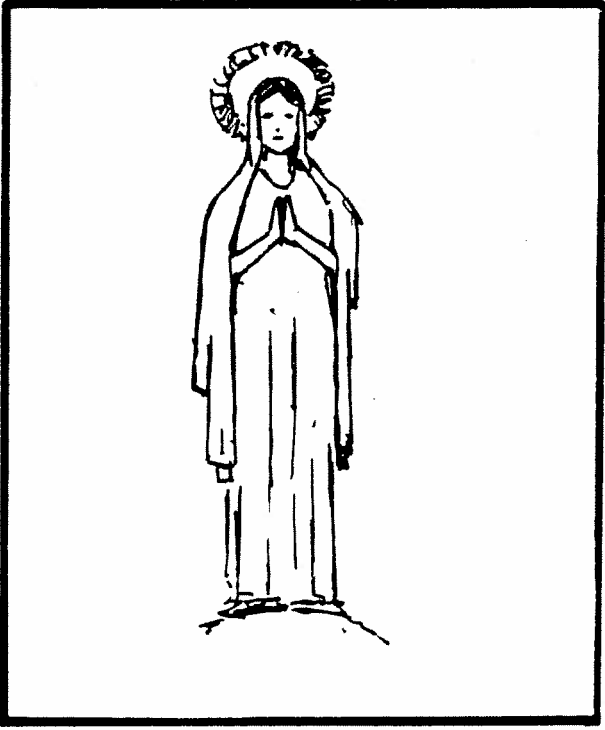

3

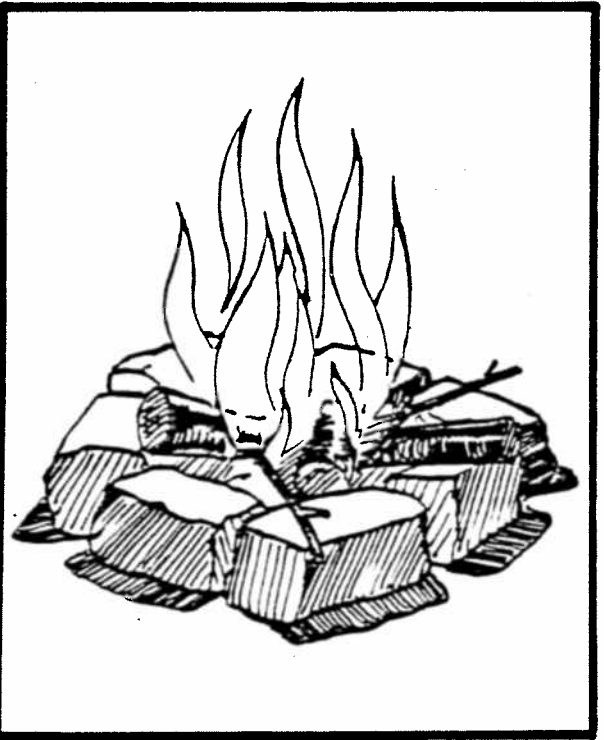

4

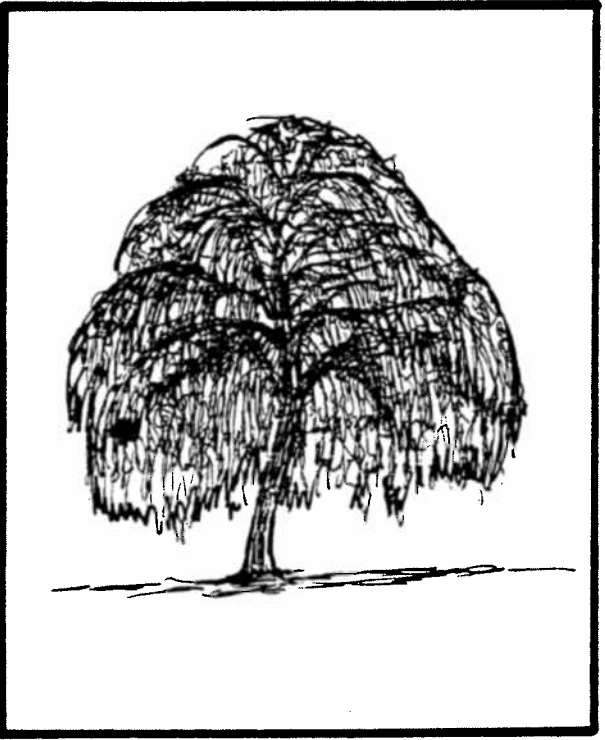

1

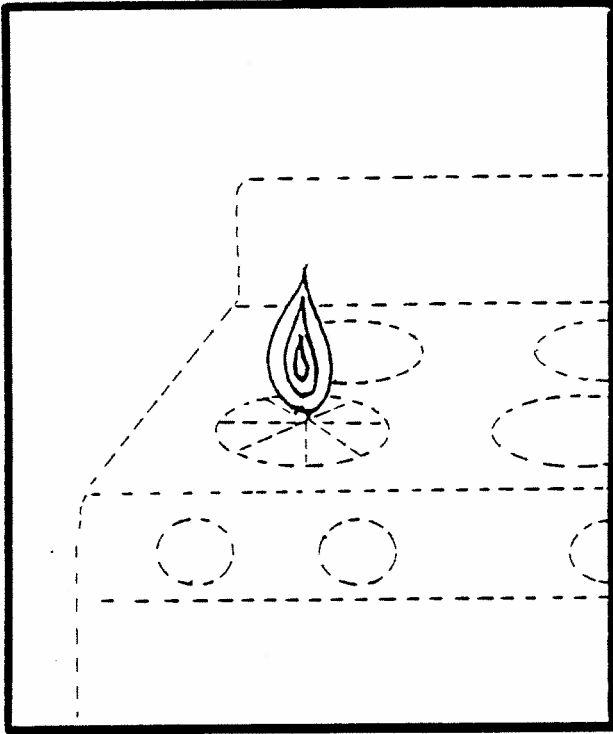

2

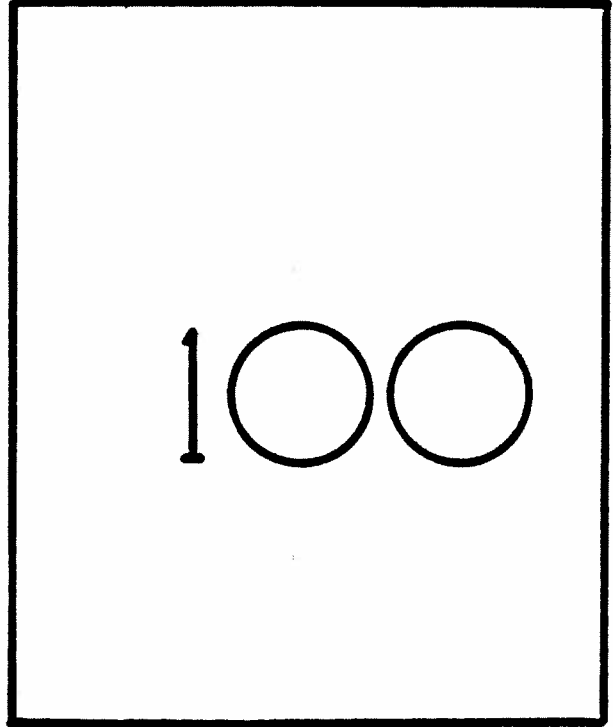

3



4

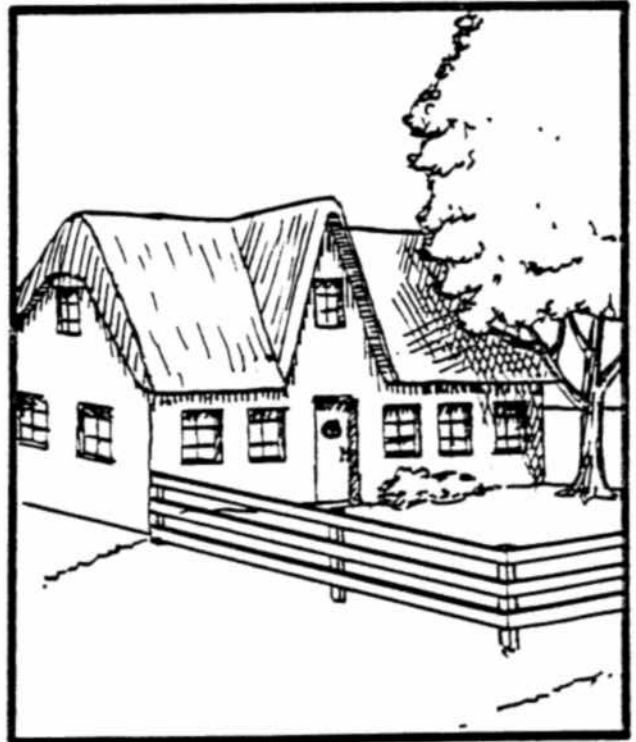

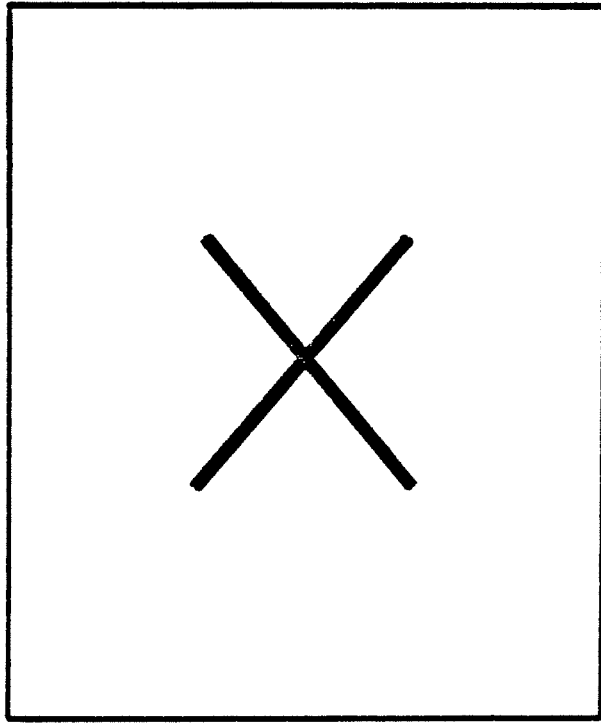

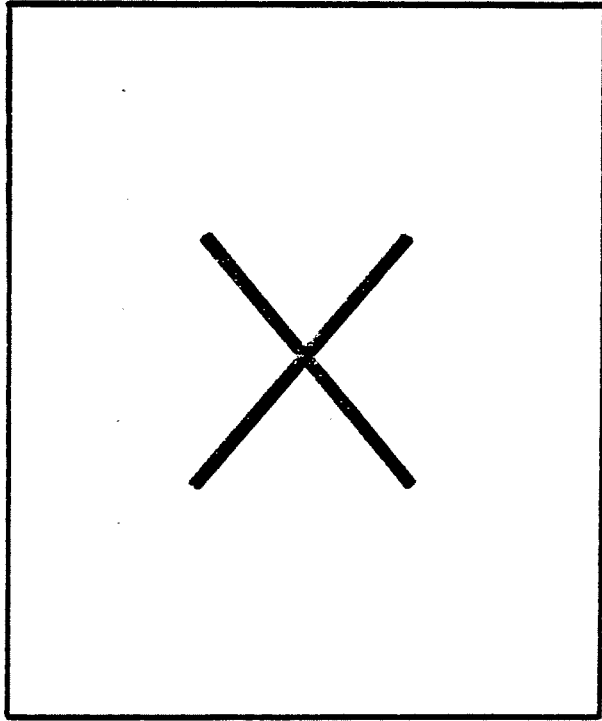



1

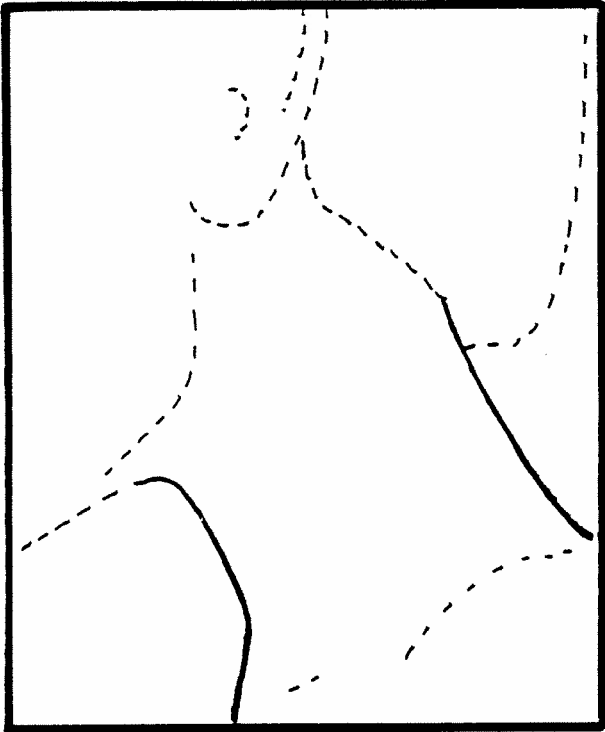

2

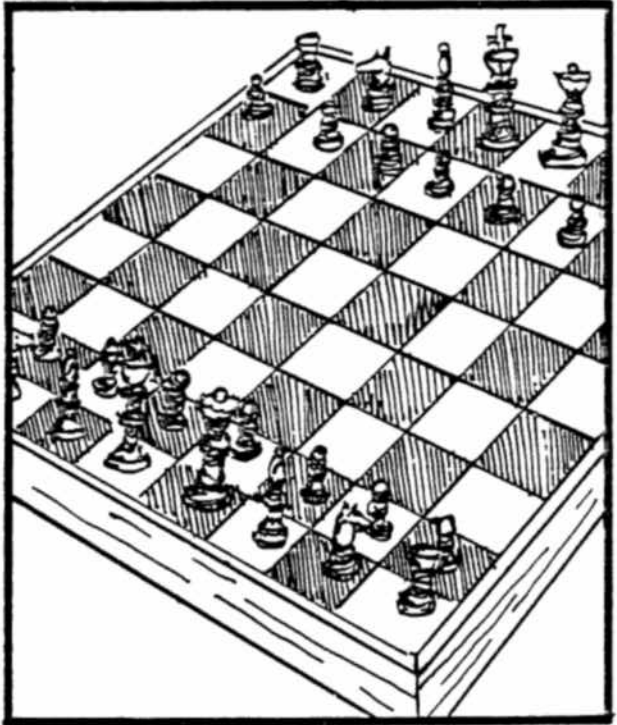

3



4

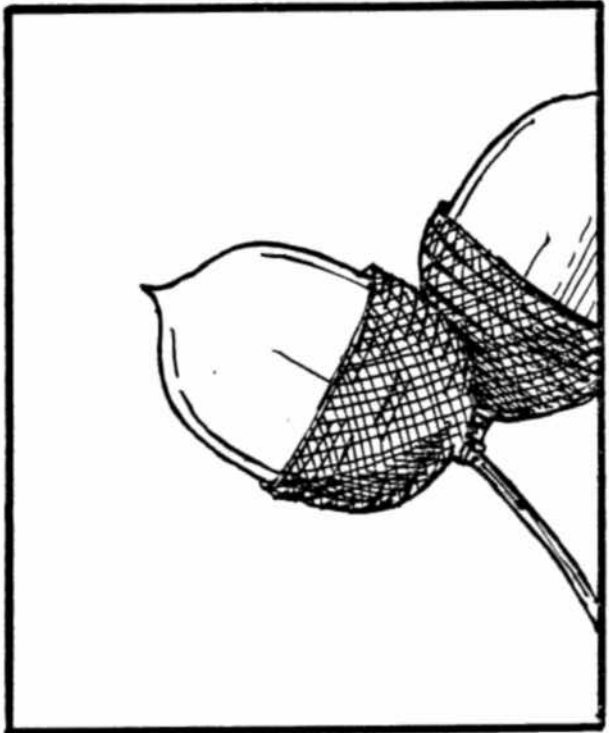



## MONDATTANI SZERKEZETEK MEGÉRTÉSE

1

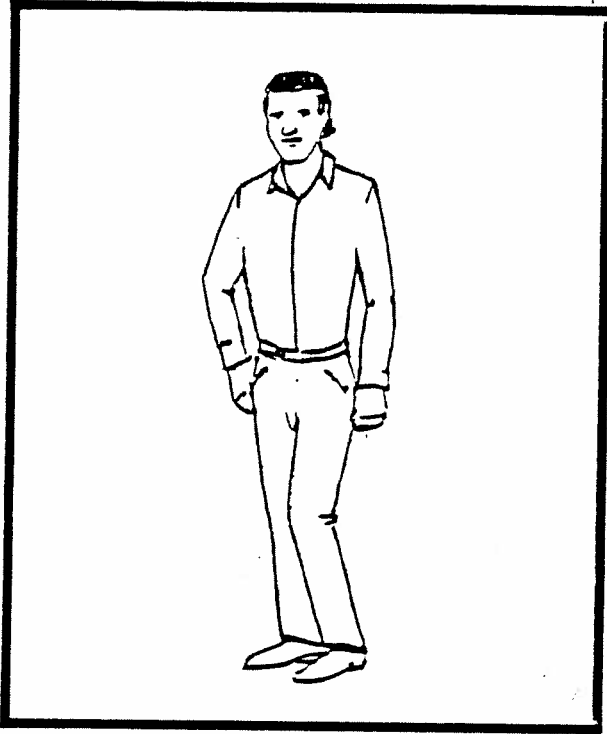

2

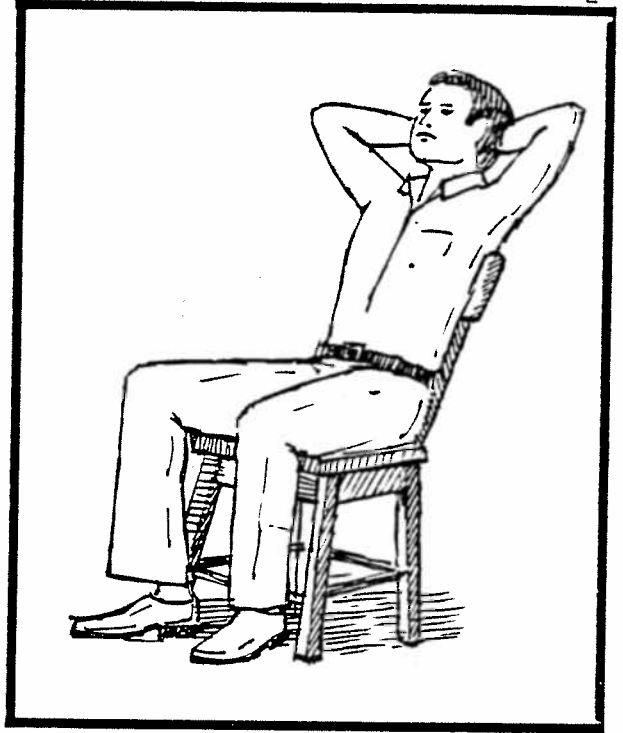

3

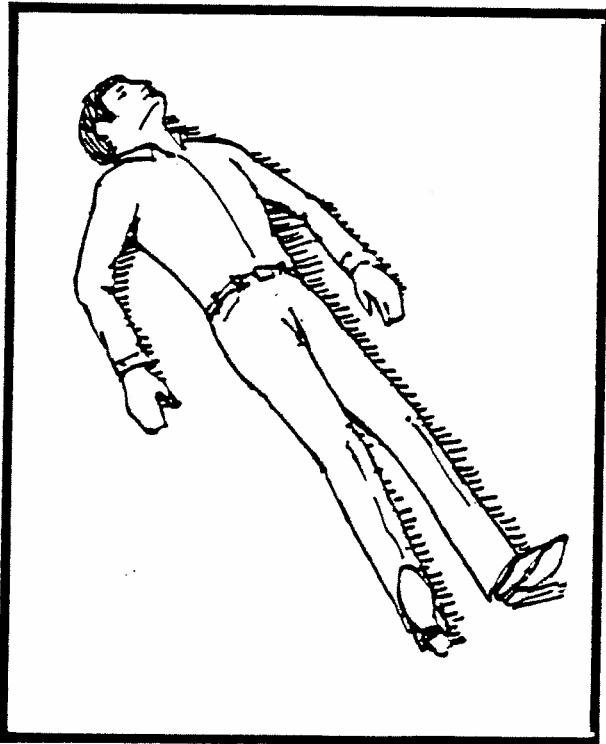

4



Példa

1



2

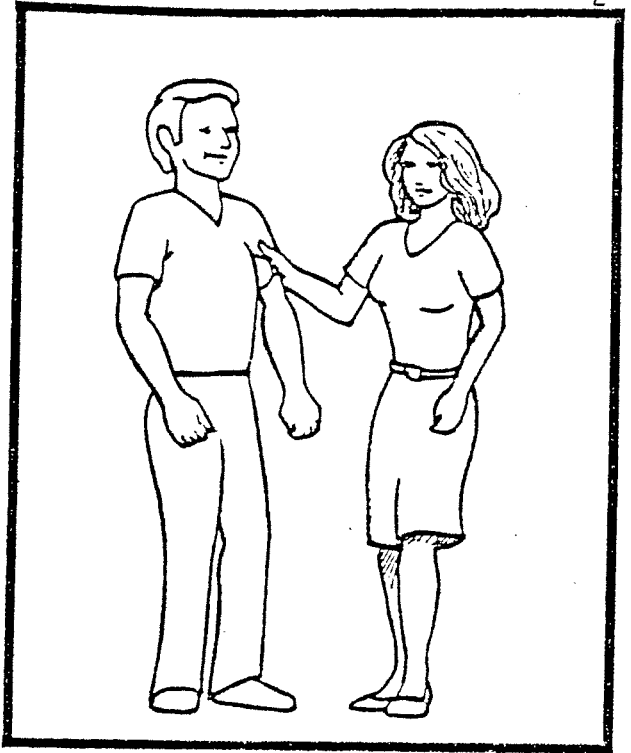

3

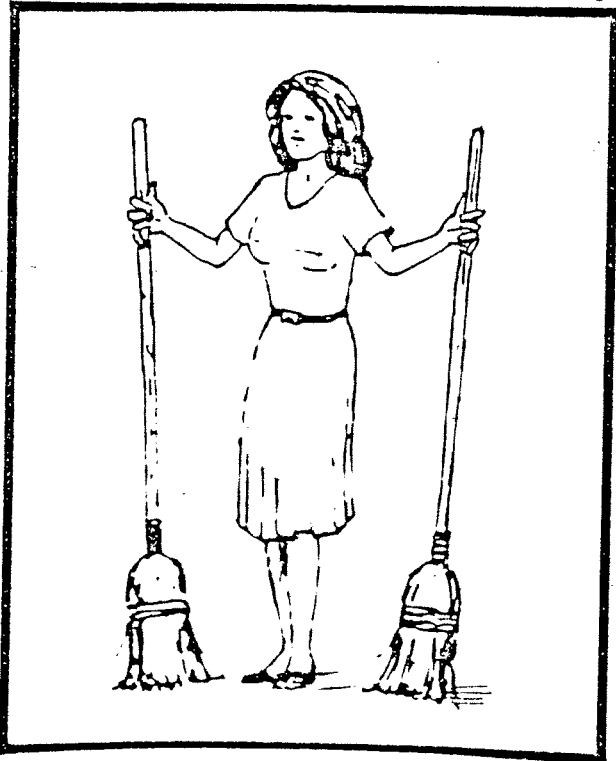

4

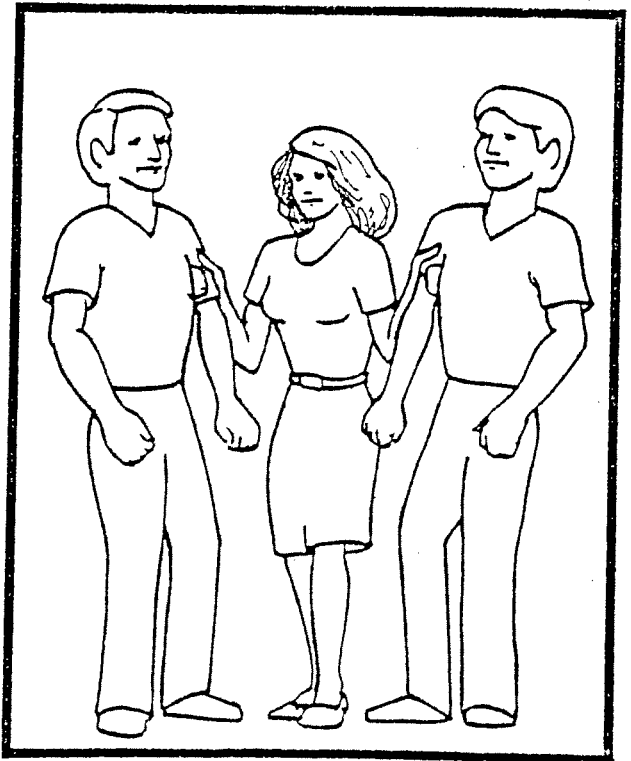

1

1

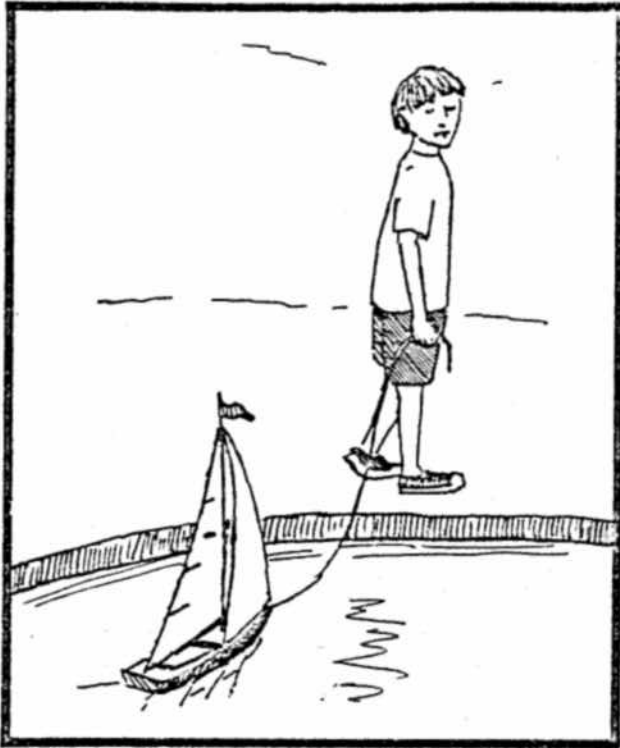

2

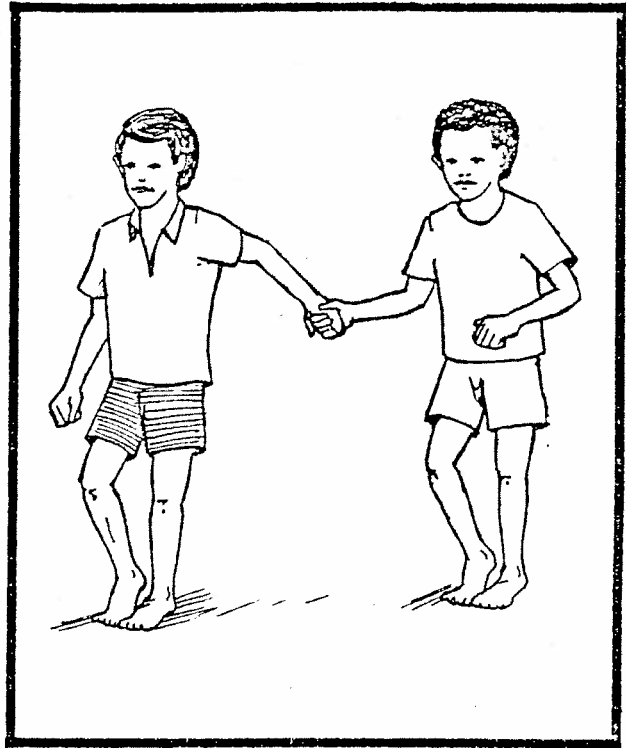

3

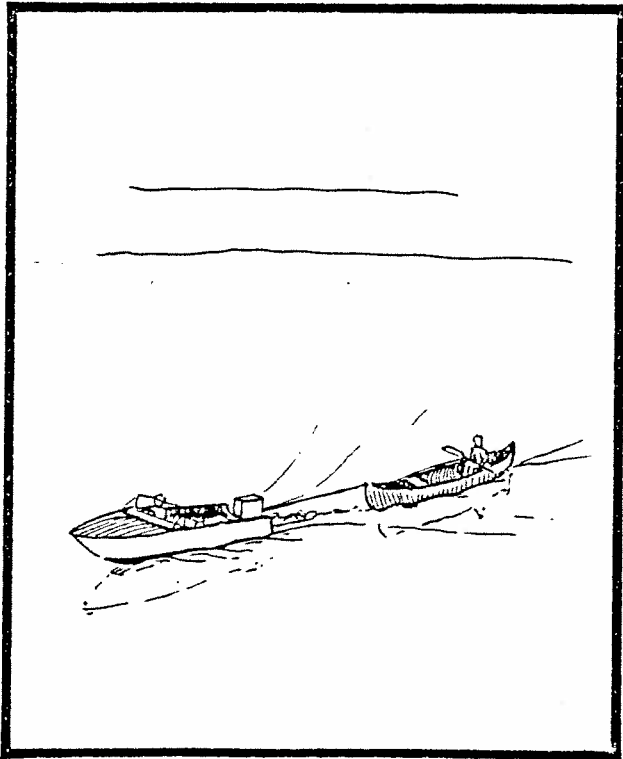

4

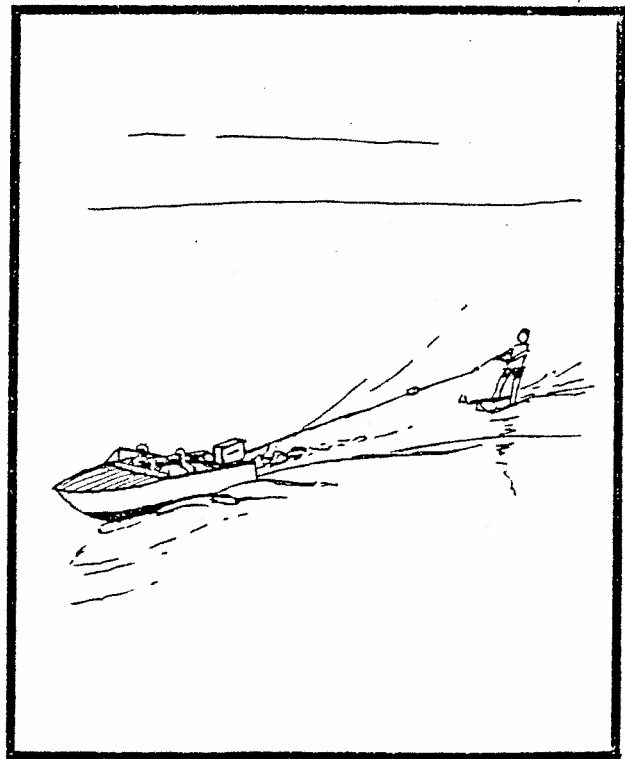

1



2



3

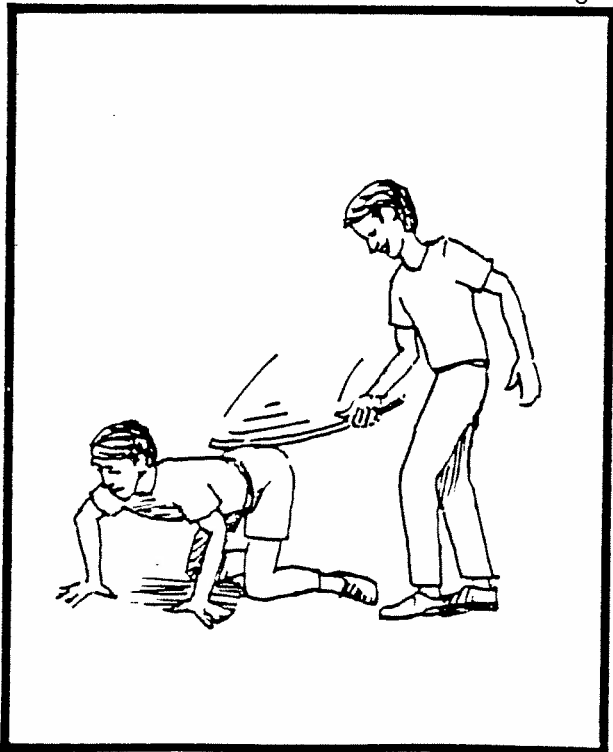

4

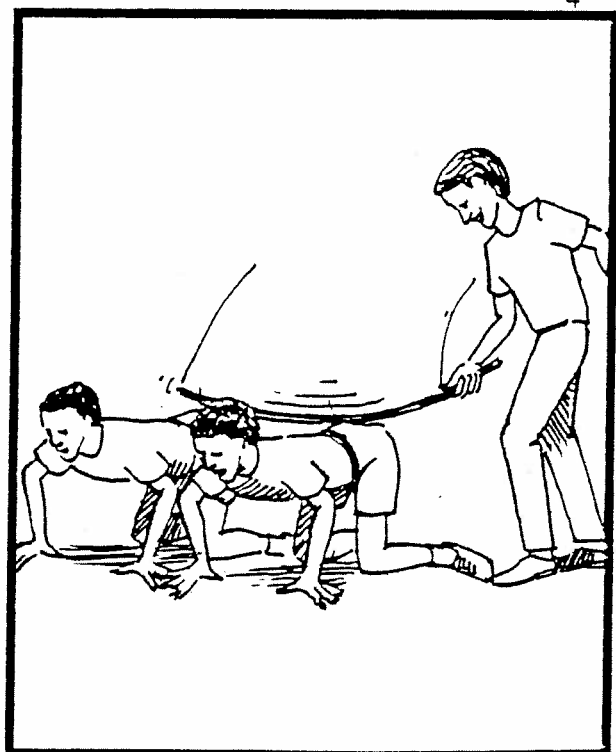

1

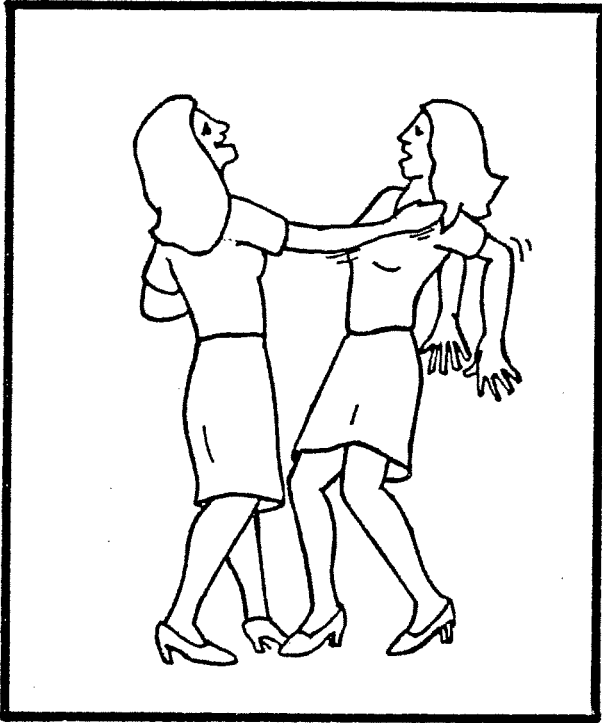

2

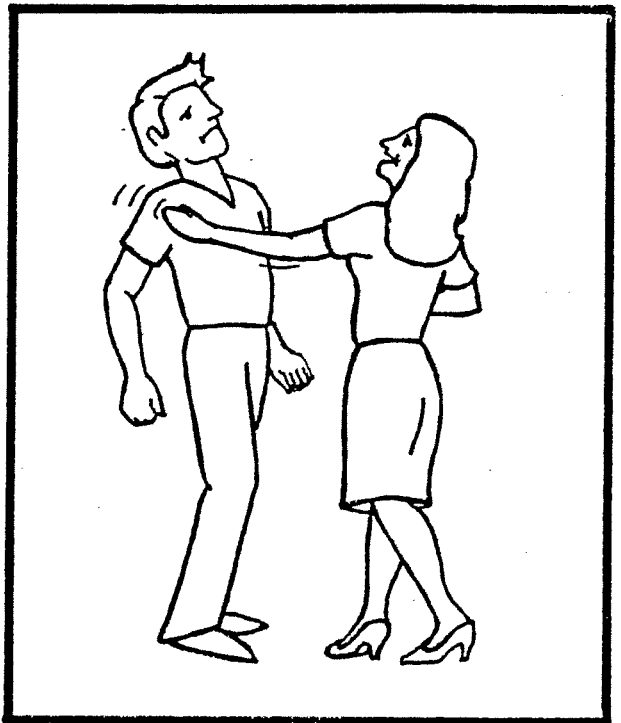

3

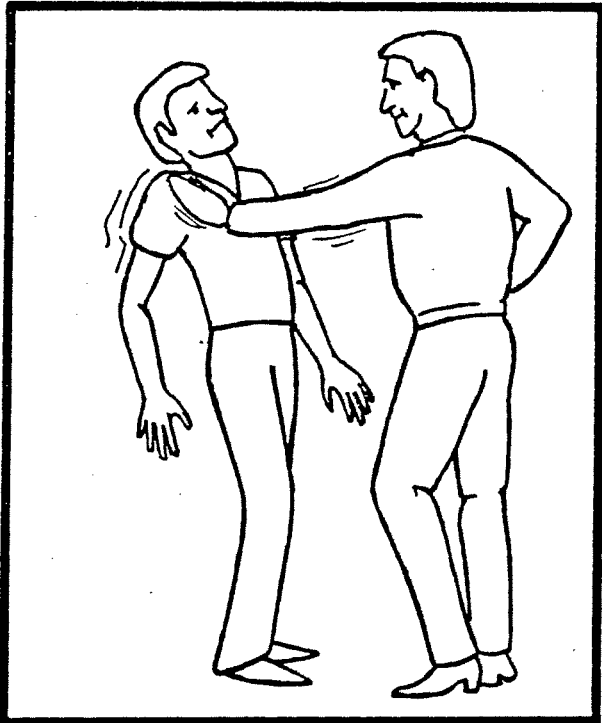

4

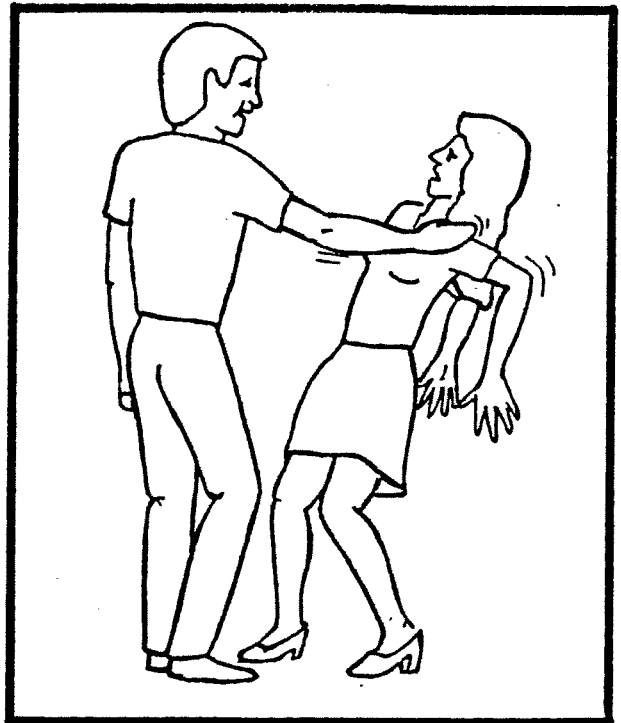

4



1

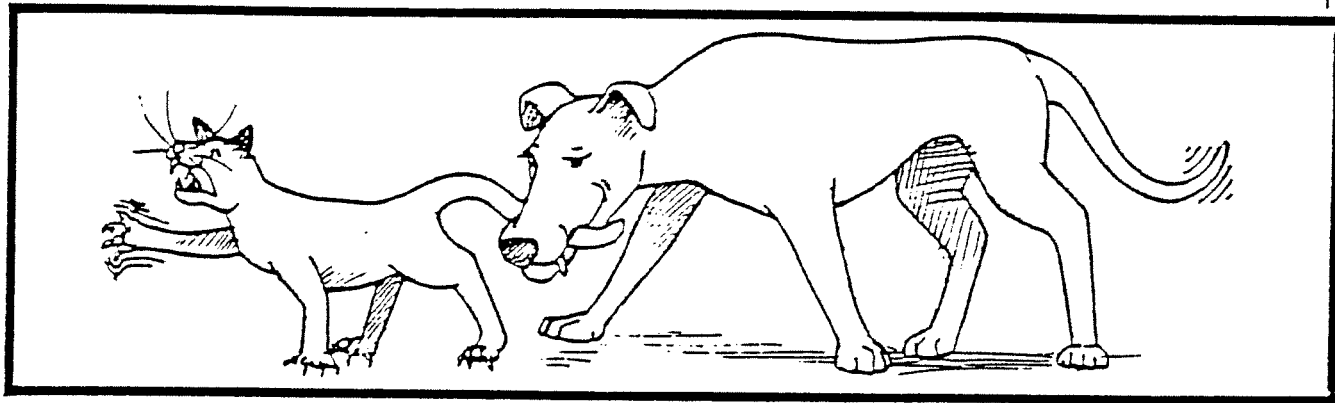

2

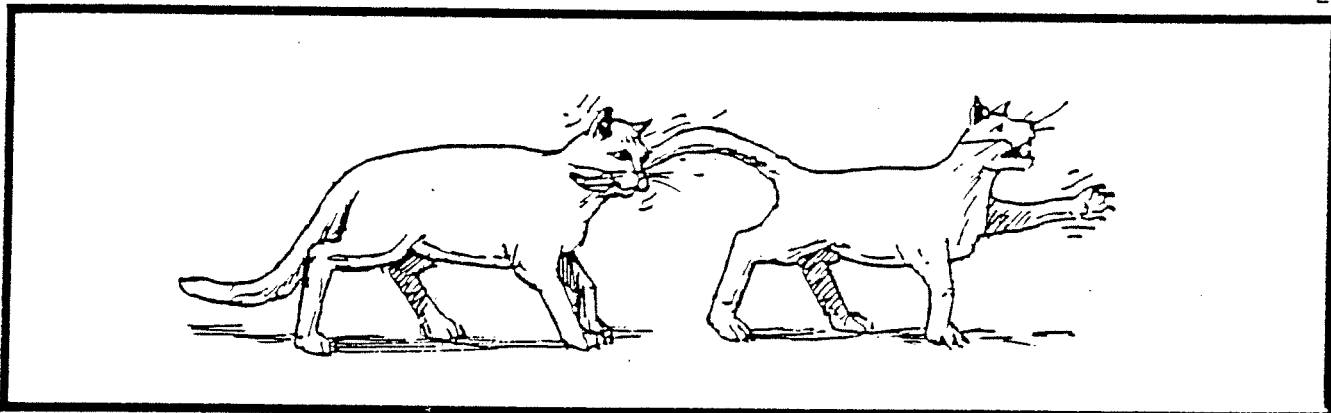

3

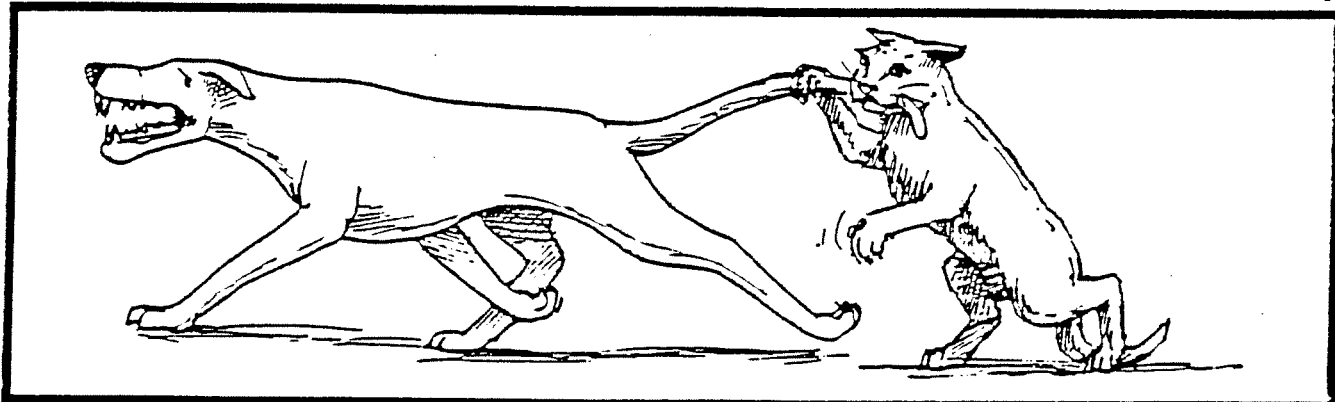

4

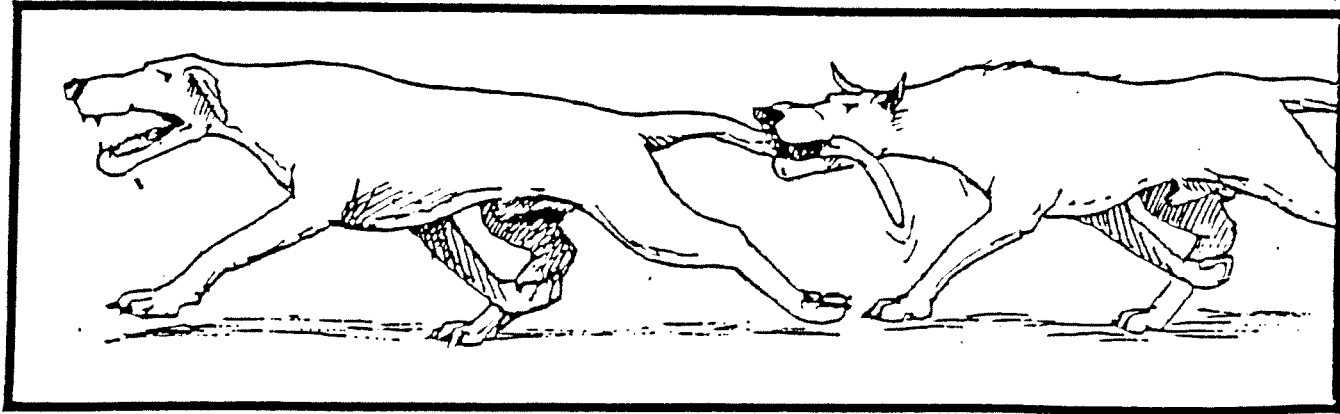

5

1

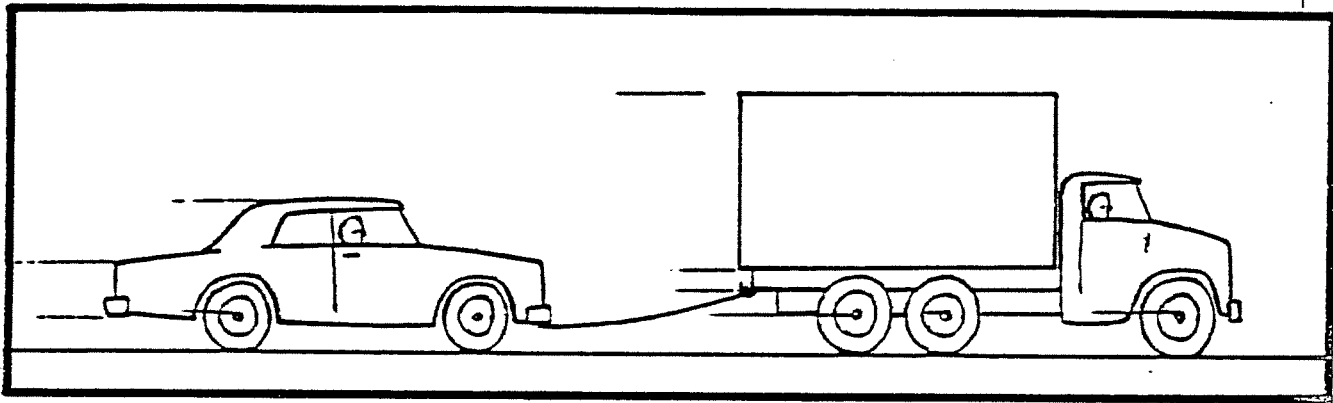

2

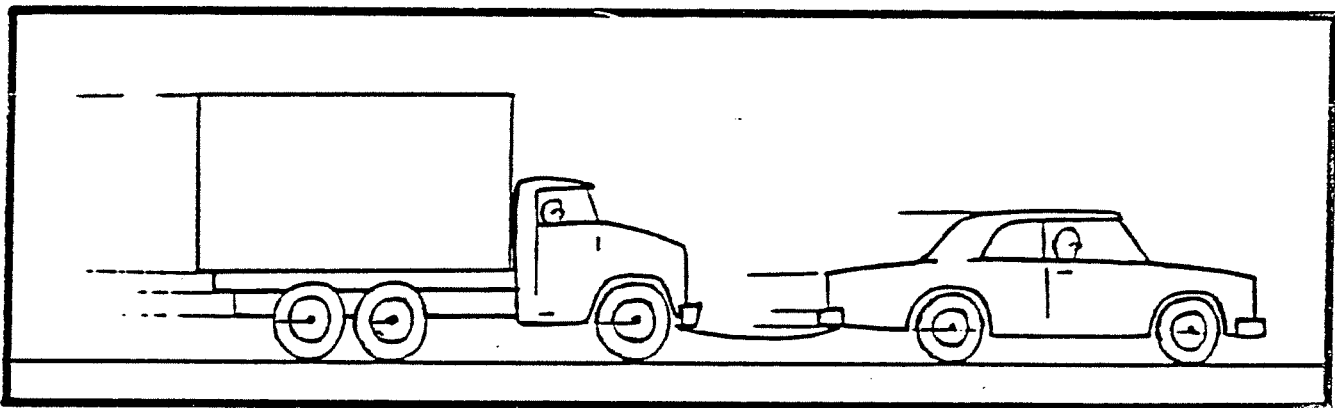

3

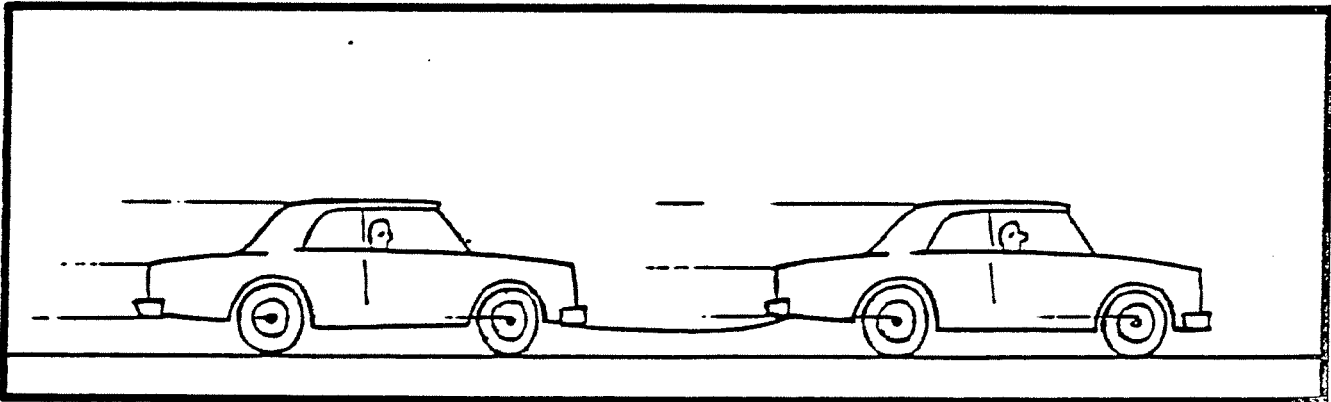

4

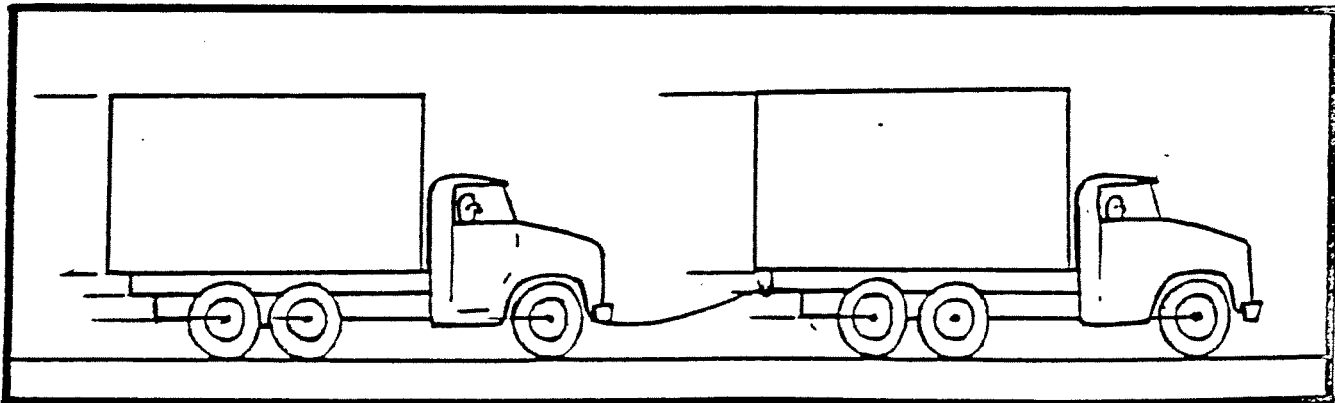

6

1

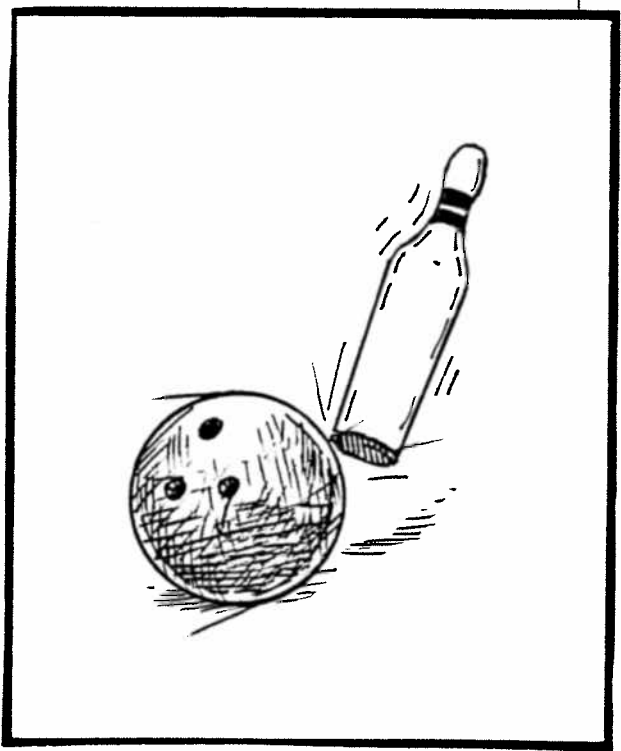

2

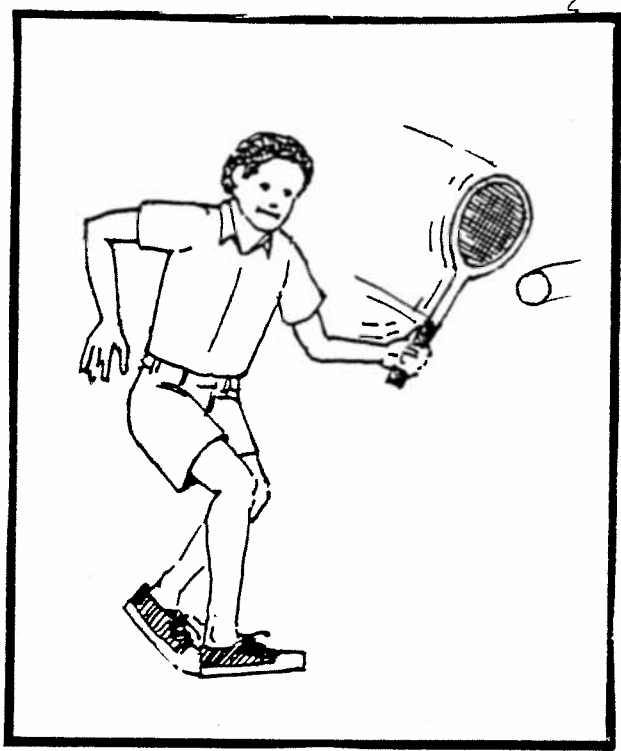

3

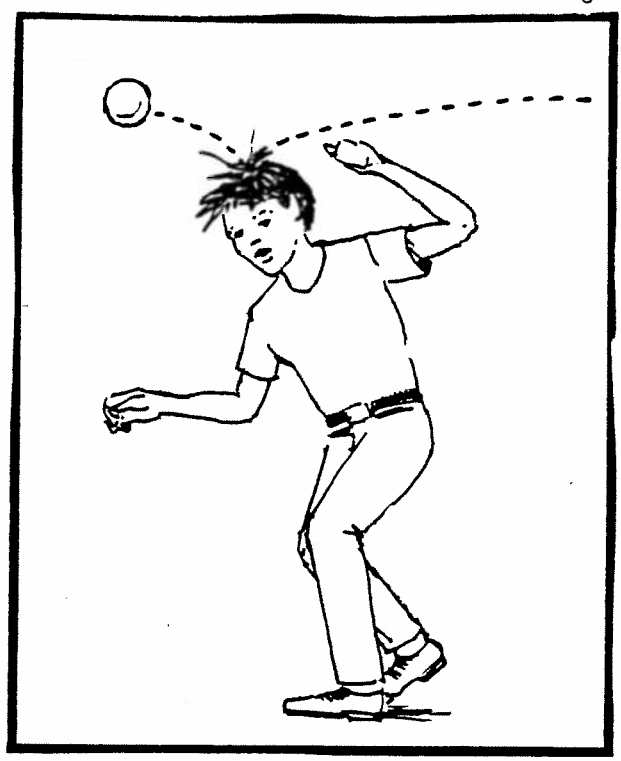

4

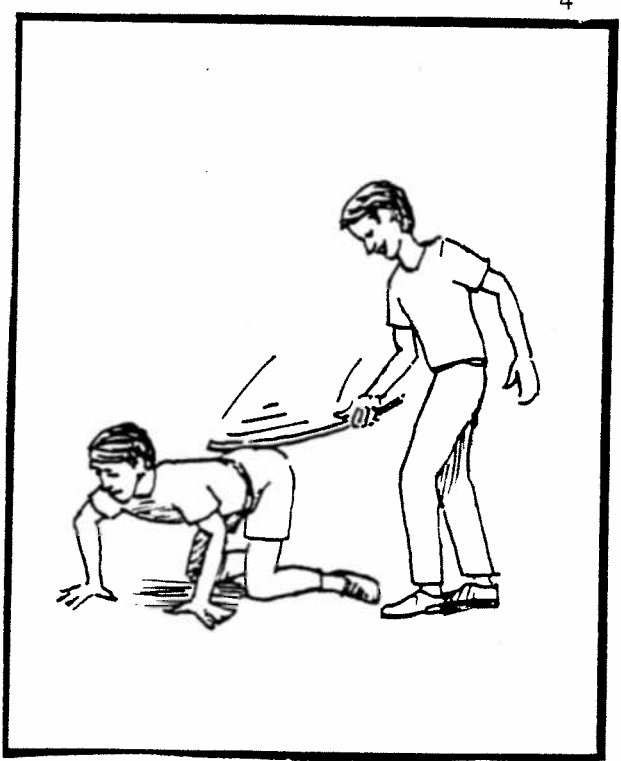

7

1



2



8

1

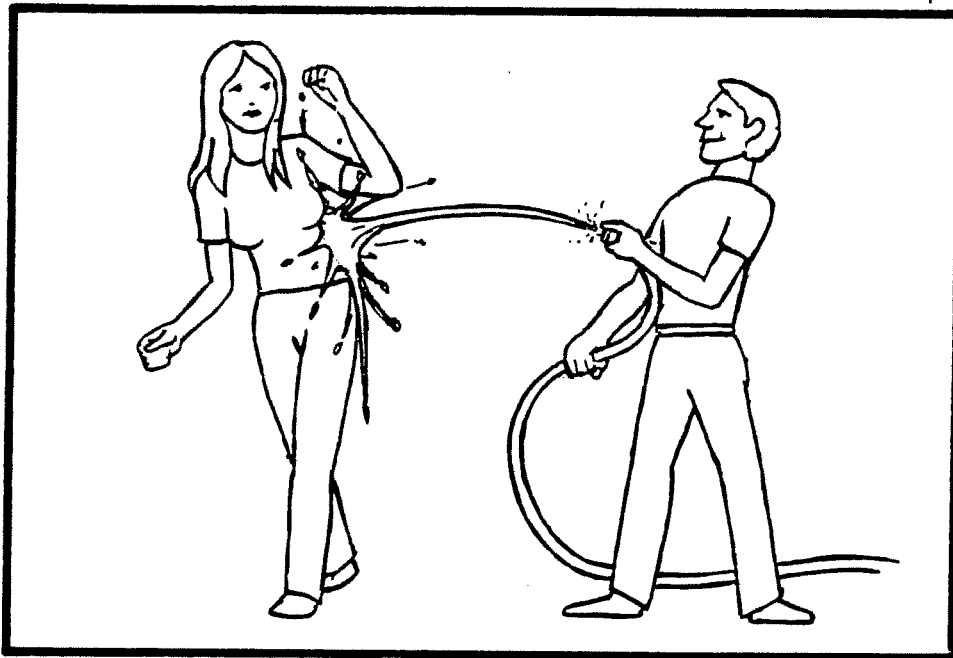

2

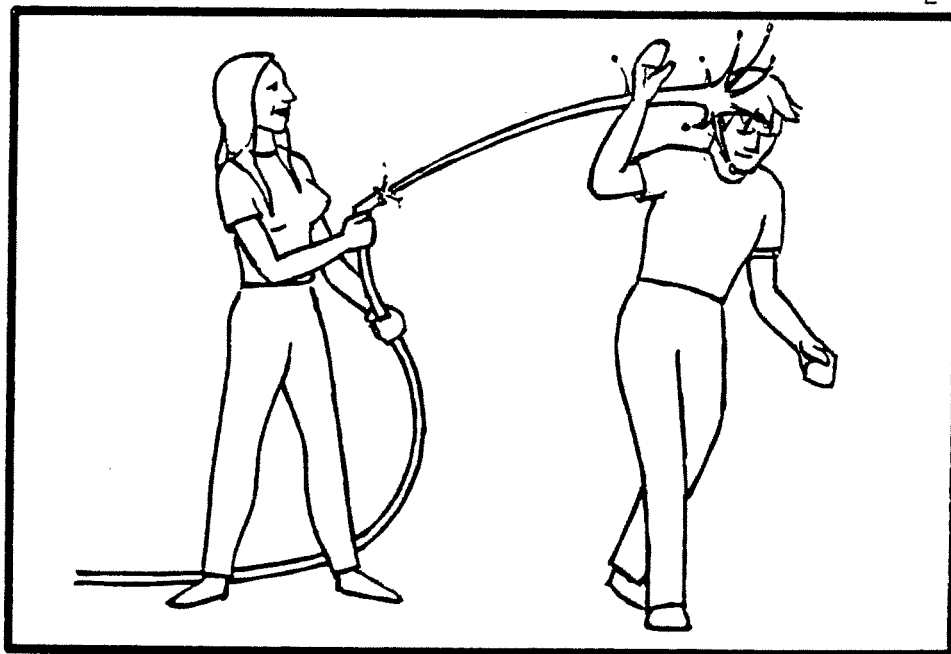

9

1

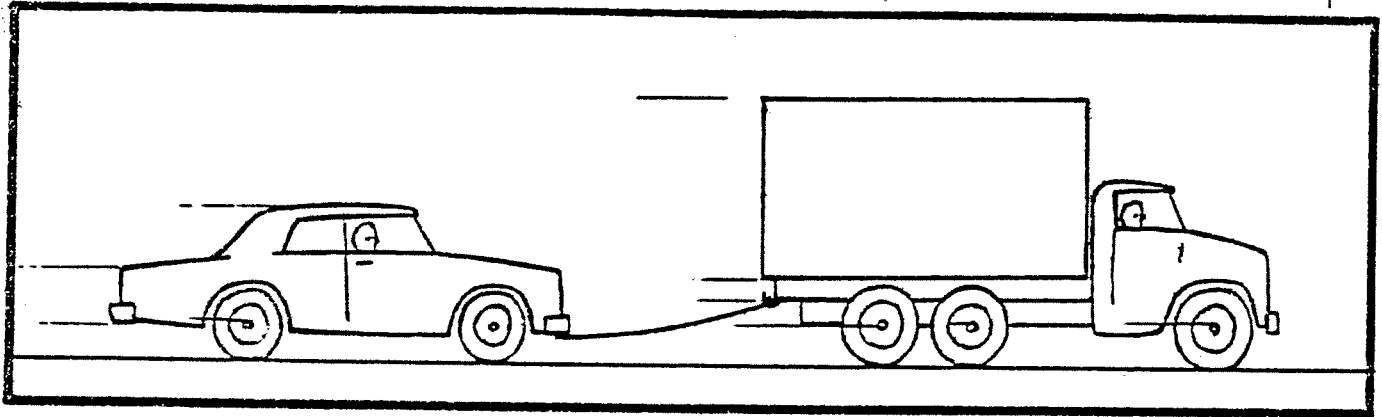

2

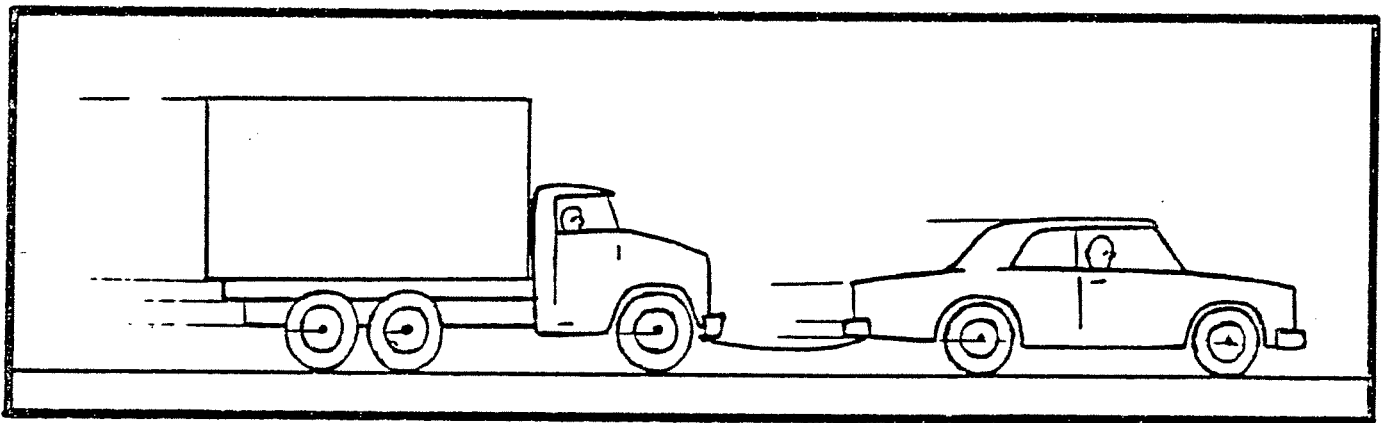

1



2

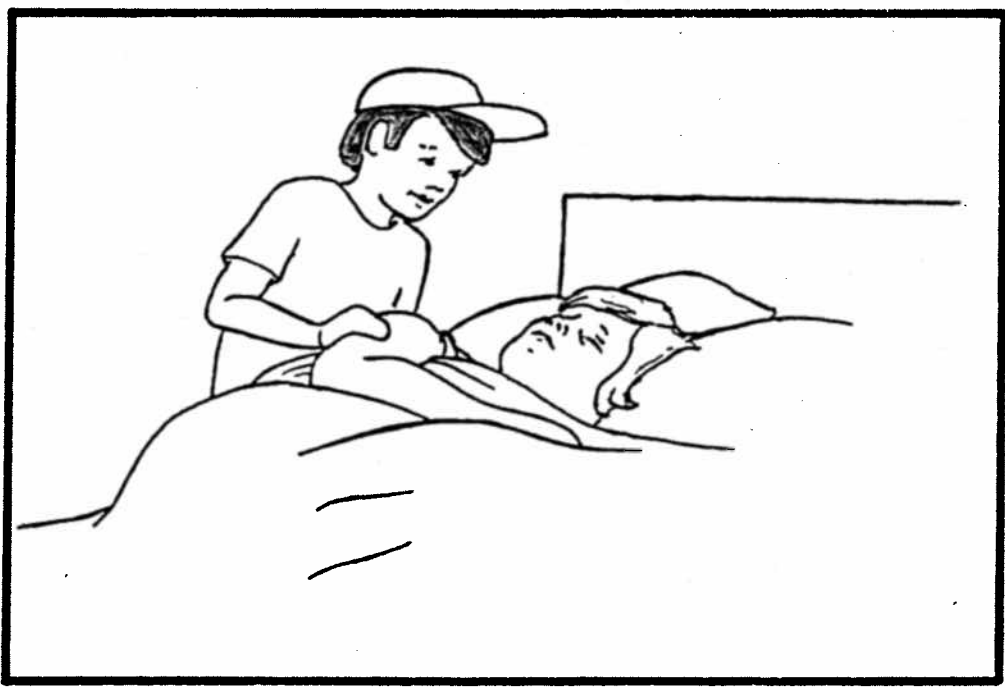

1

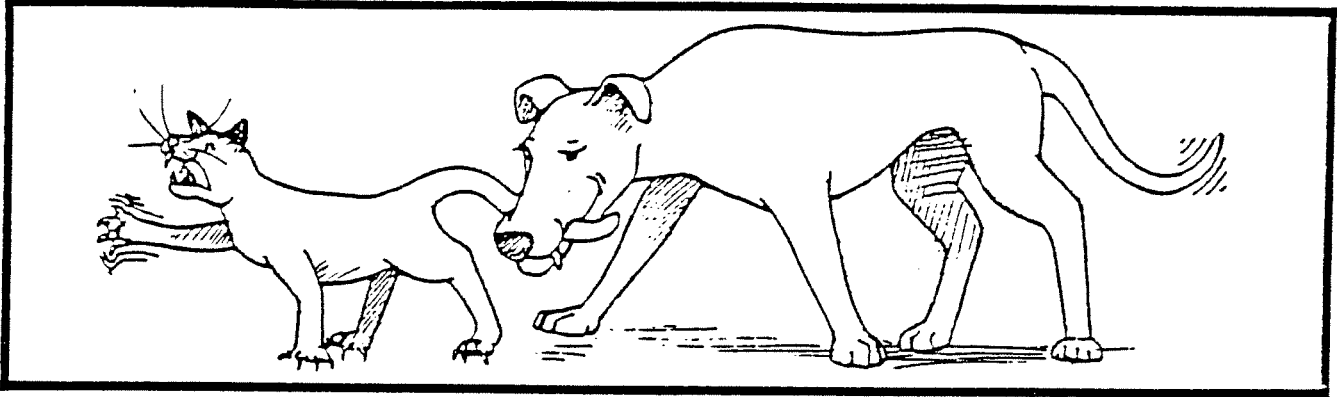

2

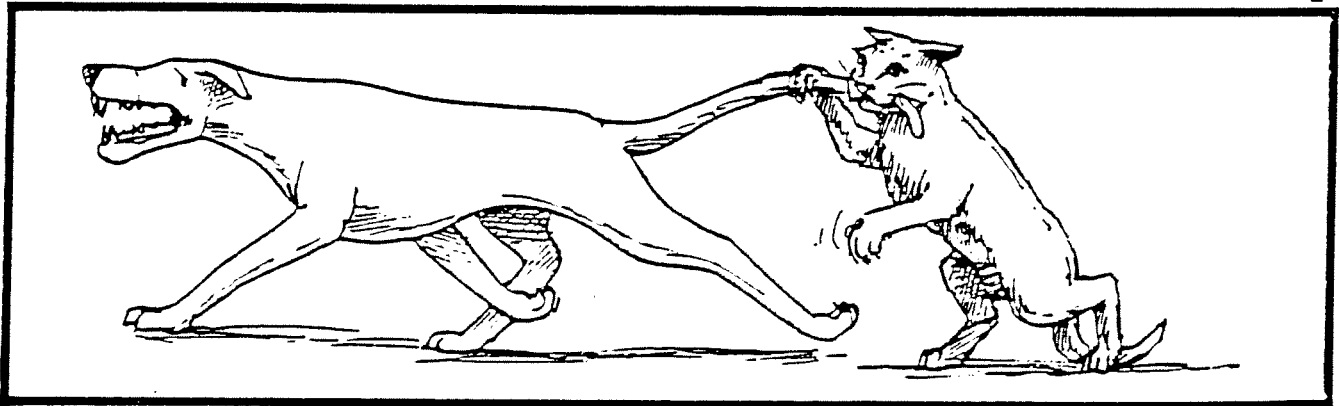



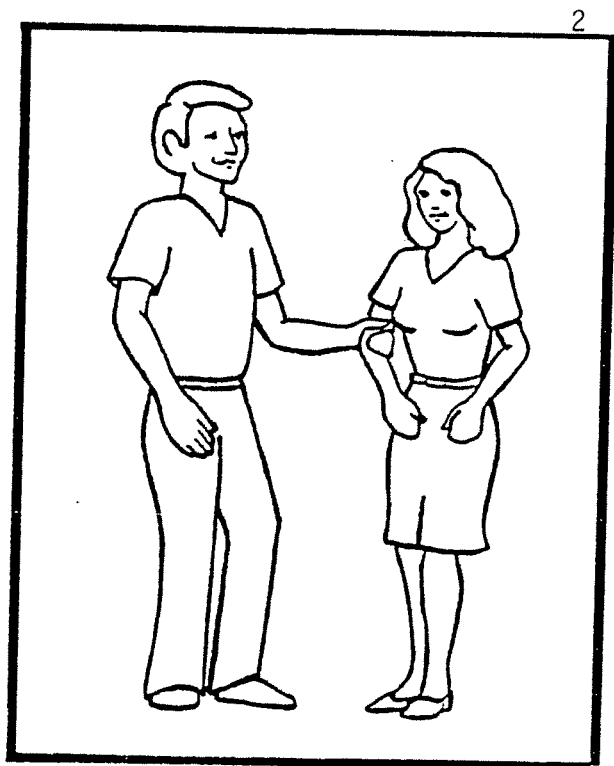
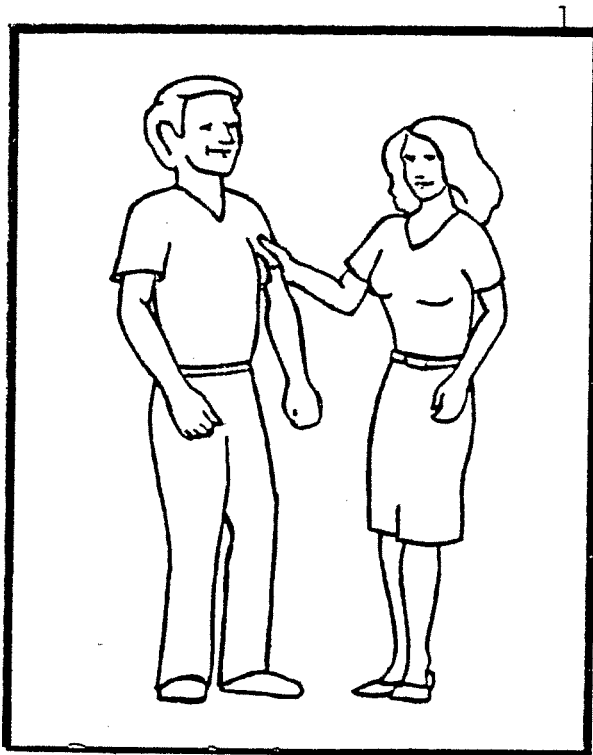

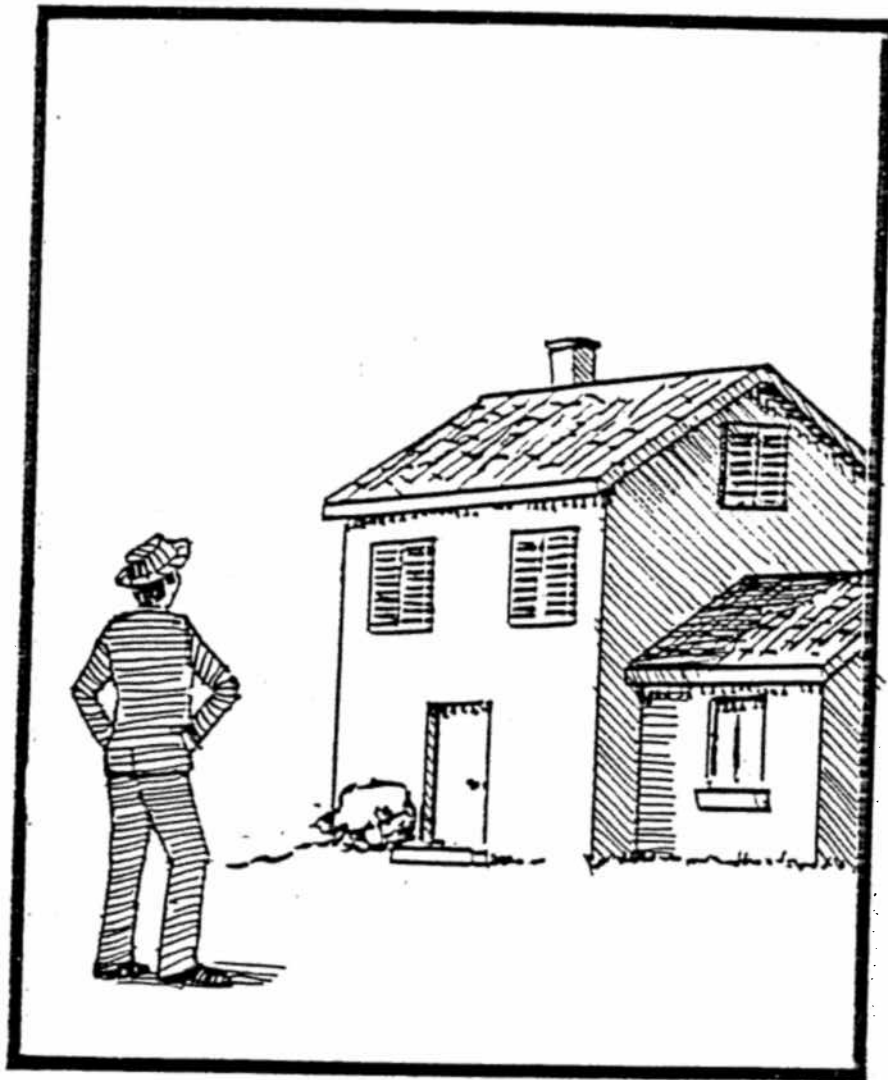

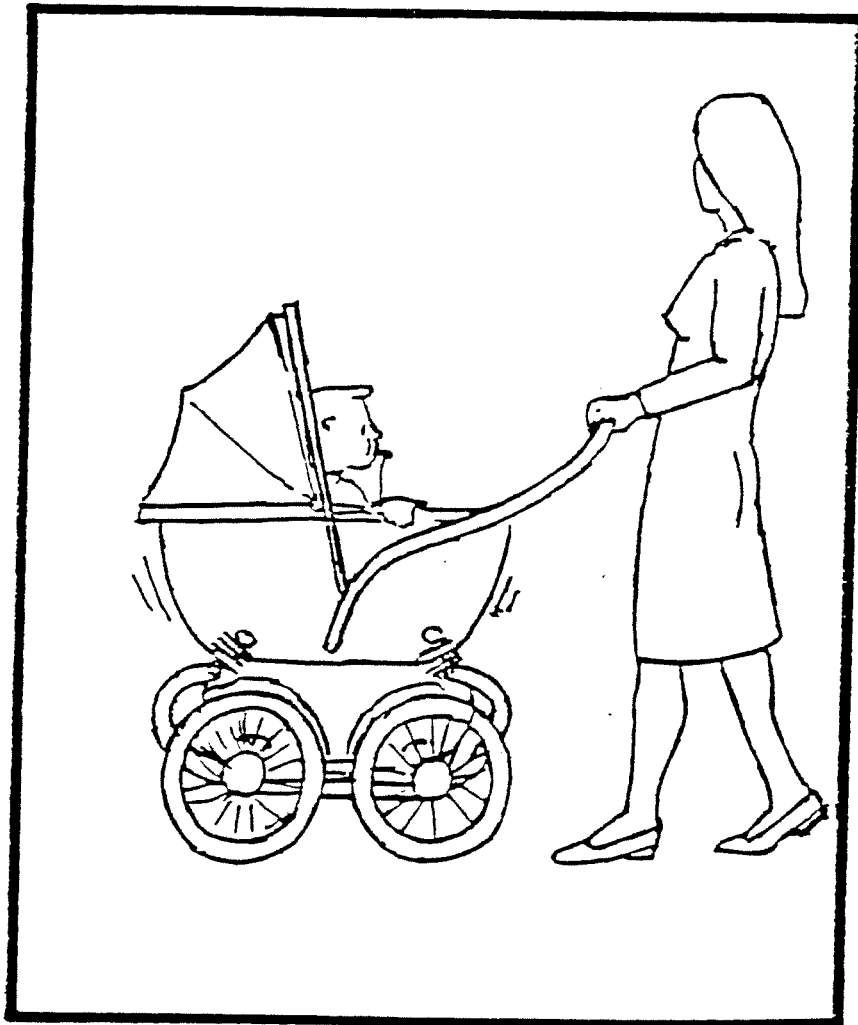

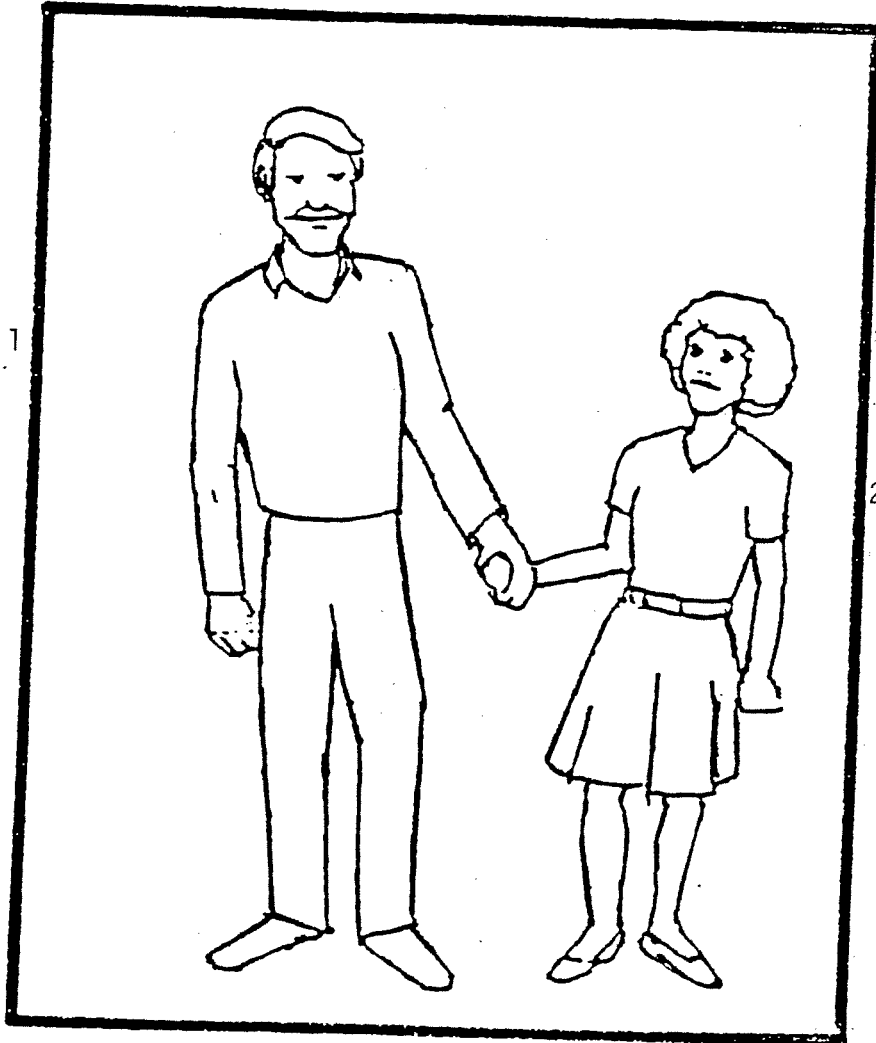

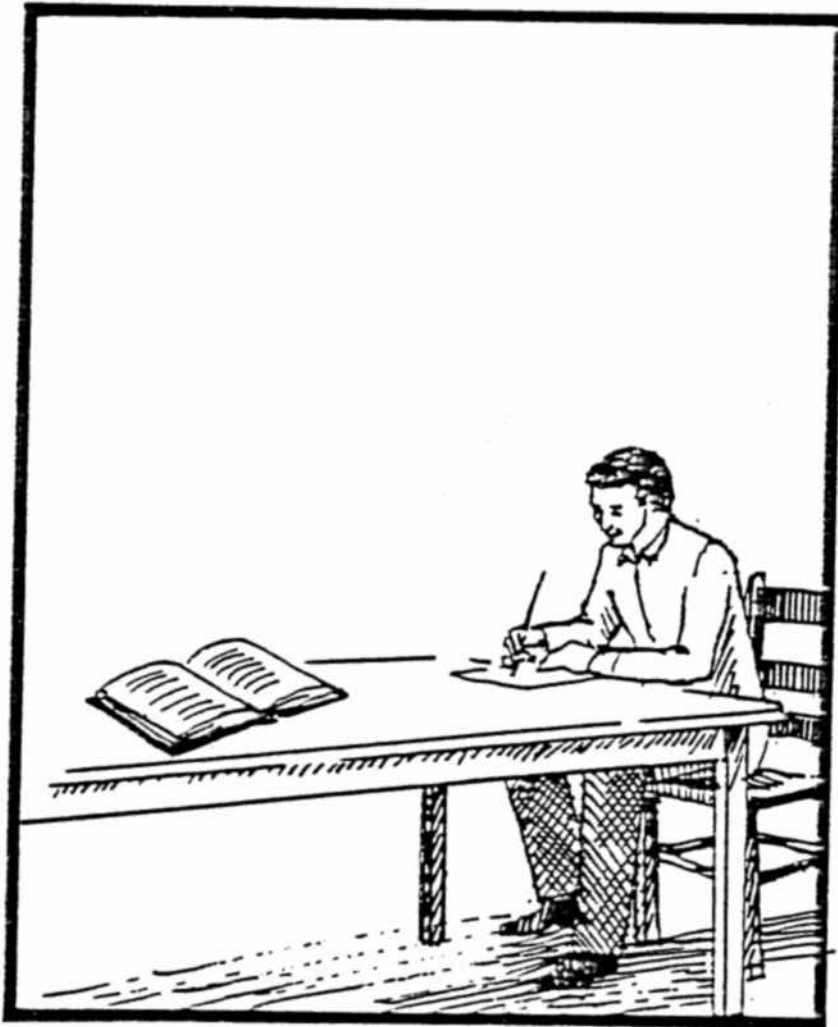

1

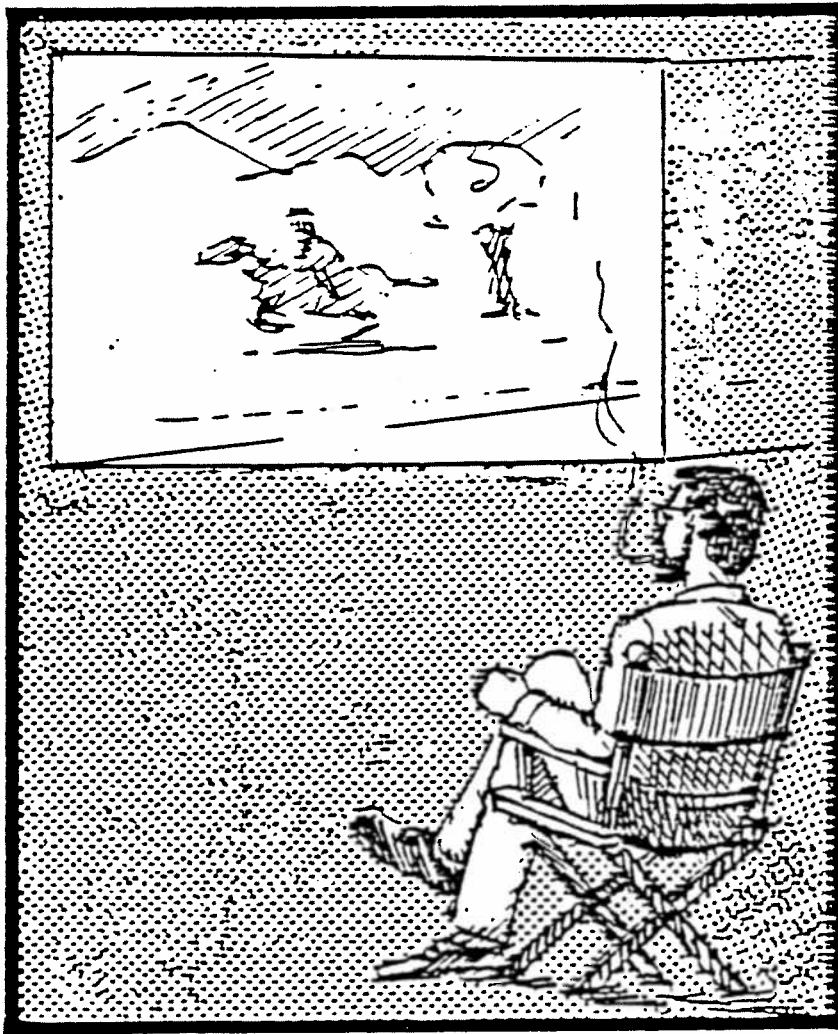

2



1

2

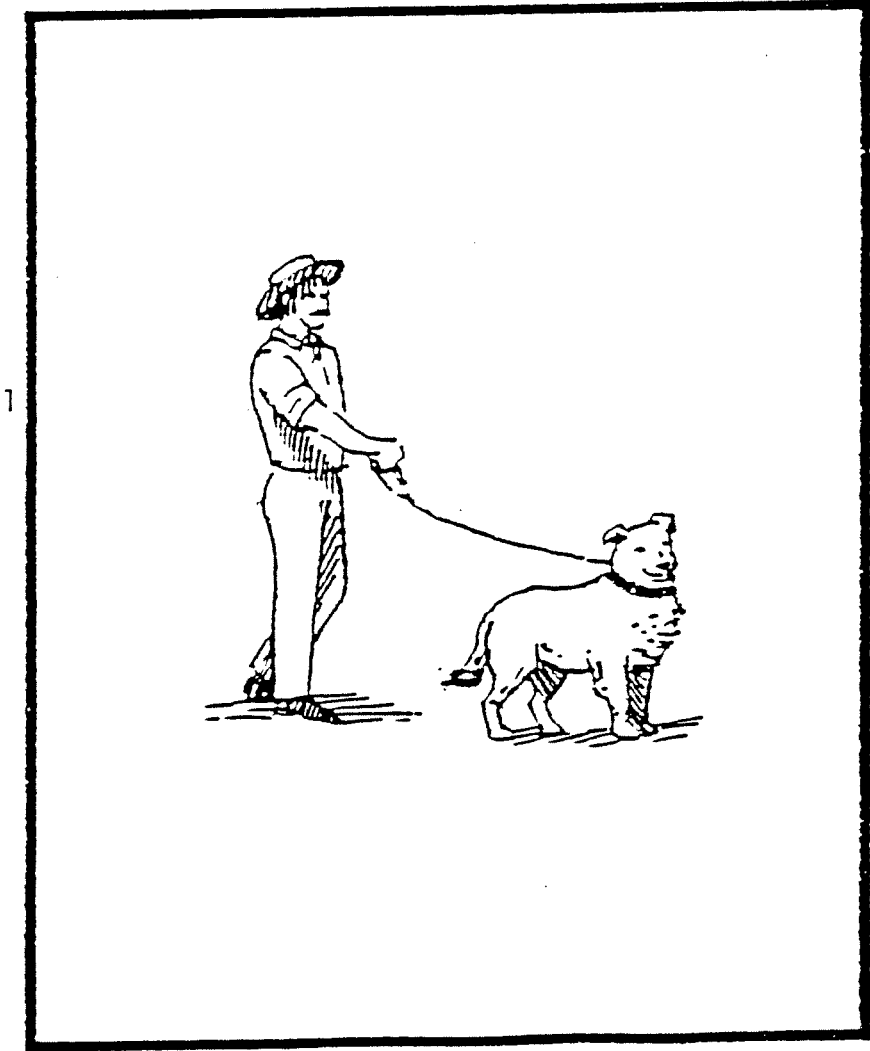

1

2



1



2

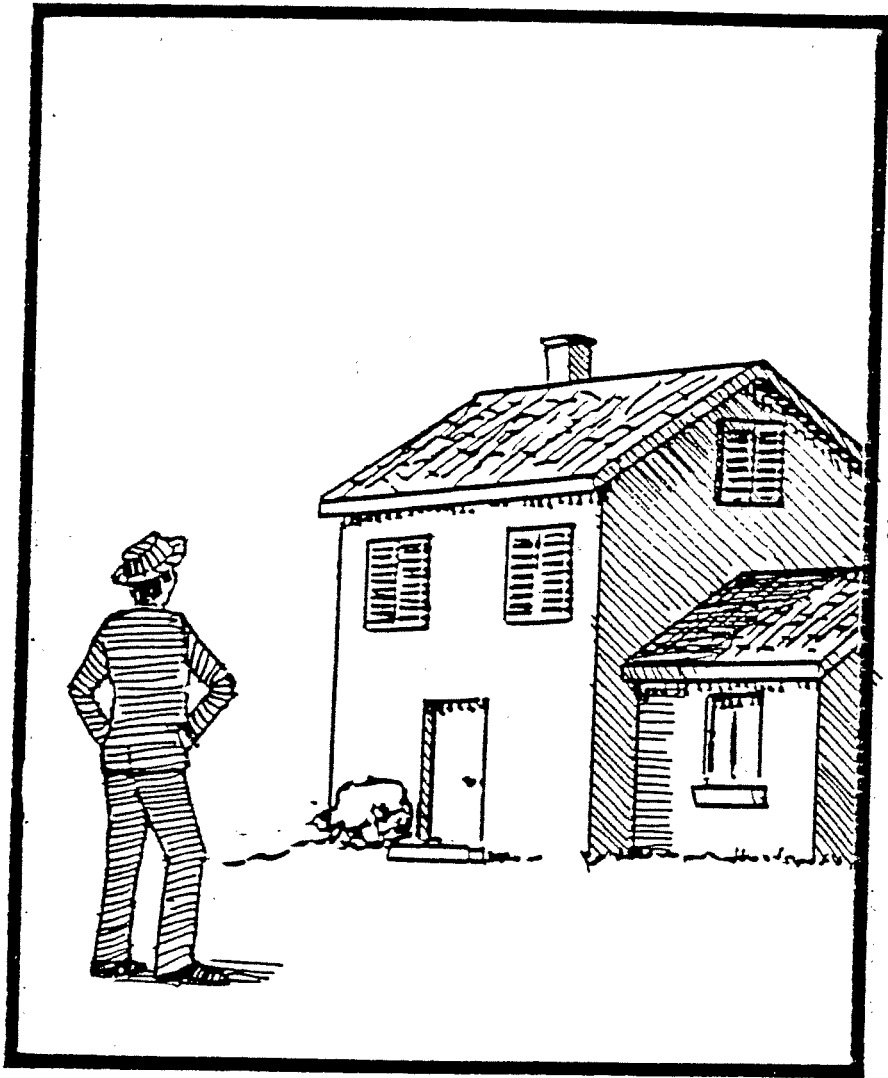

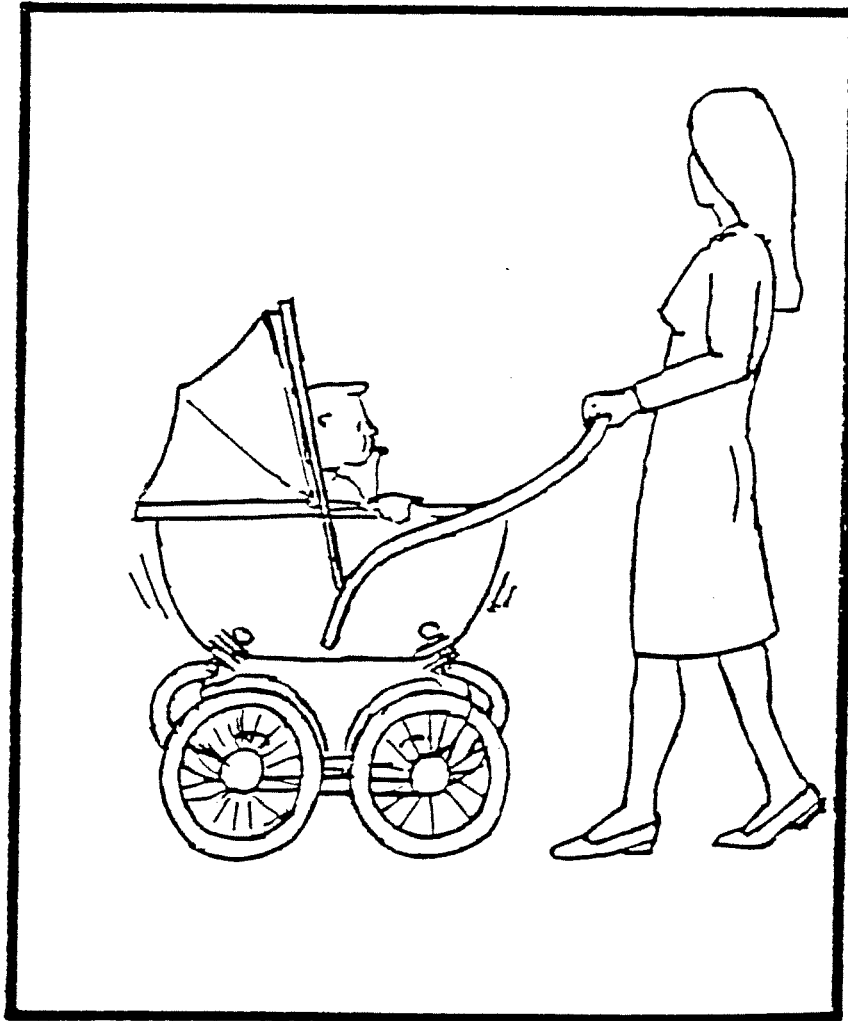

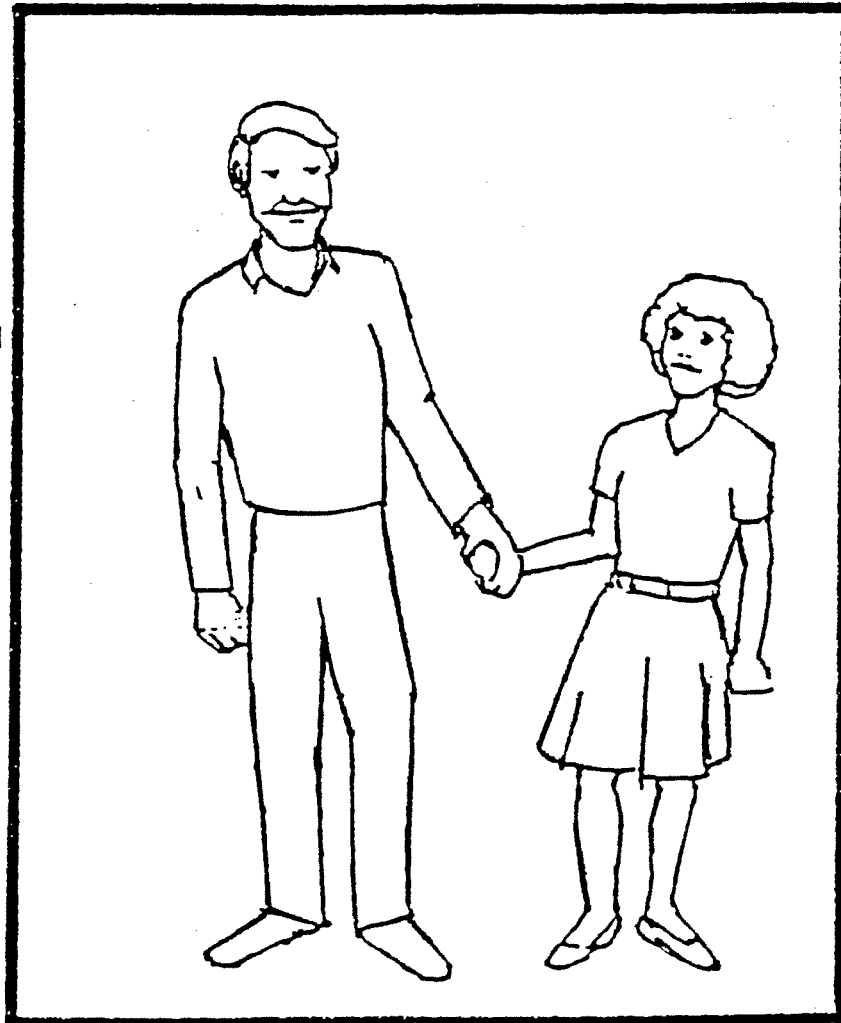

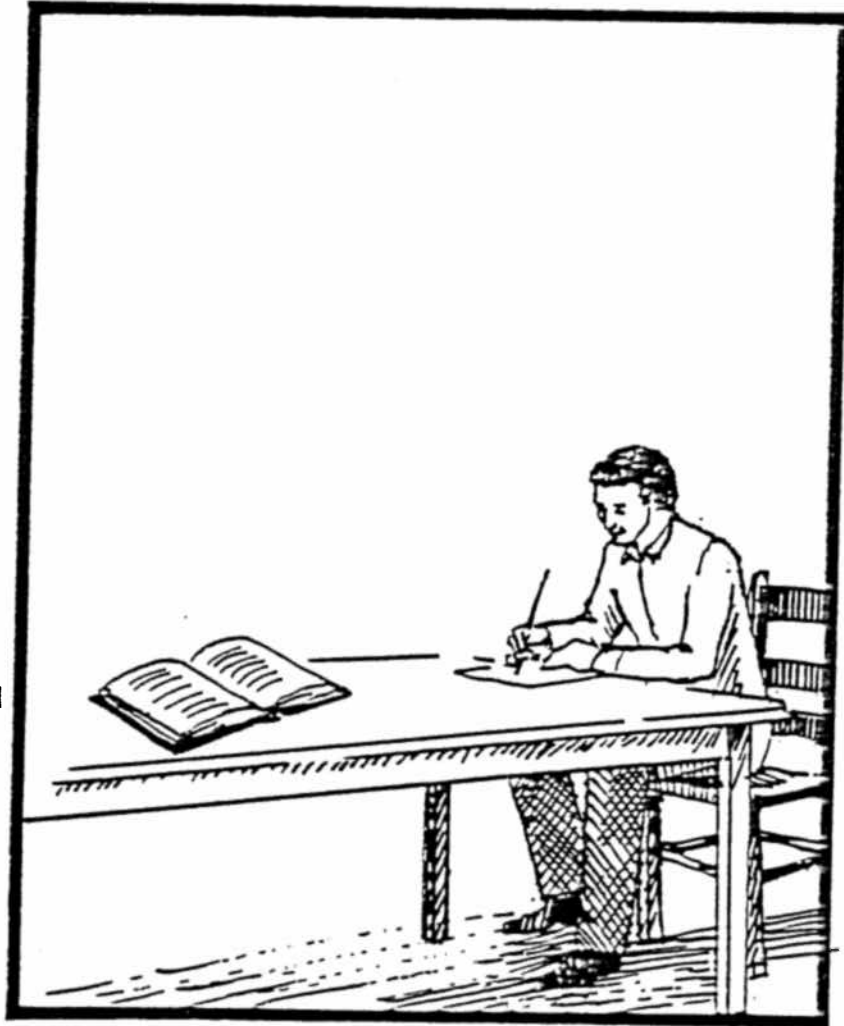

1

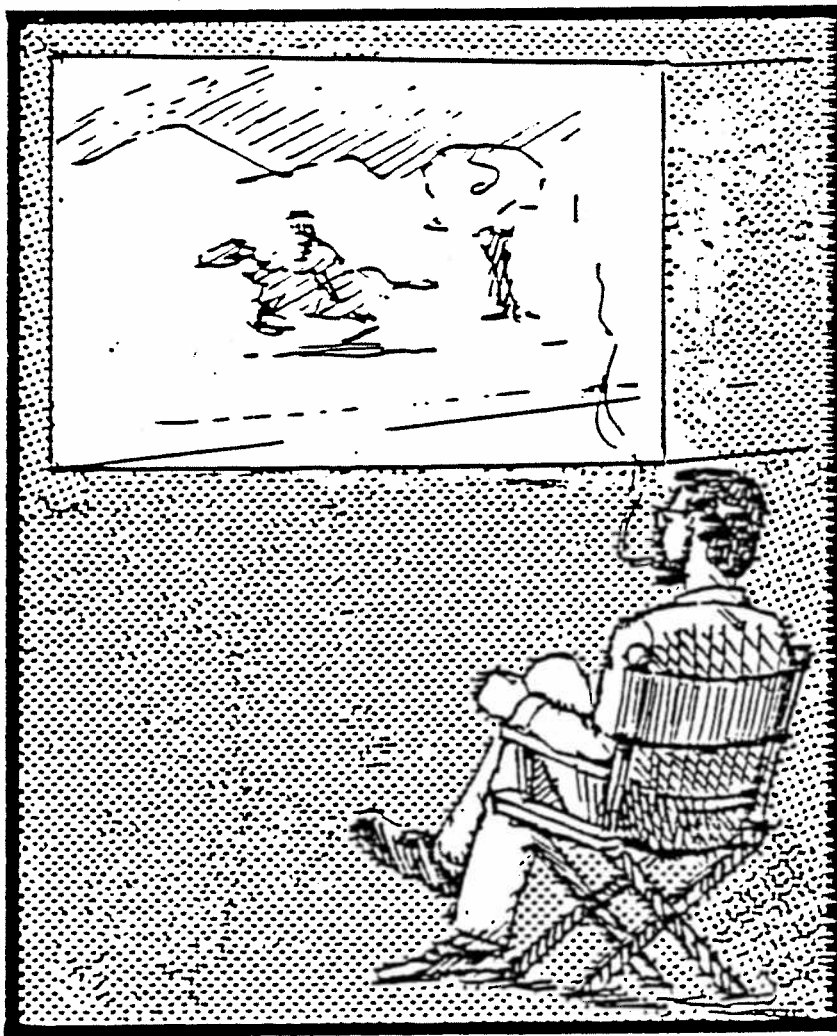

2

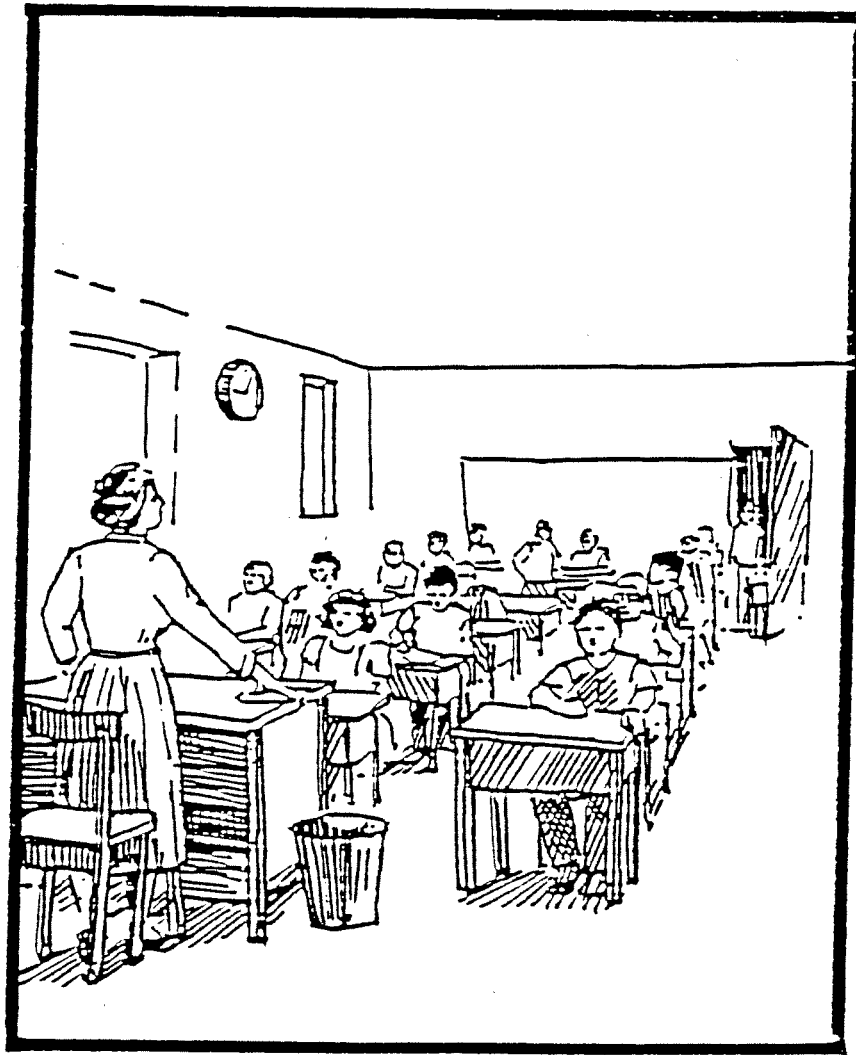

1

2

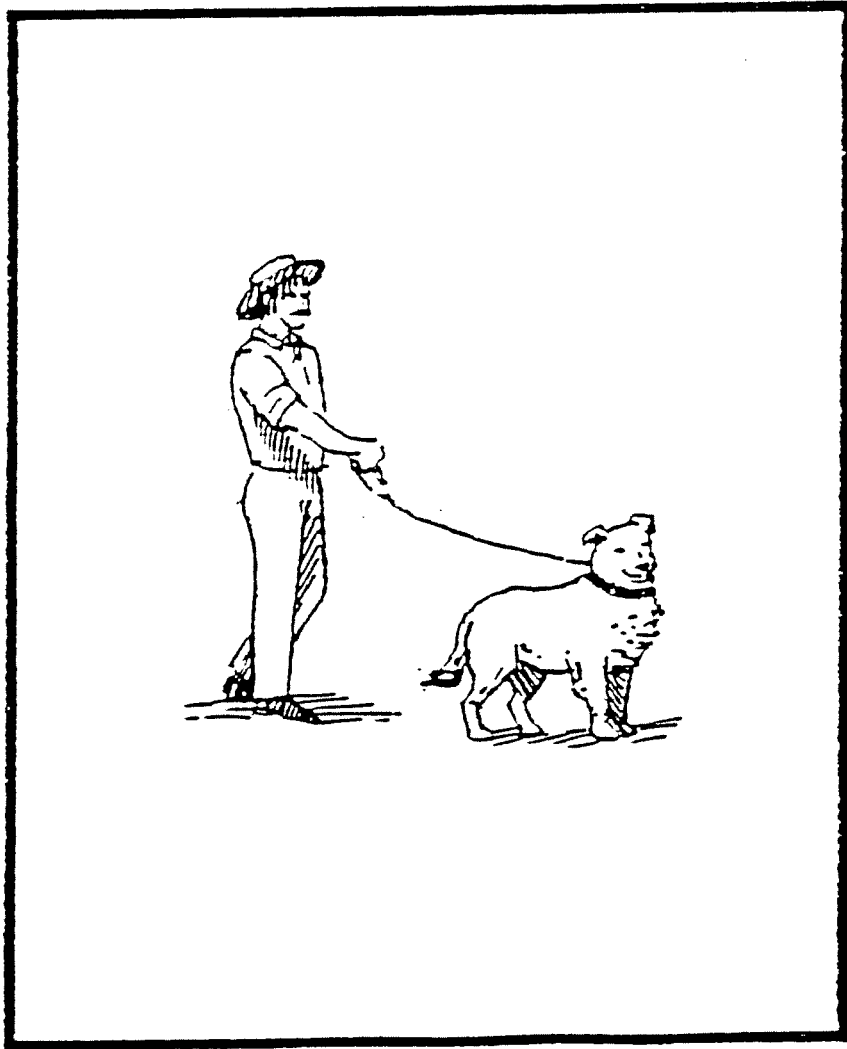

1

2







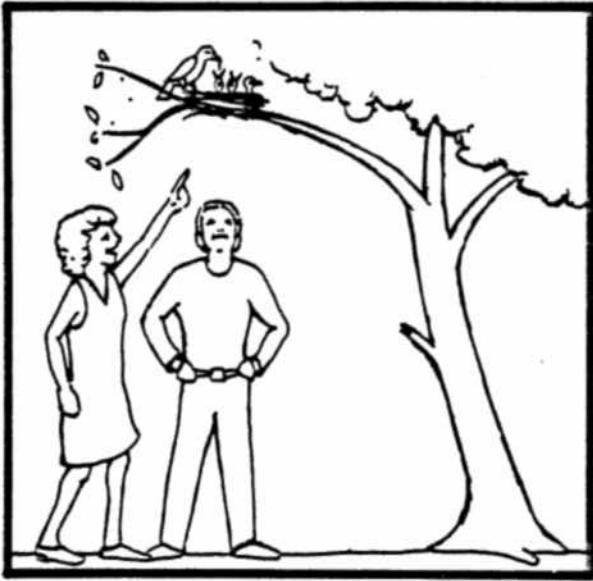

begy

szék

rák

róka

far

sánc

hó

nap

sör

nö

A leány fogja a seprüt.

Ö húzza öt.

A kutyát megharapja a macska.

Az autó megy neki a teherautónak.

A csónak nem húzza a fiút.

A teherautó nem megy neki az autónak.



A kutyát harapja meg a macska.

Ö fogja öt.

A fiút a csónak húzza.

A fiút nem üti meg a labda.

Egy asszony elment a kisfiával a piacra. Vett két malacot. Amint hazaértek a falujukba, az asszony elment a szomszédjához, és elcserélte a malacokat egy borjúra.

pék

meggy

tar

sánc

csap

## SZÓOLVASÁS ÉS KÉPEGYEZTETÉS

begy

1

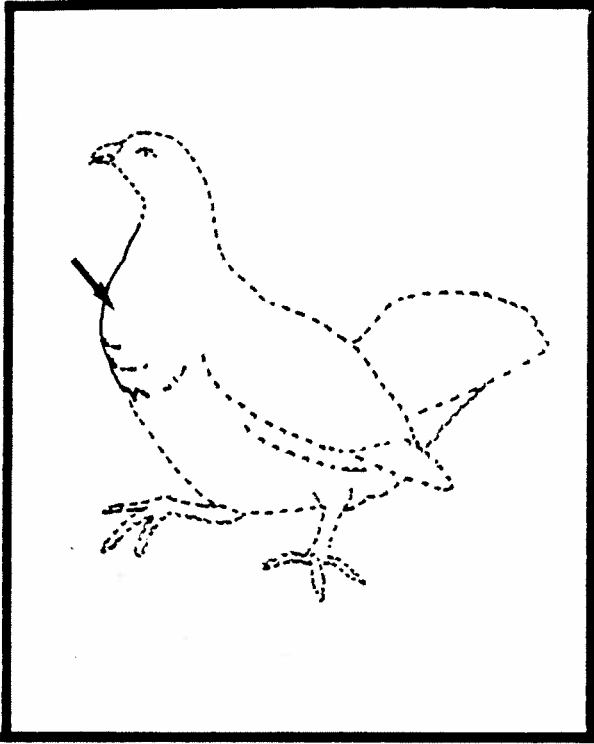

2



3

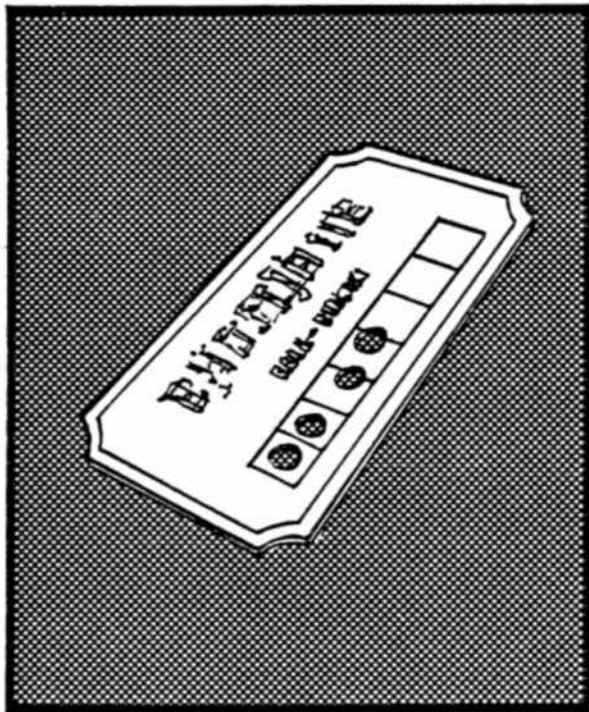

4

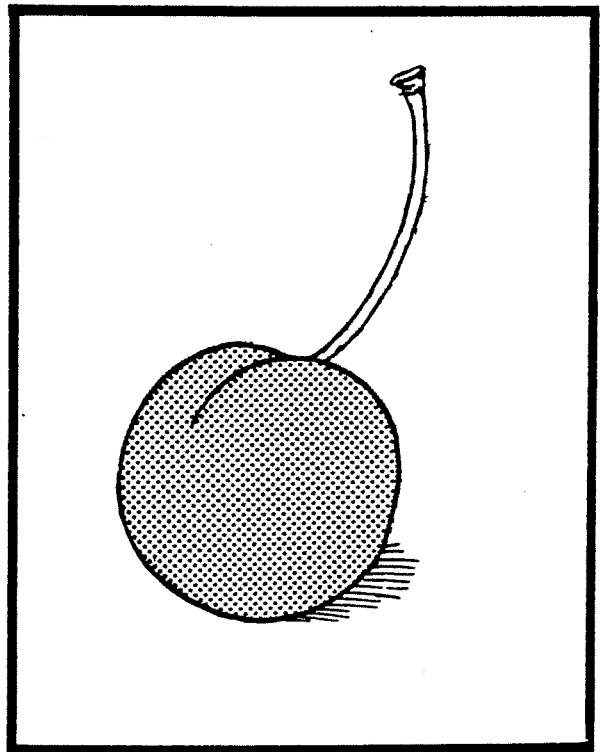

szék



1

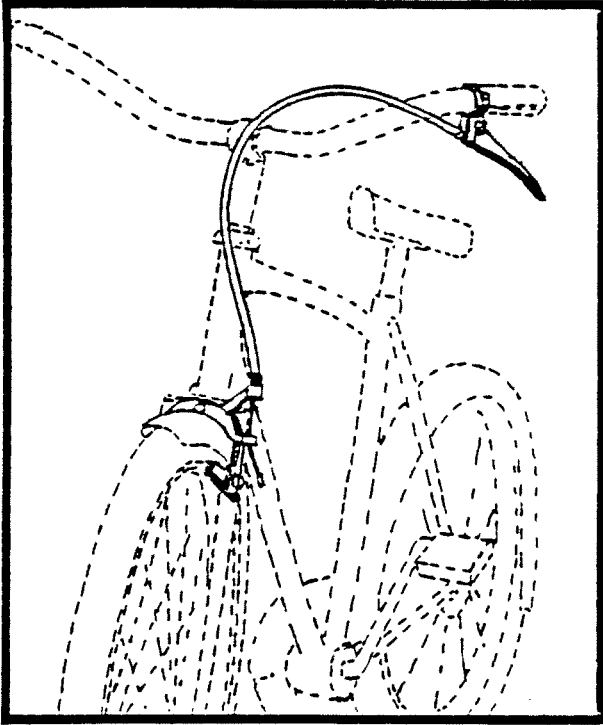

2

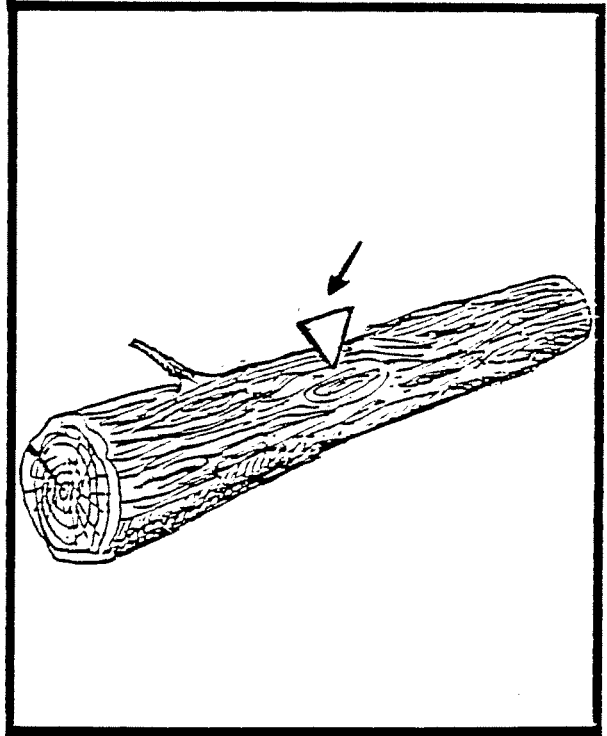

3



4

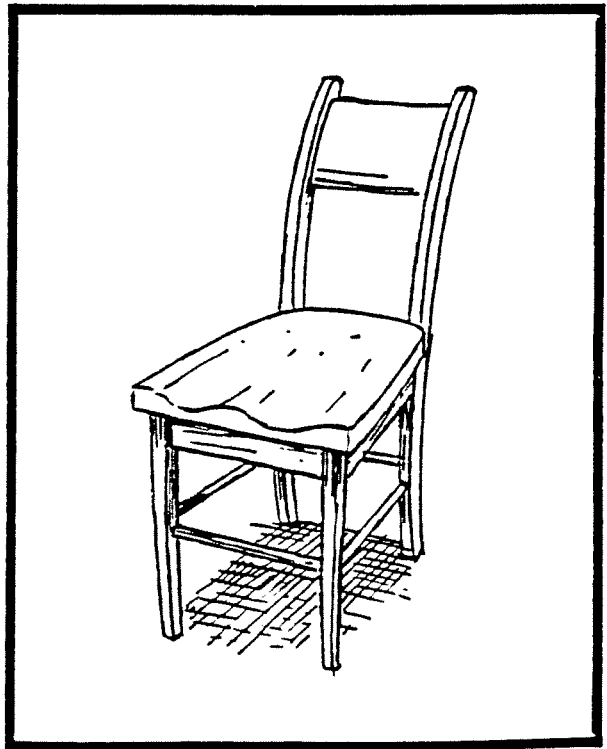

rák

1

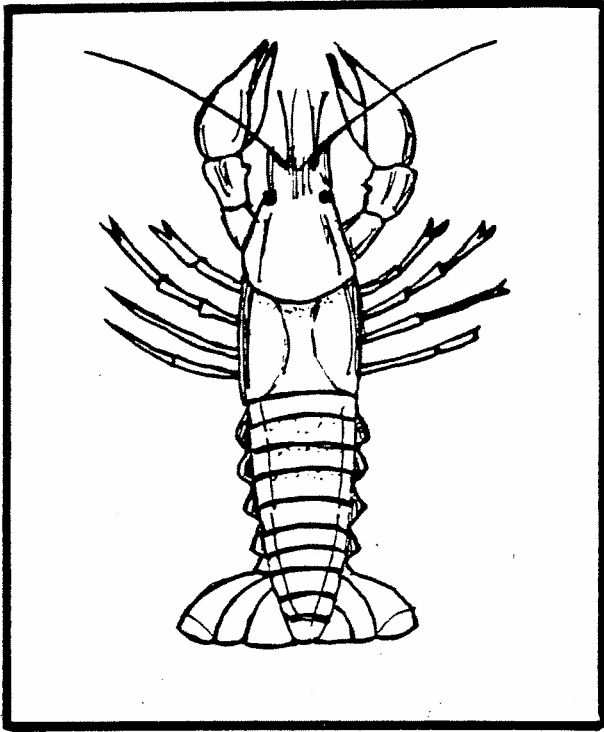

2

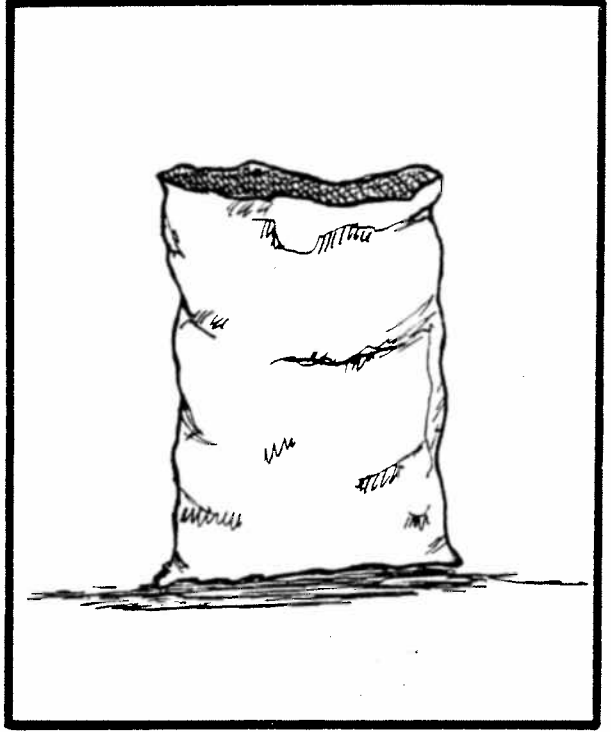

3

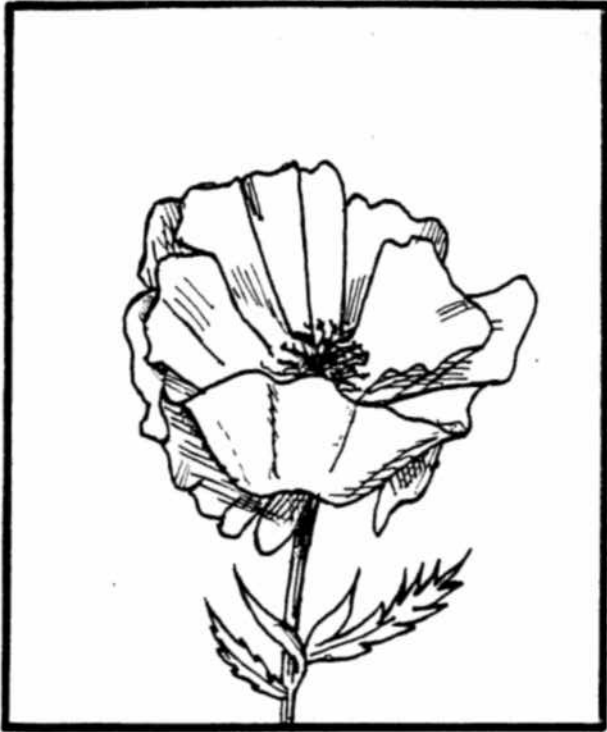

4

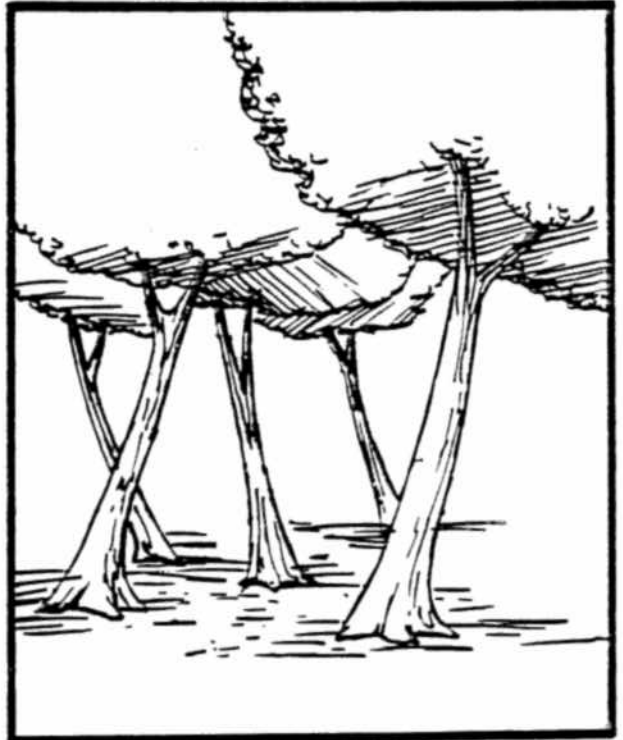

róka

1

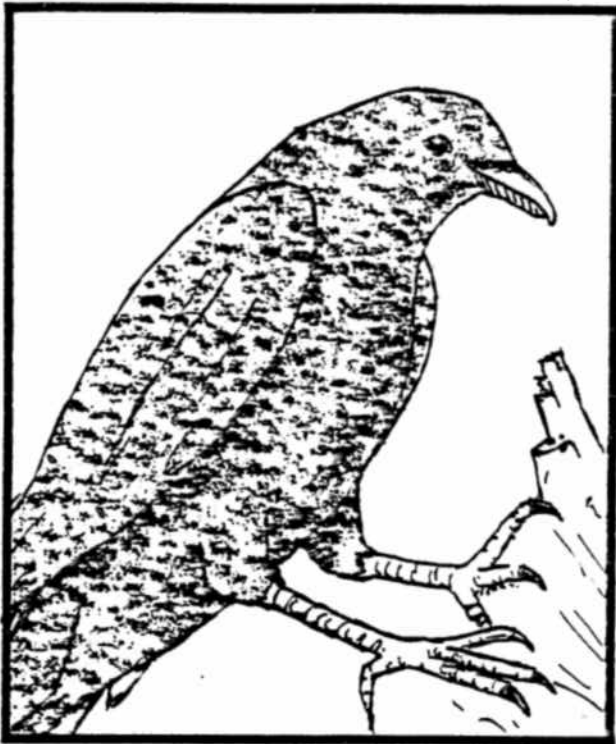

2

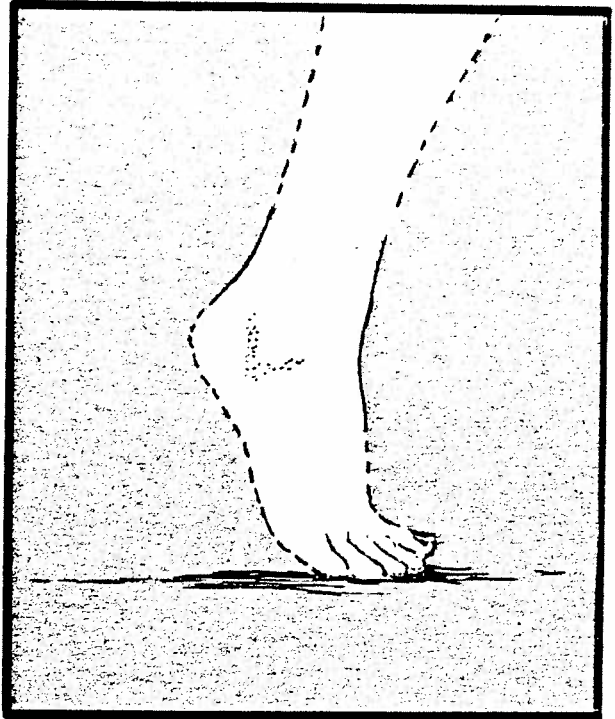

3

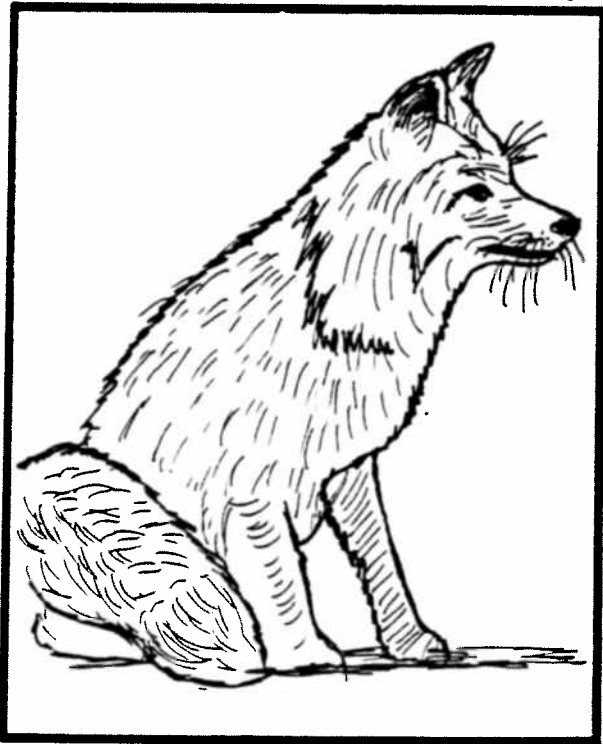

4

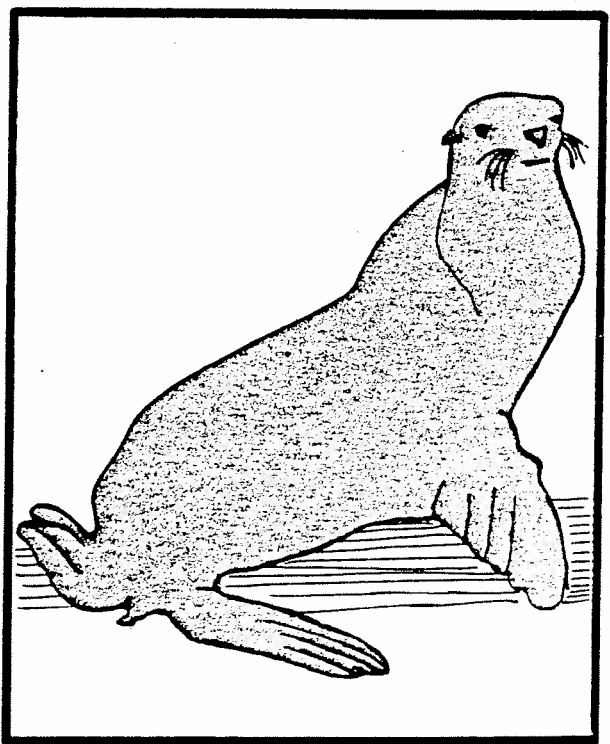

far

1

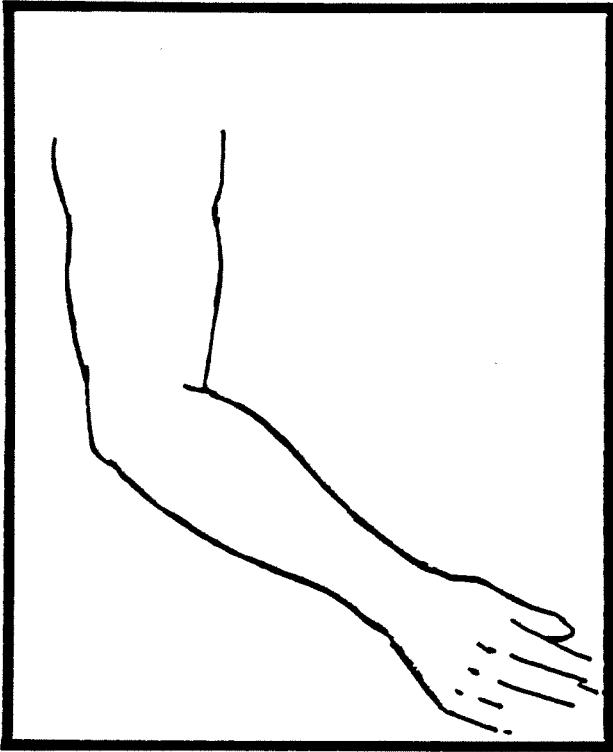

2

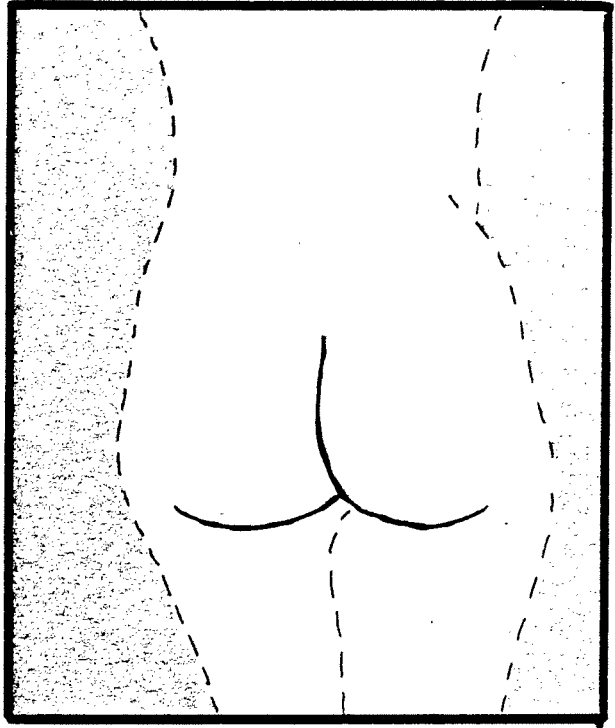

3

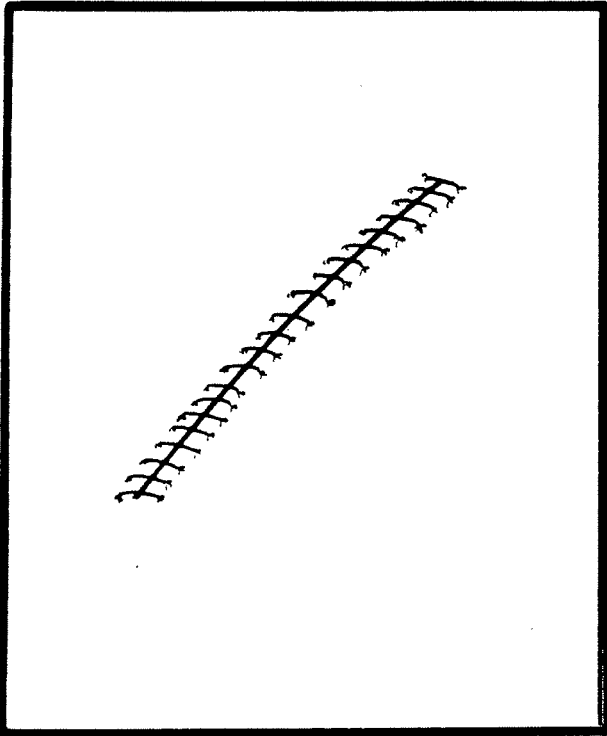

4

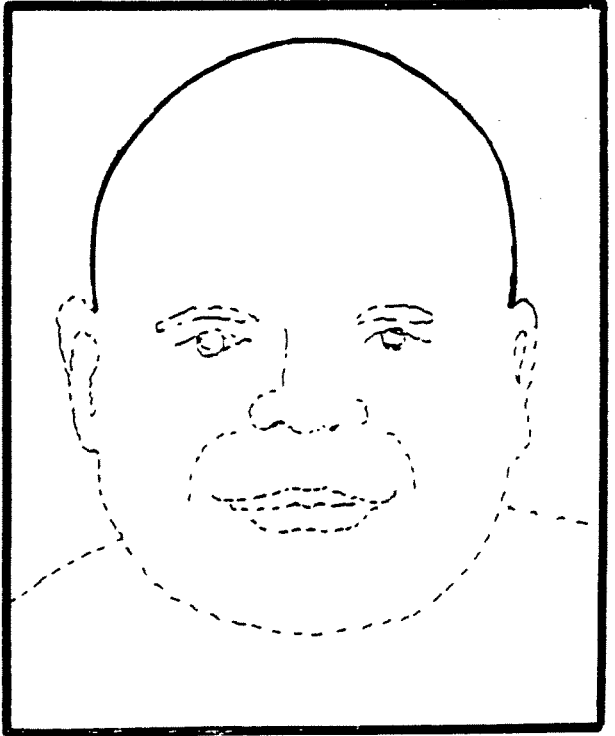

sánc



1

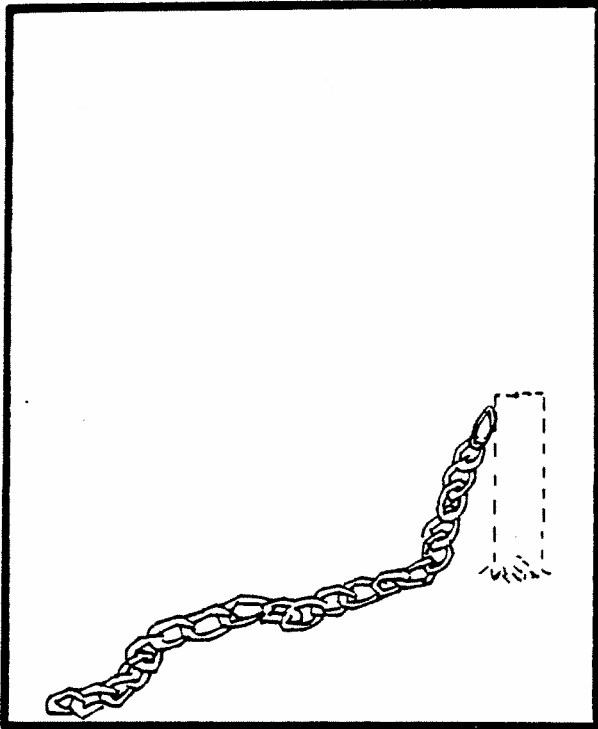

2

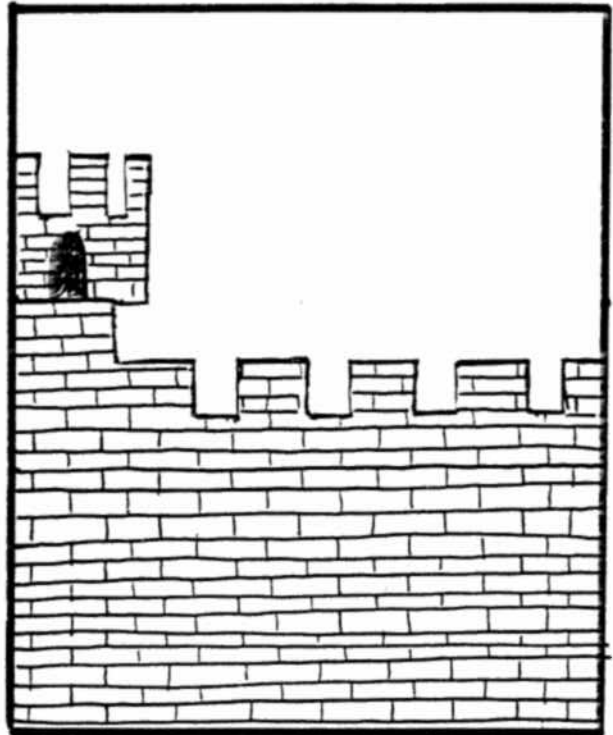

3

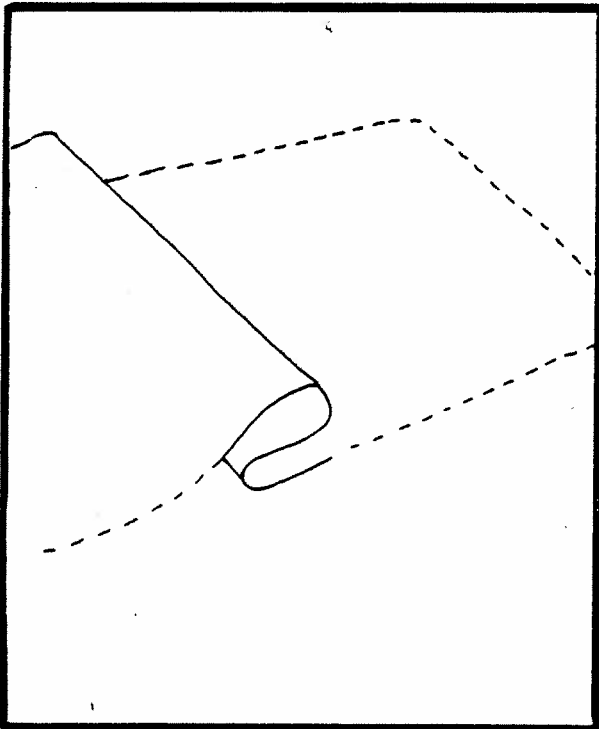

4



hó

1

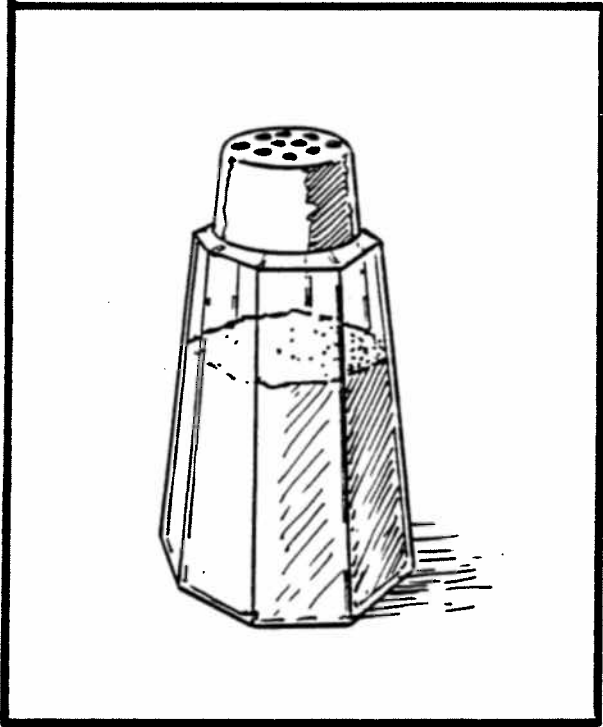

2

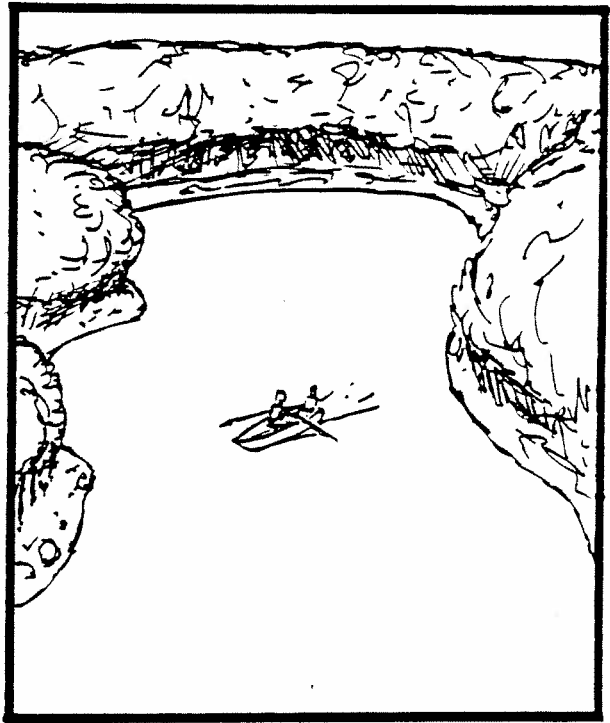

3



4

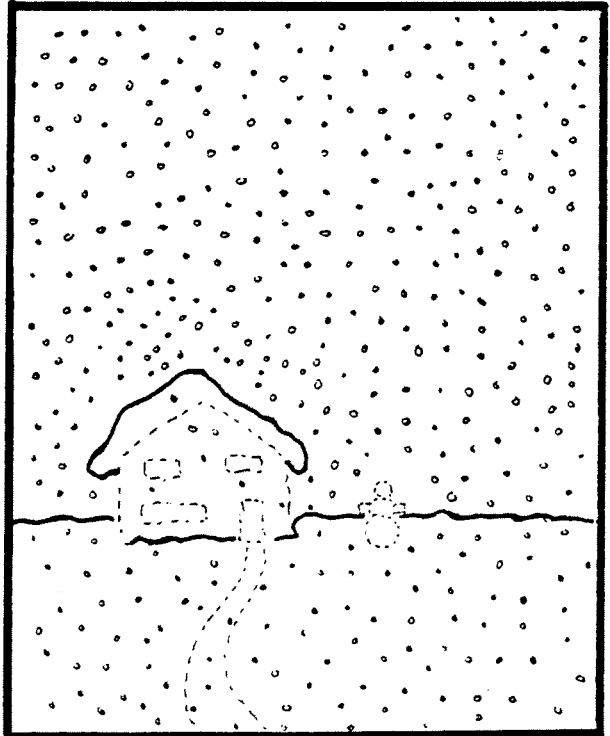

nap

1

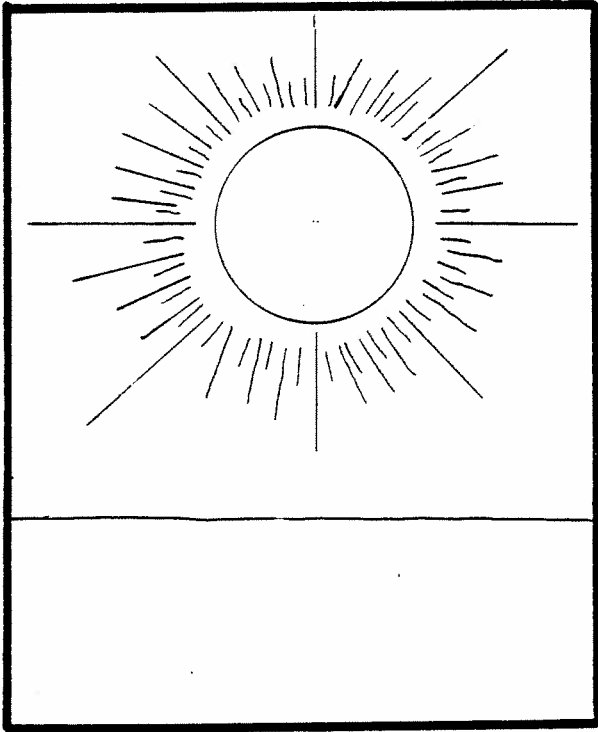

2

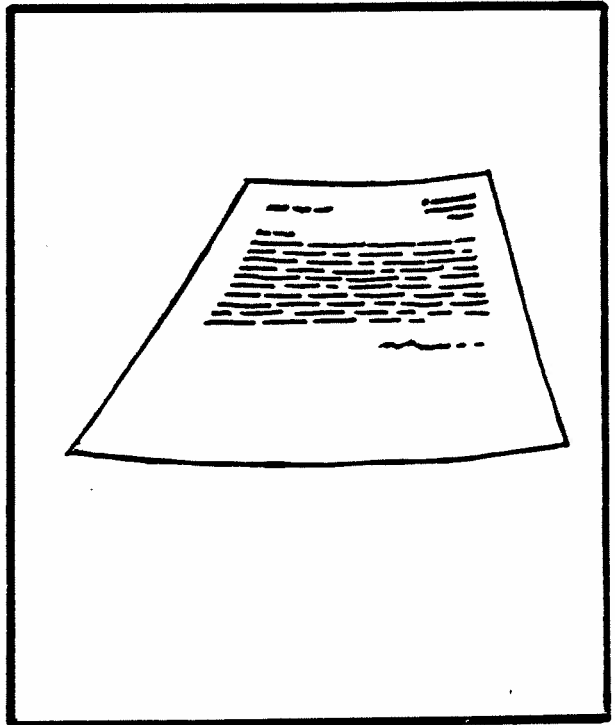

3

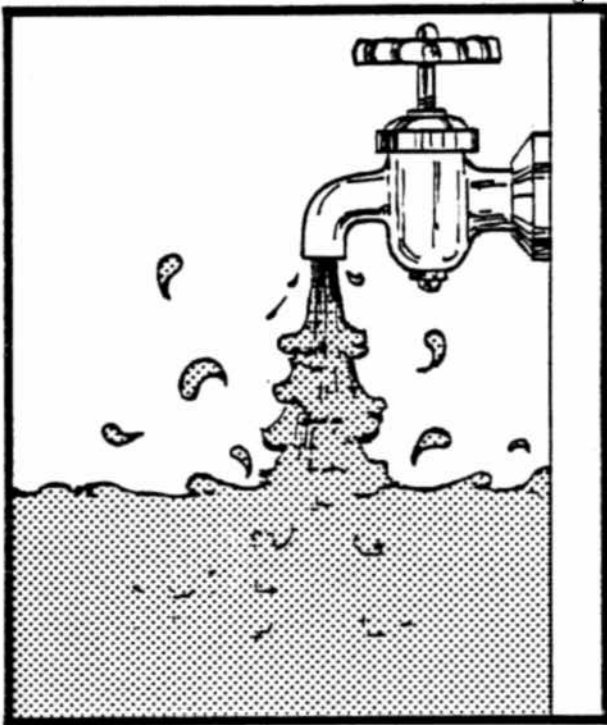

4

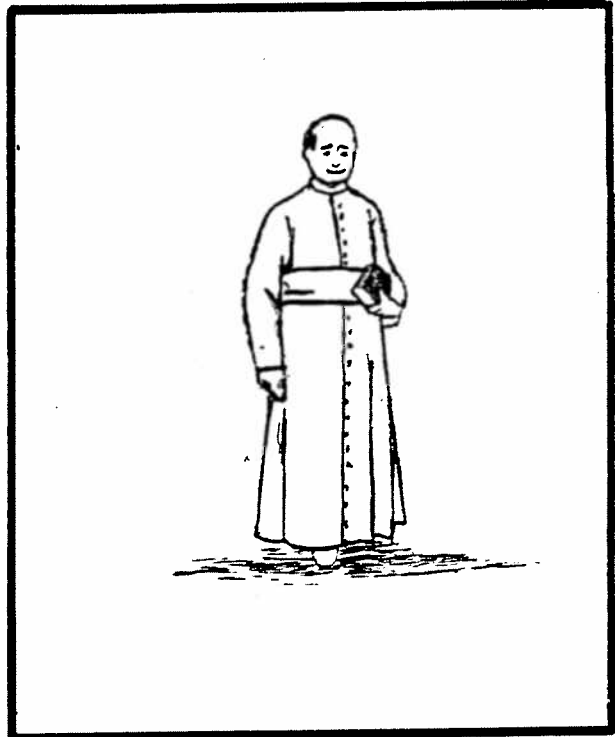

sör

1

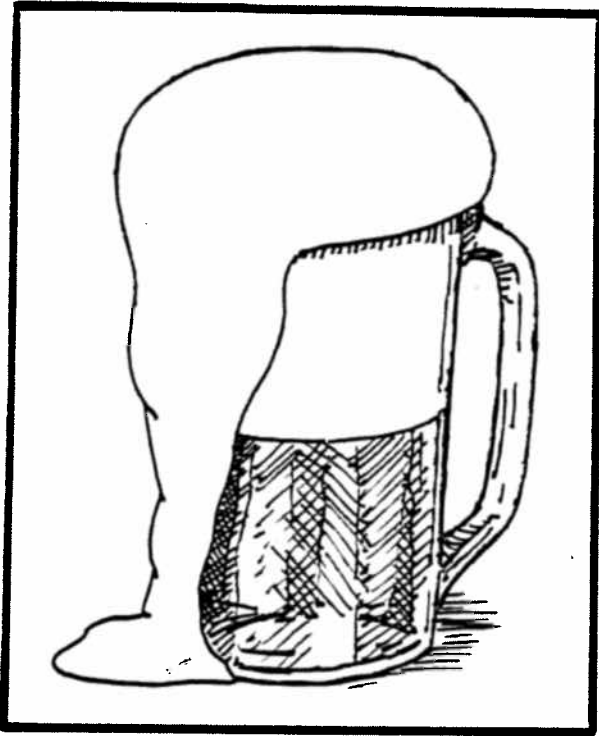

2

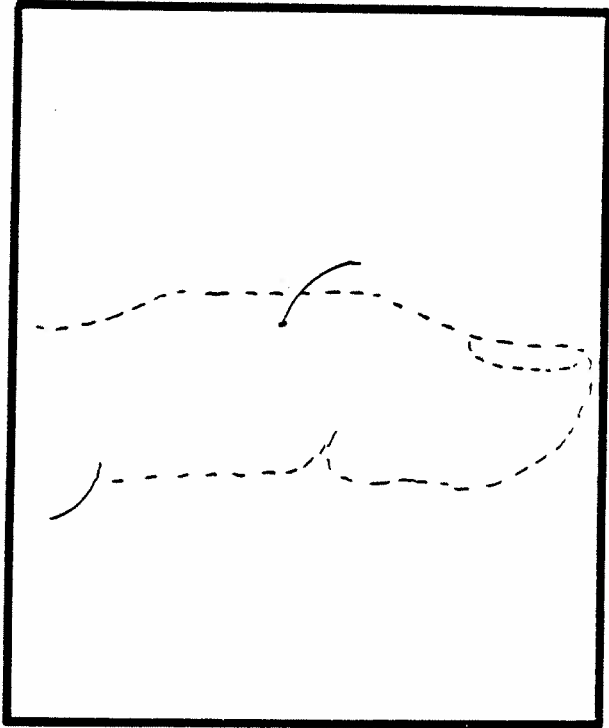

3

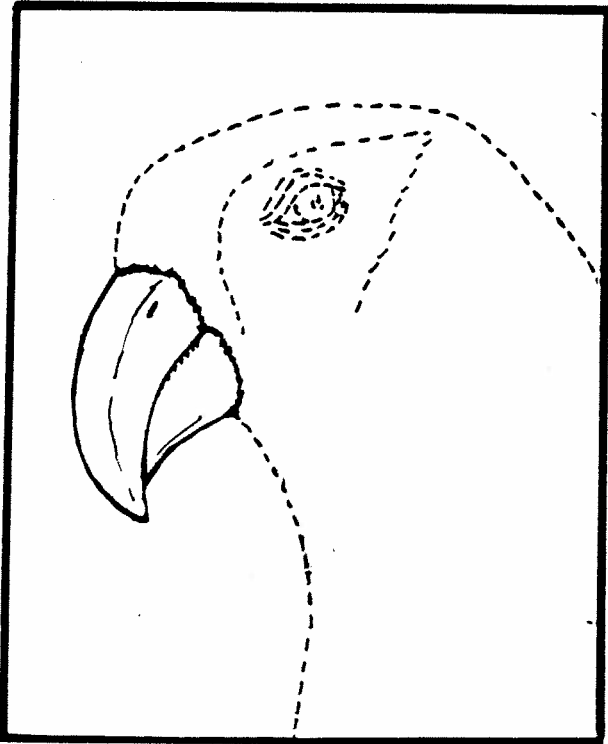

4

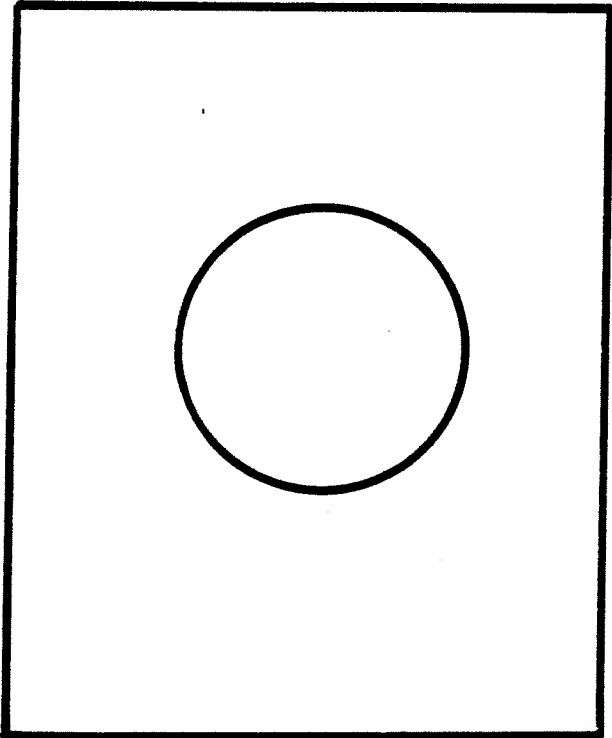

nö



1

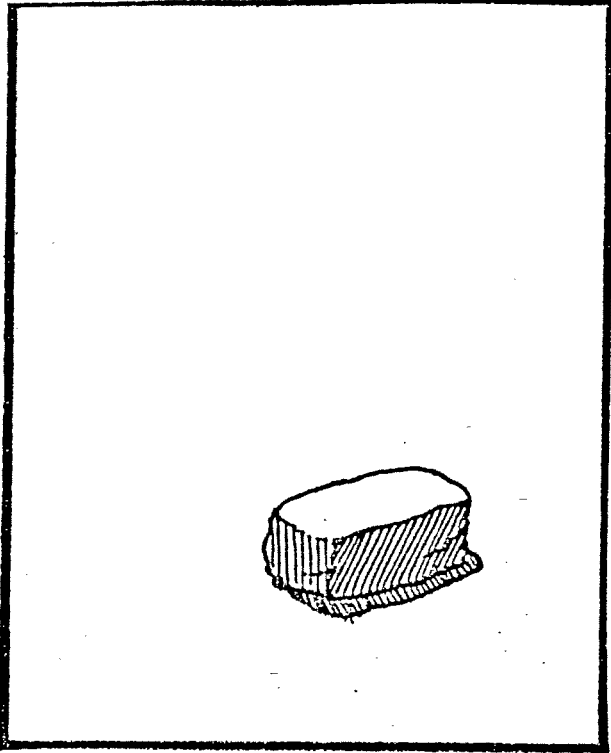

2



3

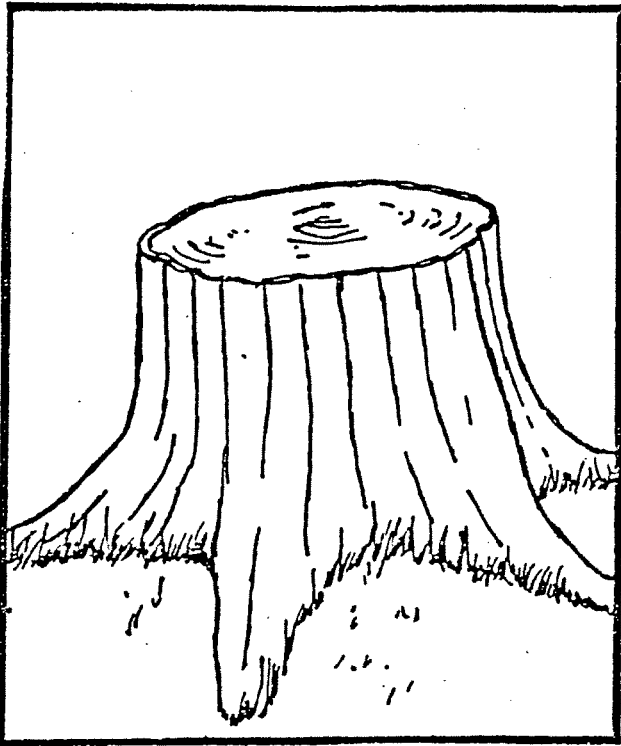

4

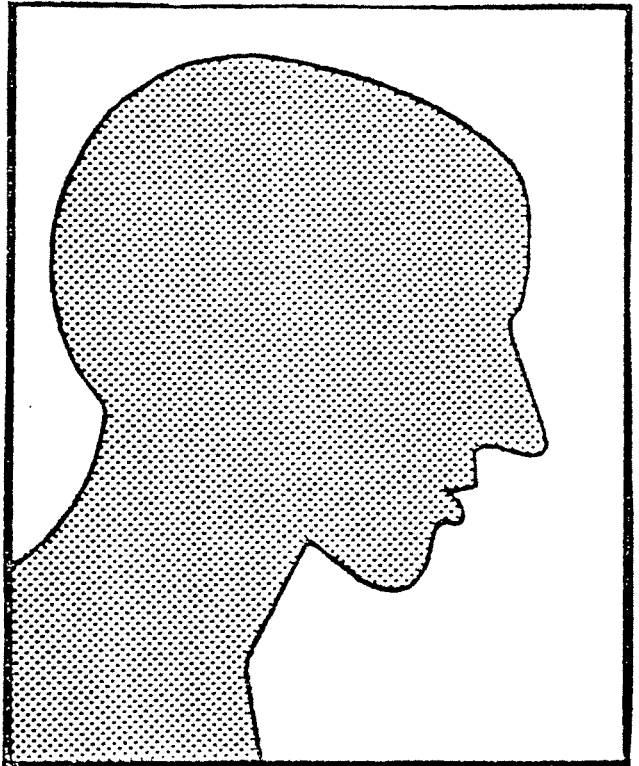



## MONDATOLVASÁS ÉS KÉPEGYEZTETÉS

A leány fogja a fiút.

1



2

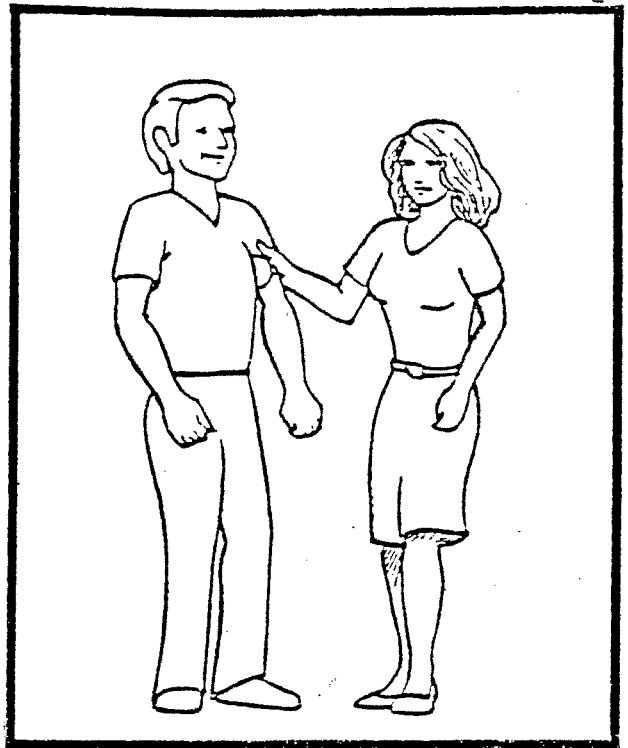

3

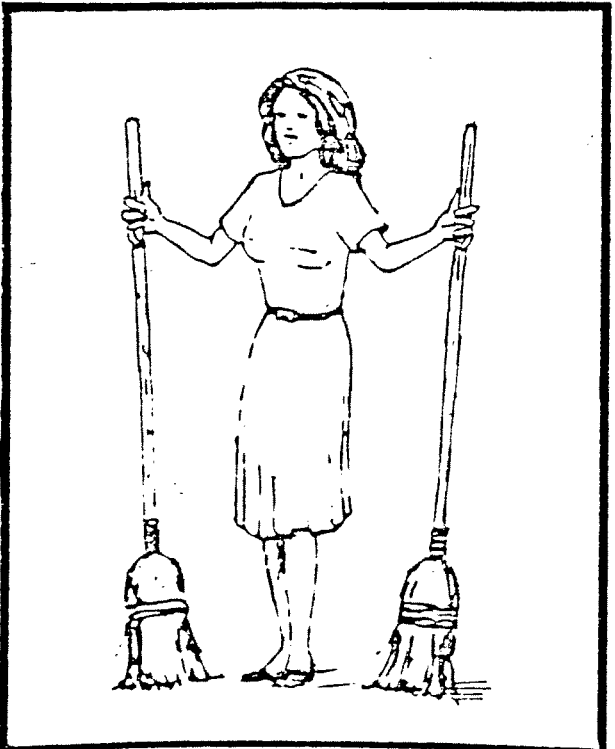

4

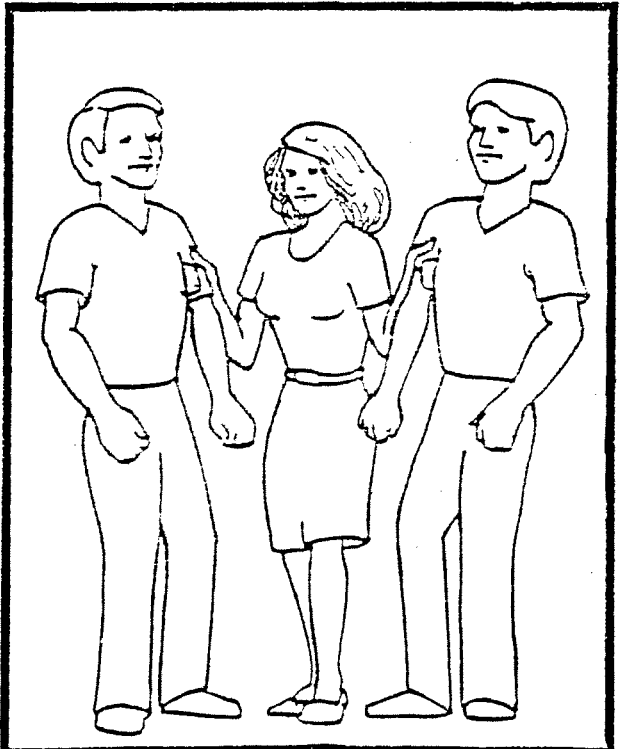

Ö hùzza öt.

1

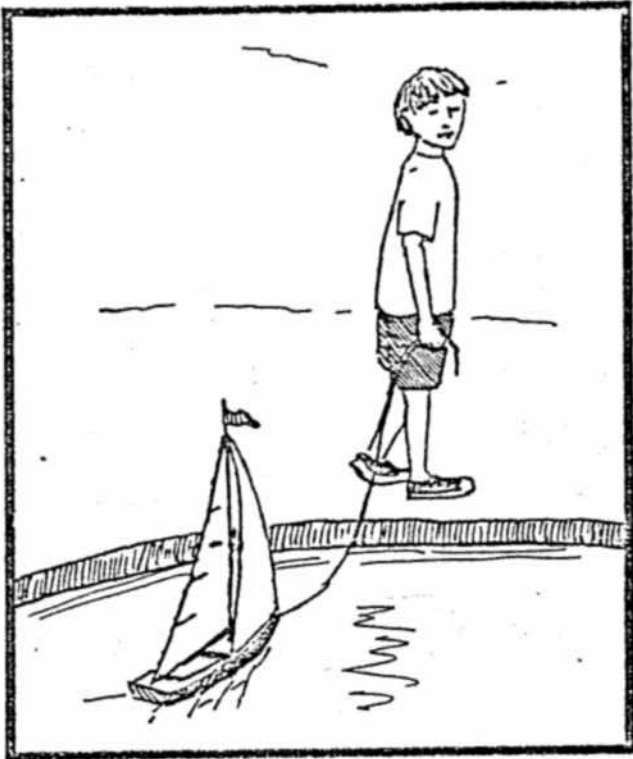

2



3

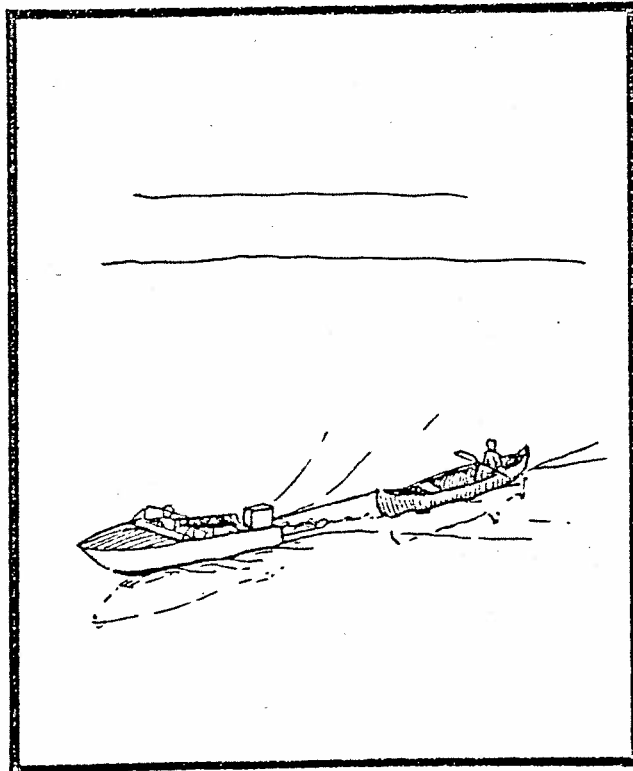

4

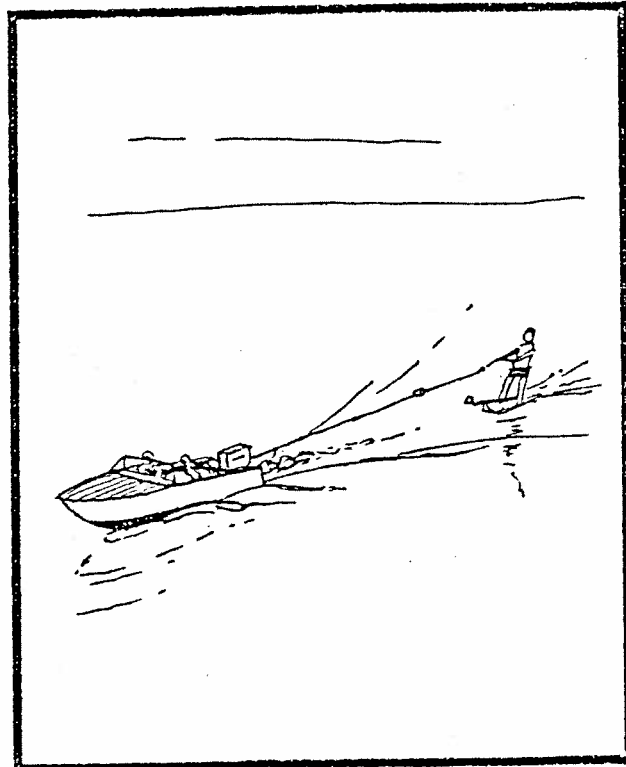

A kutyát megharapja a macska.



1

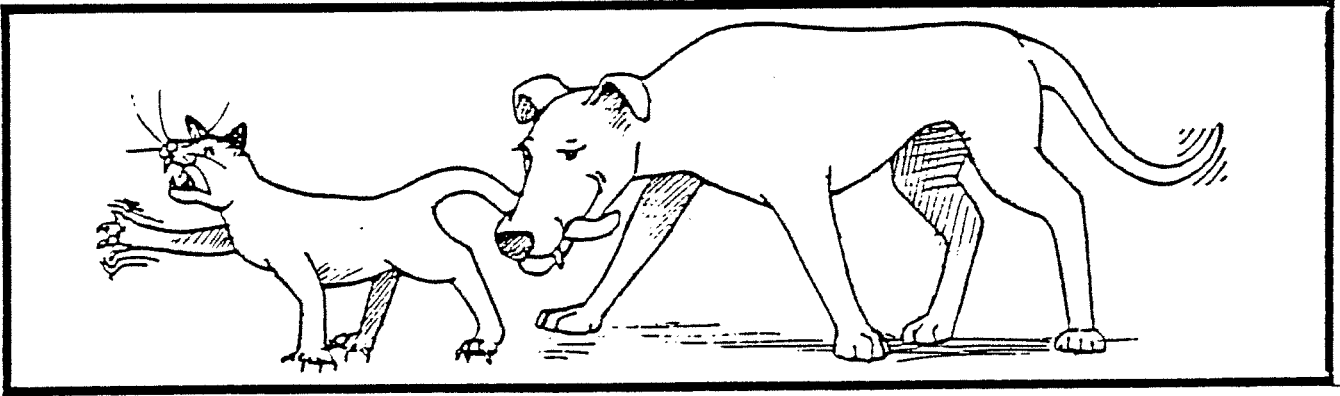

2

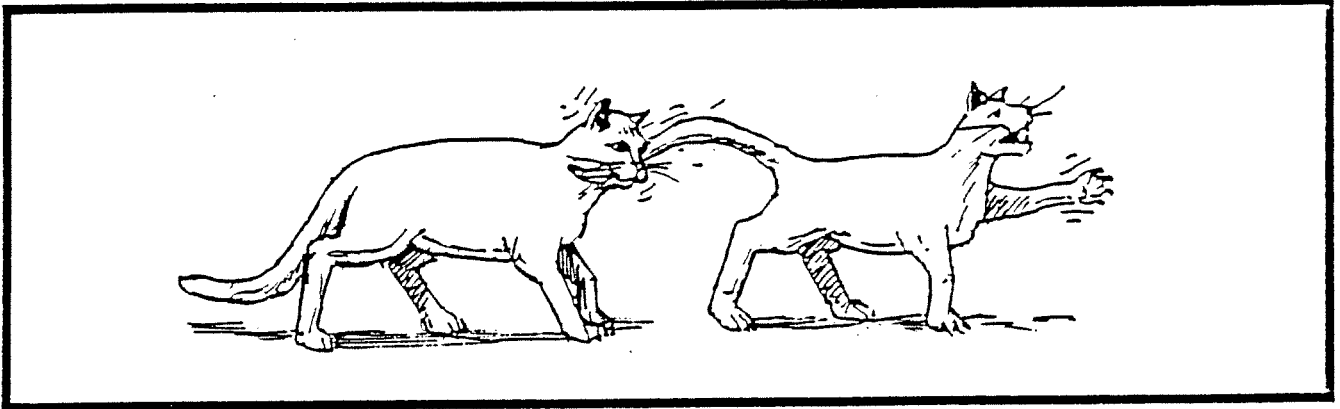

3

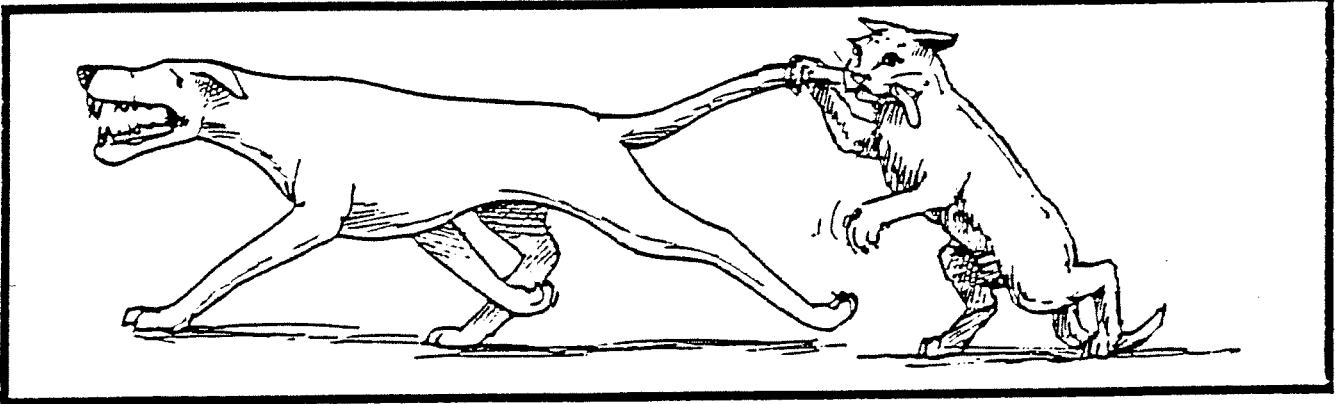

4

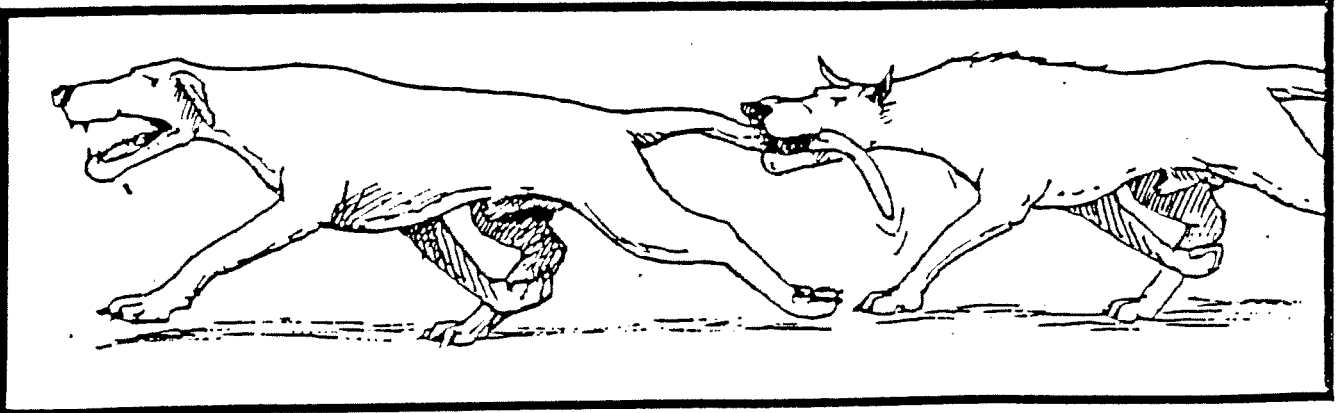

A teherautó húzza az autót.

1

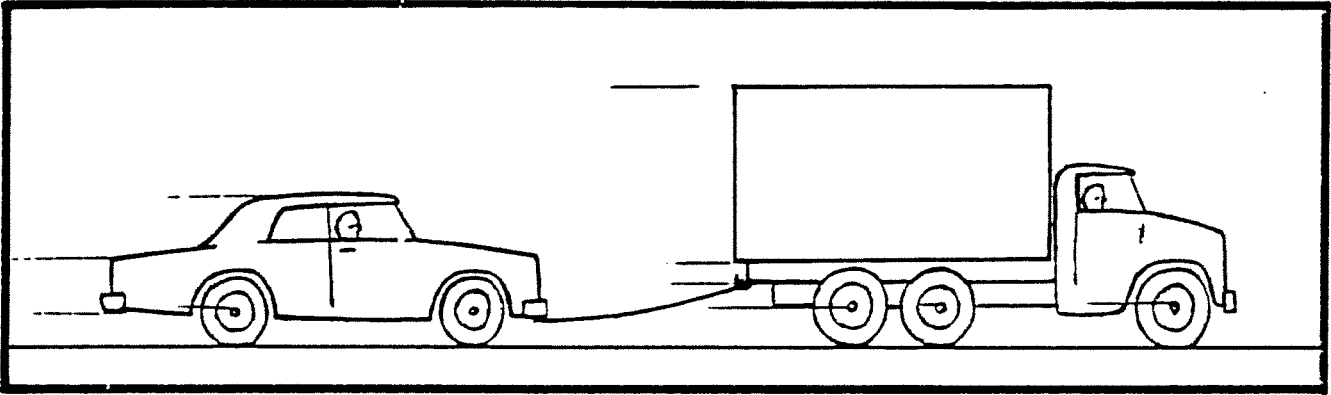

2

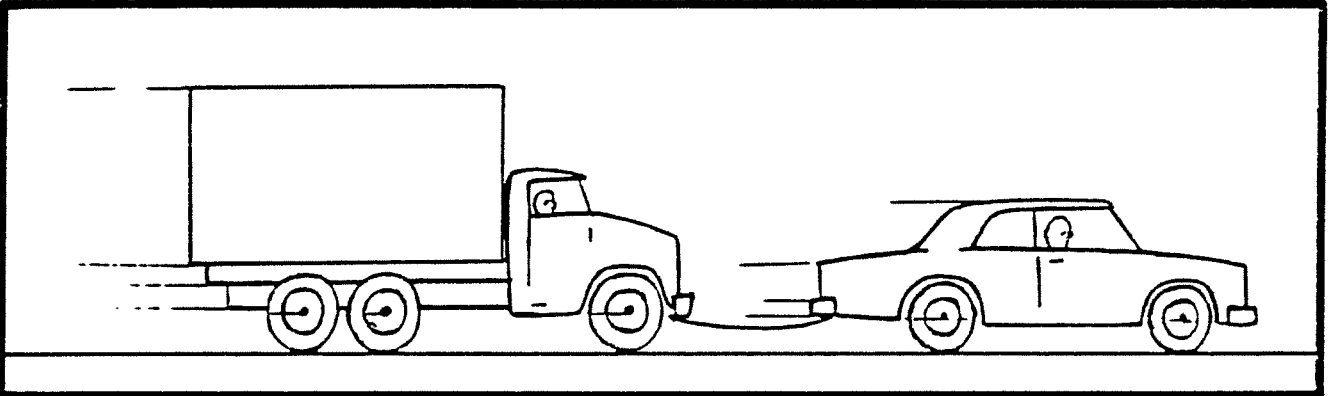

3

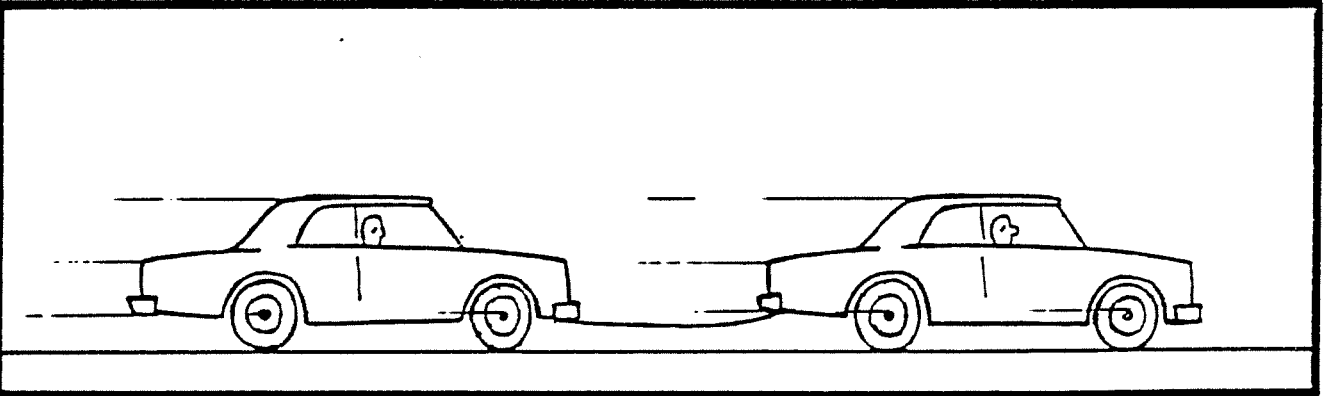

4

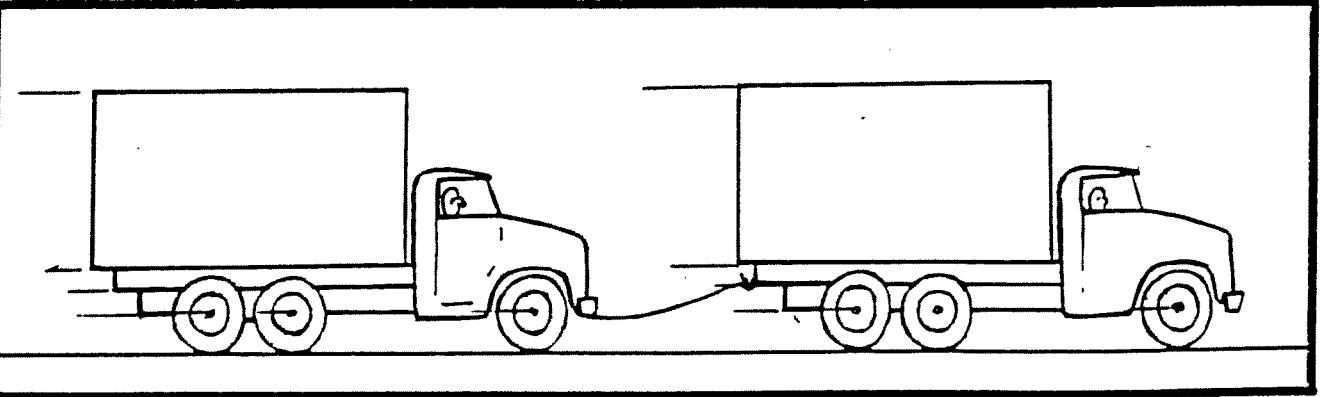

A csónak nem húzza a fiút.

1

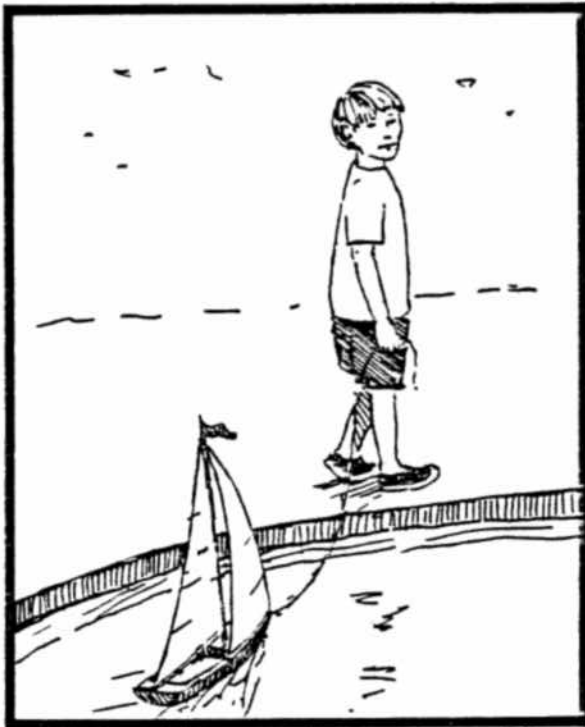

2

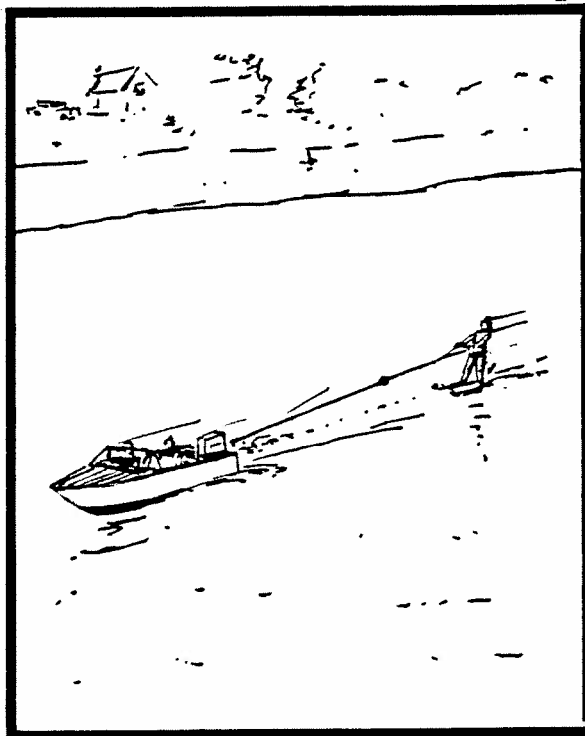

Az autó nem húzza a teherautót.

1

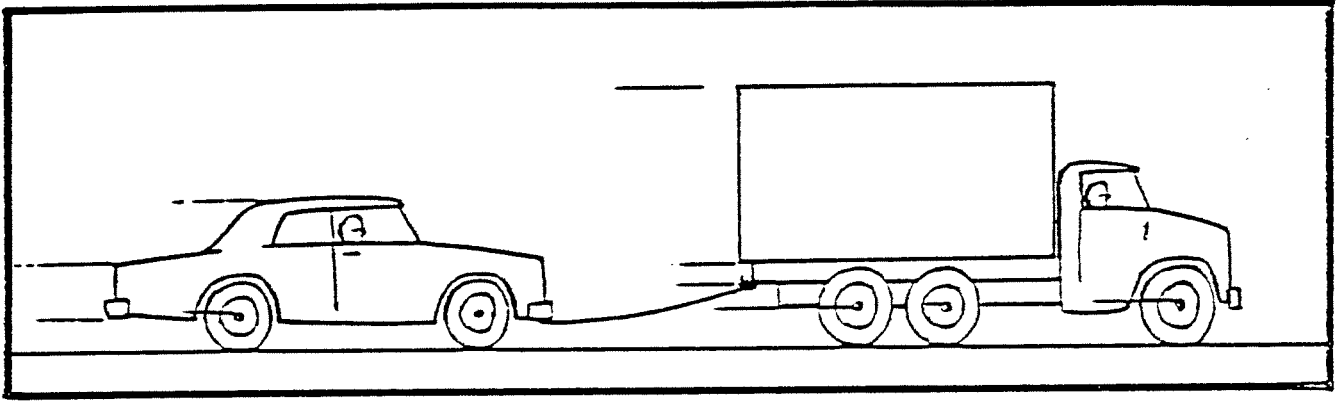

2

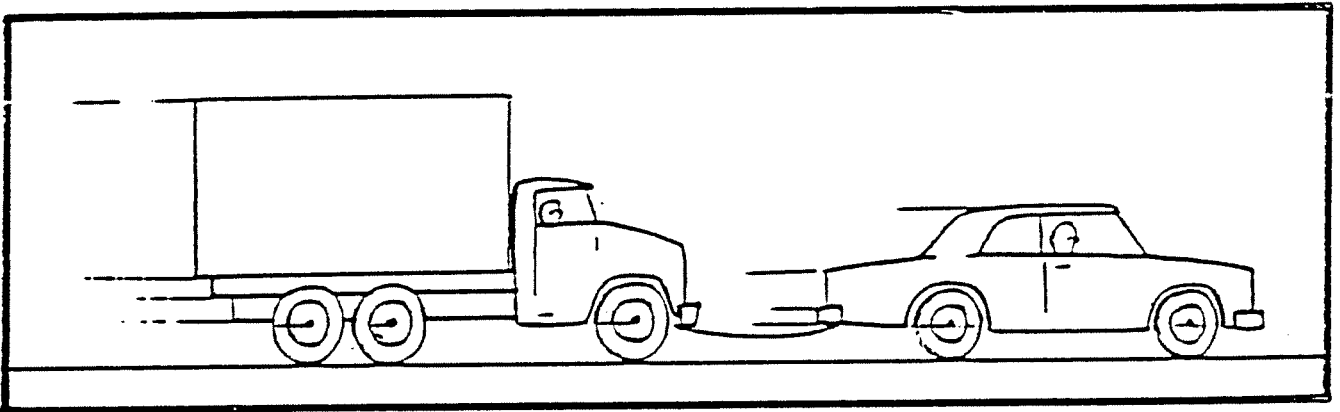

3

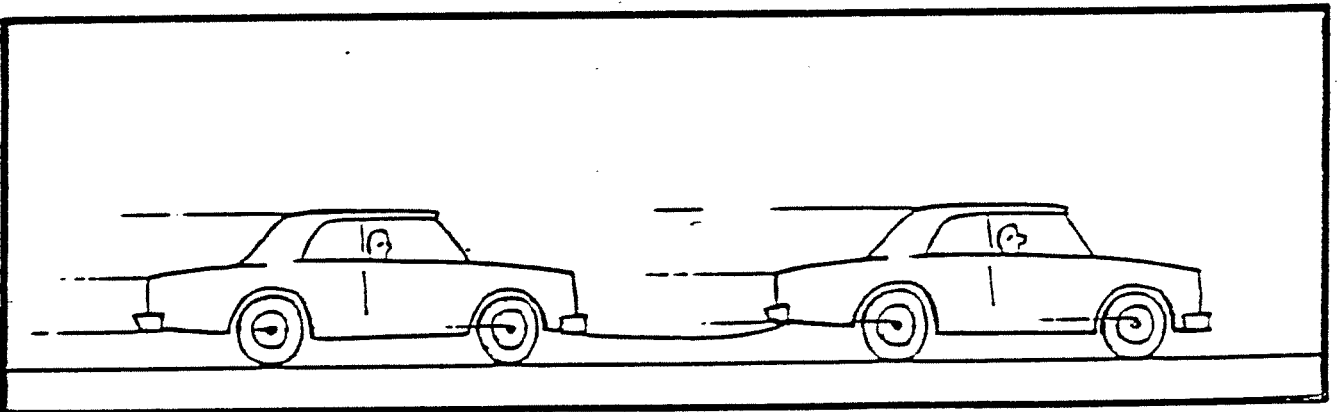

4

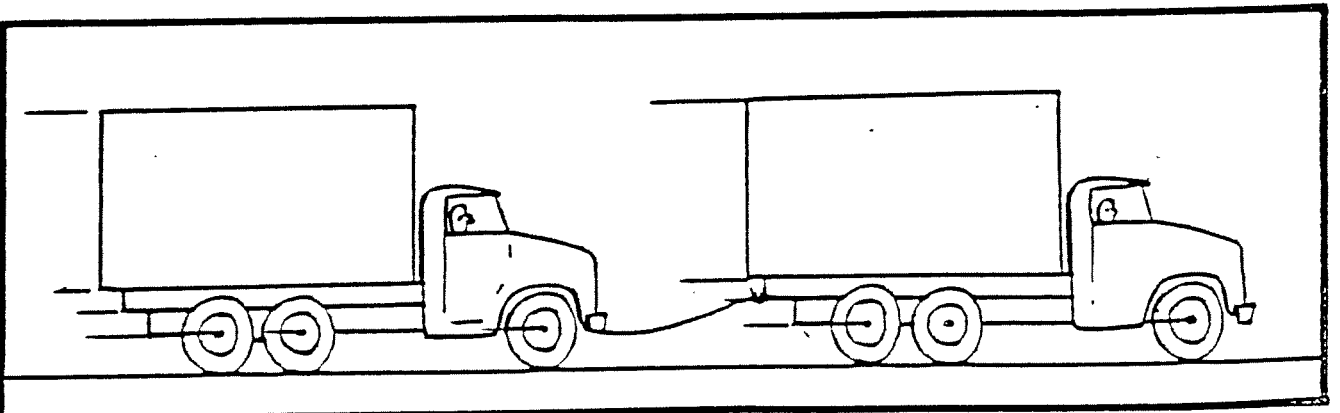

A kutyát harapja meg a macska.



1

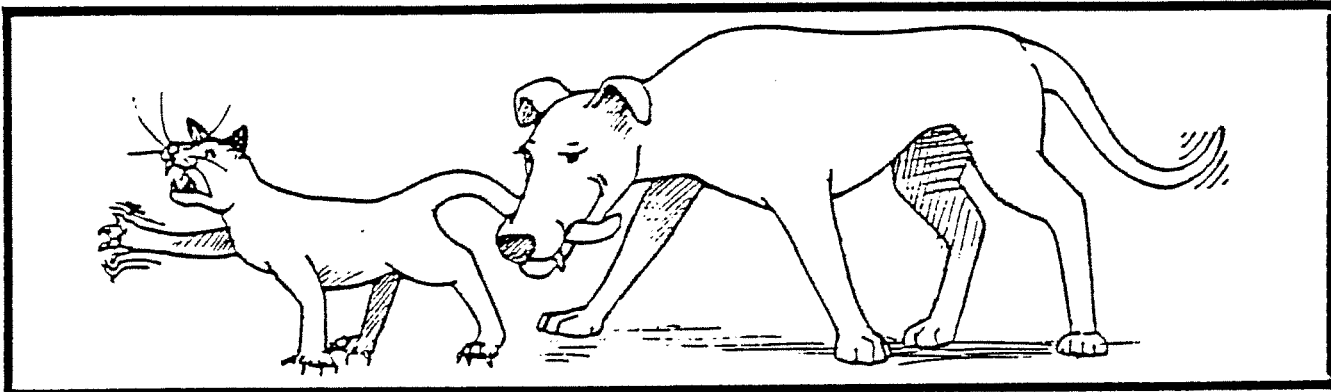

2

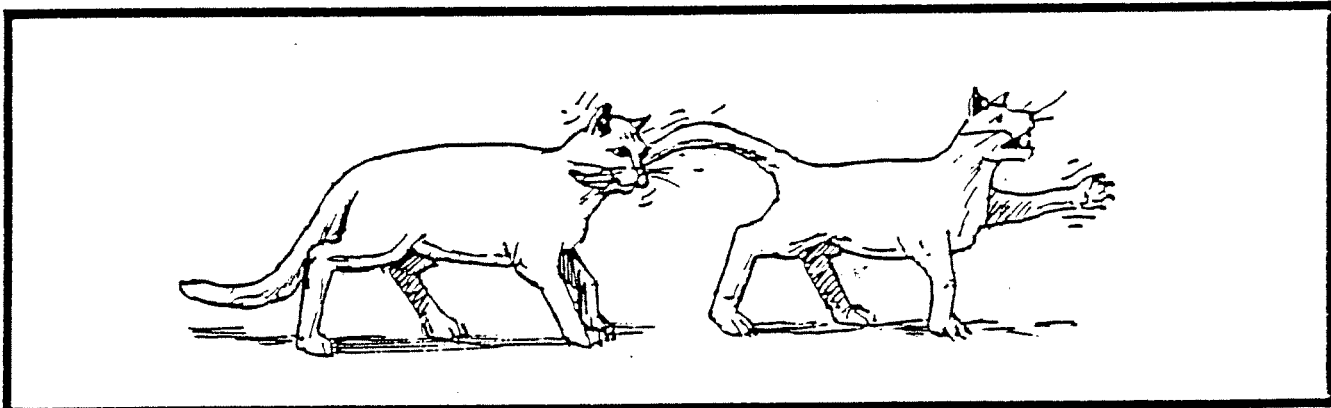

3

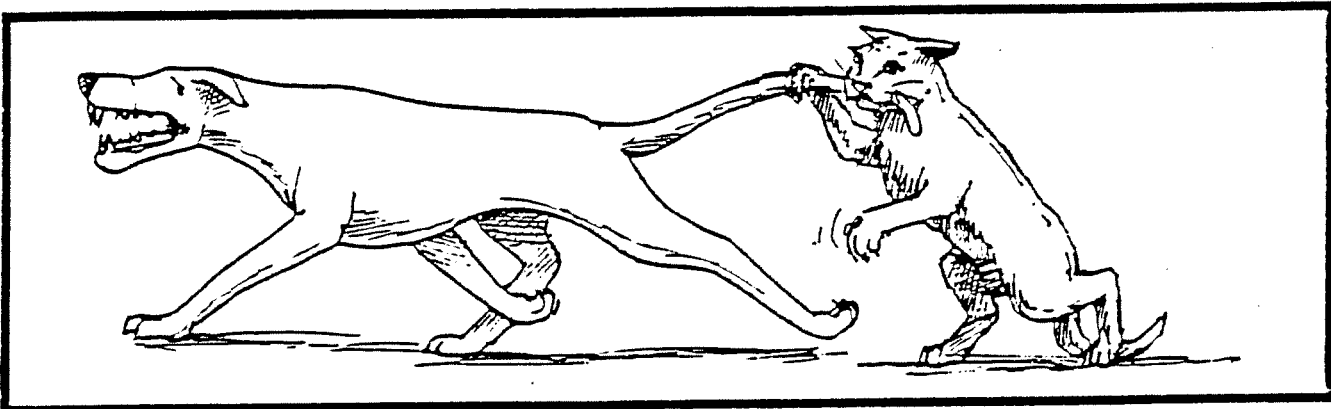

4

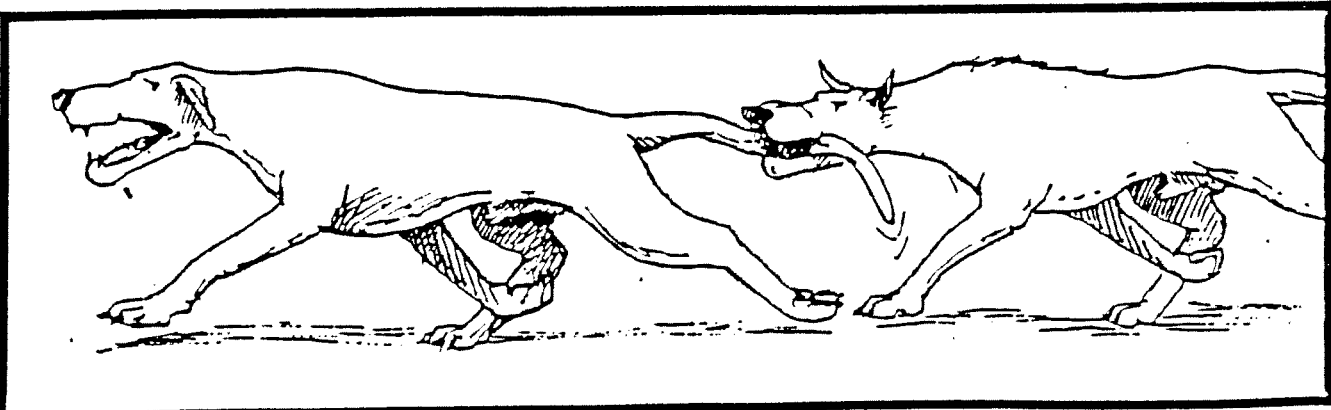

Ö fogja öt.

1



2

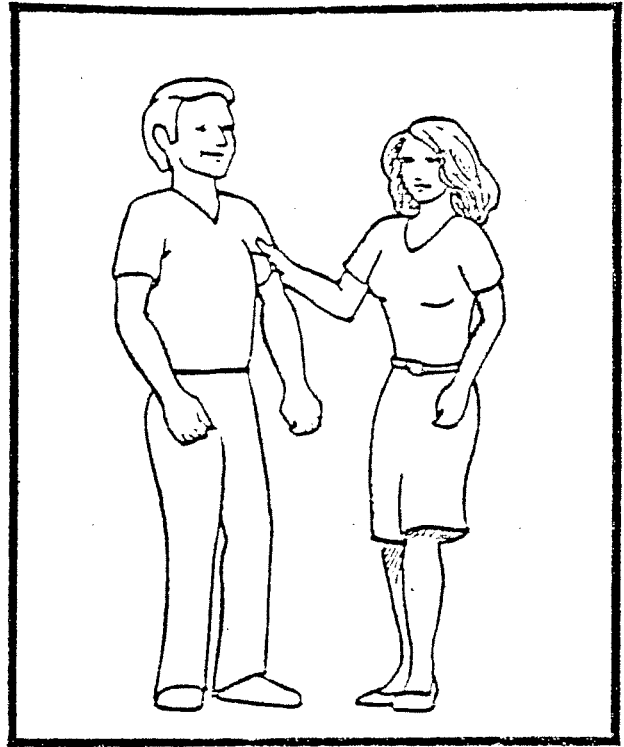

3

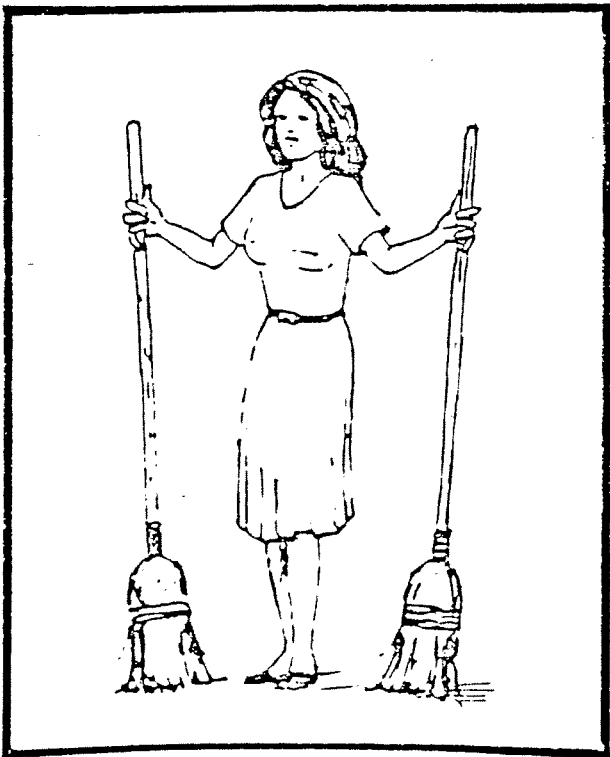

4

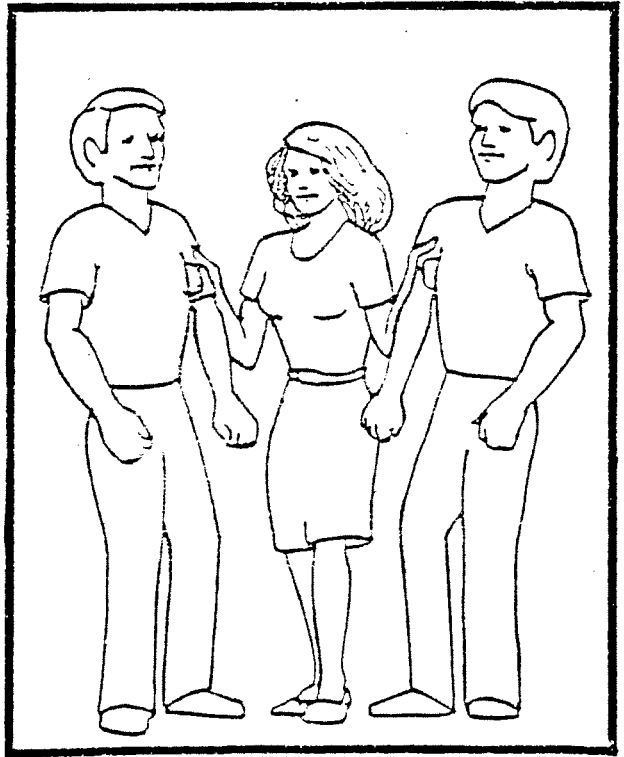

A fiút a csónak húzza.

1

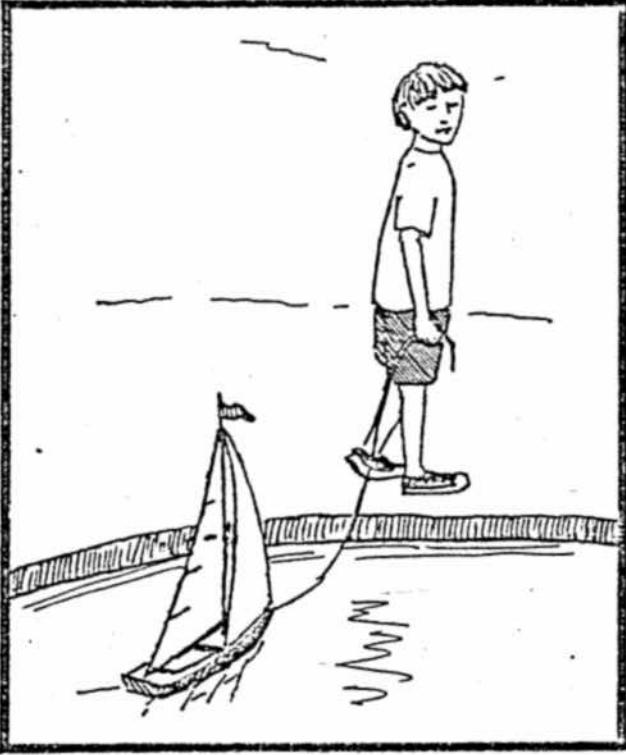

2

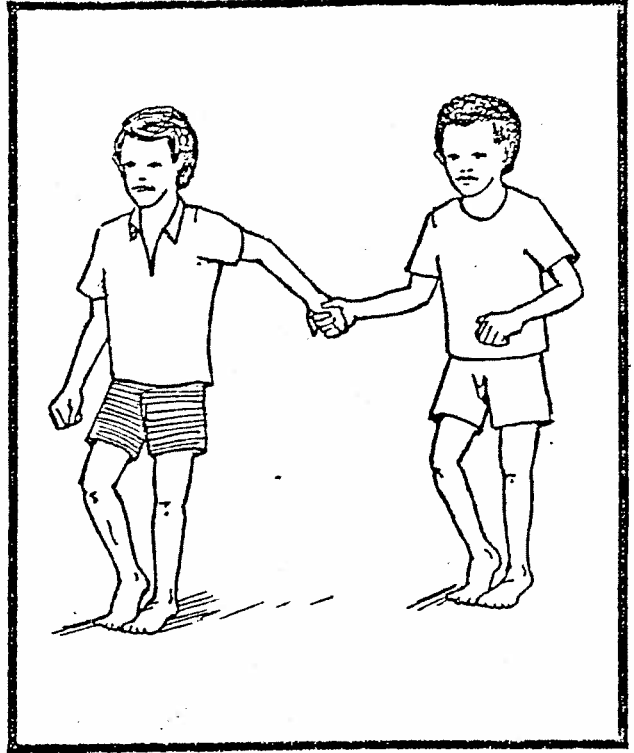

3

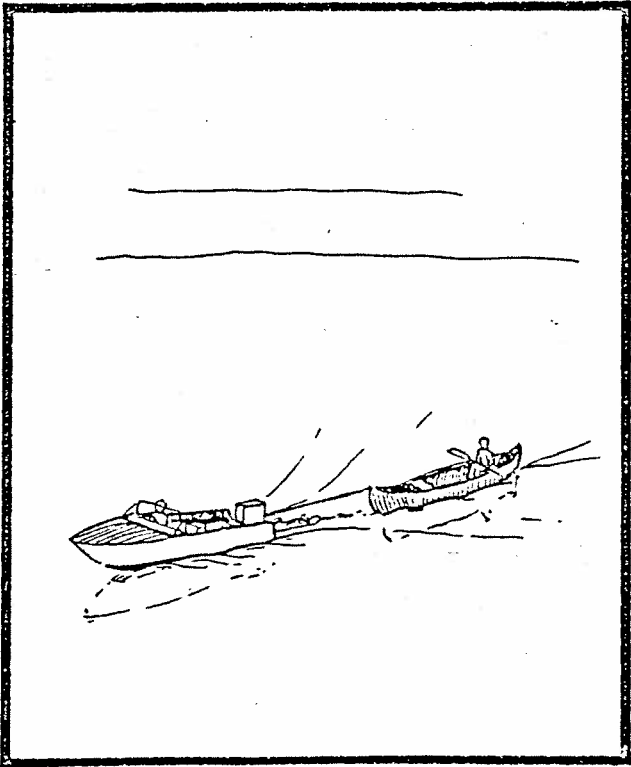

4

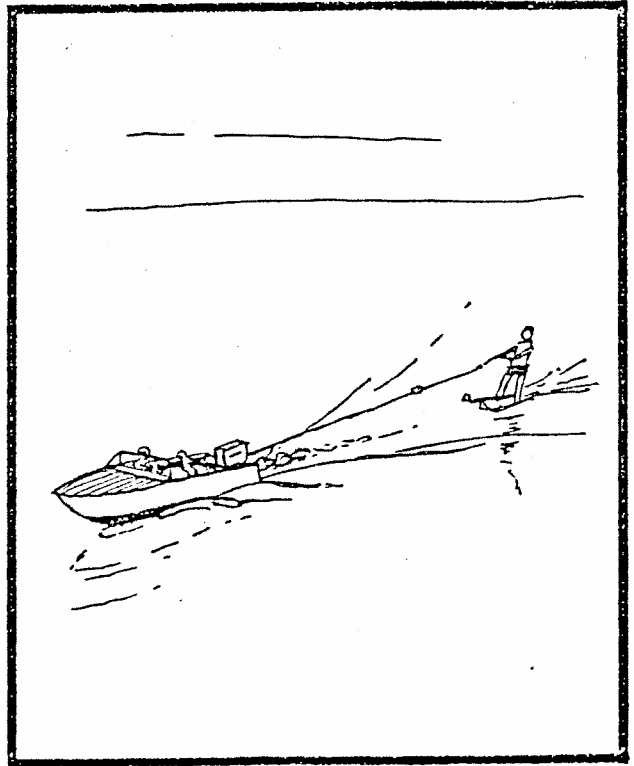

A fiút nem üti meg a labda.

1

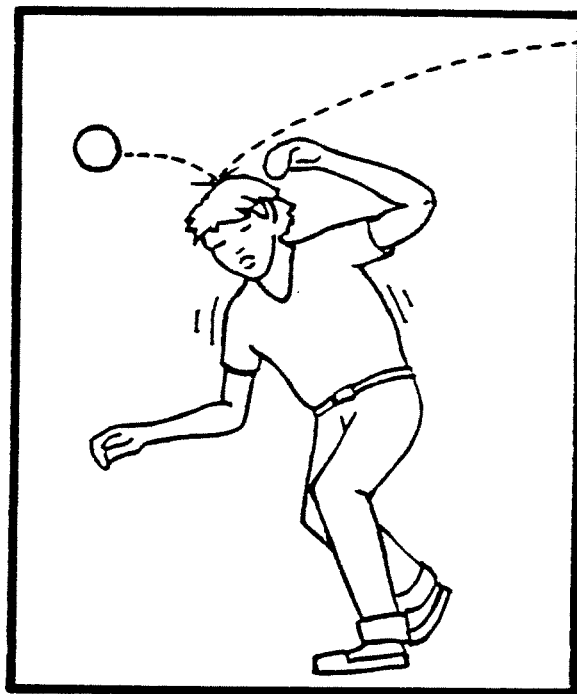

2

