

Michel Paradis  
McGill University

BILINGUAL APHASIA TEST  
(FINNISH VERSION)

STIMULUS BOOK

SUOMI

The development of the Bilingual Aphasia Test materials was supported by Grant MEQ 01-07-k (1976-1983) from the Quebec Ministry of Intergovernmental Affairs, Grant EQ 1660 (1980-1985) from the Quebec Ministry of Education FCAC Fund, and Grants 410-83-1028 (1984, 1985) and 410-88-0821 (1989-1991) from the Social Sciences and Humanities Research Council of Canada.

## AUDITIIVINEN VERBAALINEN DISKRIMINAATIO

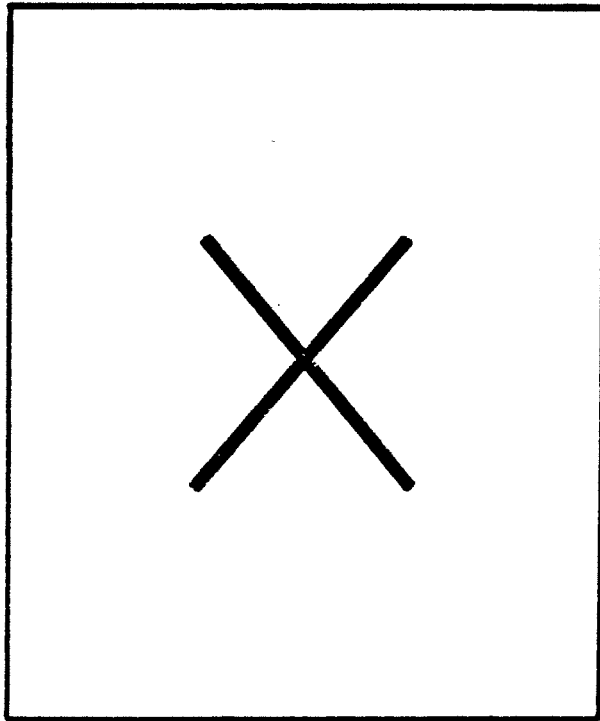

1

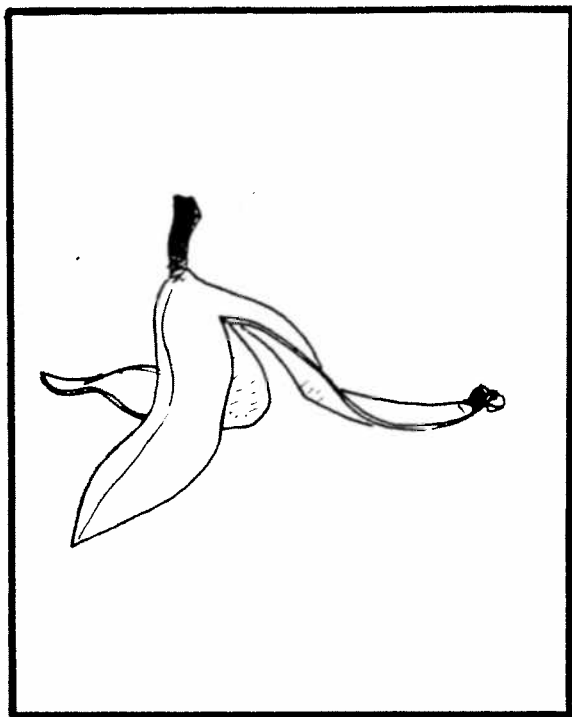

2

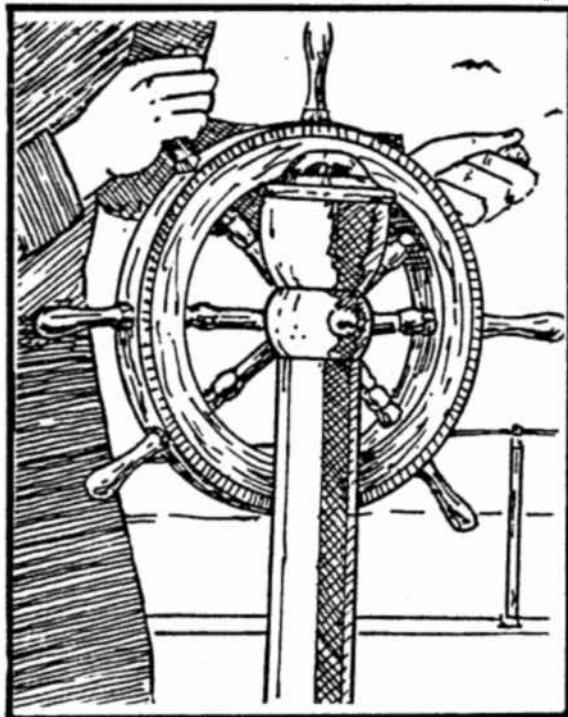

3



4



Esimerkki

1

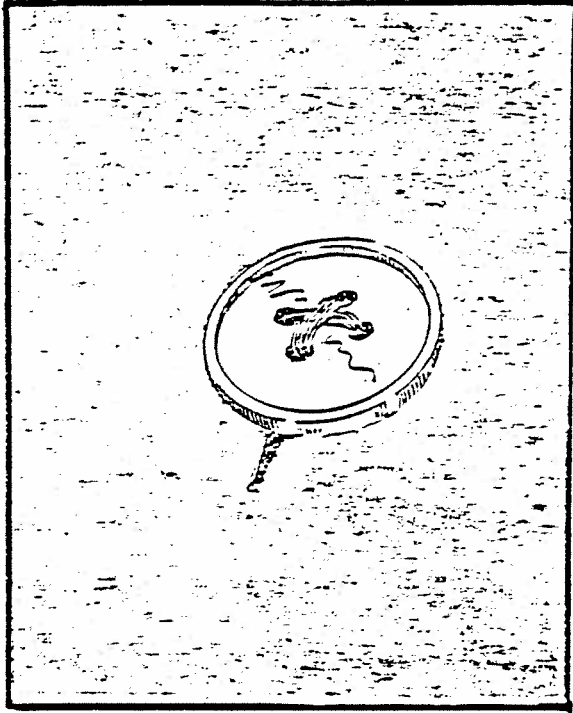

2

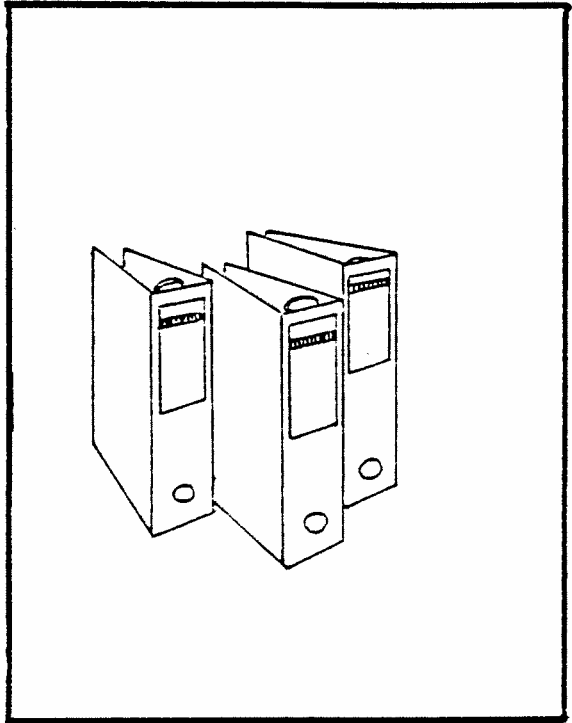

3



4

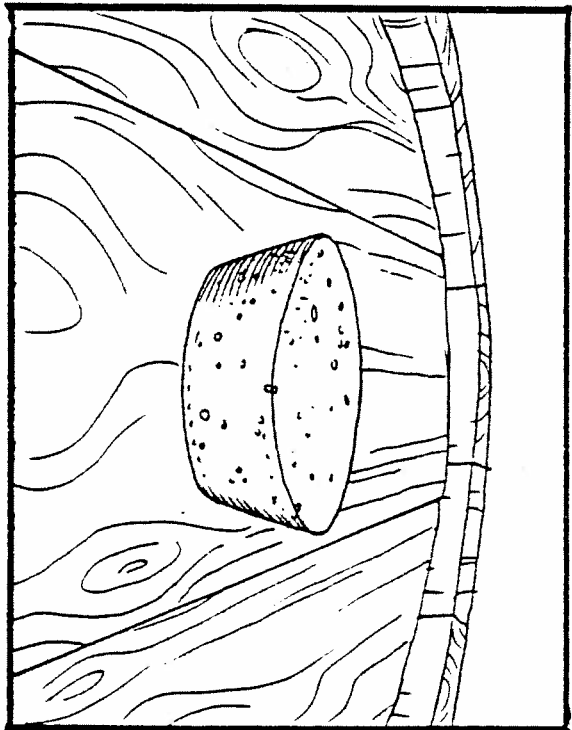

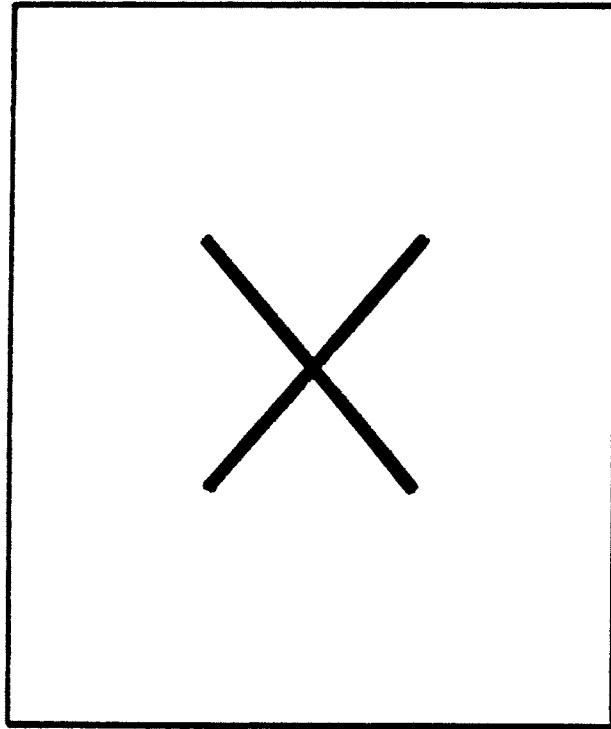

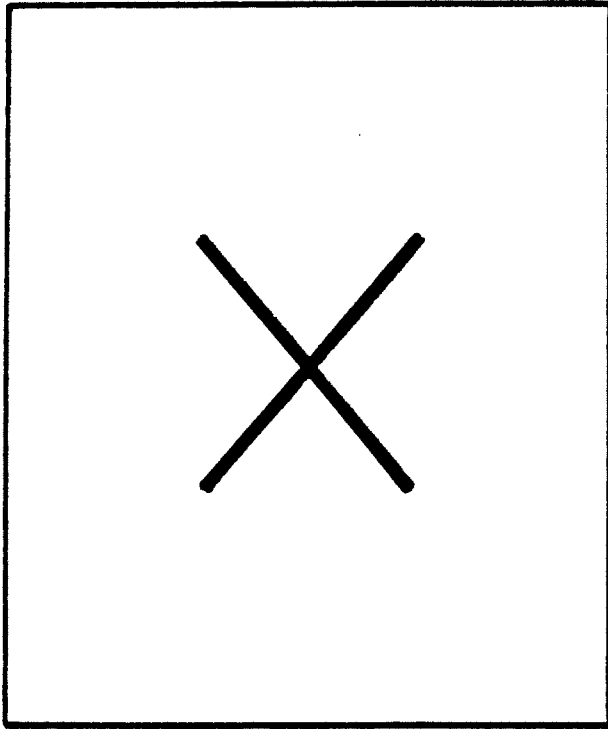



1

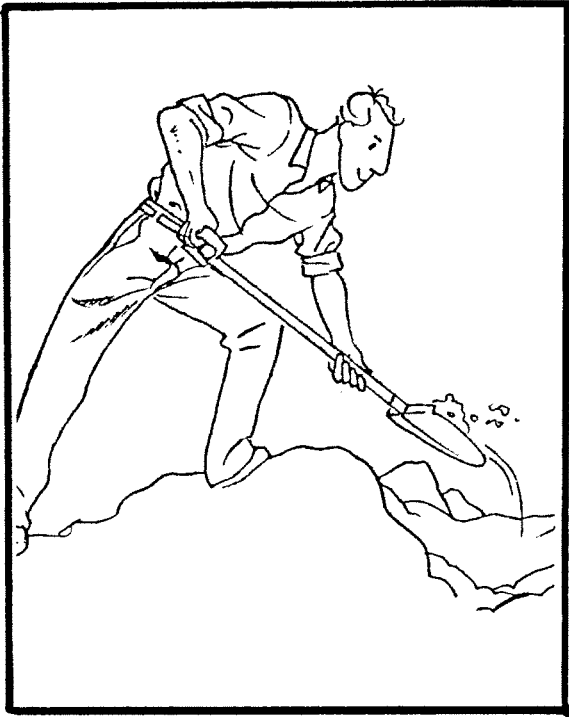

2

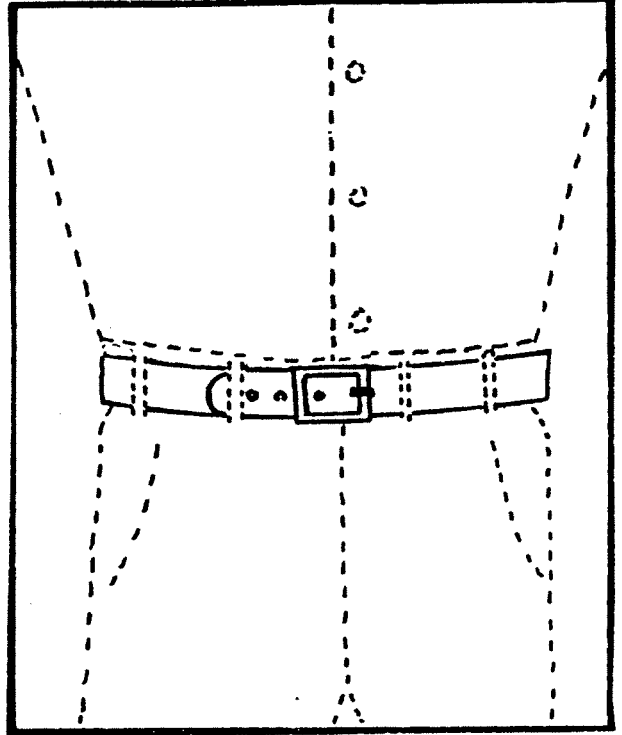

3



4

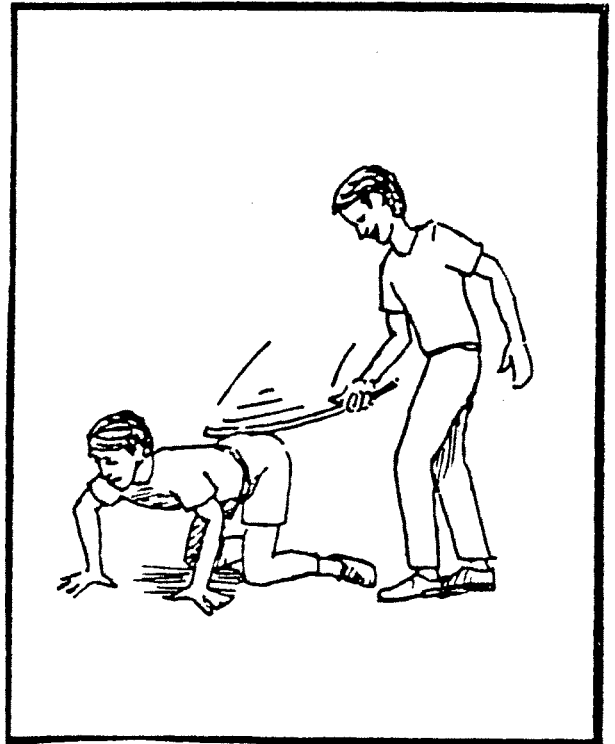

1

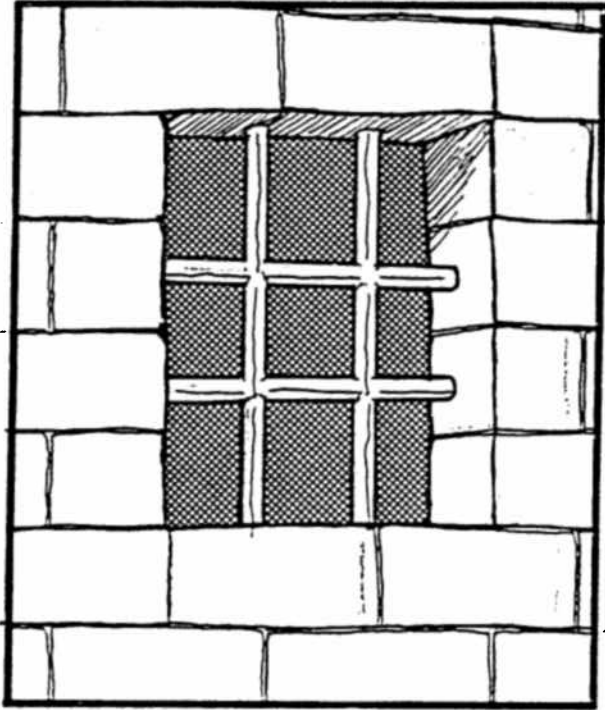

2

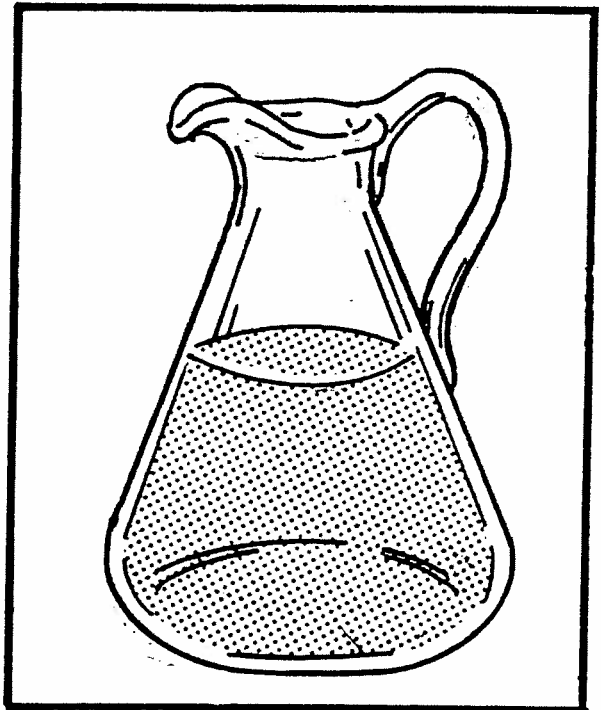

3

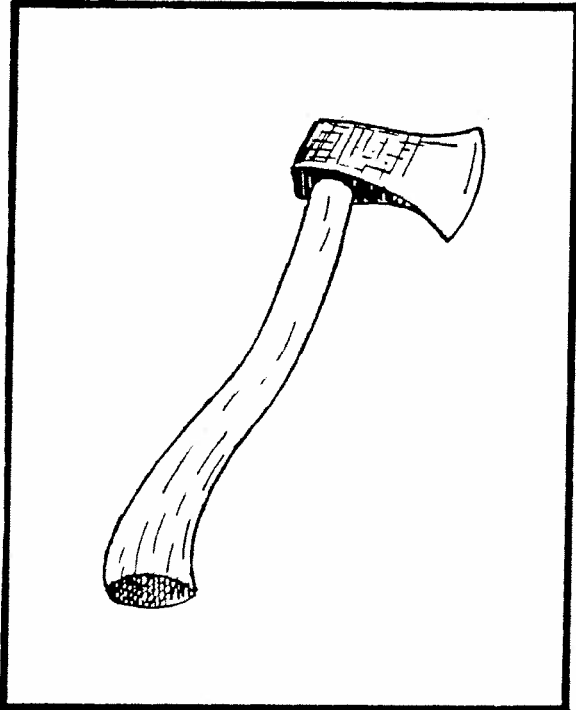

4

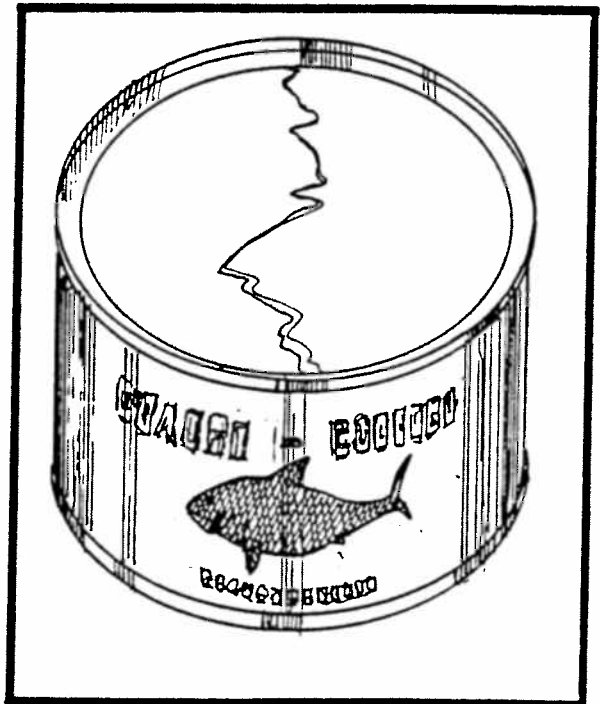

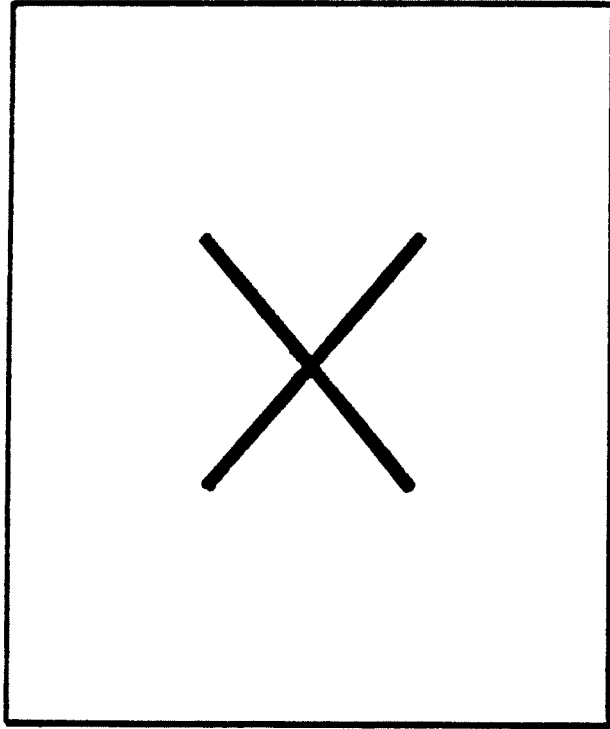

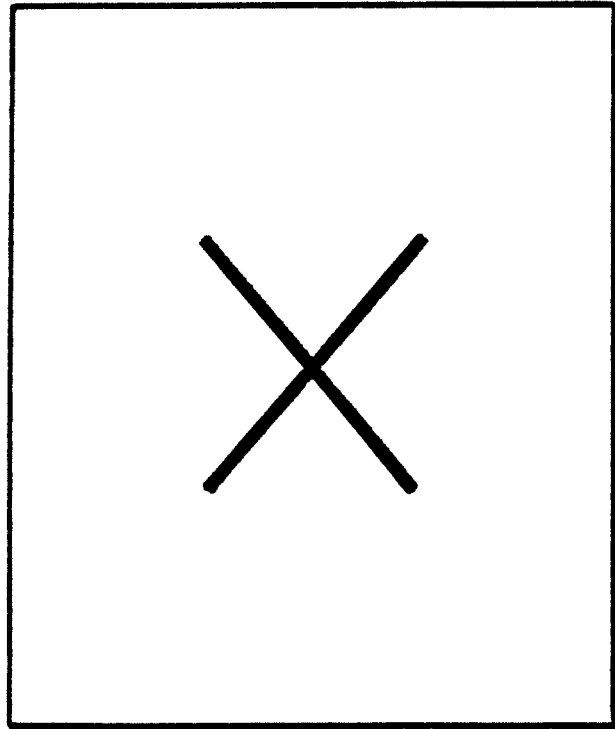

1

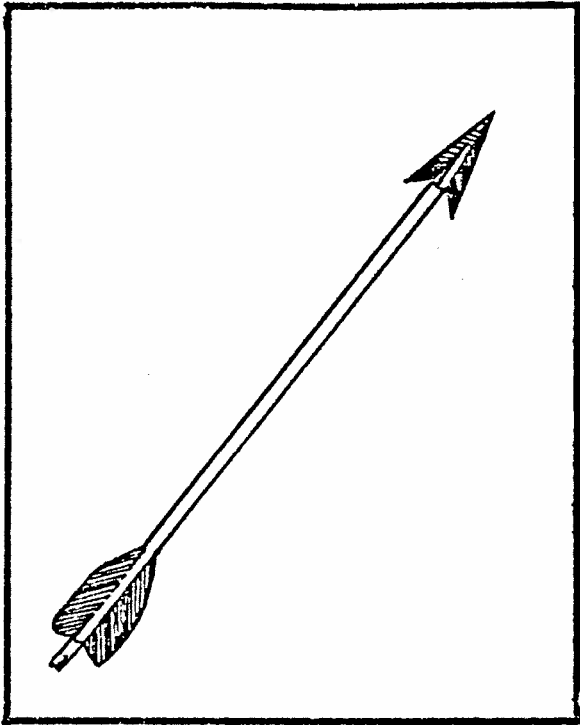

2

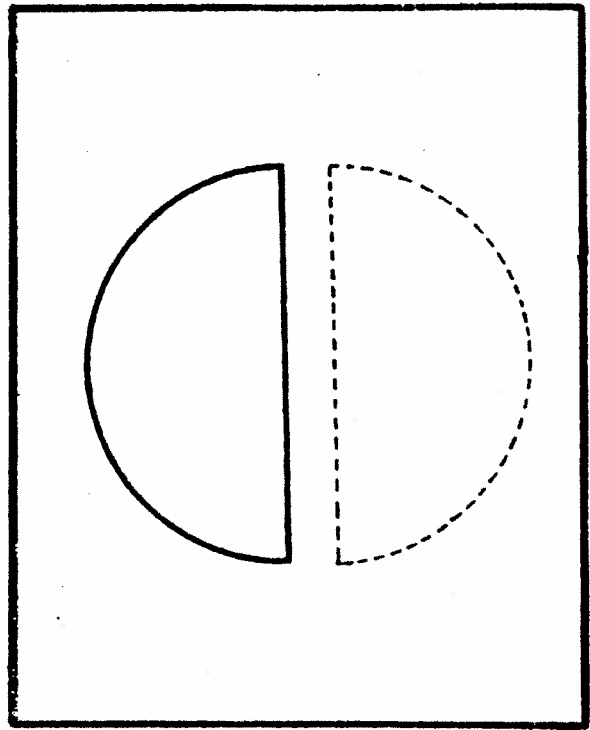

3

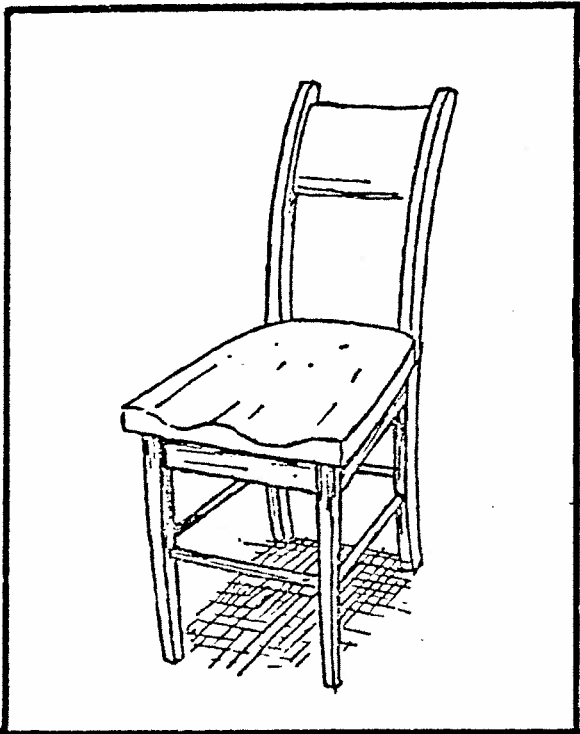

4

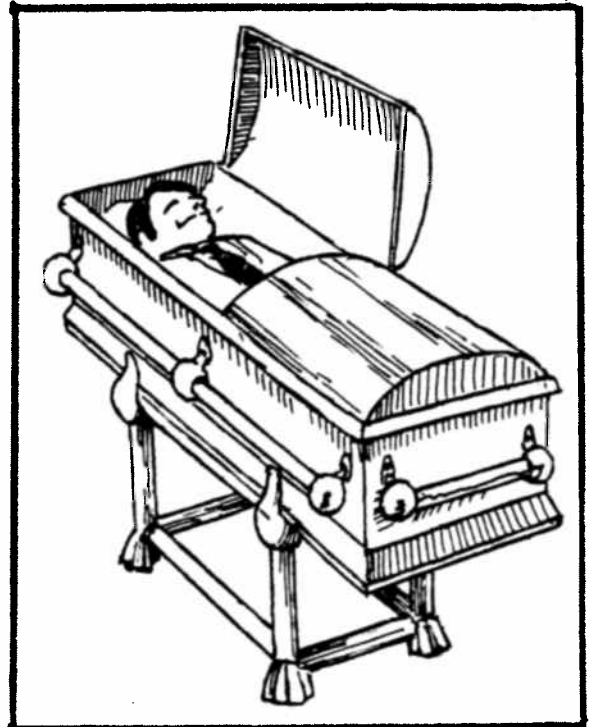

1

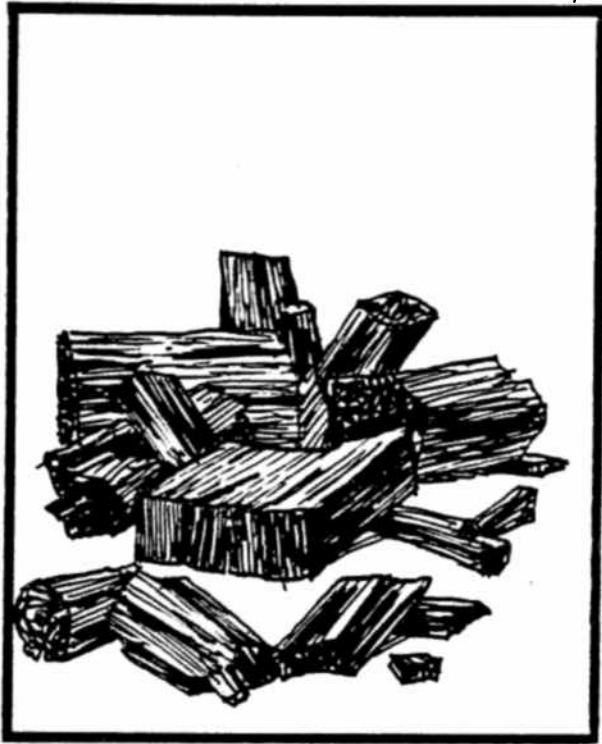

2

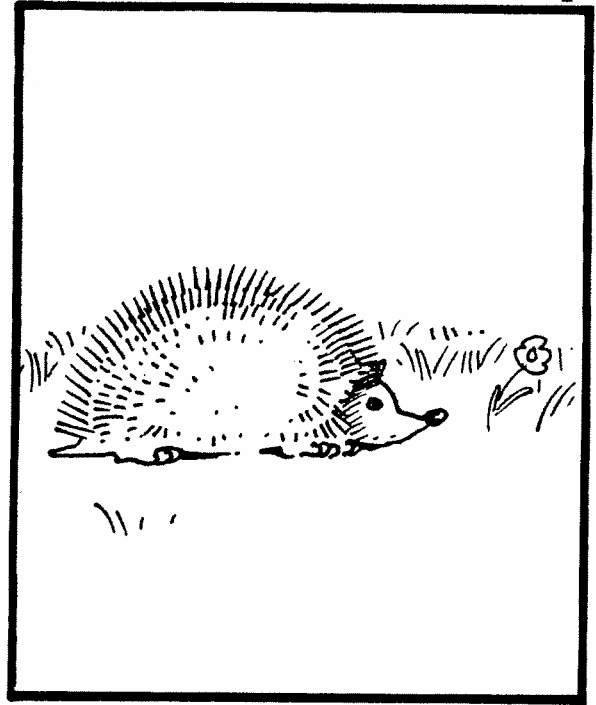

3



4

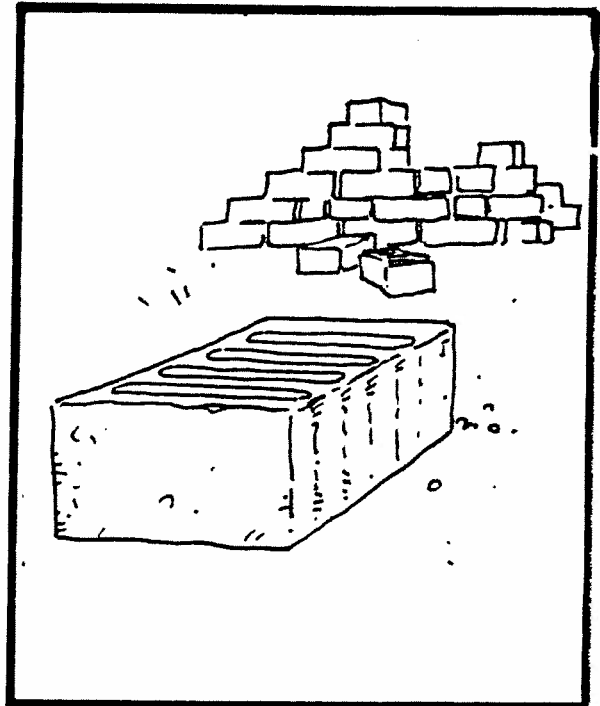

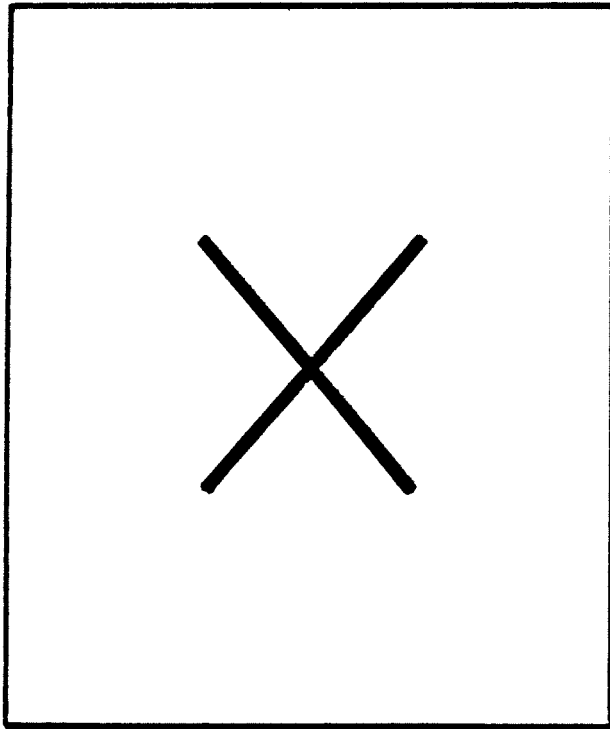

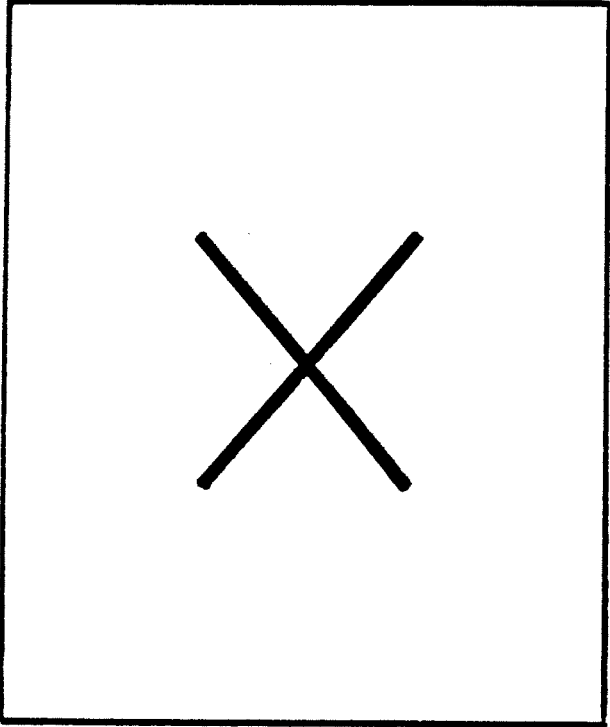



1

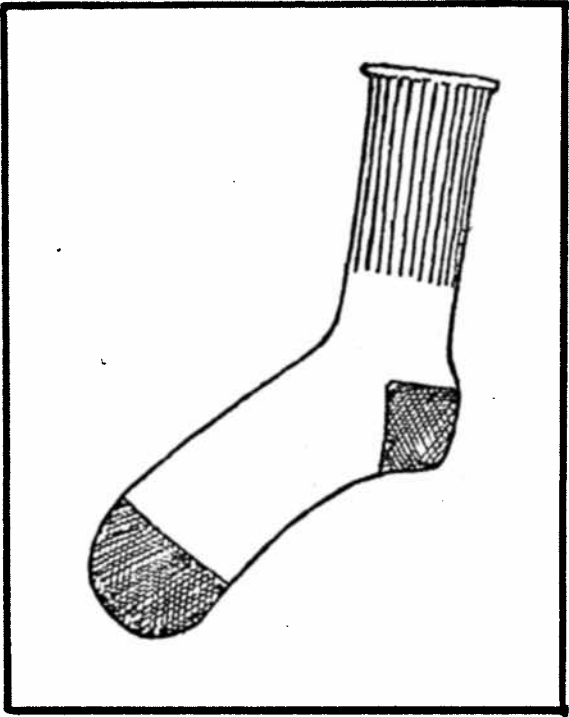

2

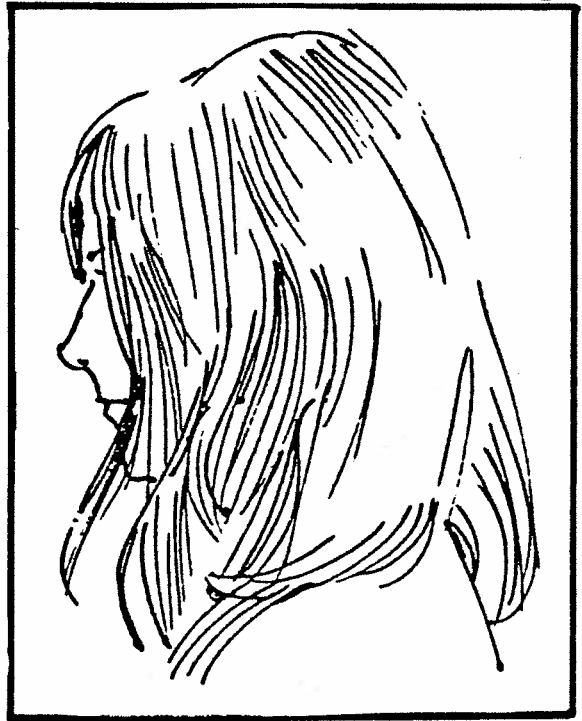

3

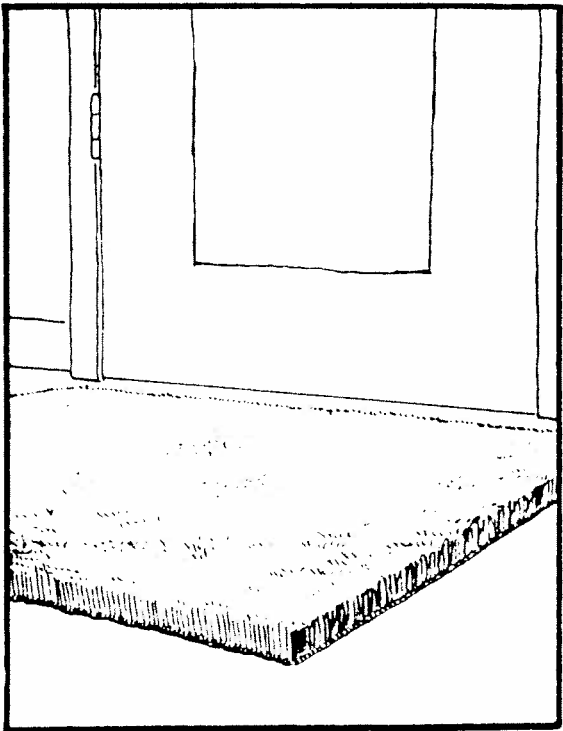

4

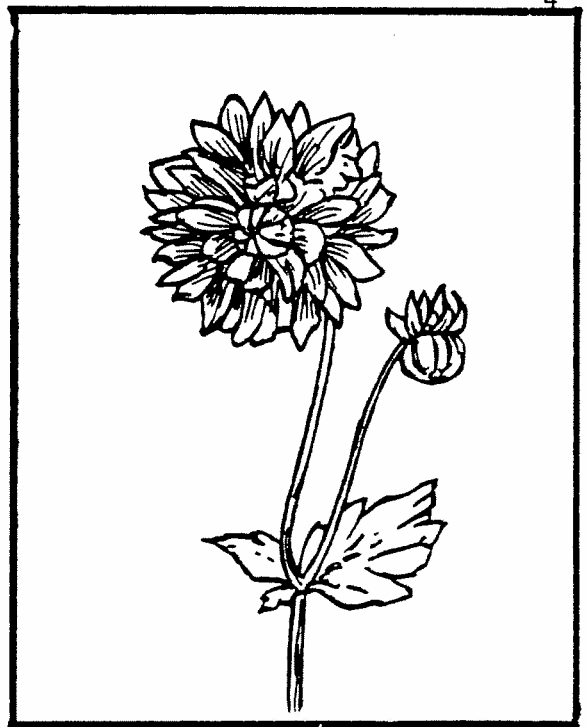

1

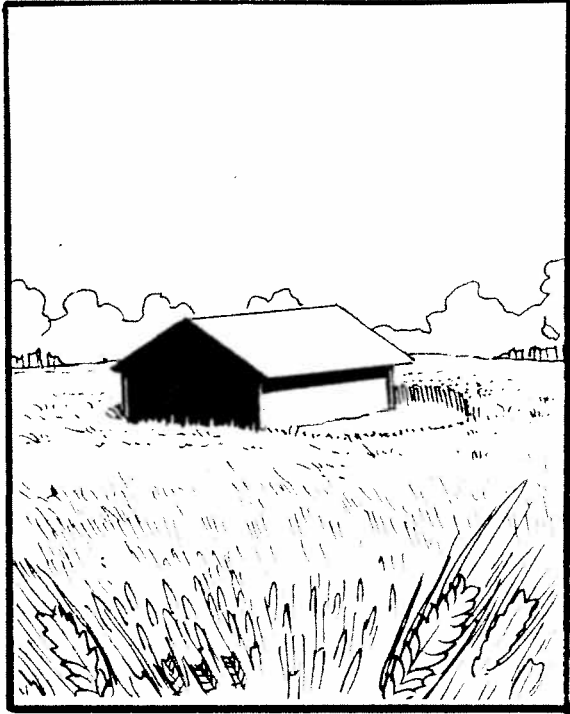

2

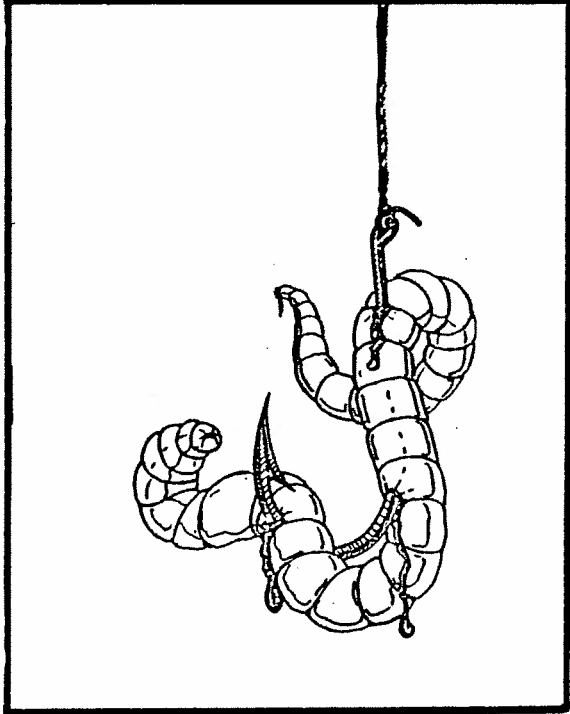

3



4

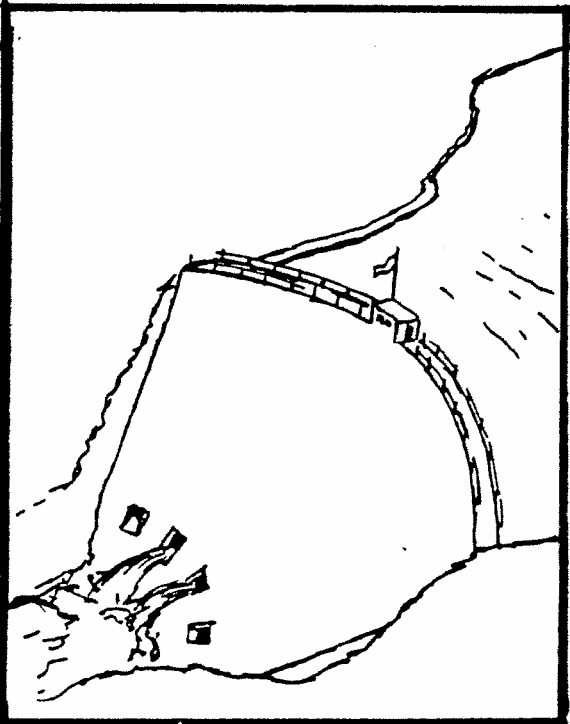

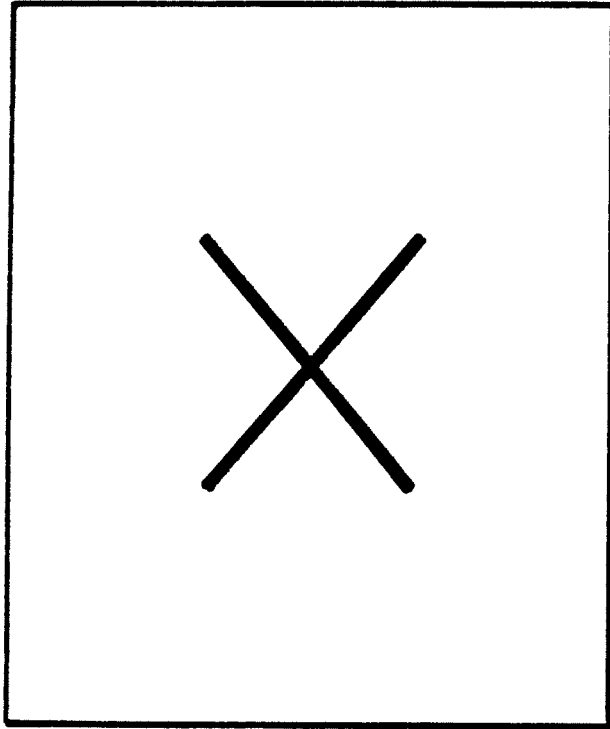

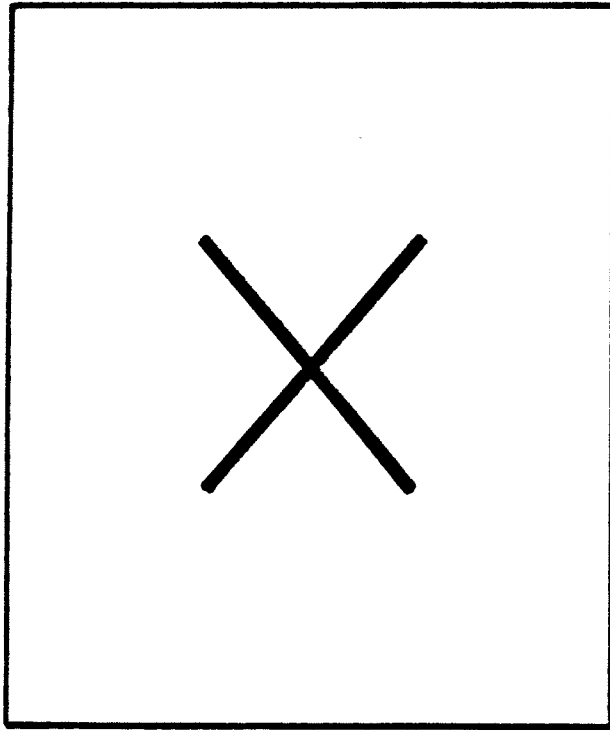

1

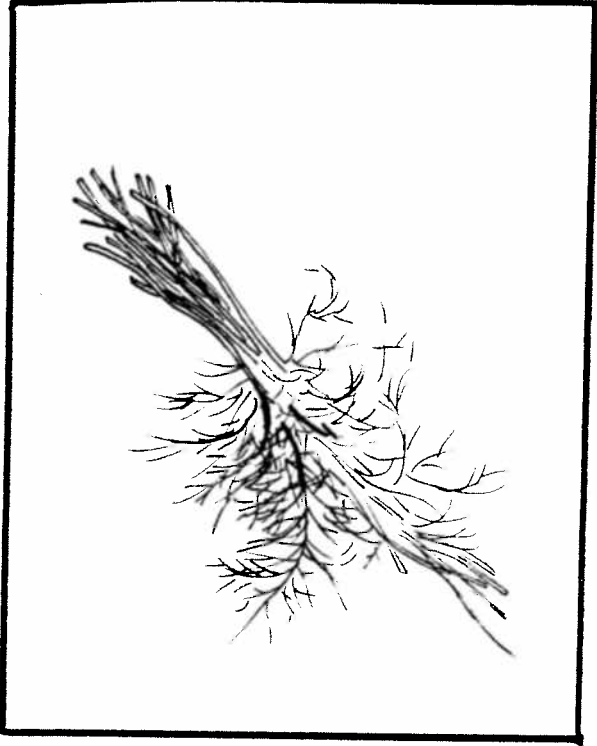

2

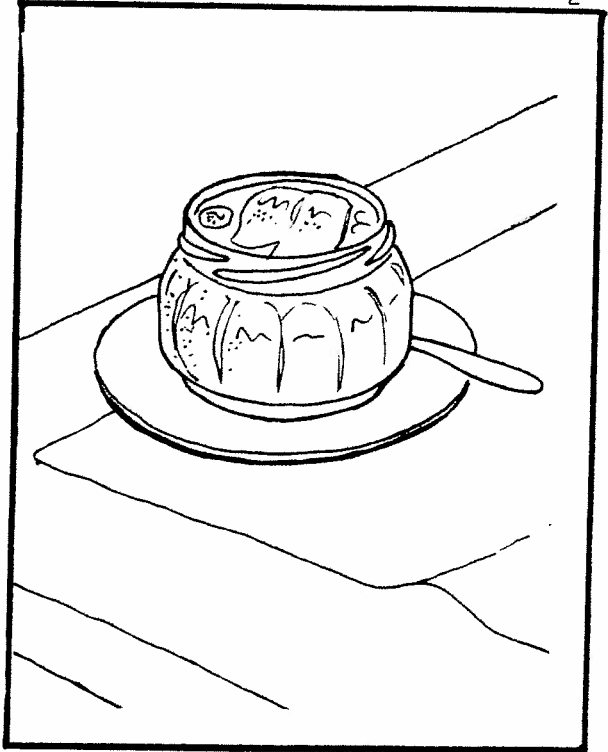

3

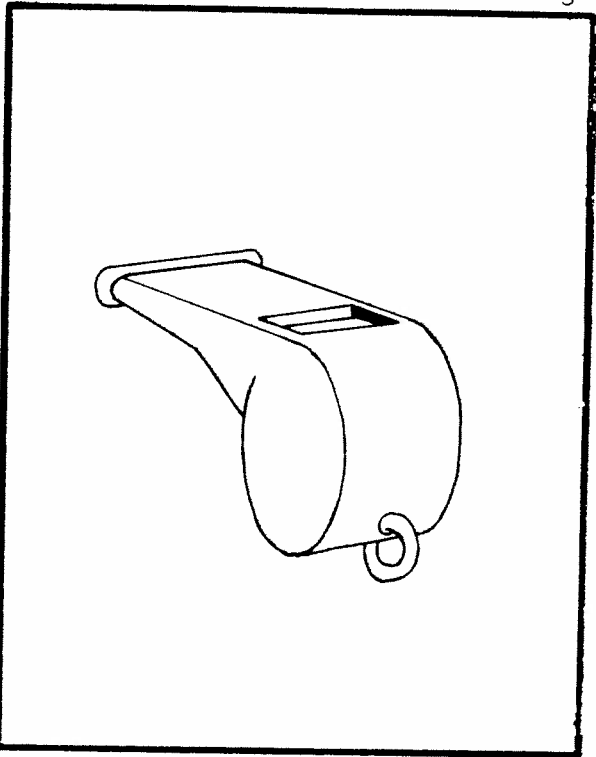

4

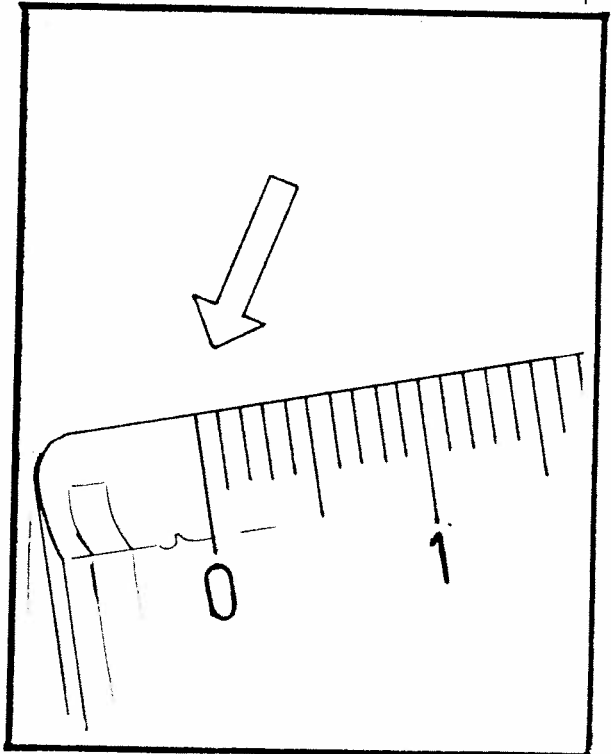

1

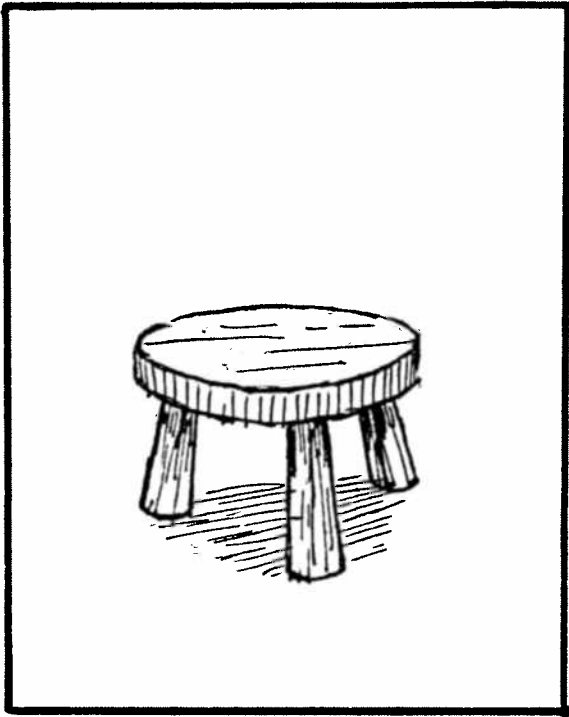

2



3

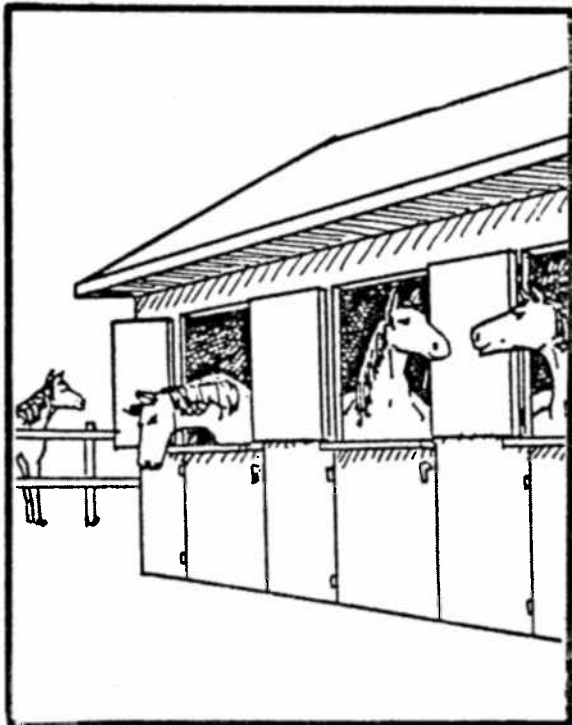

4

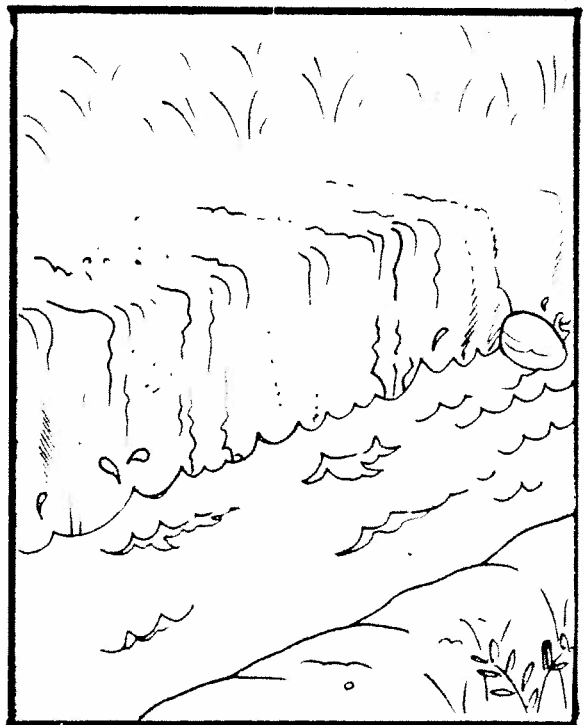

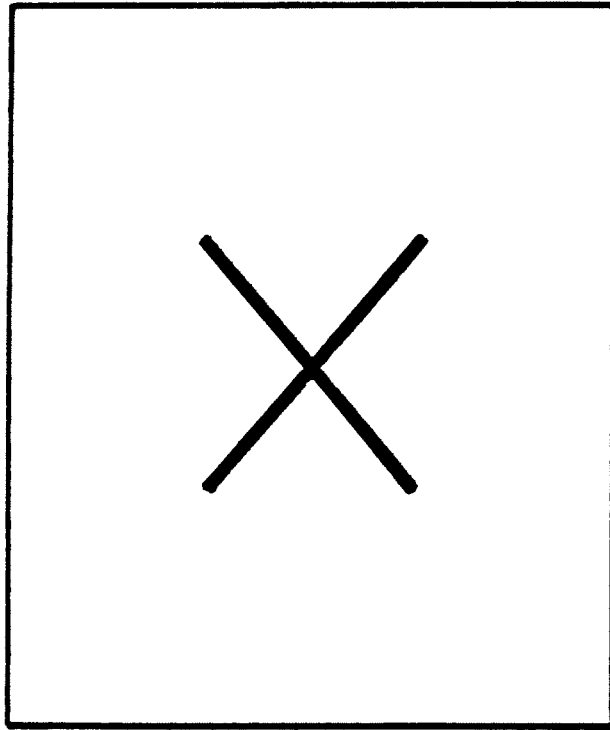

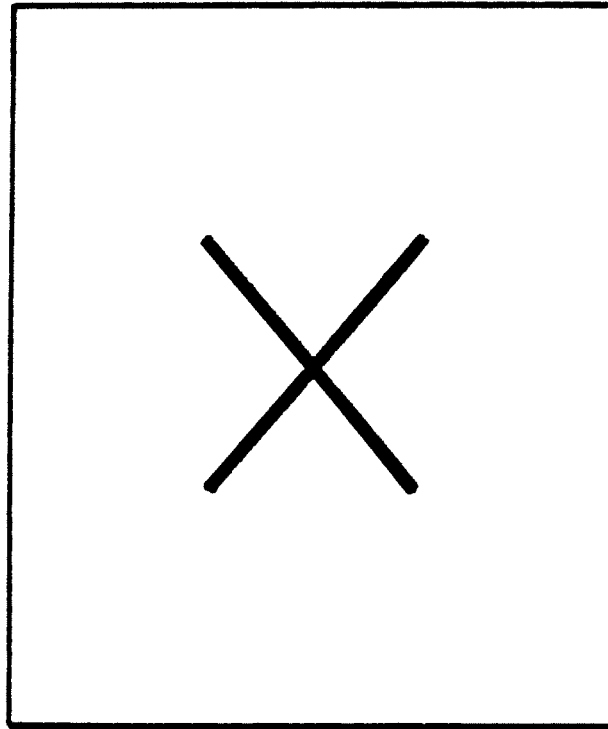



1

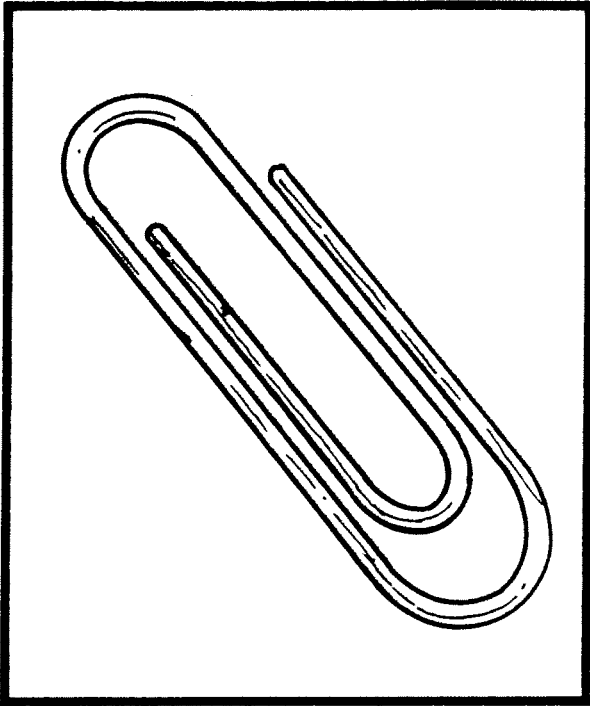

2

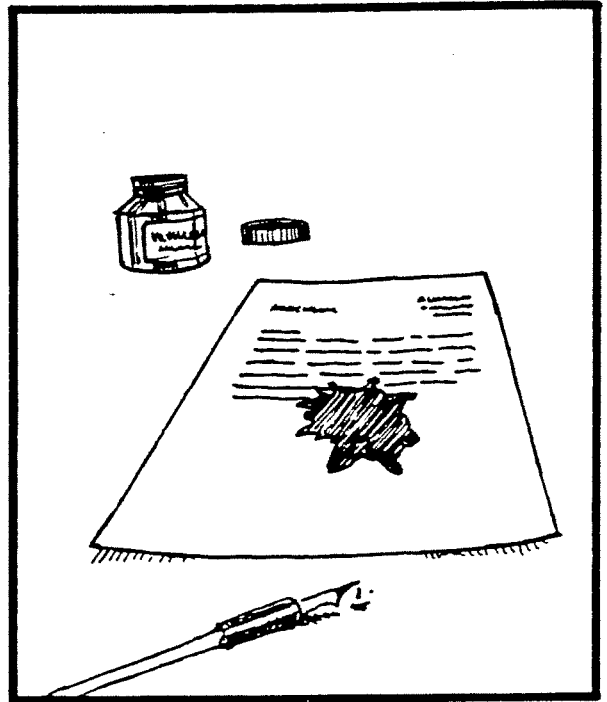

3

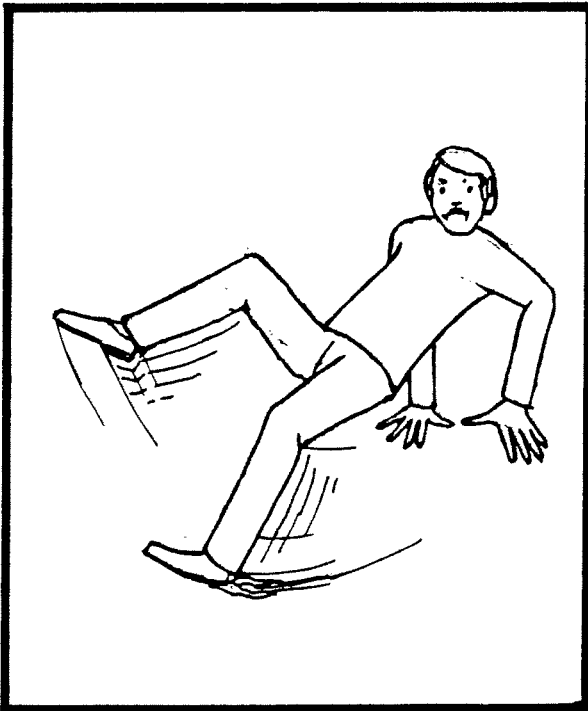

4

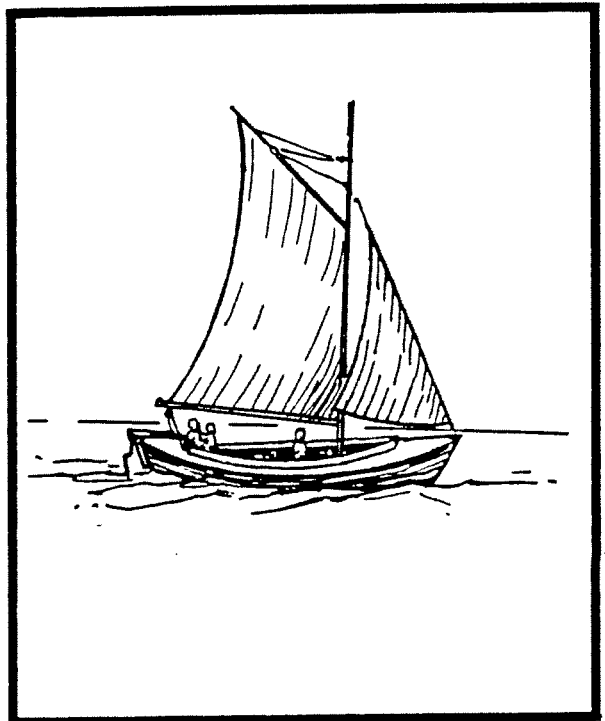

1



2

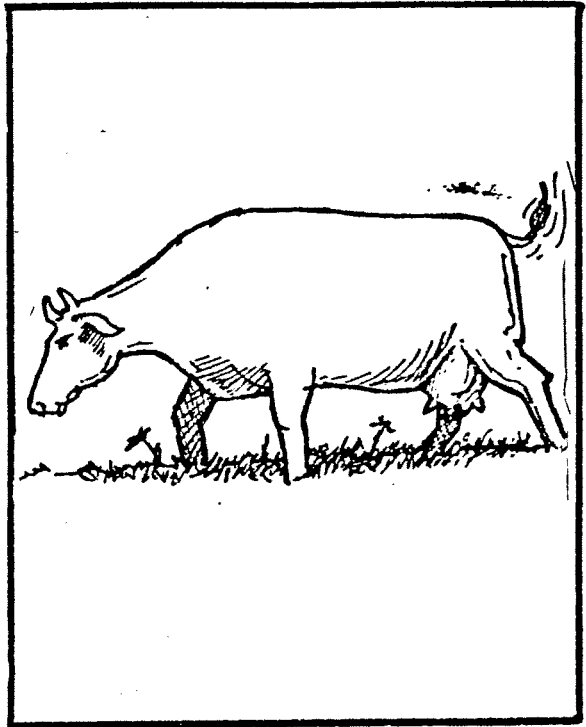

3

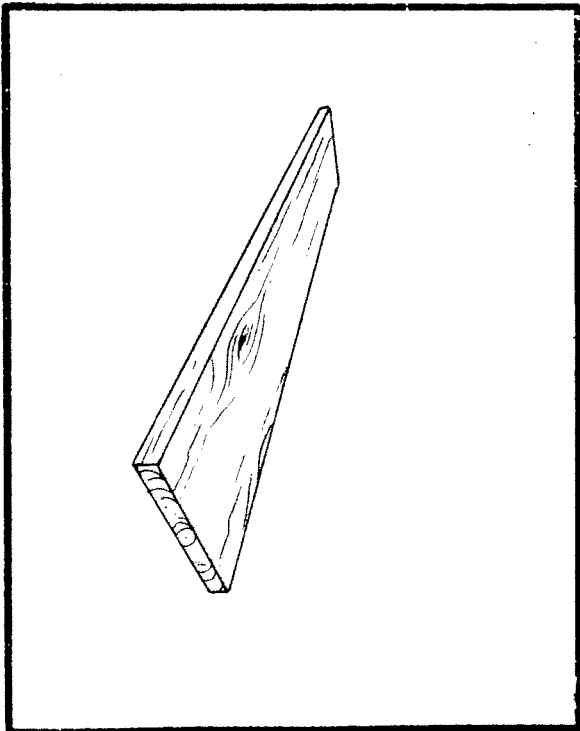

4

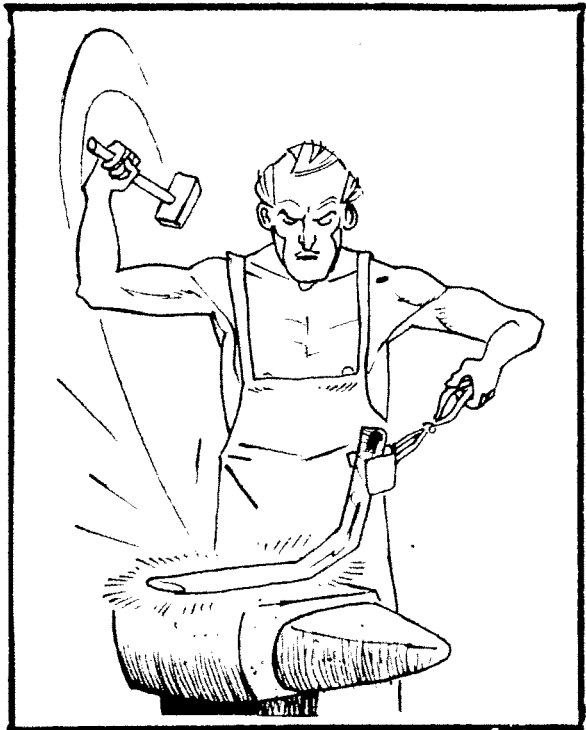

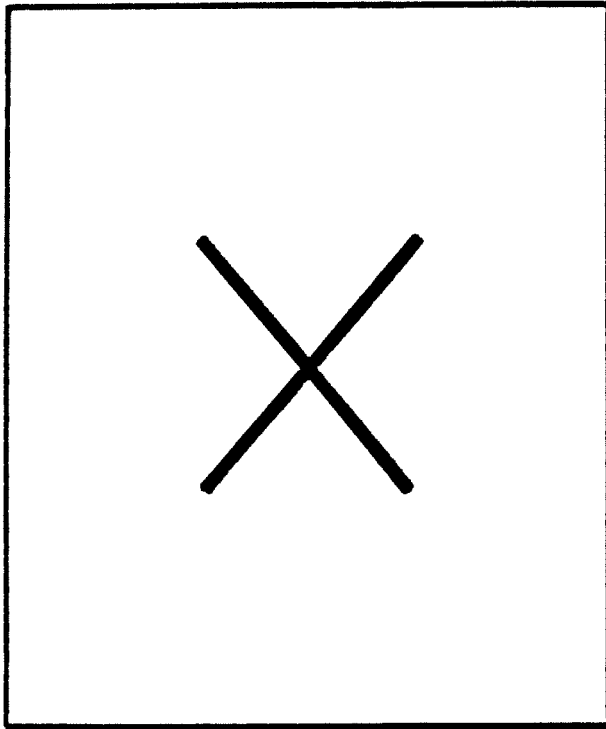

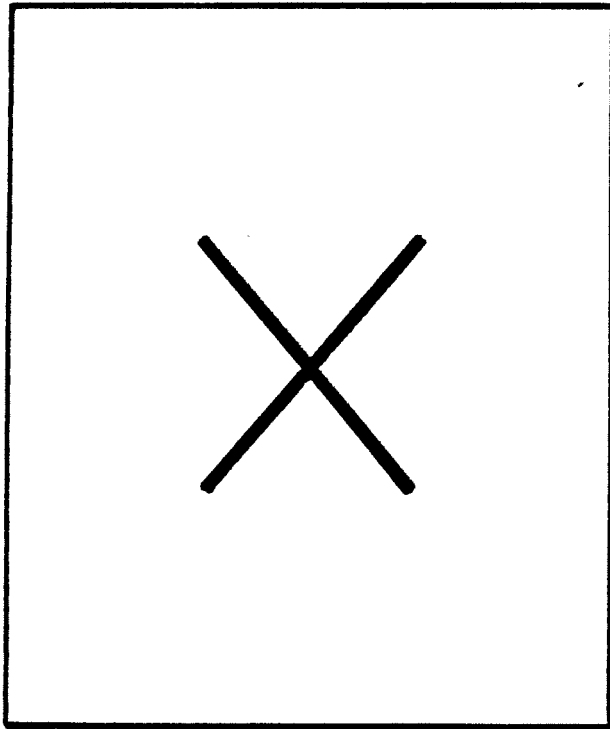

1

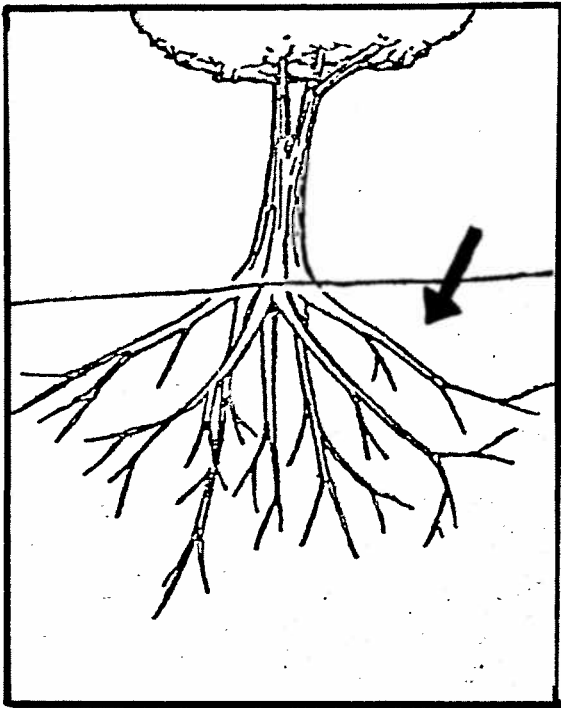

2

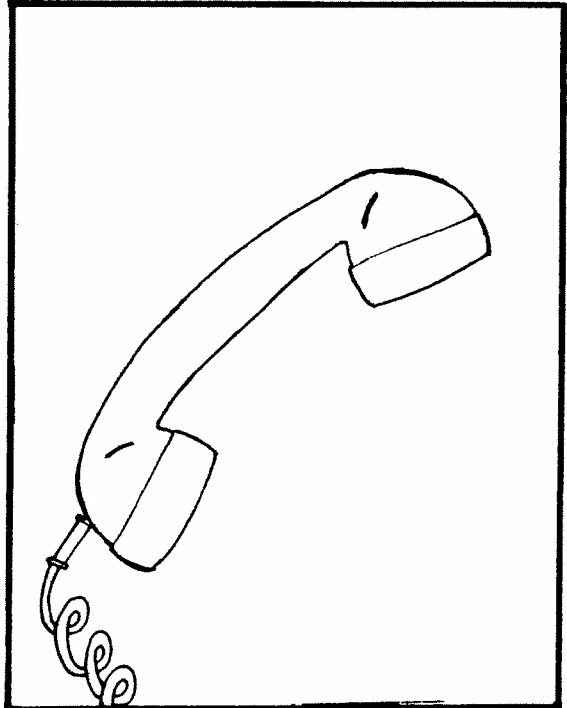

3

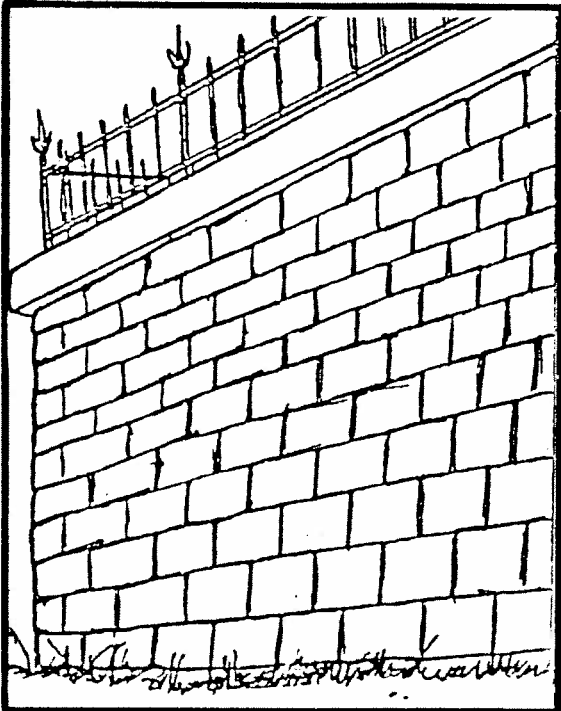

4

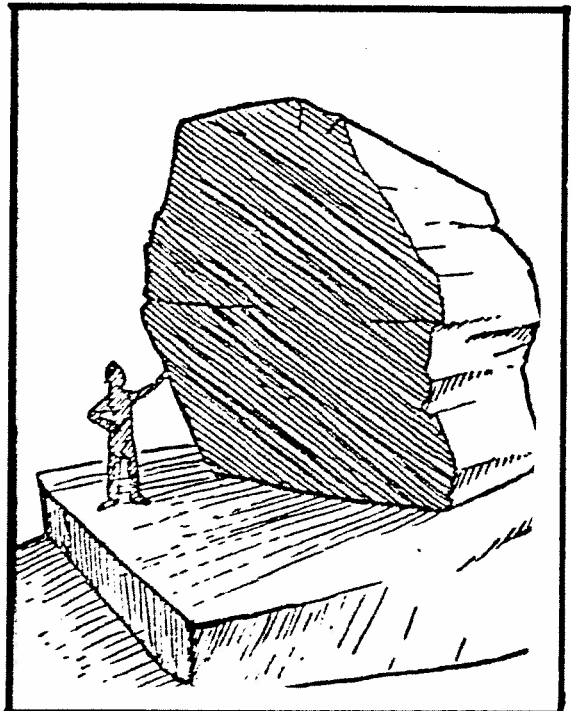

1

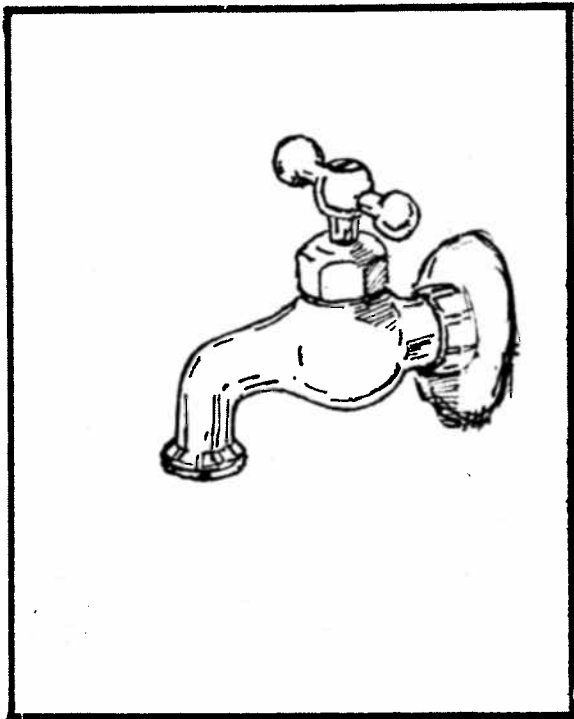

2

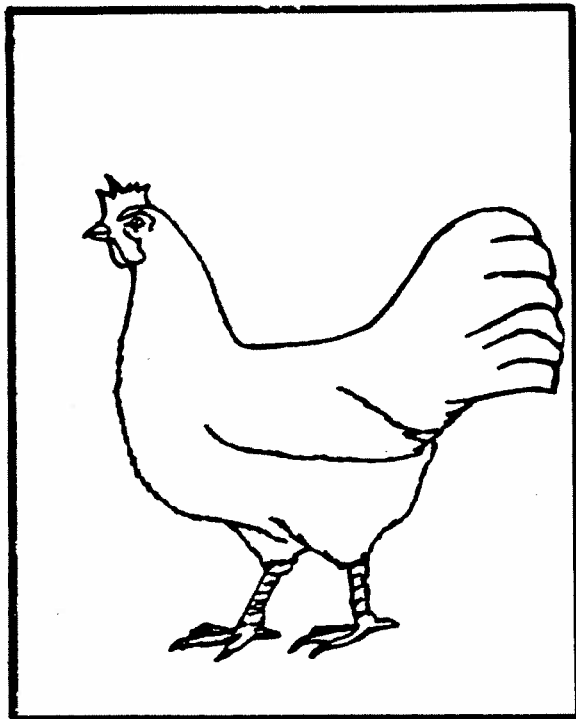

3

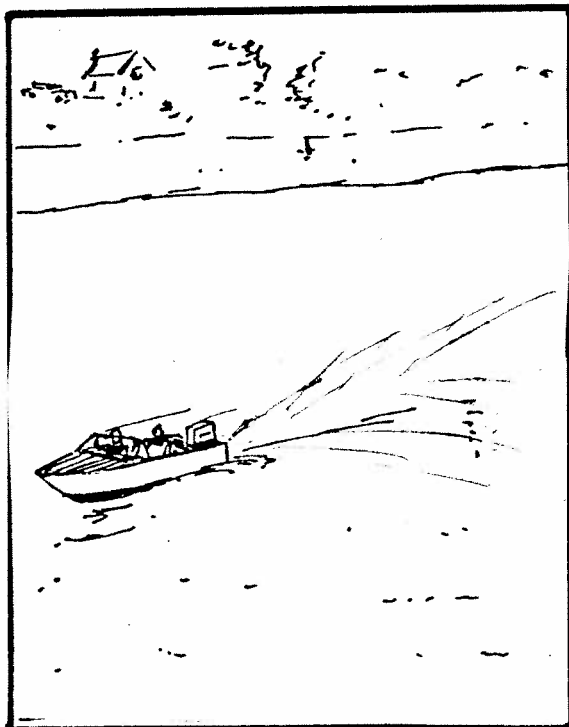

4

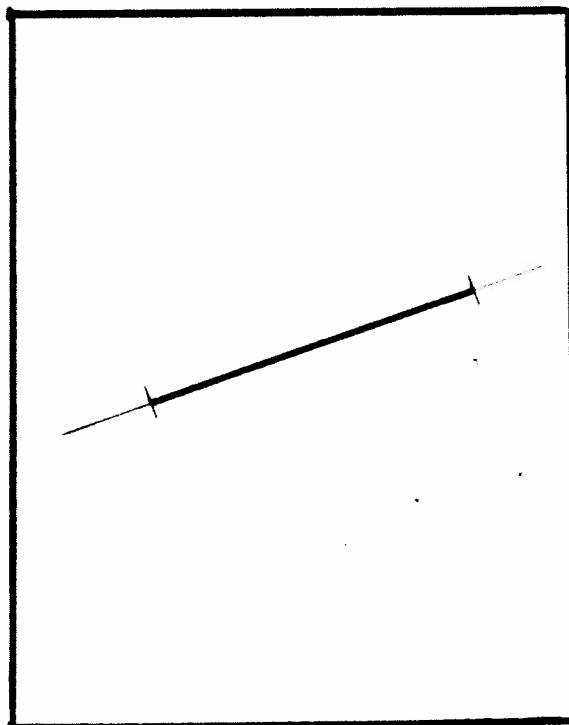

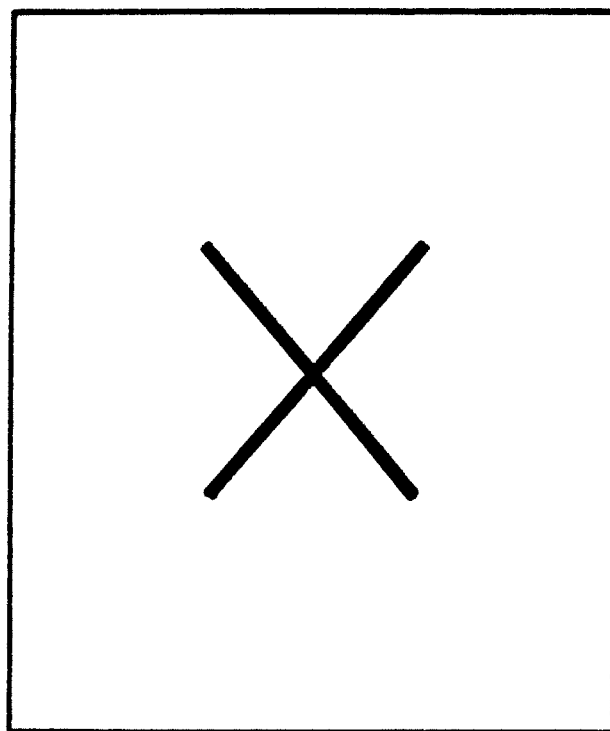

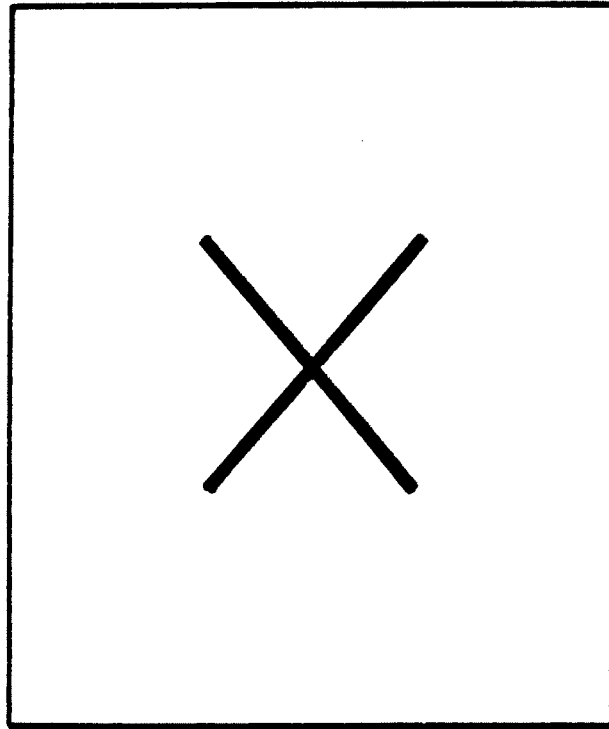



1

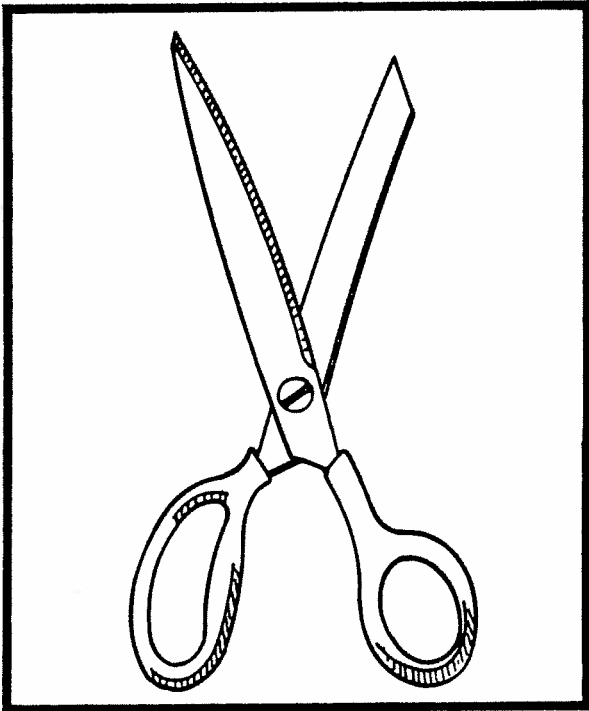

2

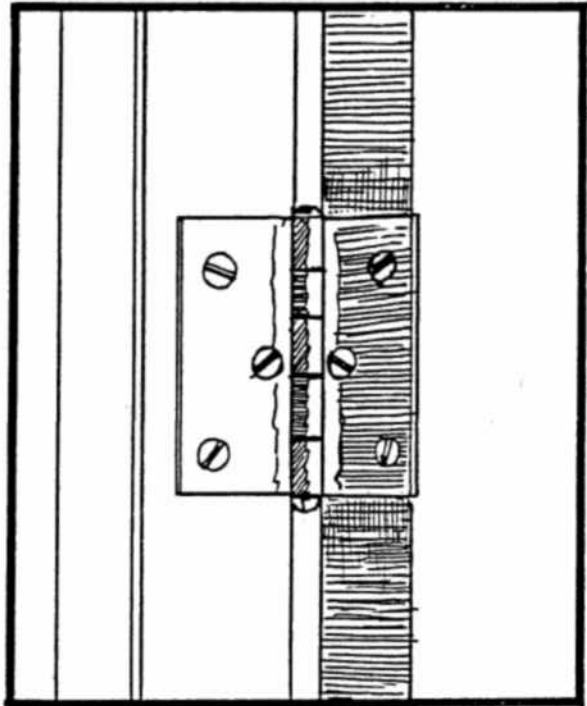

3

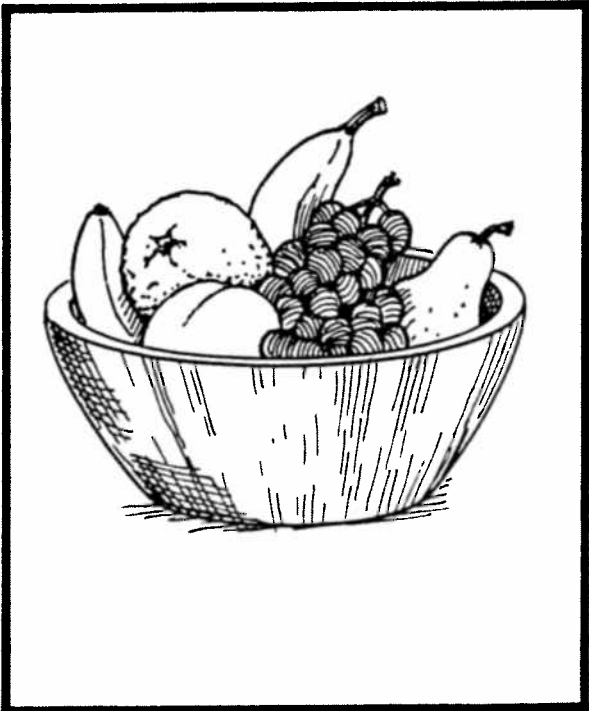

4

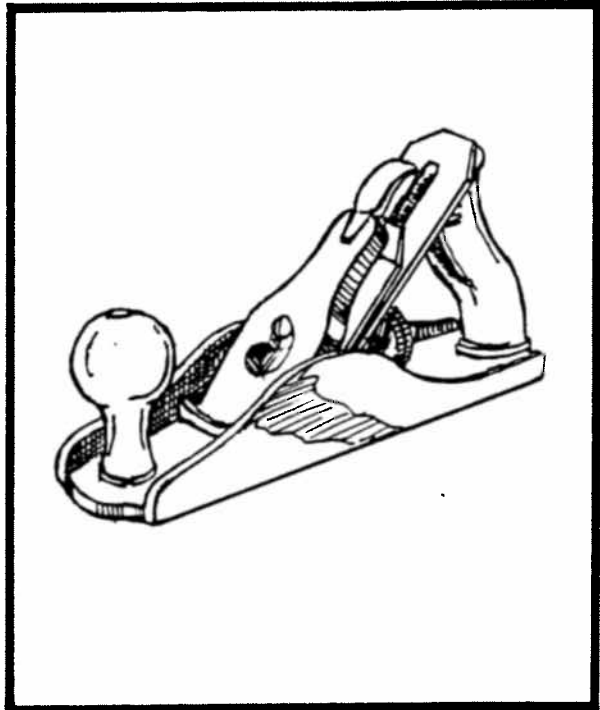

1



2

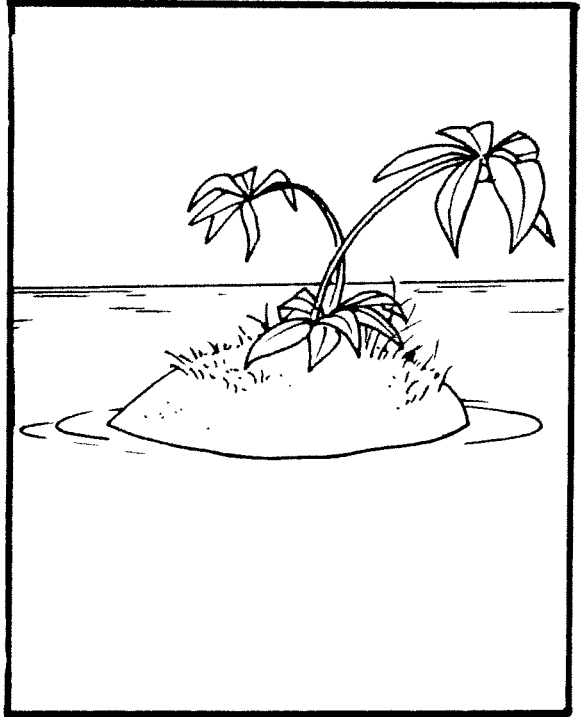

3

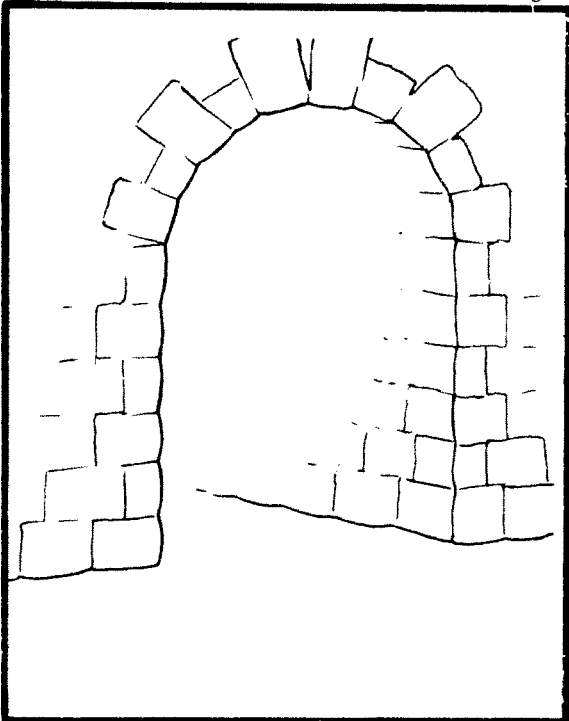

4

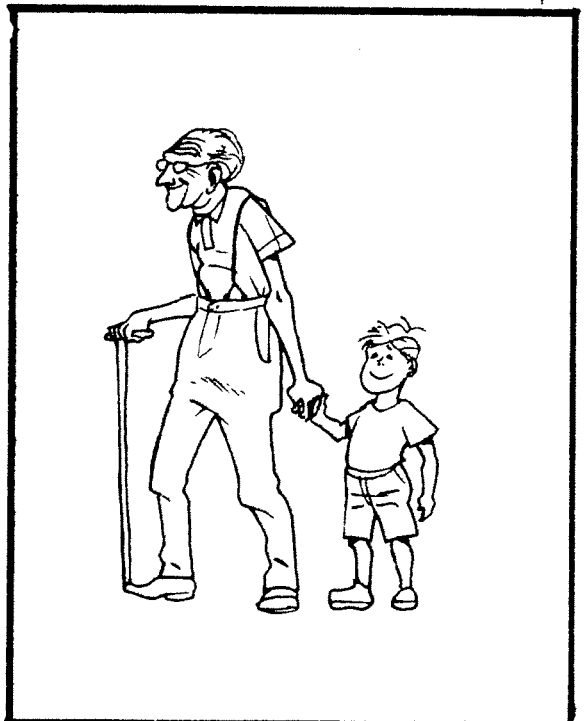

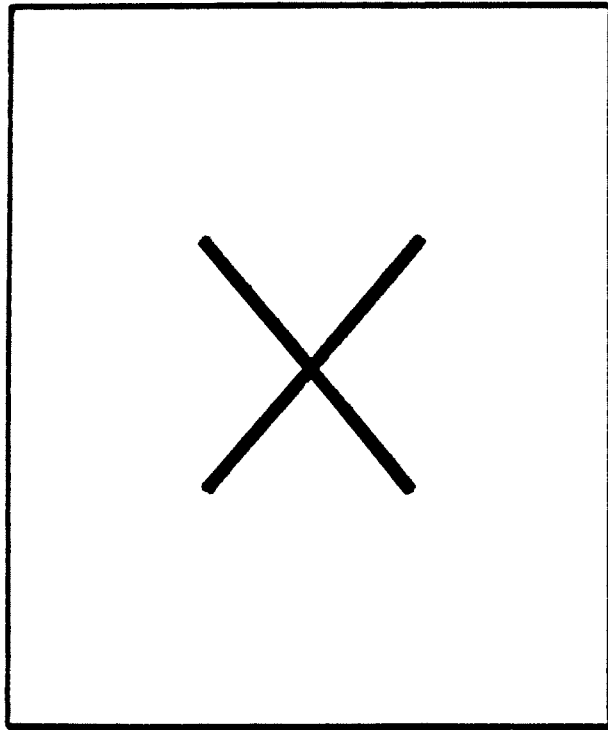

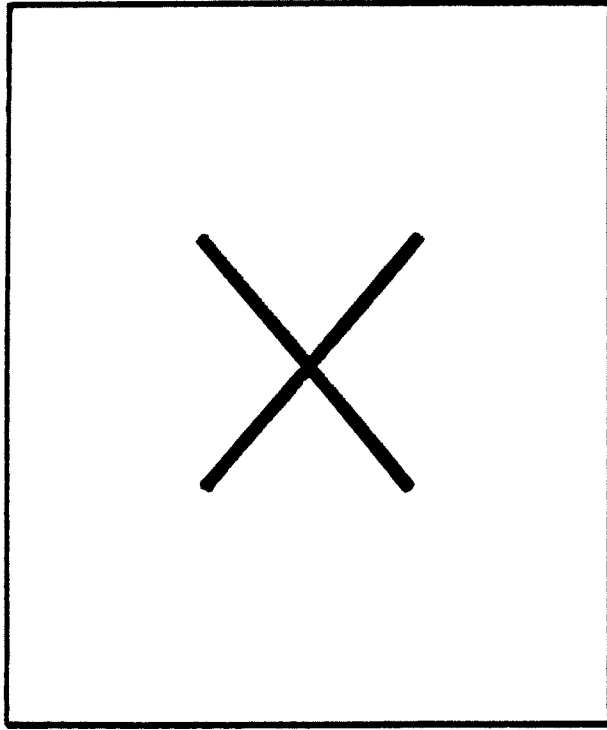

1

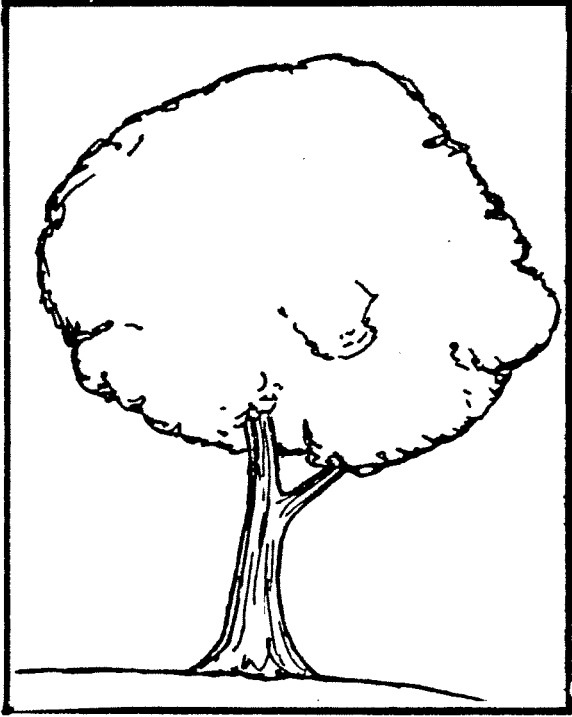

2



3

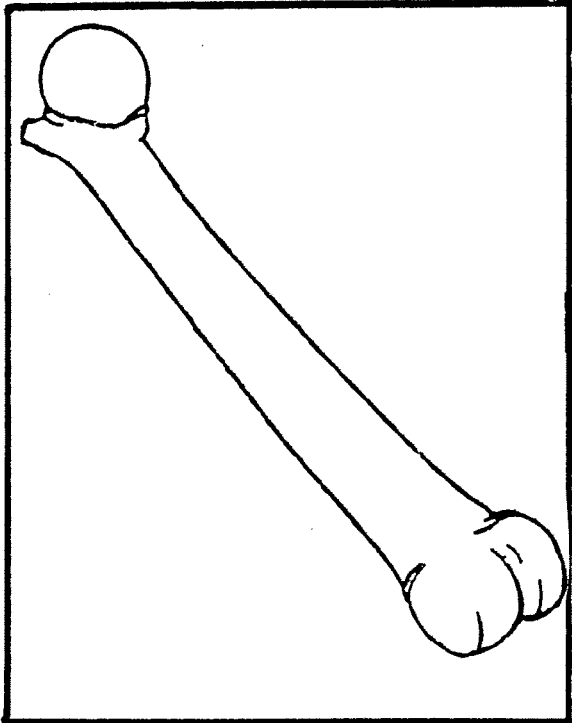

4

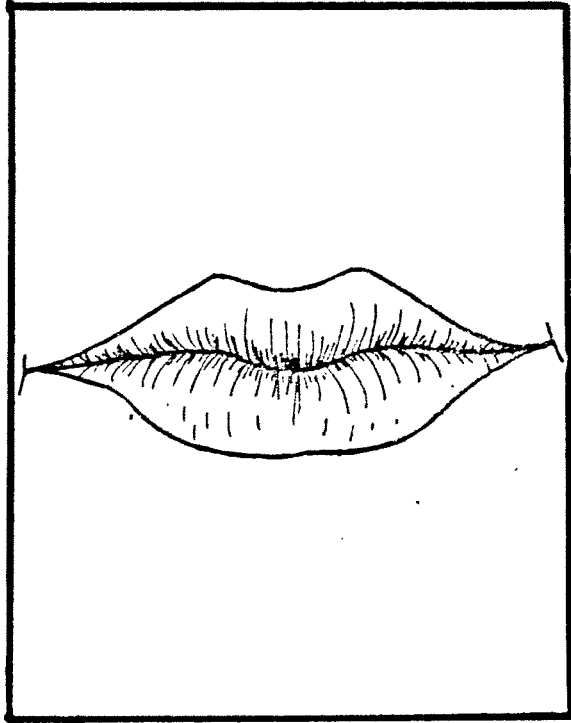

1

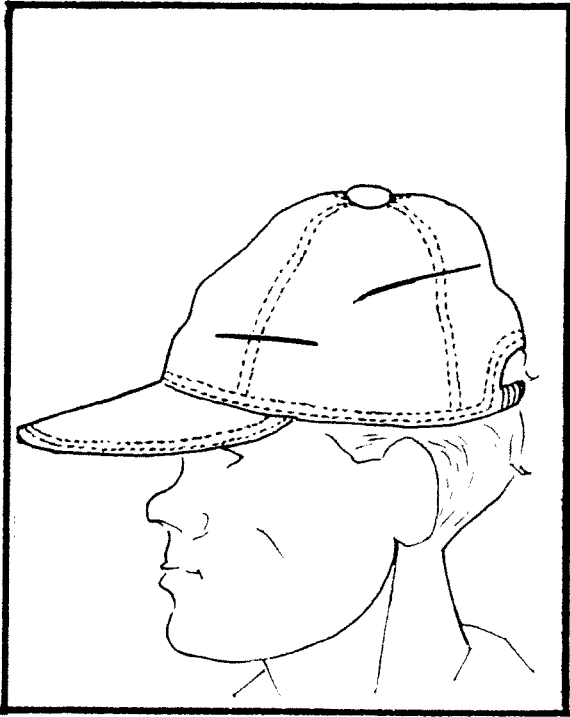

2

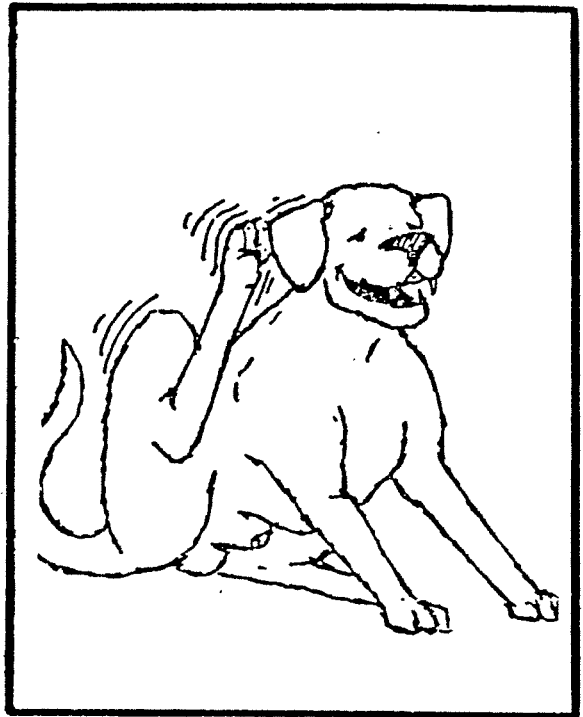

3

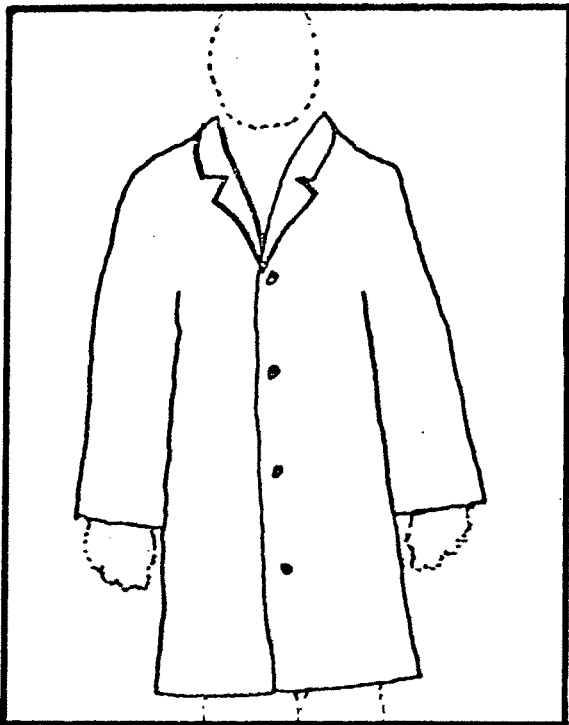

4

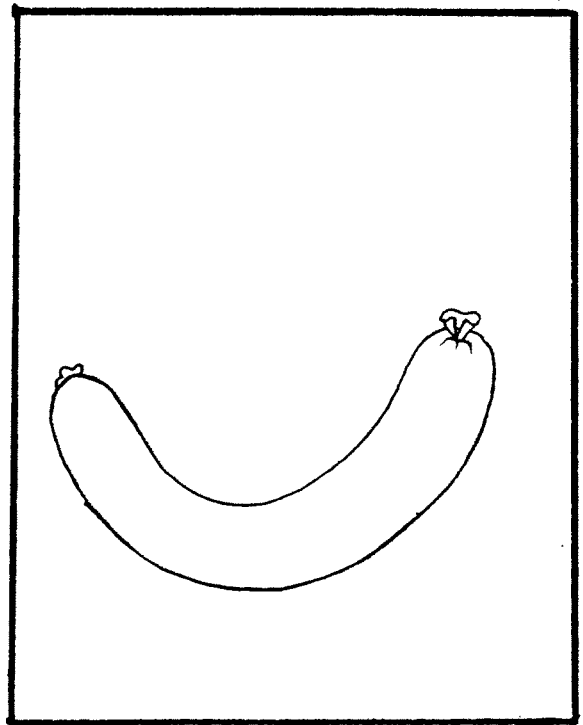

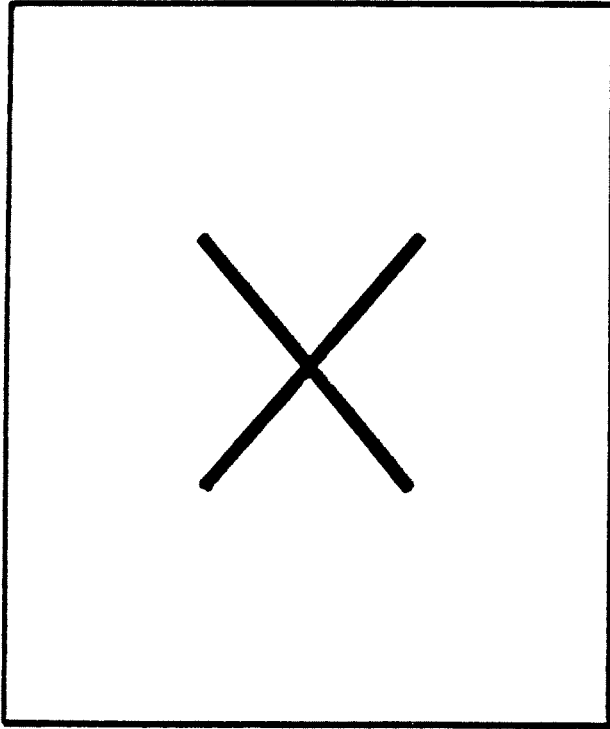

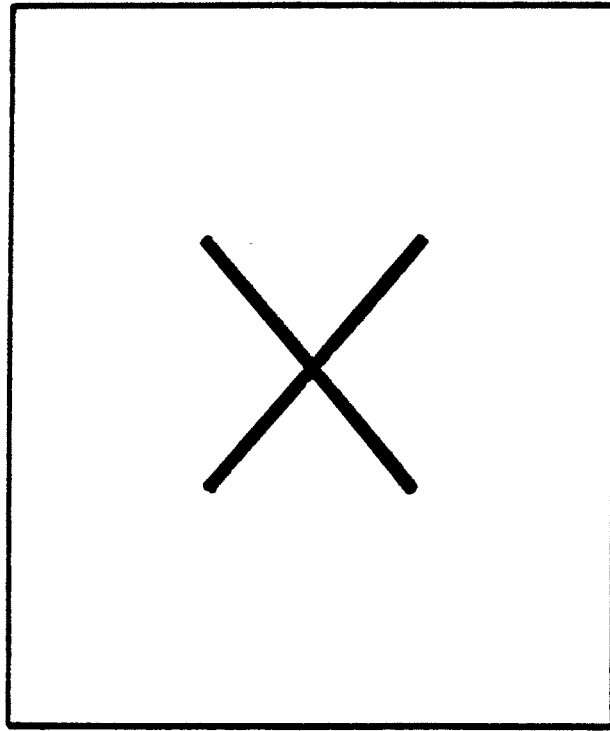



1

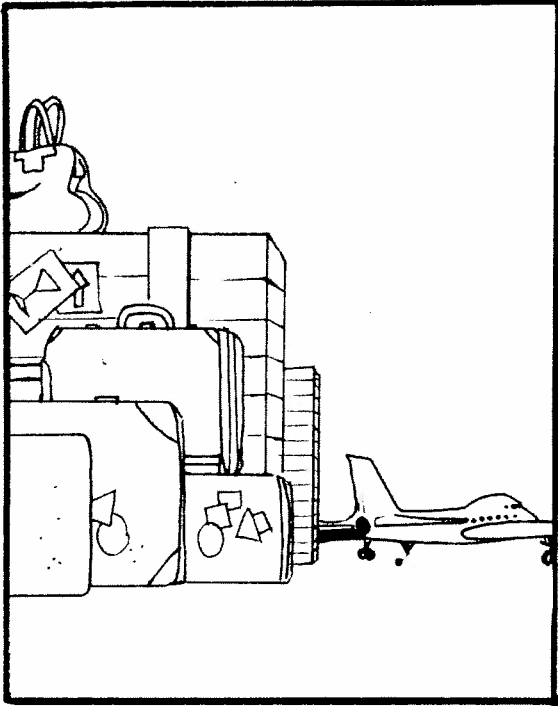

2

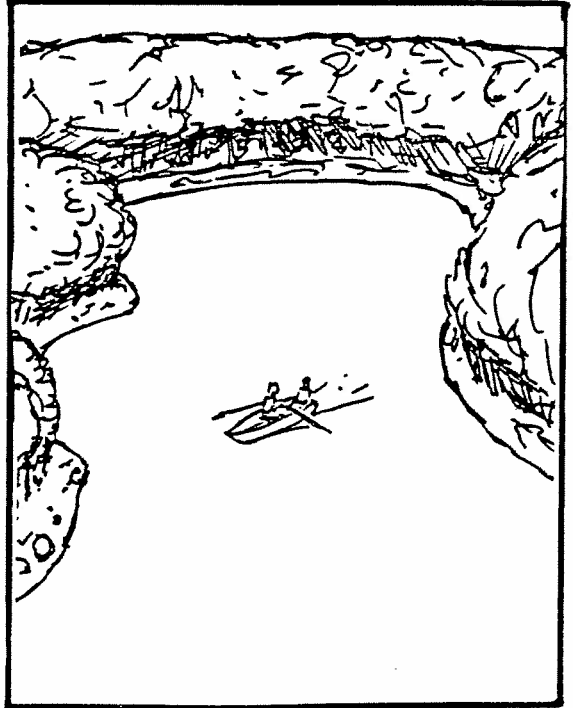

3

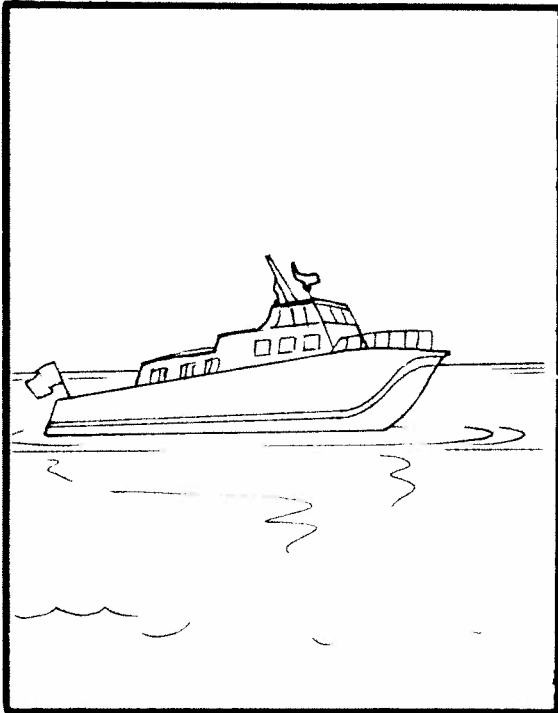

4





# SYNTAKTISTEN RAKENTEIDEN YMMÄRTÄMINEN

1

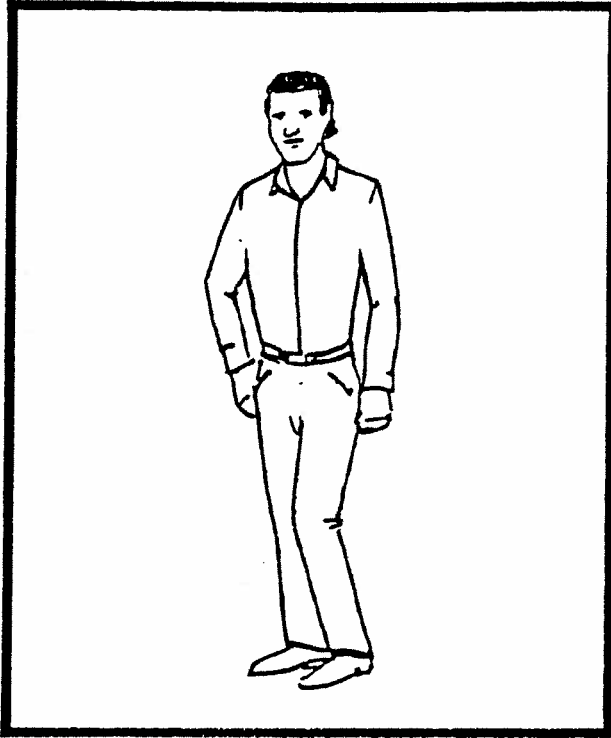

2

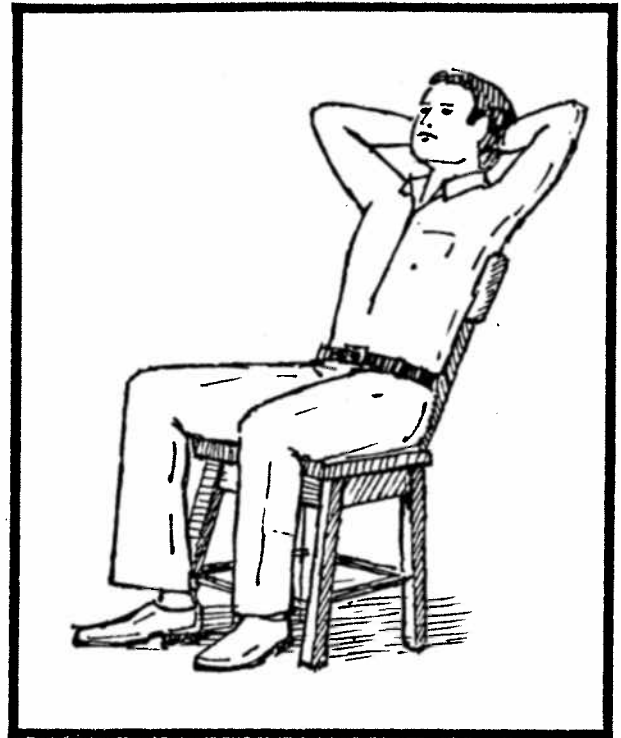

3

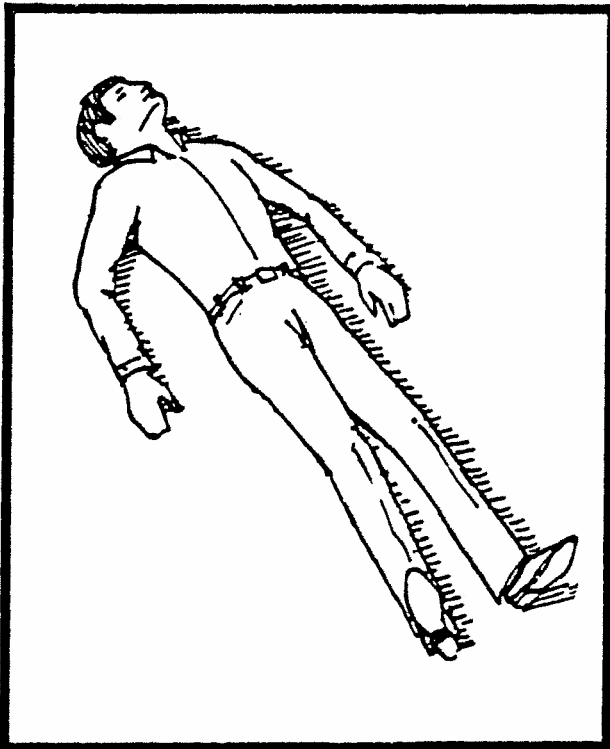

4



Esimerkki

1



2



3



4



1

1



2

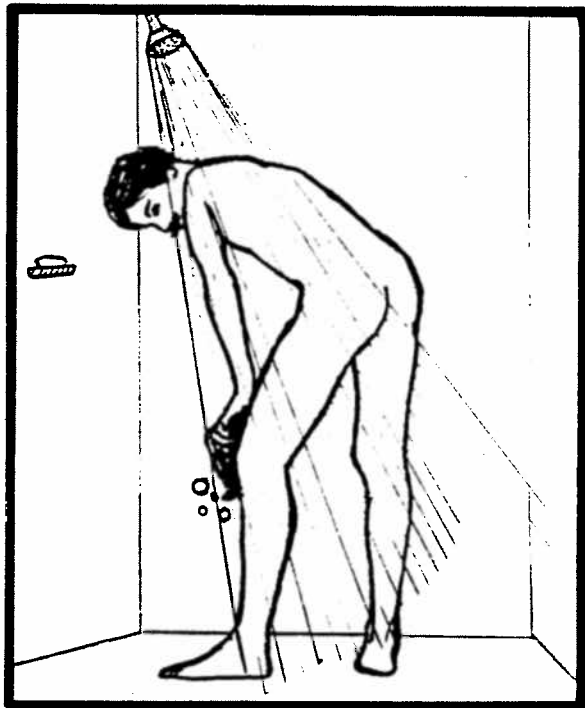

3

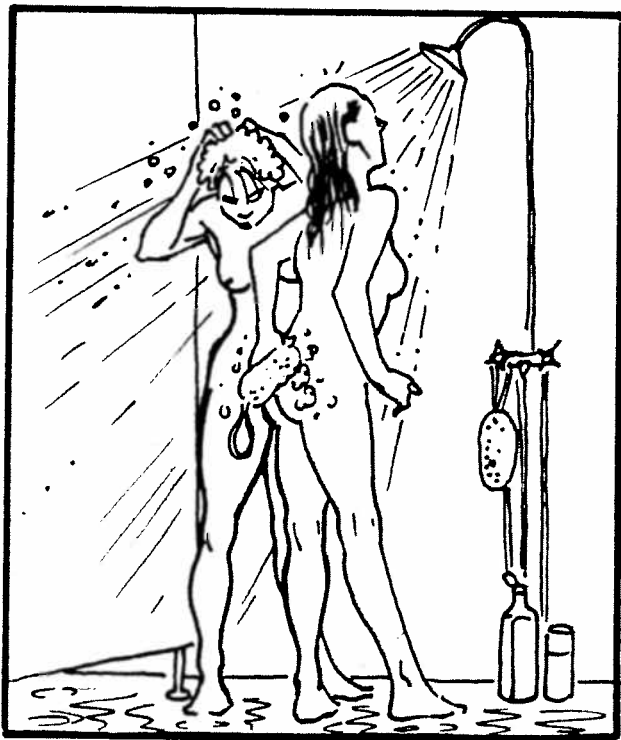

4



2

1

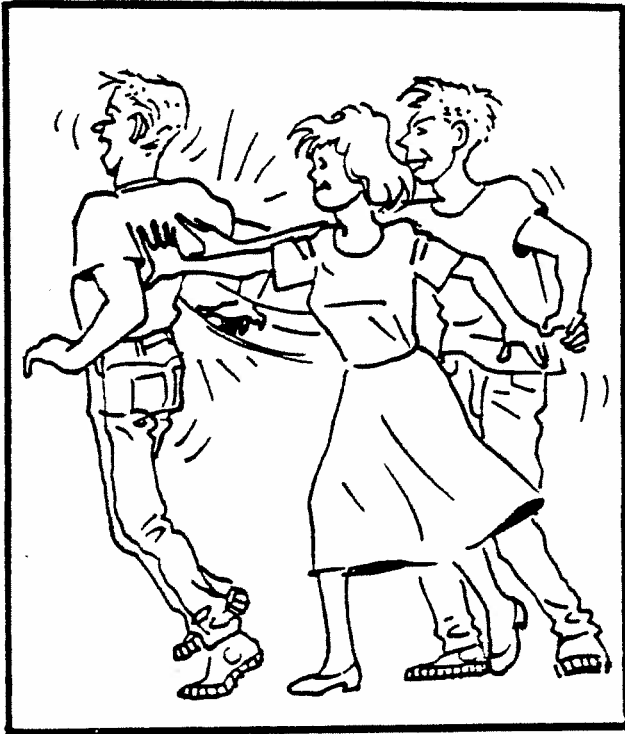

2



3

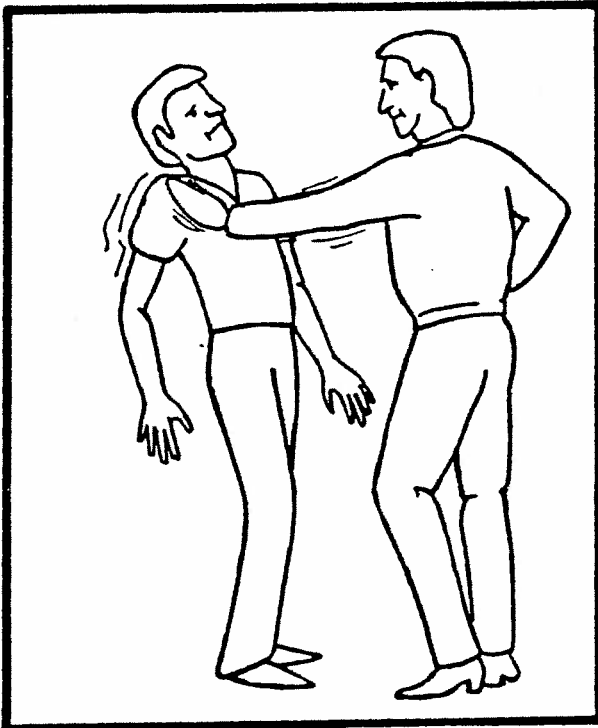

4



3

1

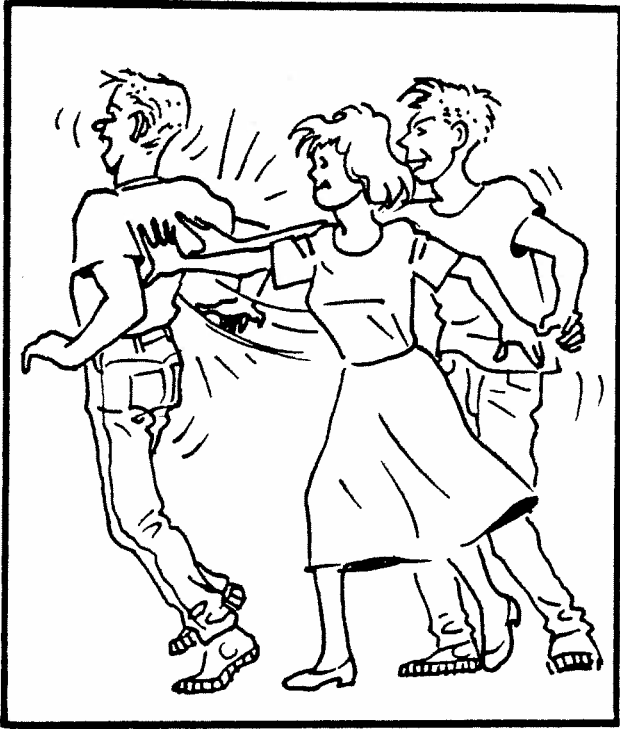

2



3



4

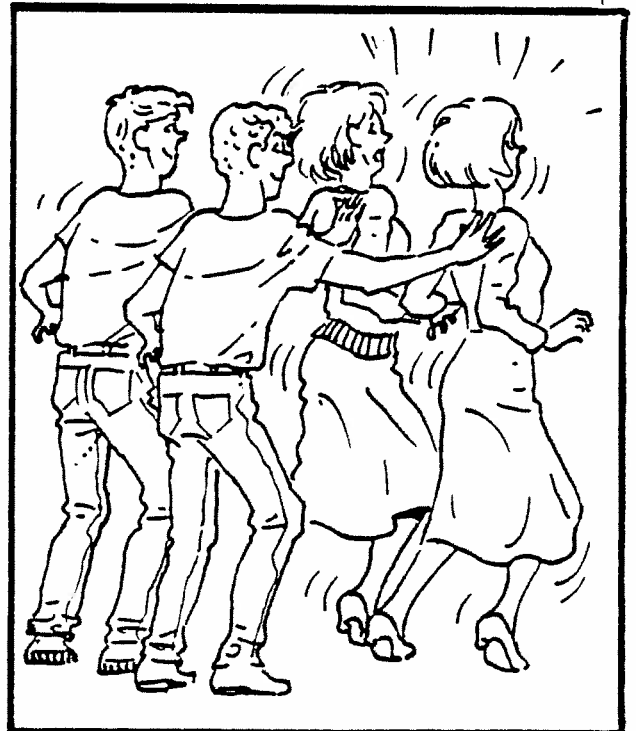

4



1

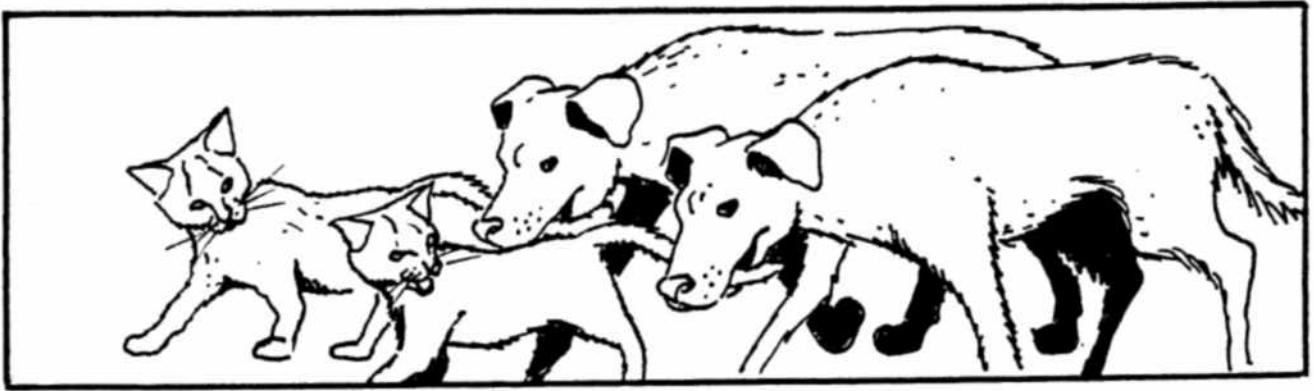

2

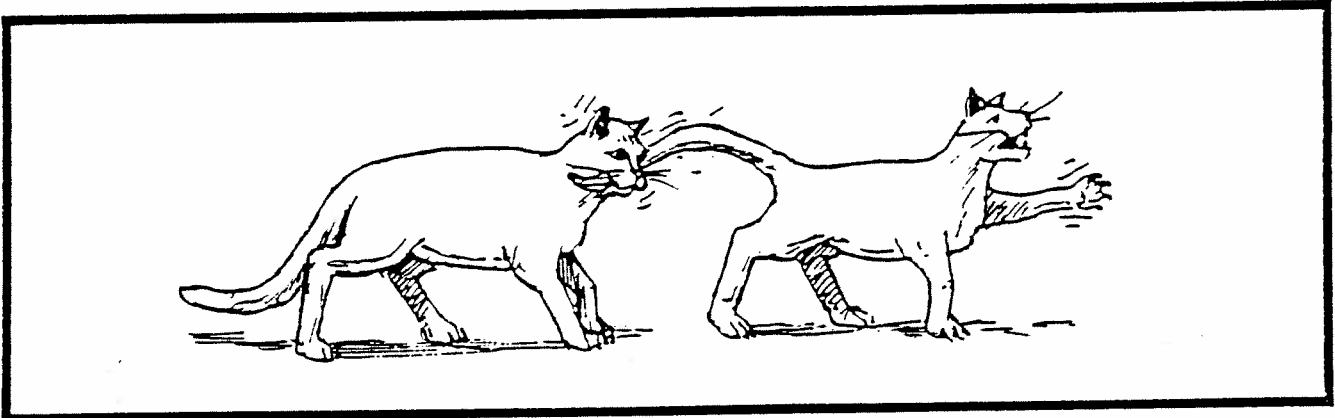

3



4

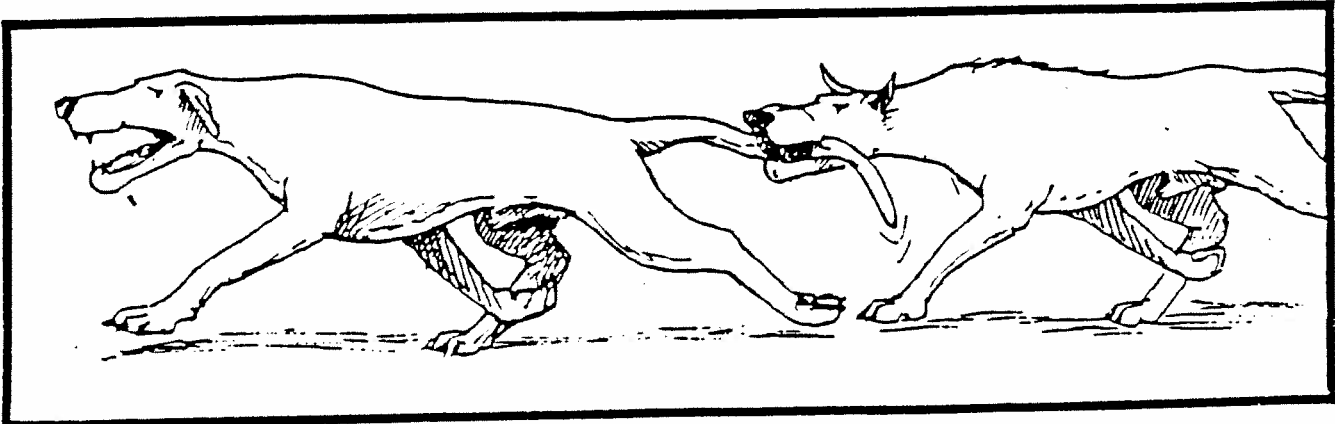

1



2

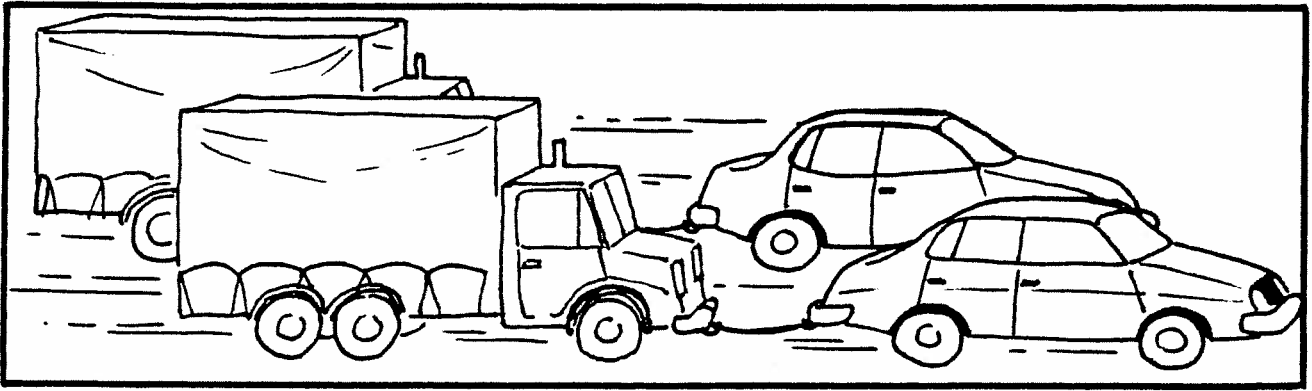

3

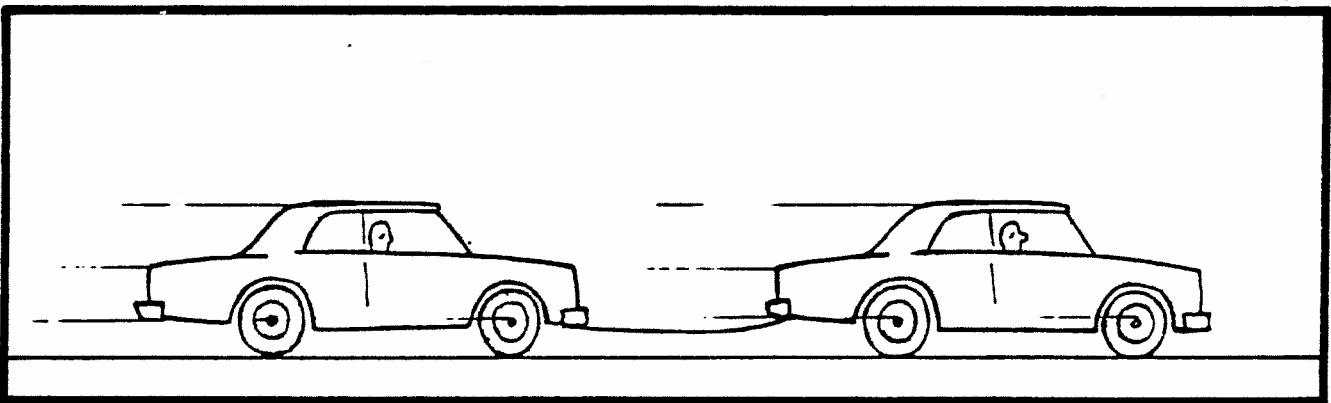

4

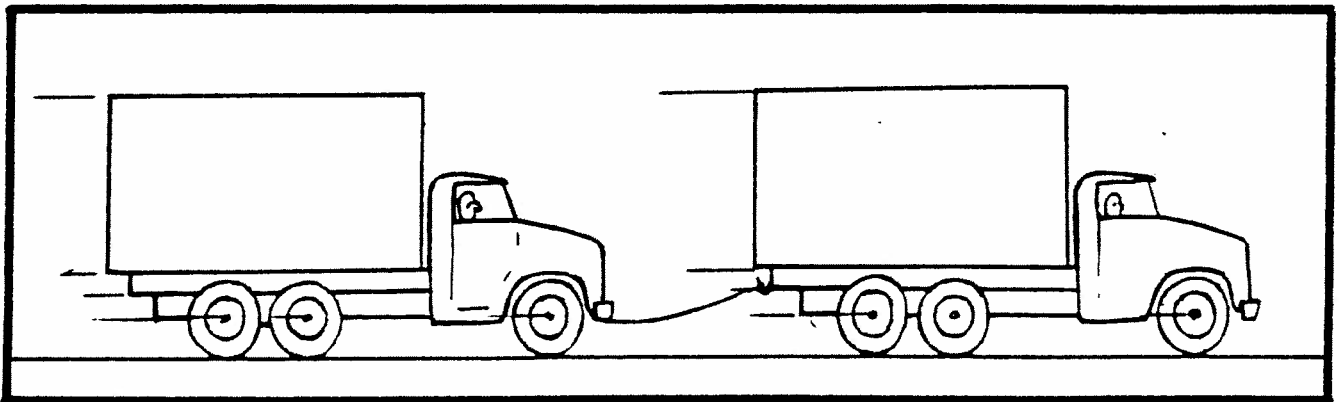

6

1



2



3

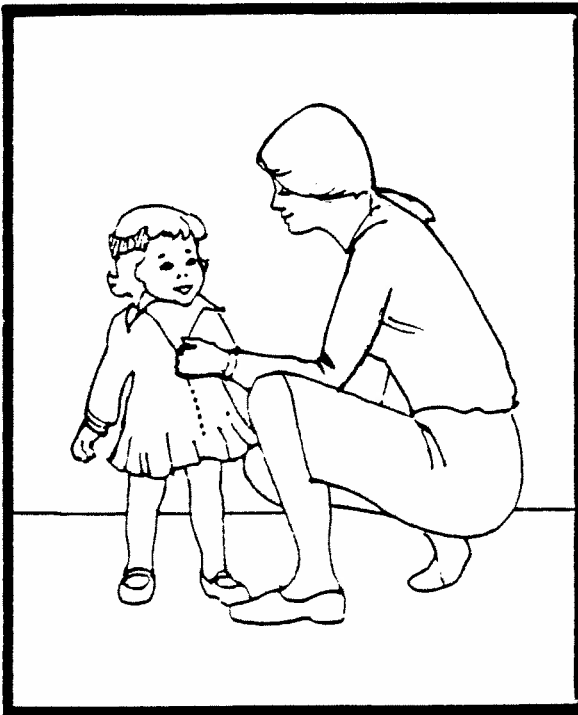

4

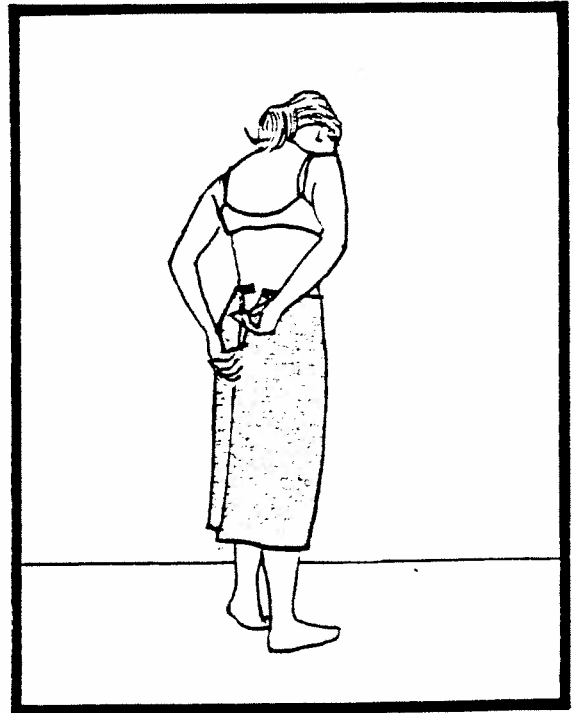

7

1



2



8

1

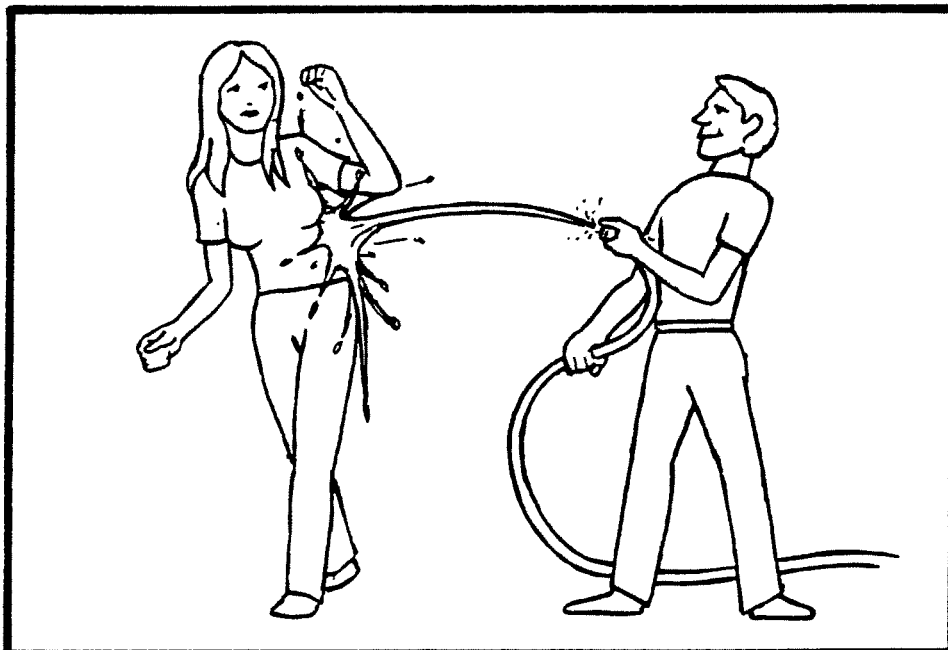

2

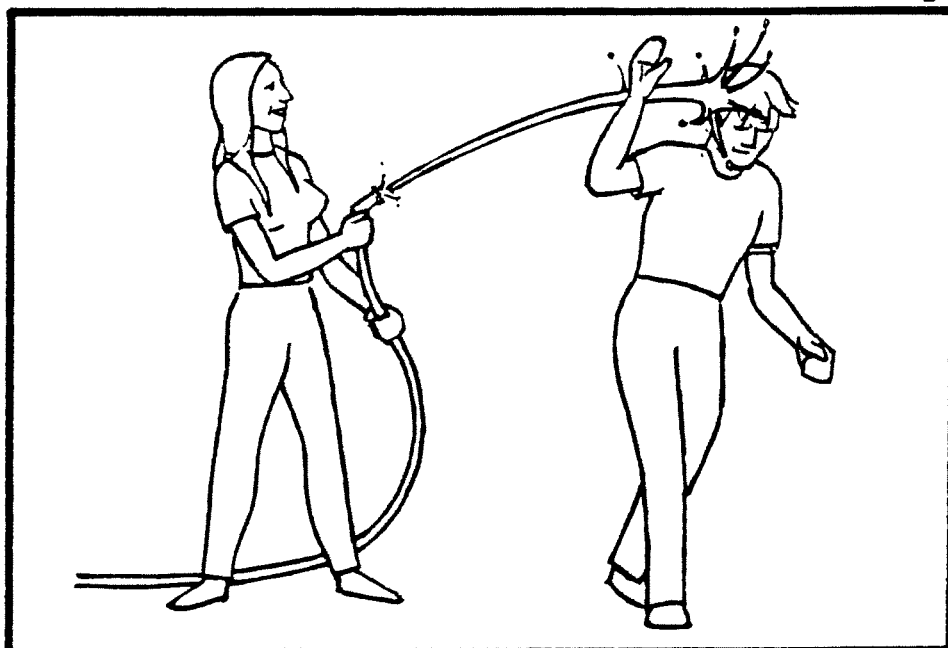

1

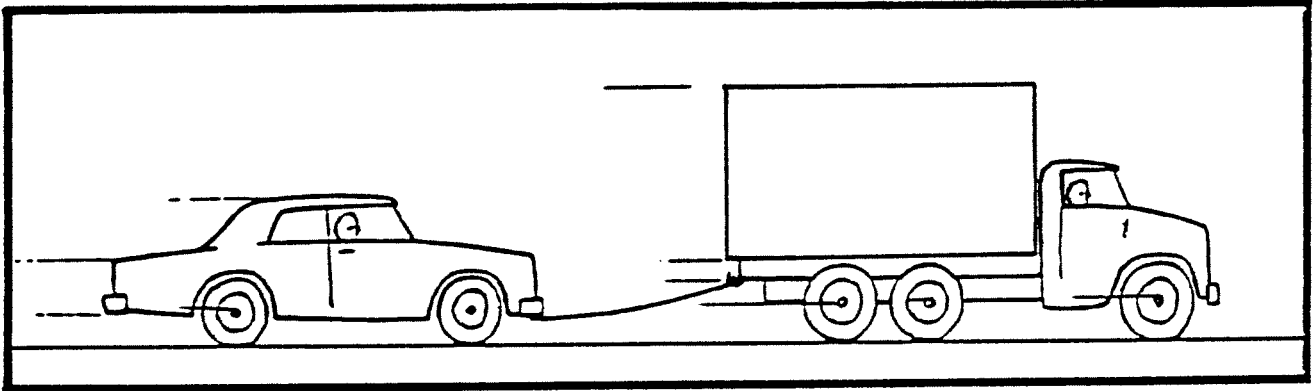

2

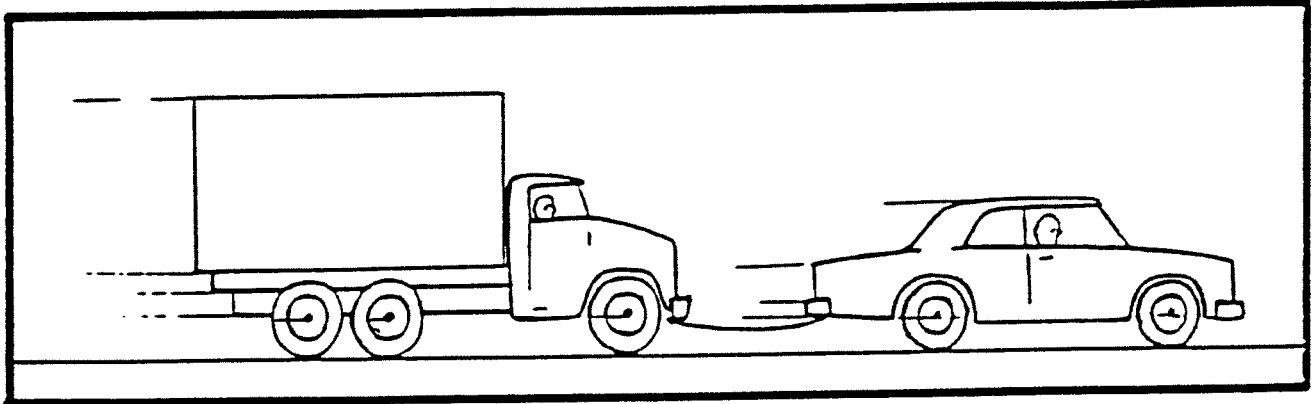

10

1



2

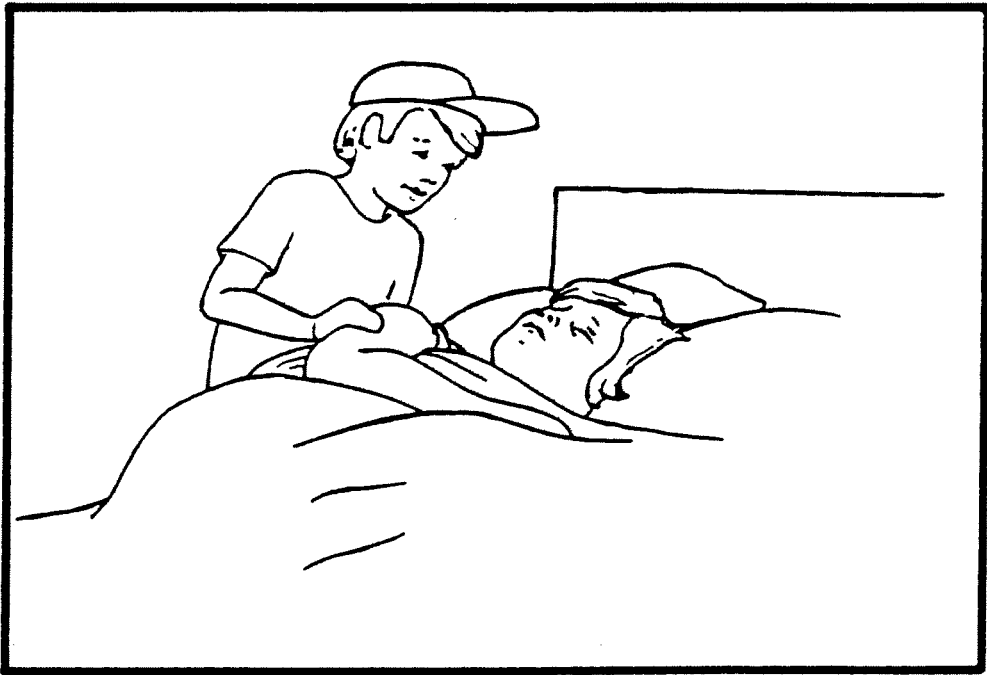

1

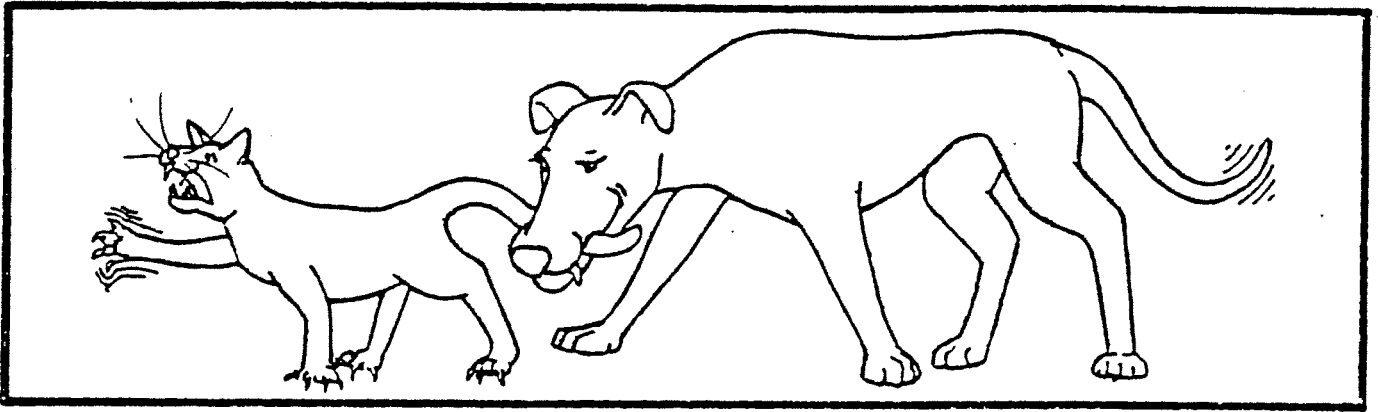

2

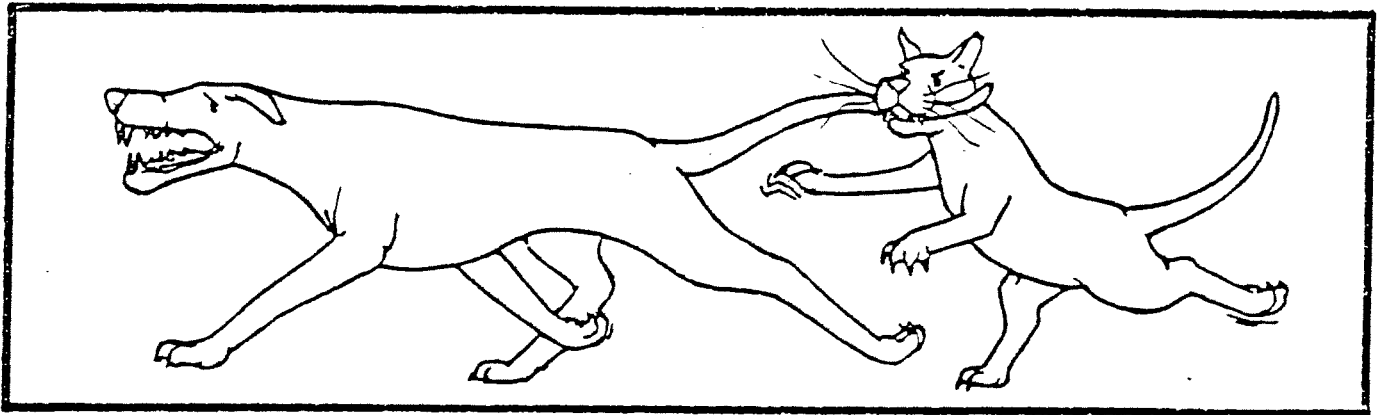

12



1

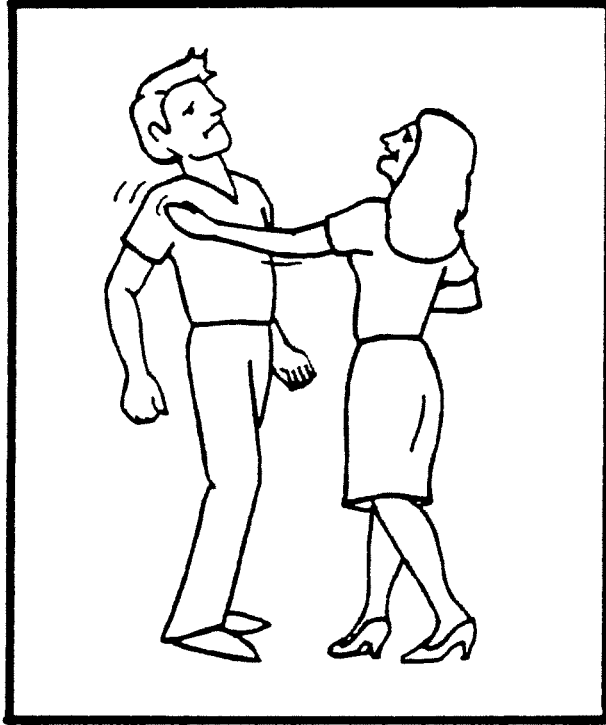

2

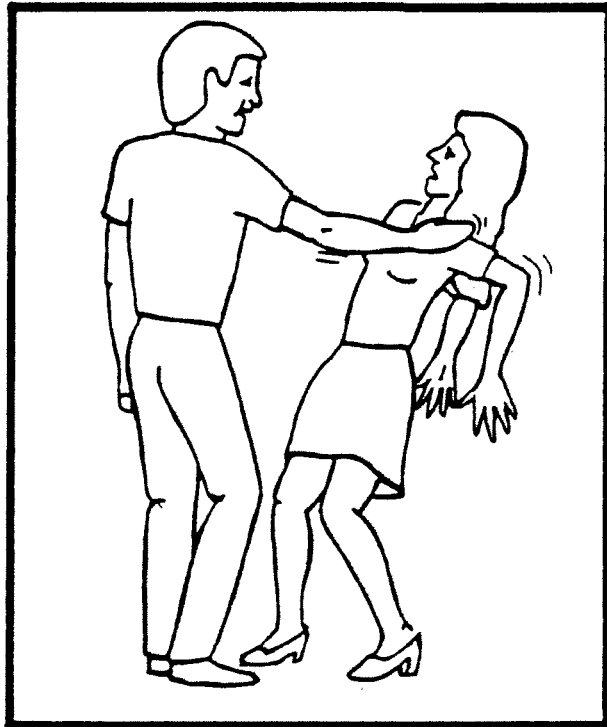

1

2



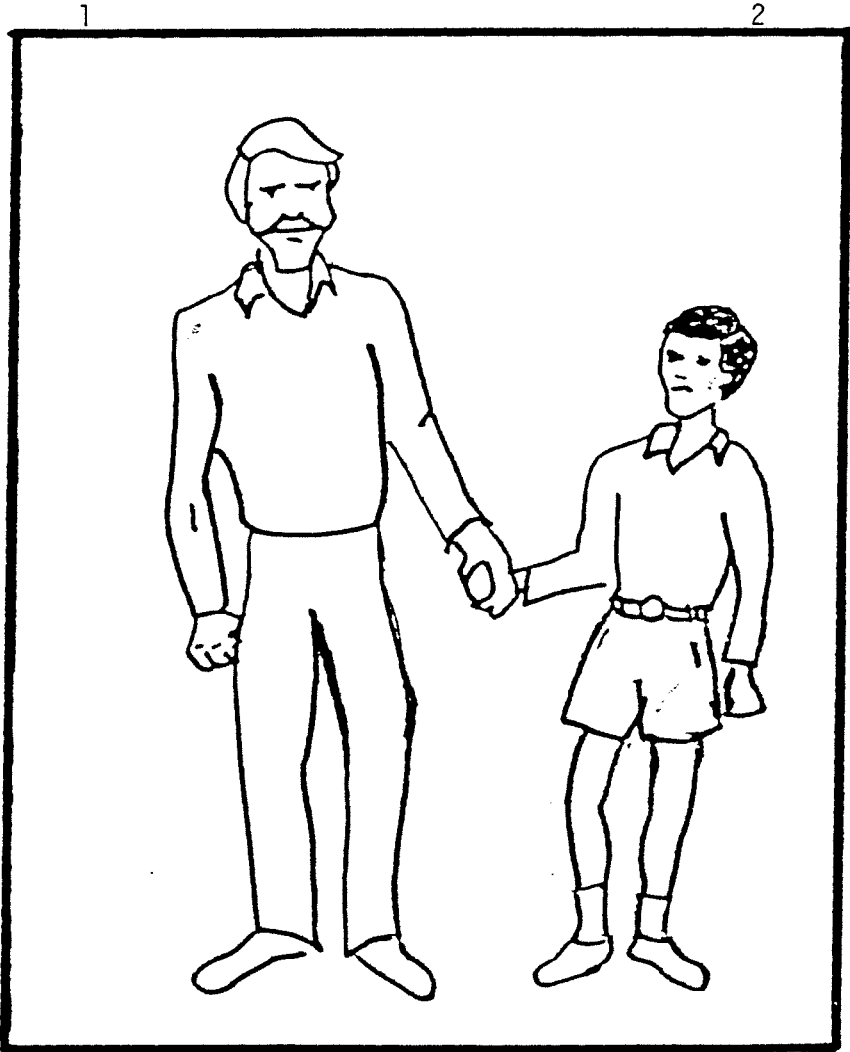

1

2

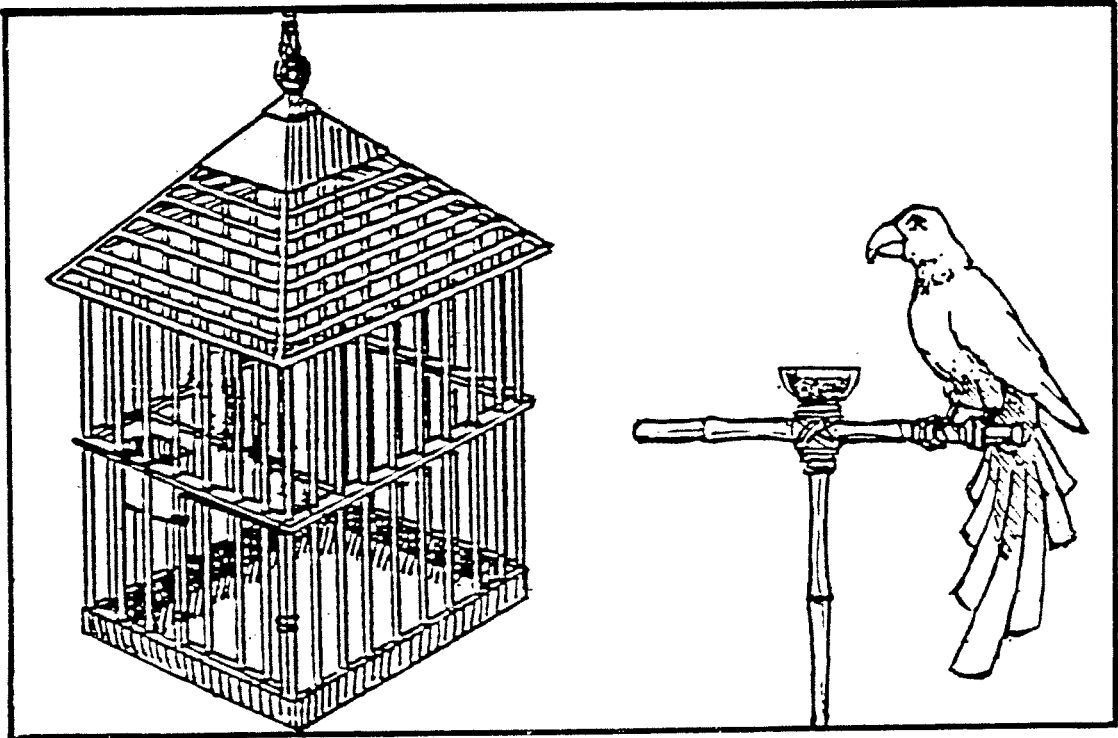

1

2

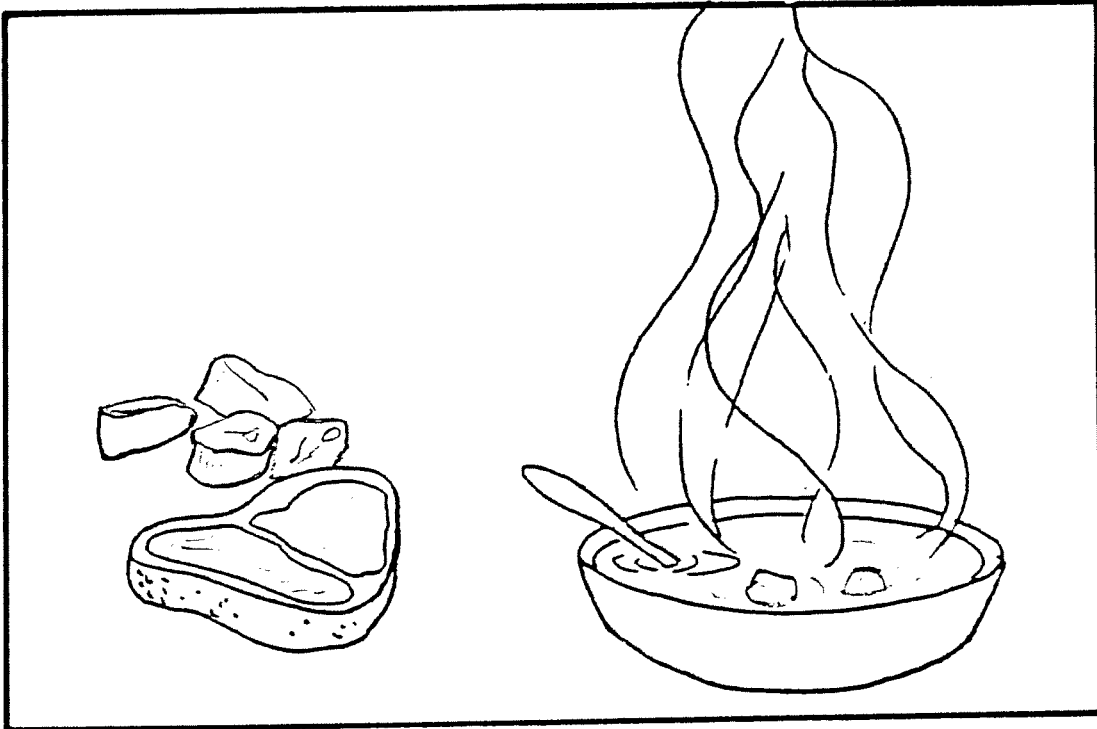

1

2

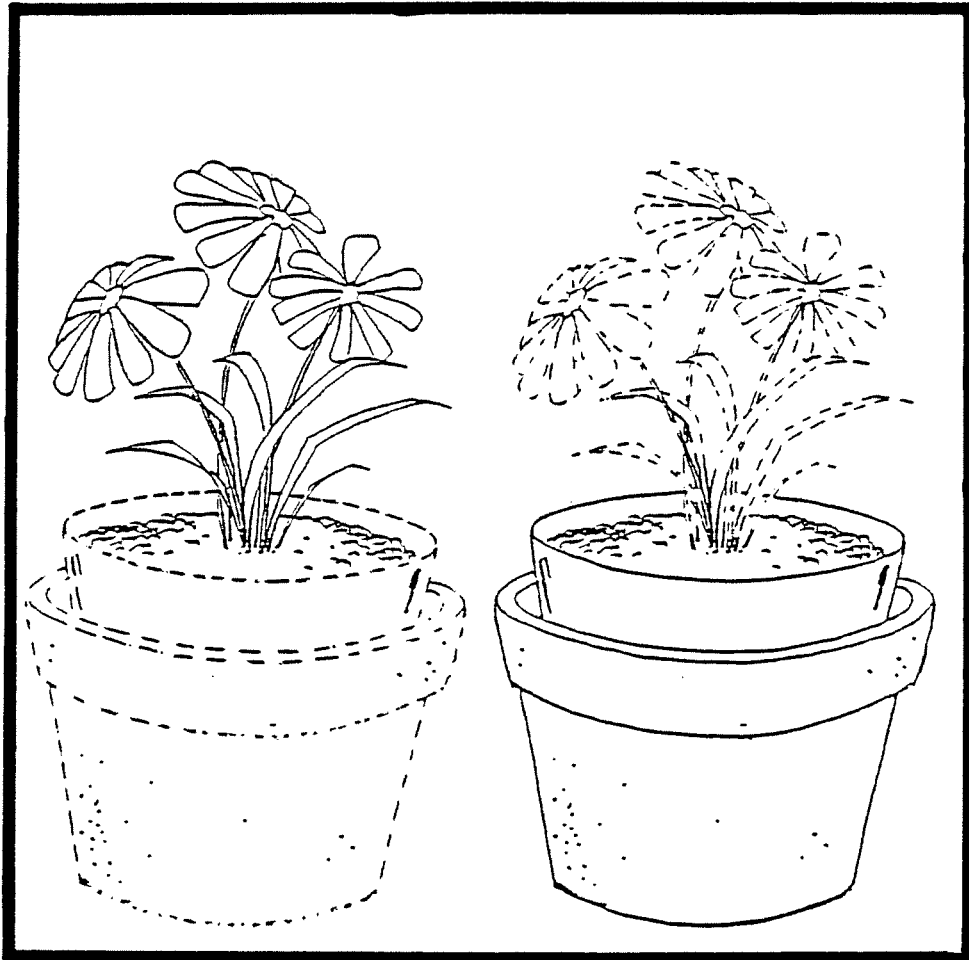

1

2



1



2



1

2

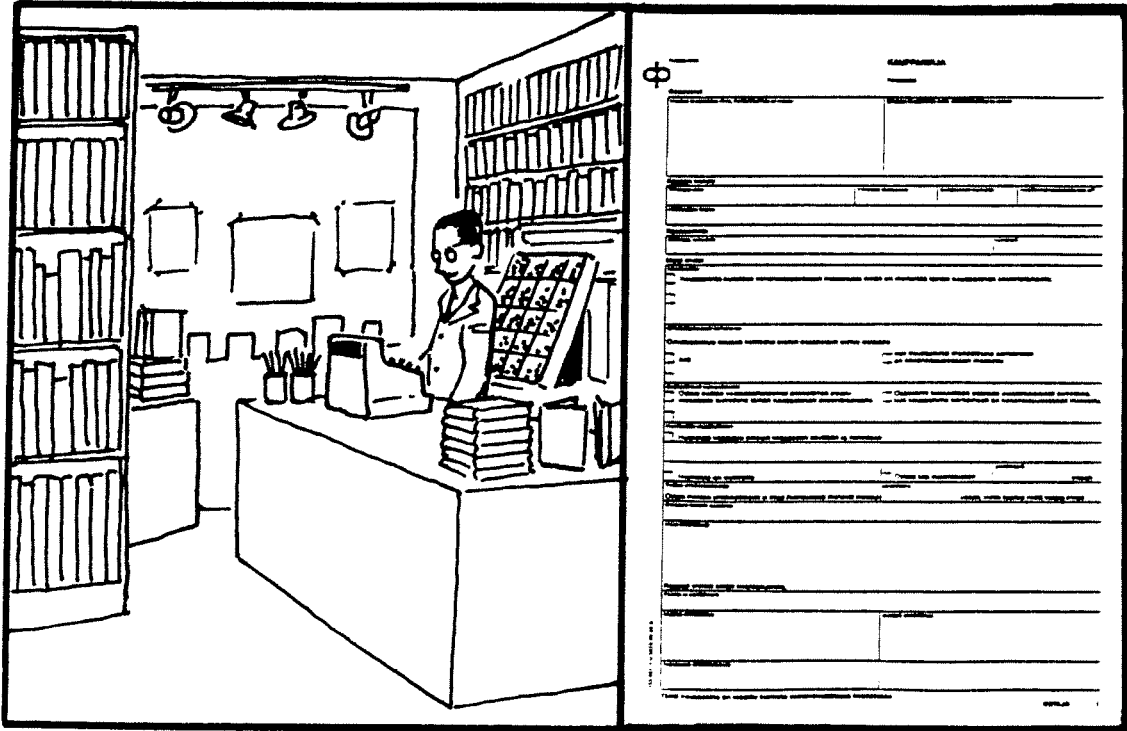

1

2



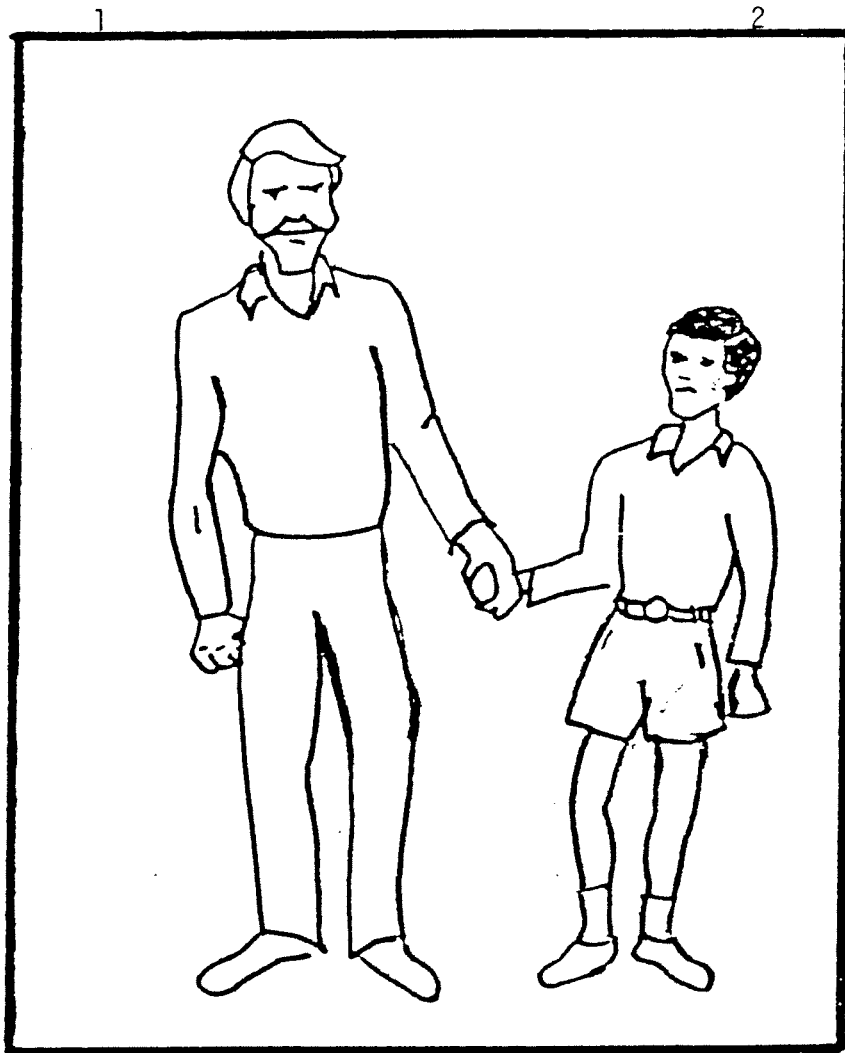

1

2

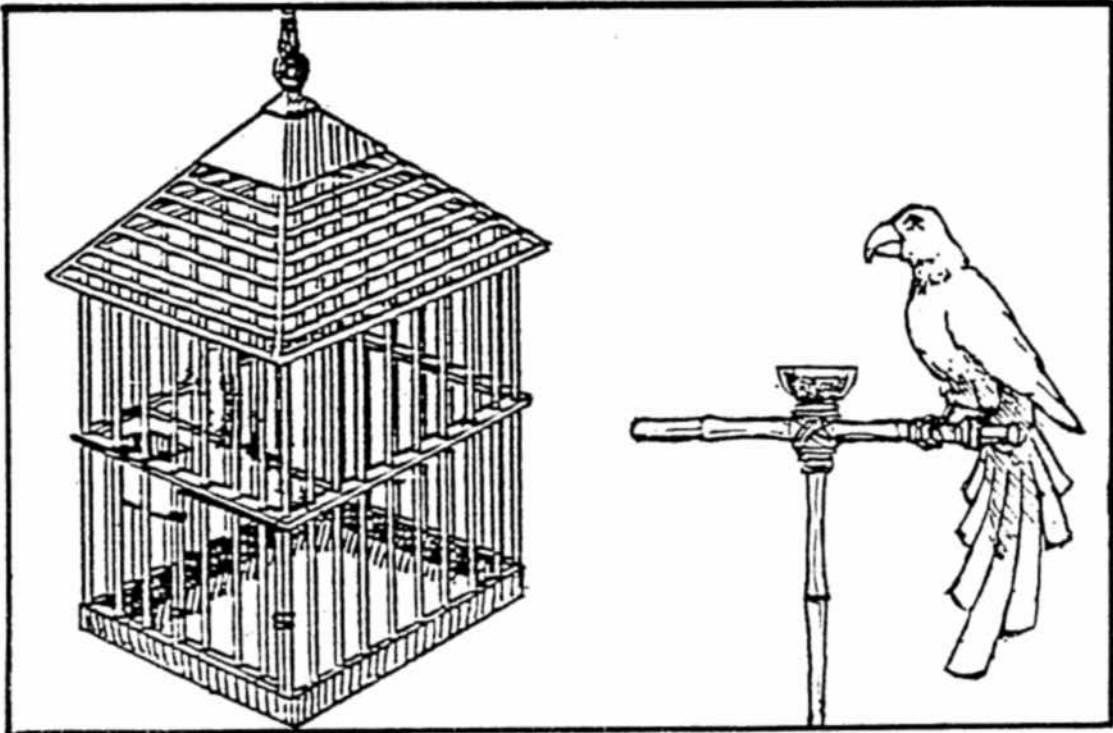

1

2

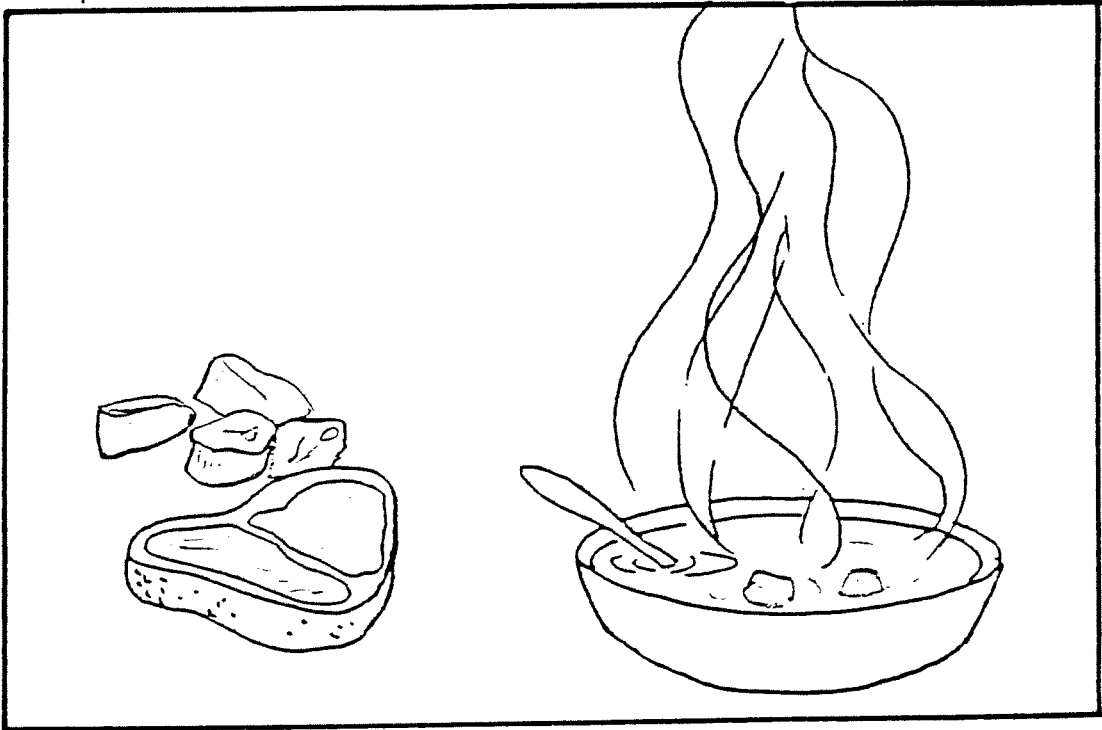

1

2

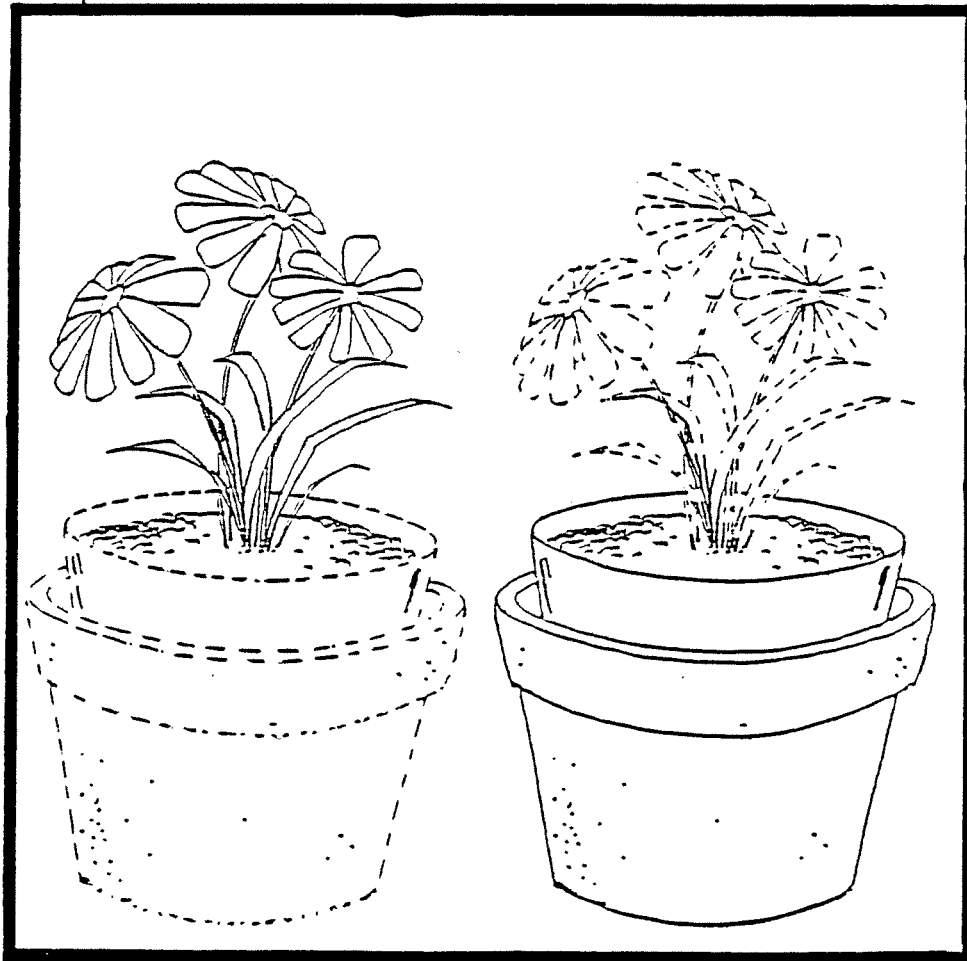

1

2



1



2



1



2



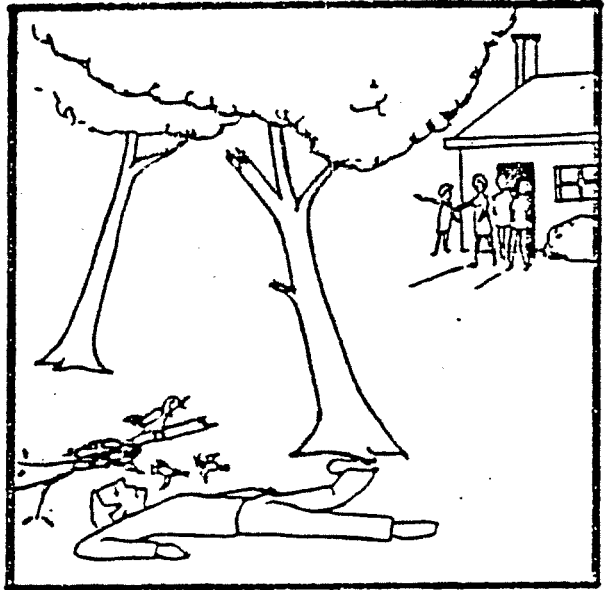
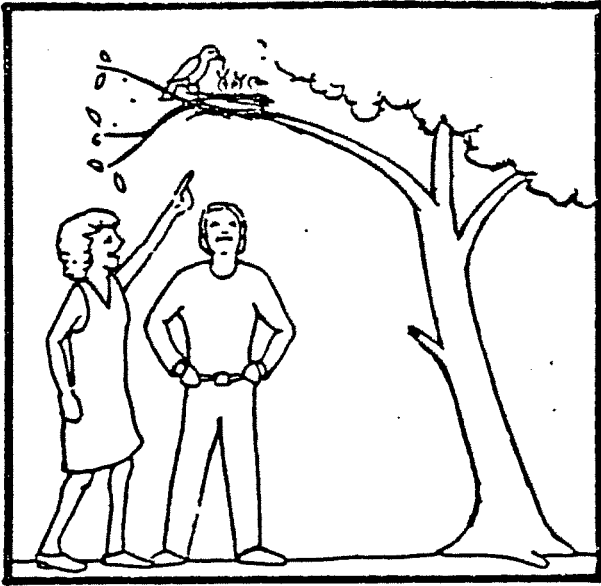

nappi

lyö

sukka

tuoli

silli

nauta

suuri

hana

baari

kuu

Isä pukee poikia.

Hän peseytyy.

Koiria purevat kissat.

Pikkuautoja kuorma-autot vetävät.

Tyttö ei kastele poikaa.

Äitiä ei herätä poika.



Purevat kissat koiria.

Hän työntää heitä.

Tyttöjä työntävät pojat.

Tyttöä ei suutele poika.

Äiti lähti tyttärensä kanssa puolukkaan.  
He saivat kokonaisen ämpärillisen puolukoita.  
Palattuaan metsästä he menivät torille ja myivät  
puolukat. Rahoilla he ostivat perunoita.

pappi

talli

saha

muuri

nakki

## LUETUN YMMÄRTÄMINEN (SANAT)

nappi

2

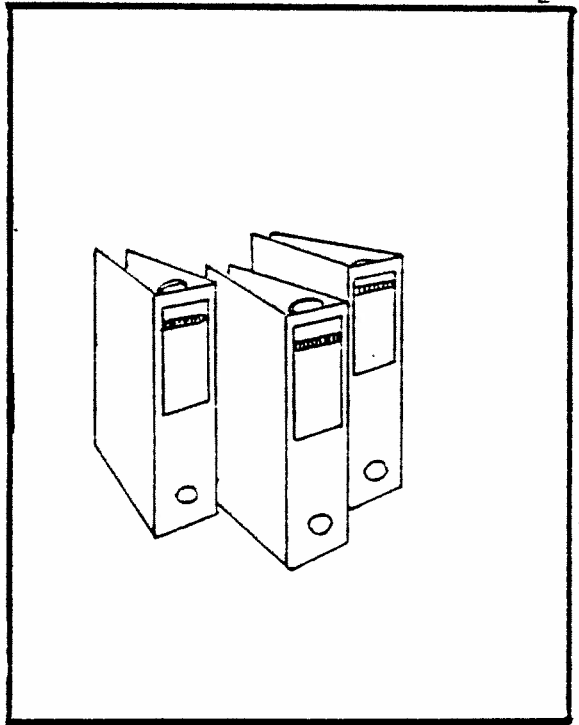

3



4

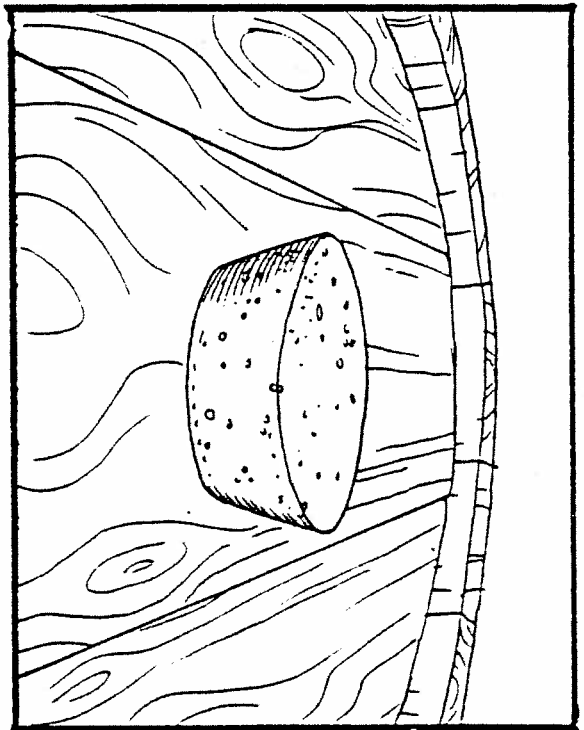

lyö



1



2

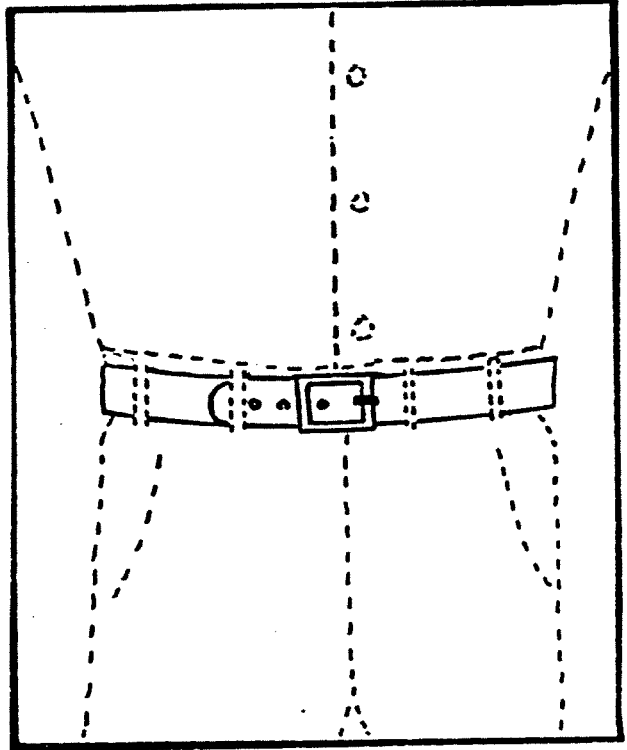

3



4

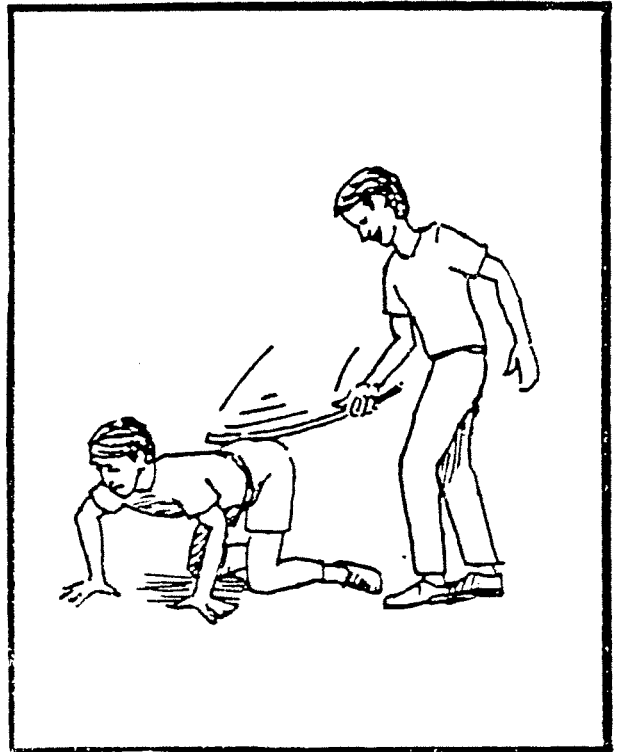

sukka

1

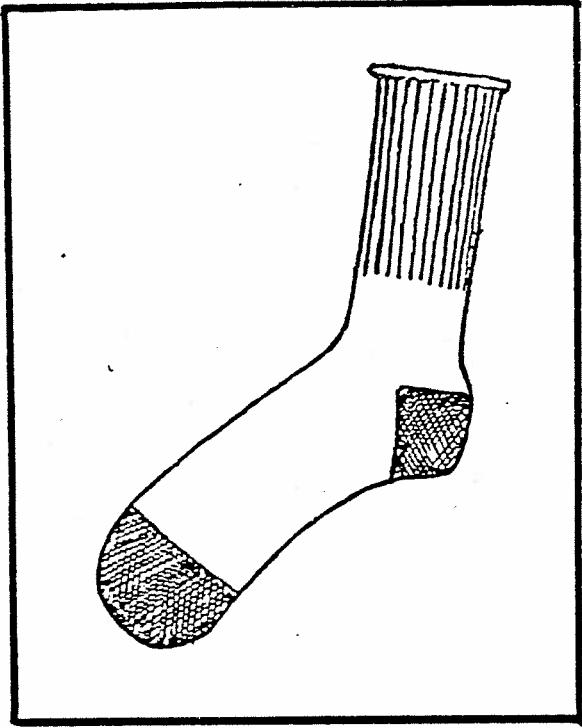

2

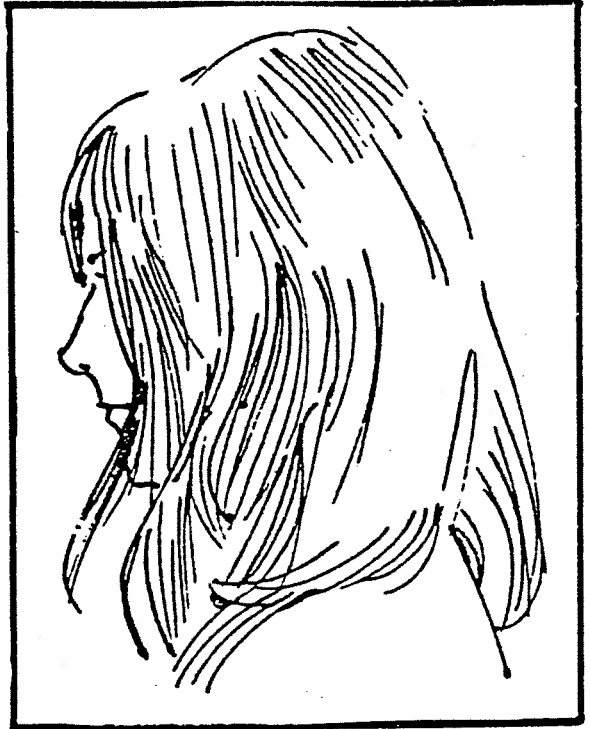

3

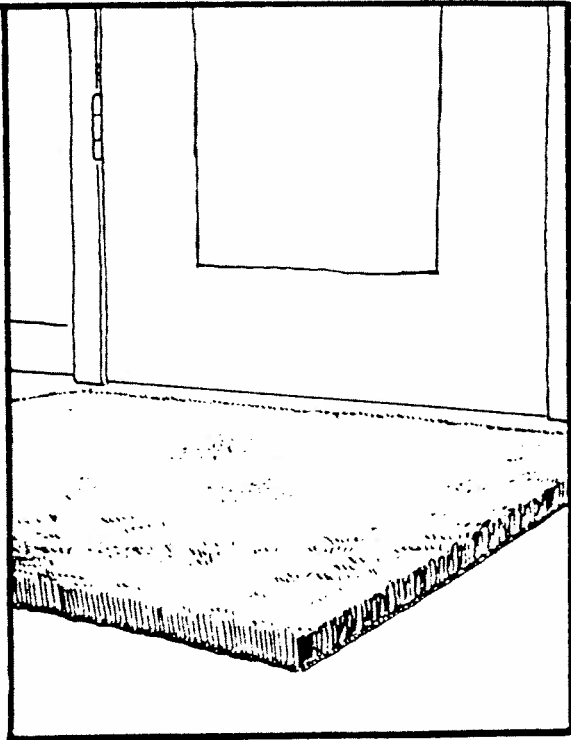

4



tuoli

1

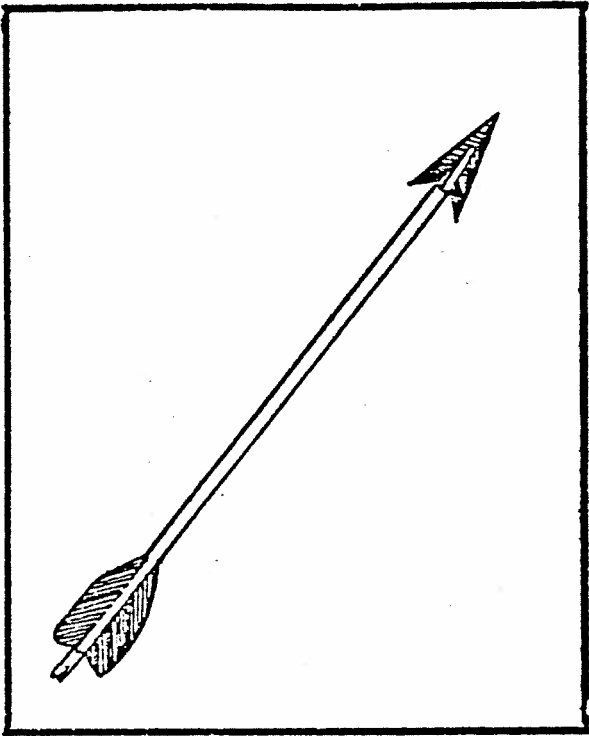

2

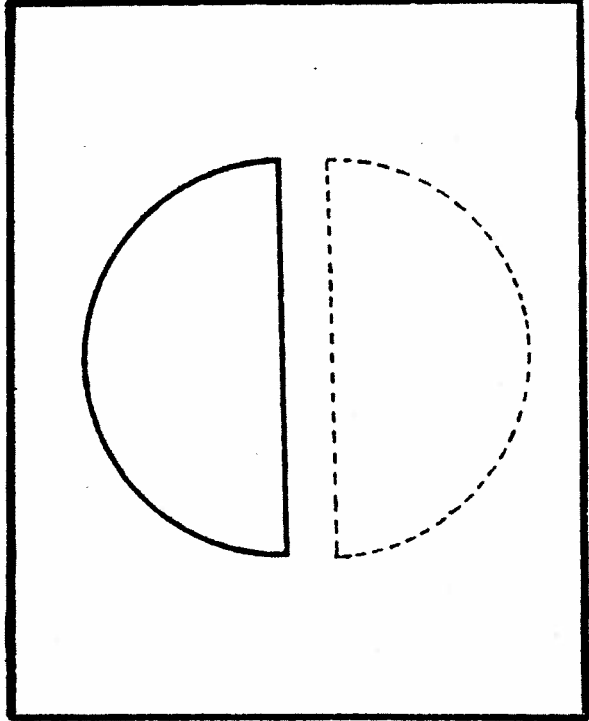

3

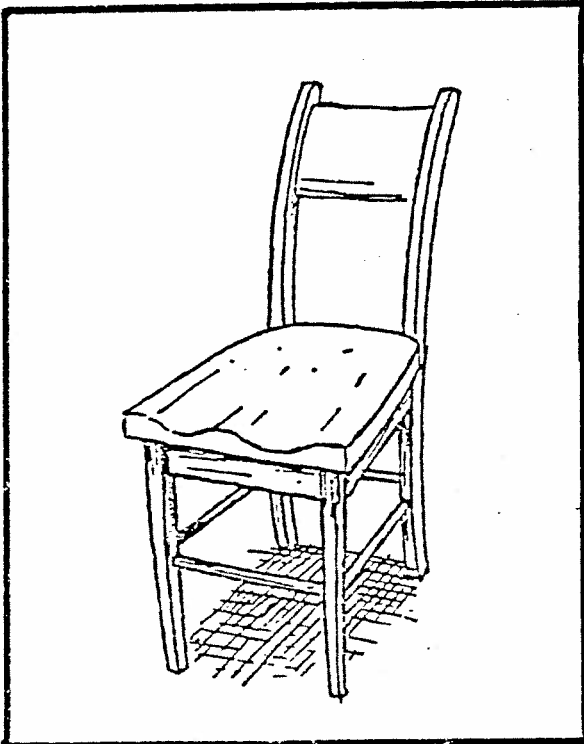

4

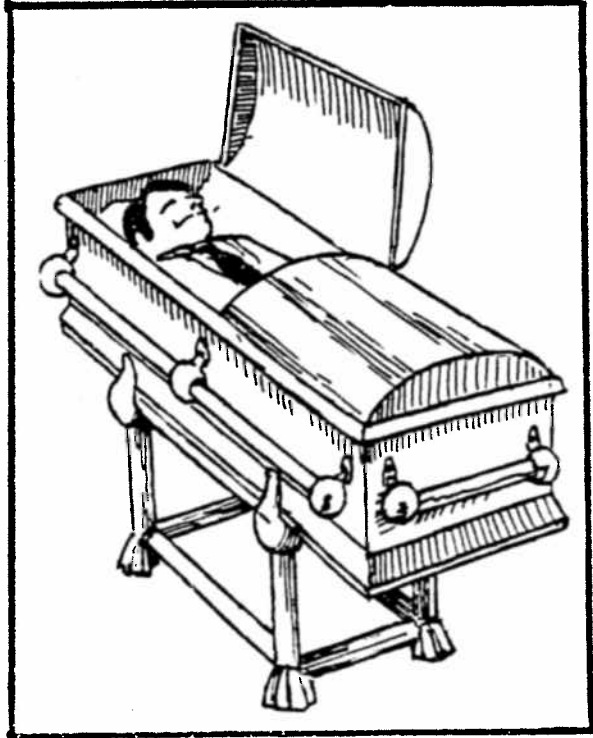

**sili**

1

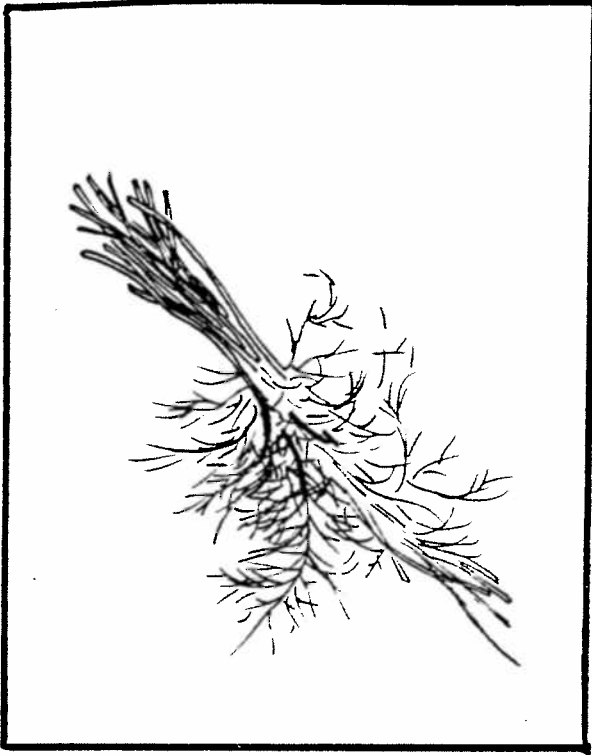

2

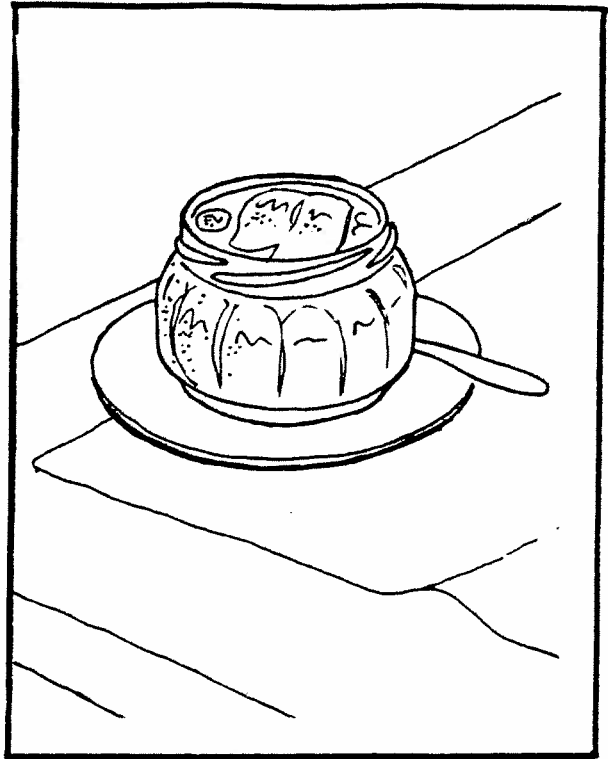

3

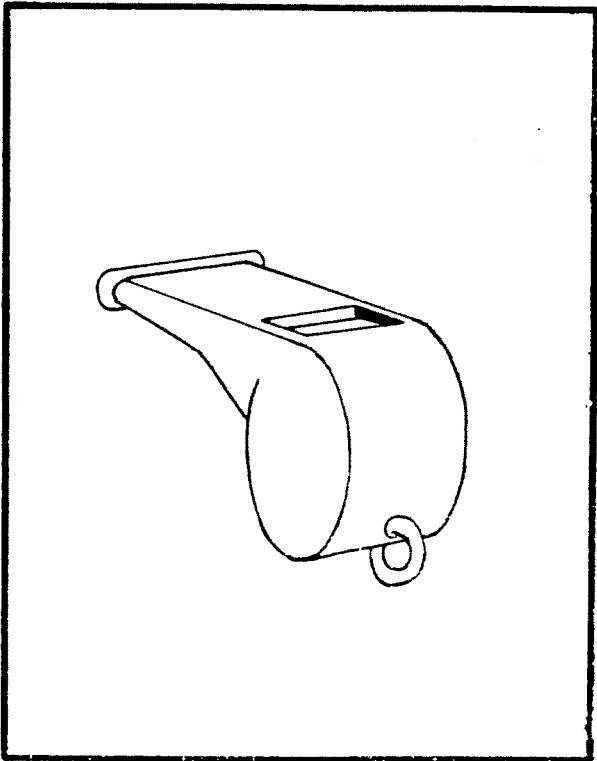

4

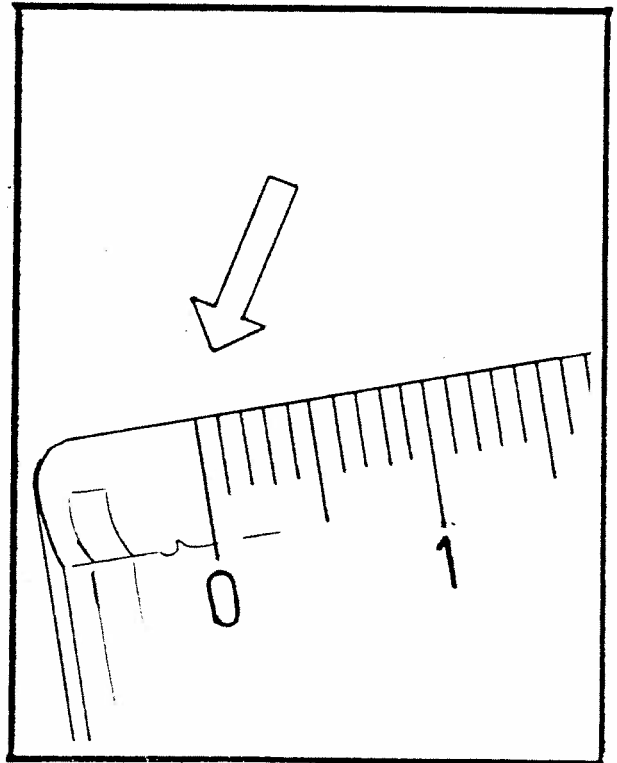

nauta



1



2

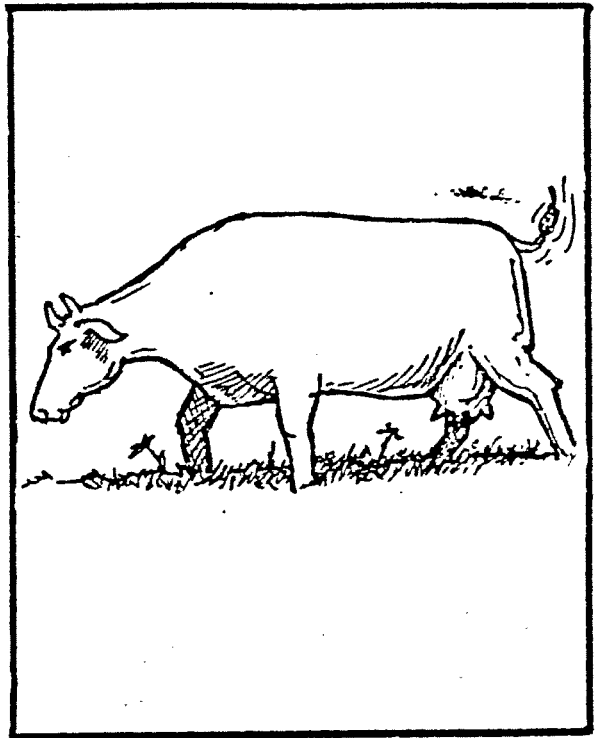

3

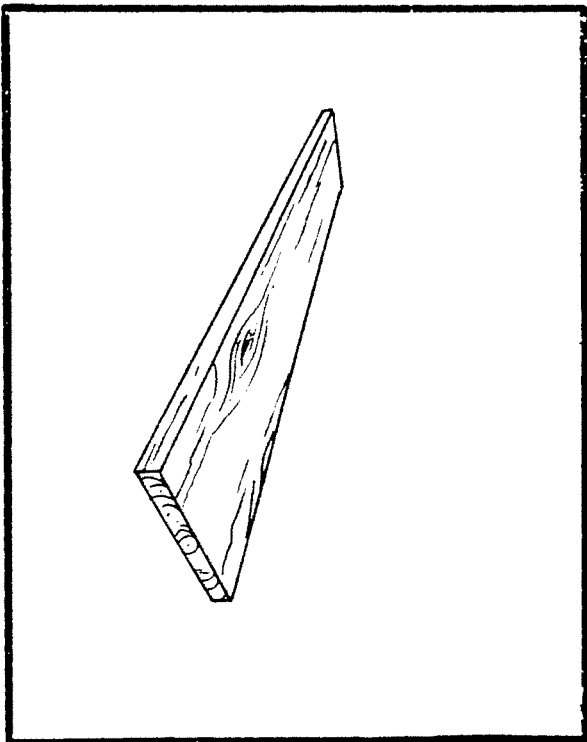

4

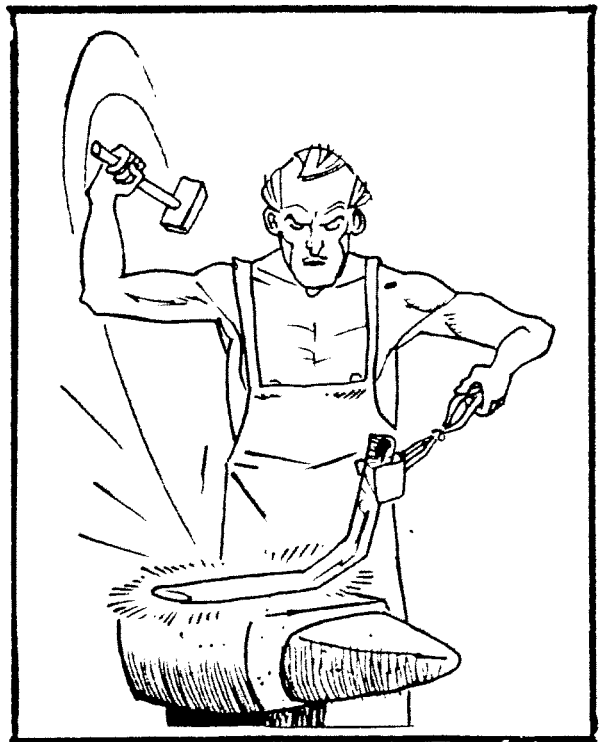

suuri

1

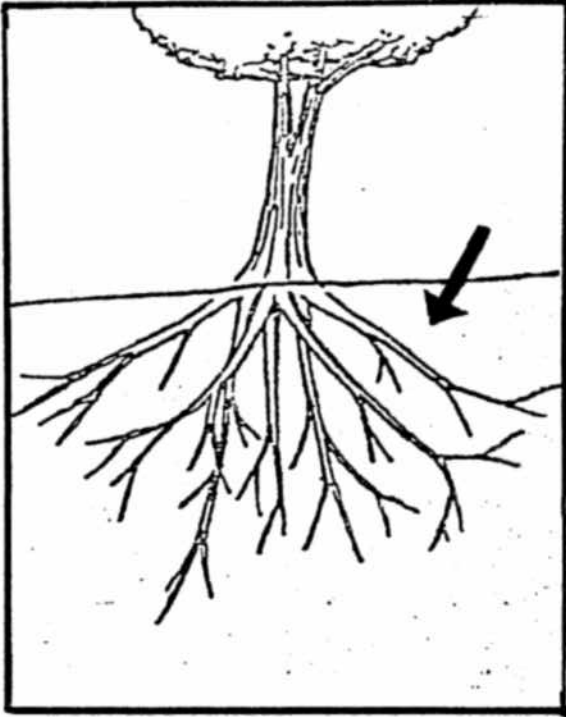

2

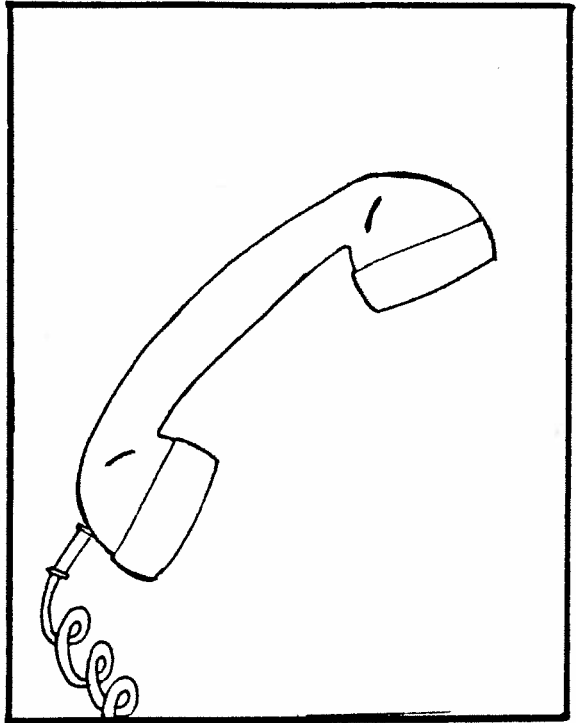

3

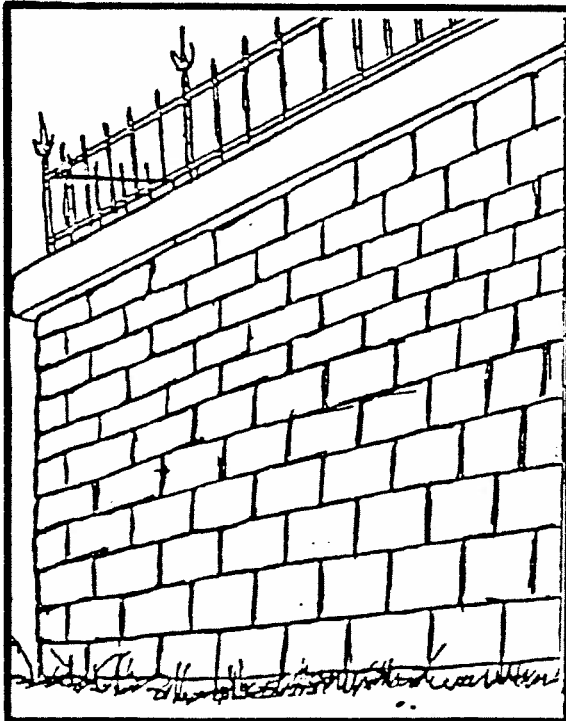

4

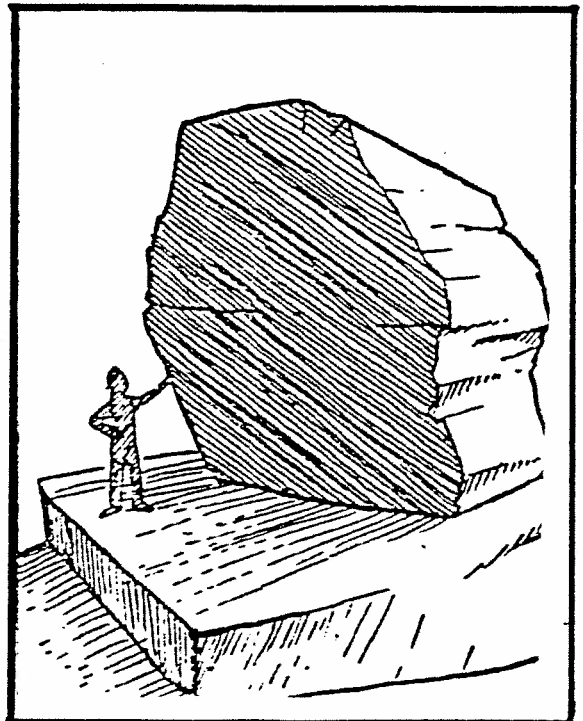

hana

1

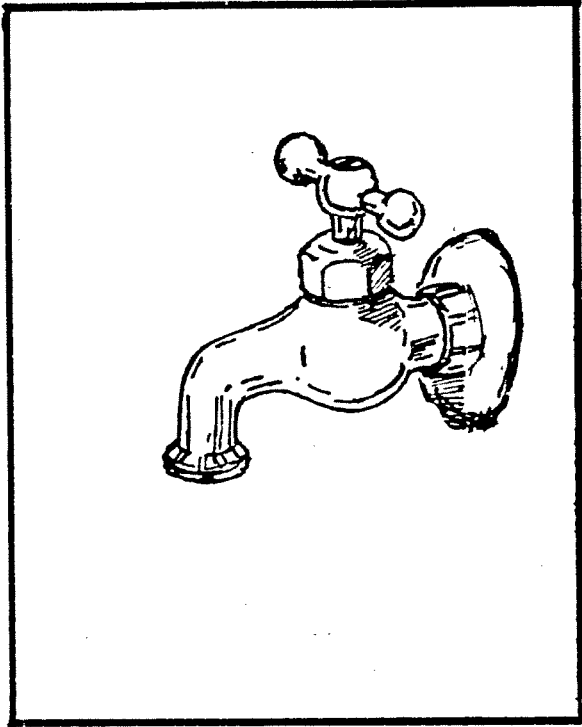

2

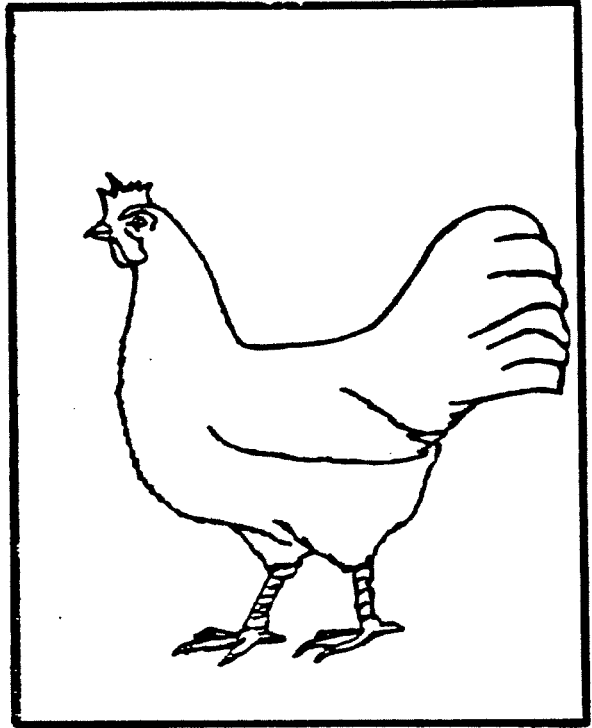

3

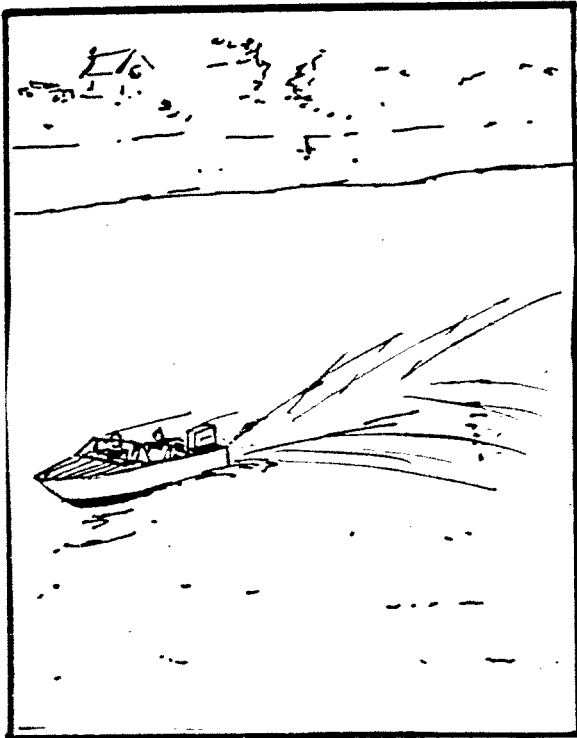

4

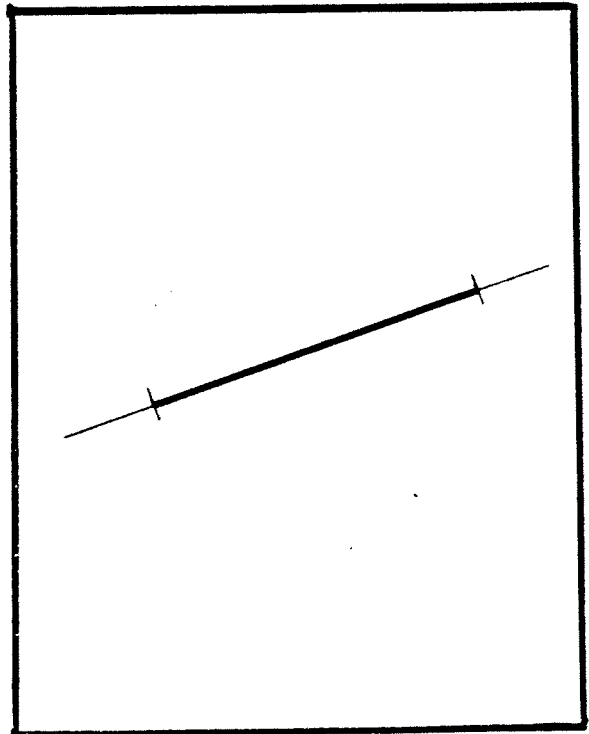

baari

1



2

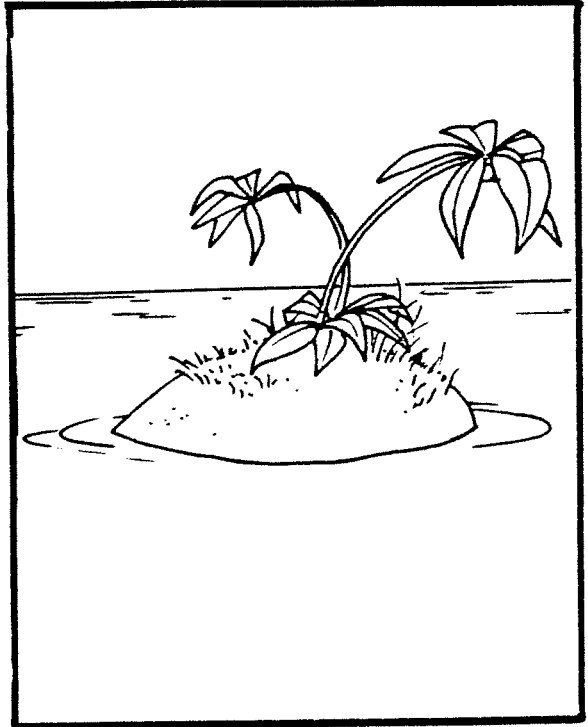

3

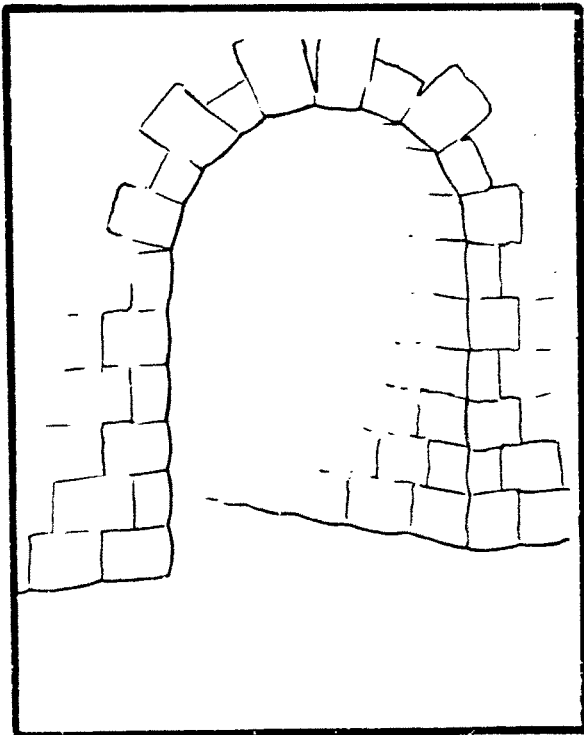

4

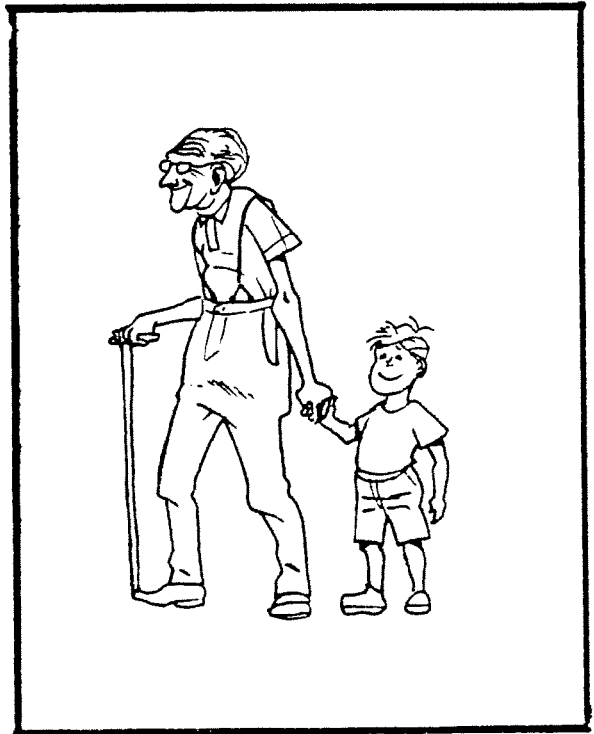

kuu



1

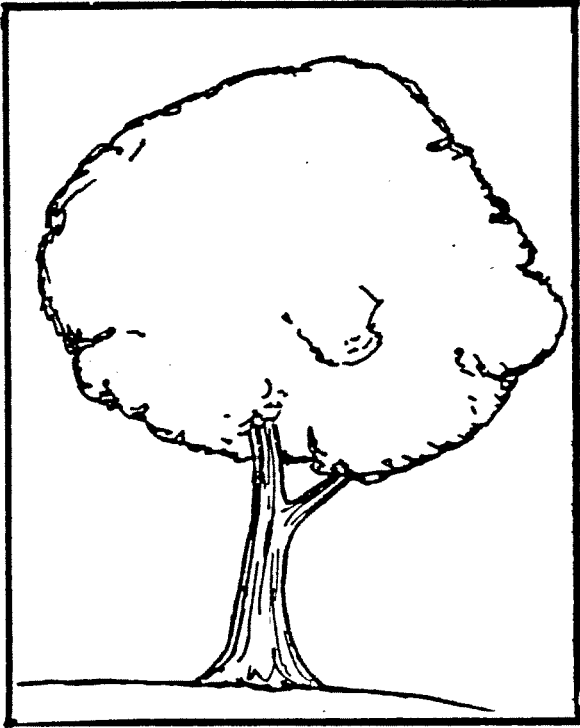

2

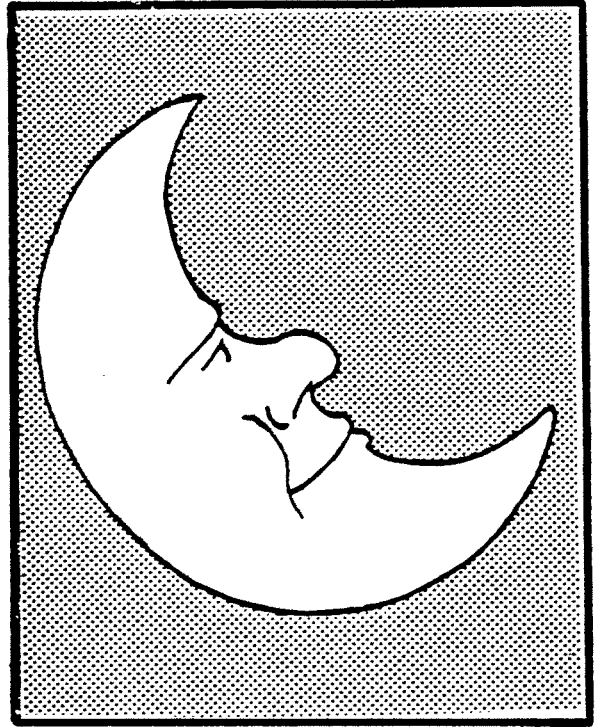

3

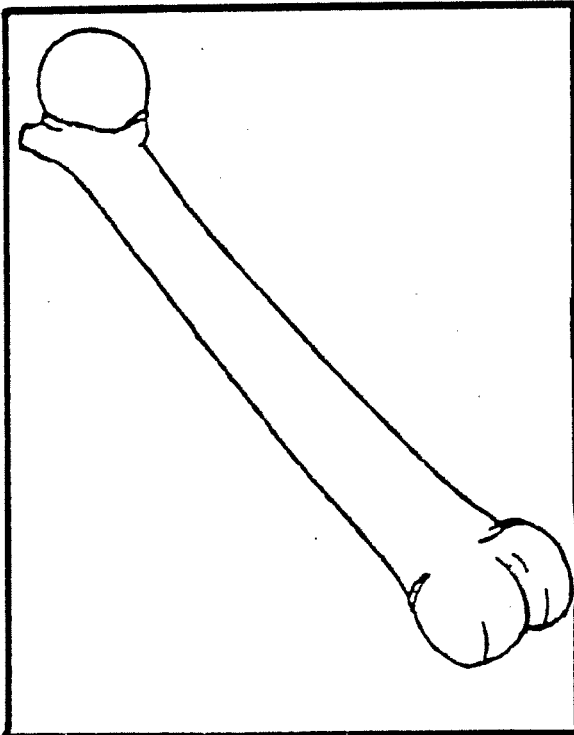

4

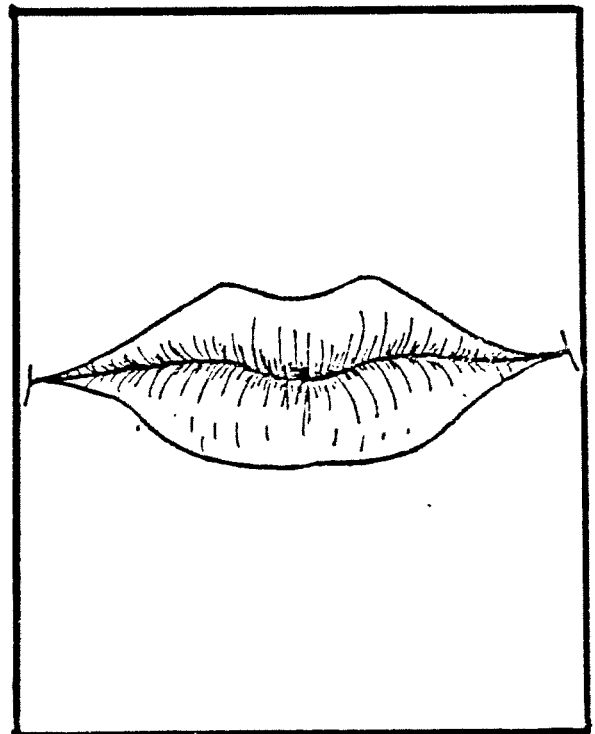



## LUETUN YMMÄRTÄMINEN (LAUSEET)

Isä pukee poikia.

1



2



3

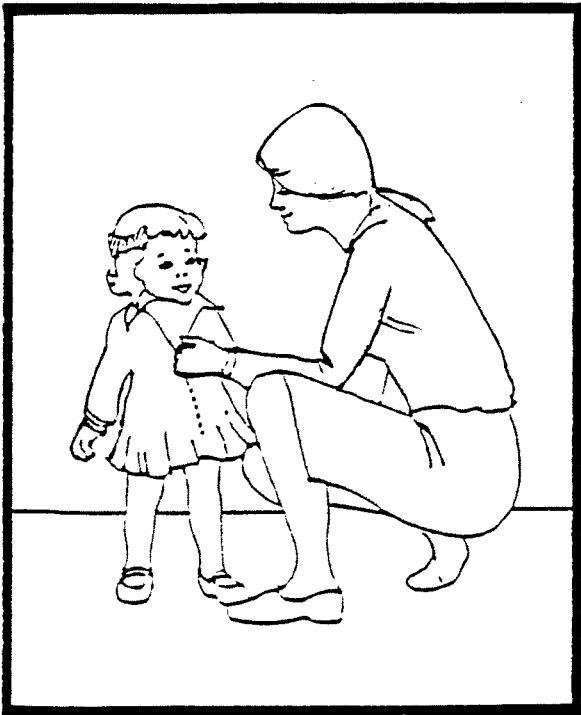

4



Hän peseytyy.

1



2

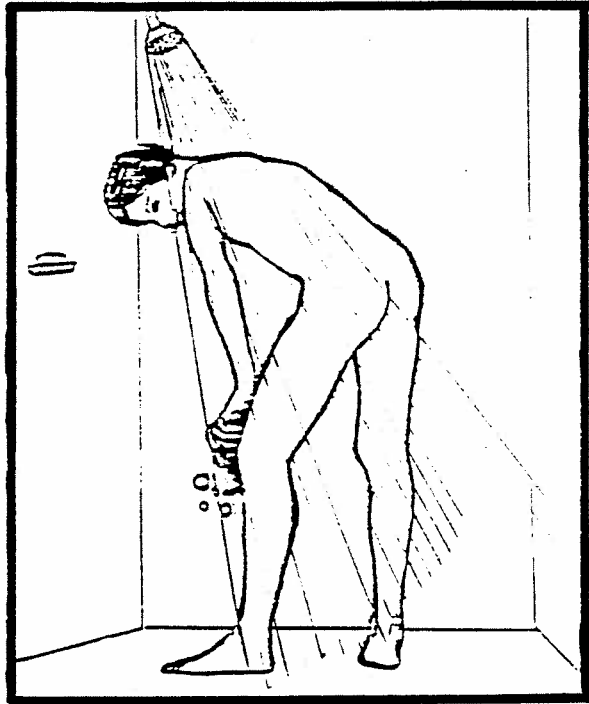

3

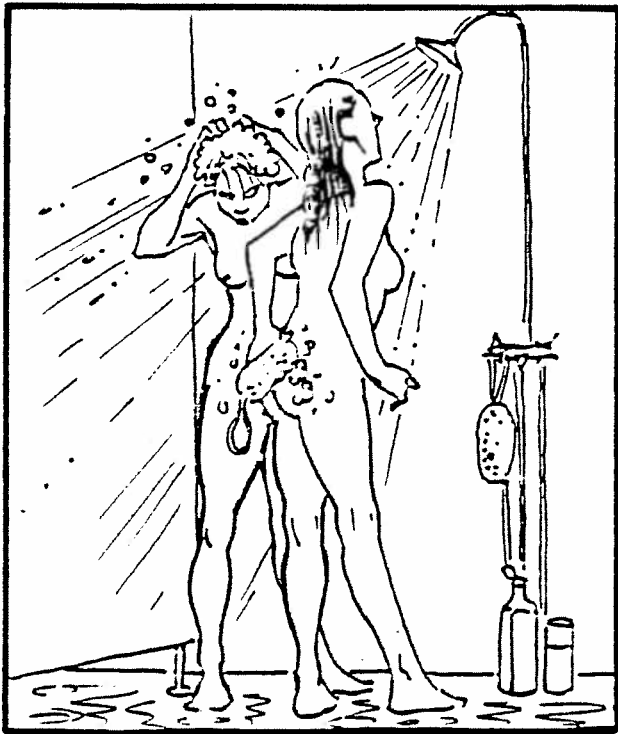

4



**Koiria purevat kissat.**



1

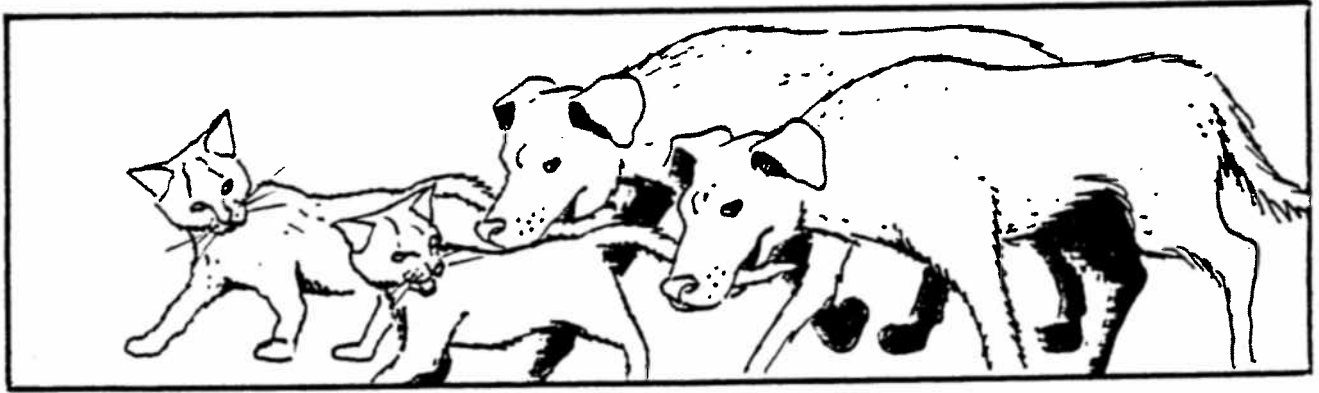

2

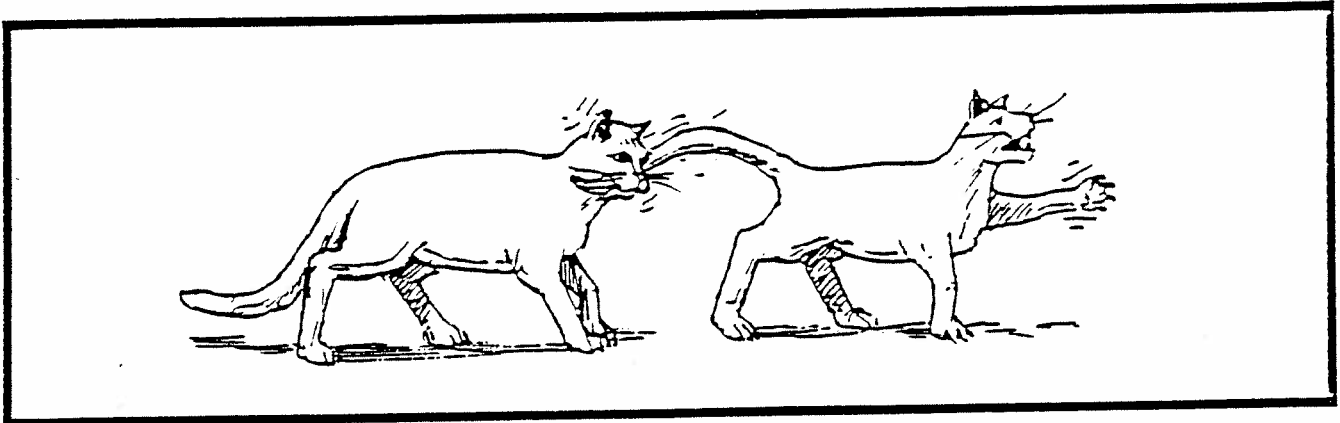

3



4

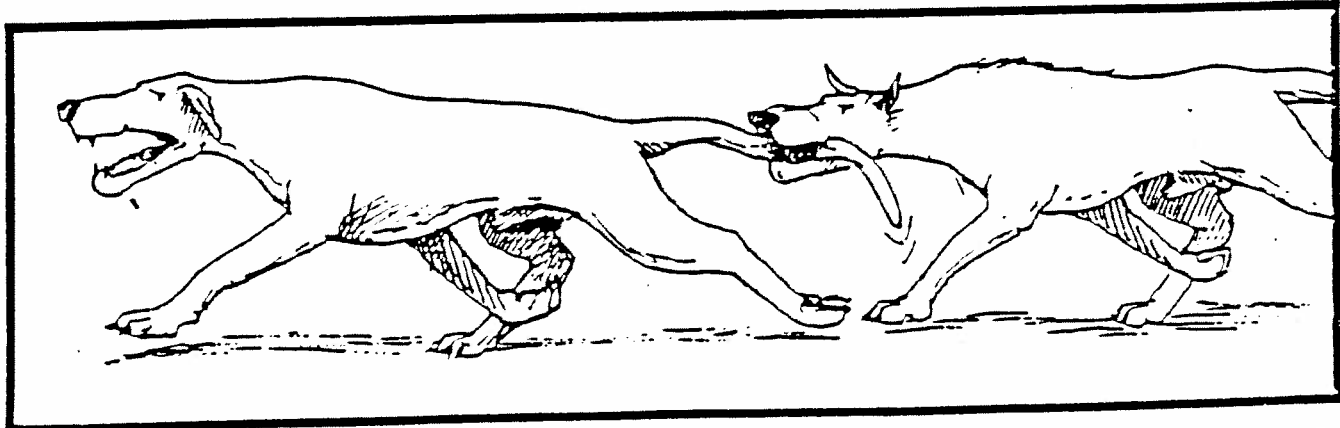

Pikkuautoja kuorma-autot vetävät.

1

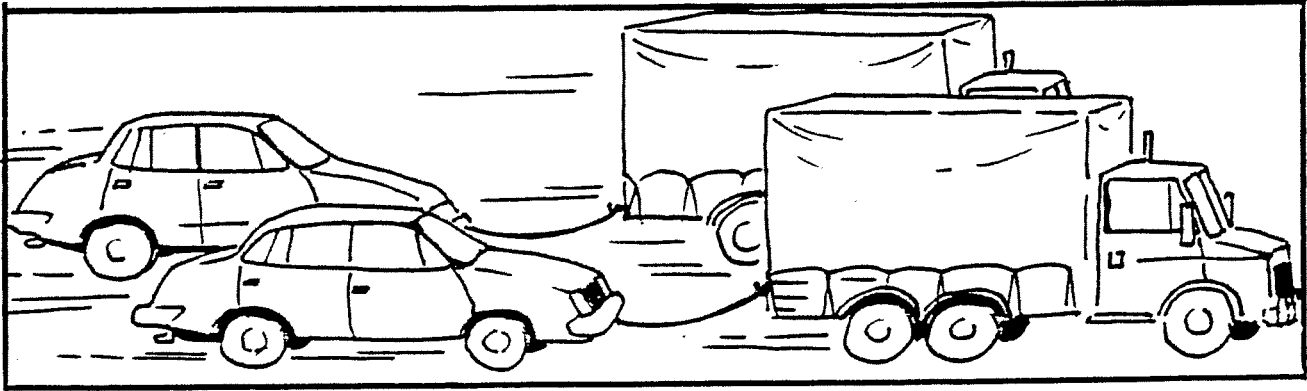

2

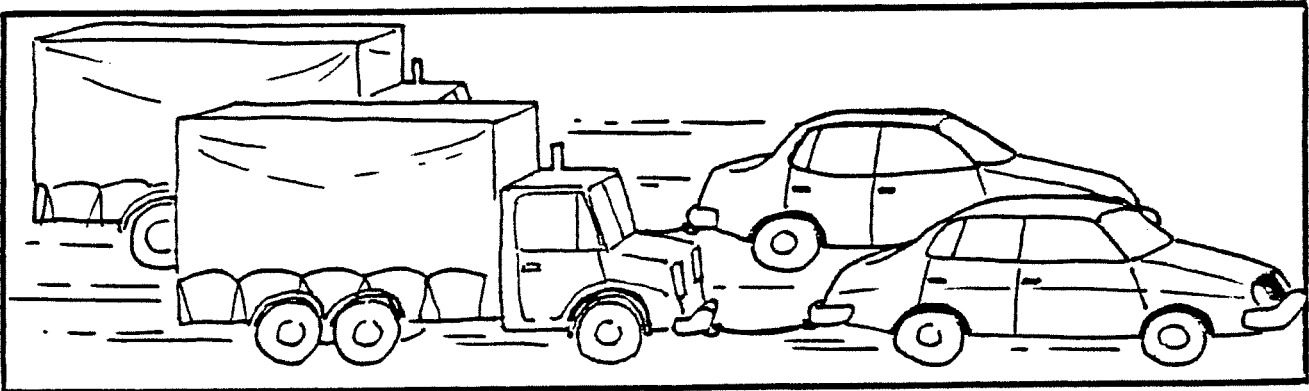

3

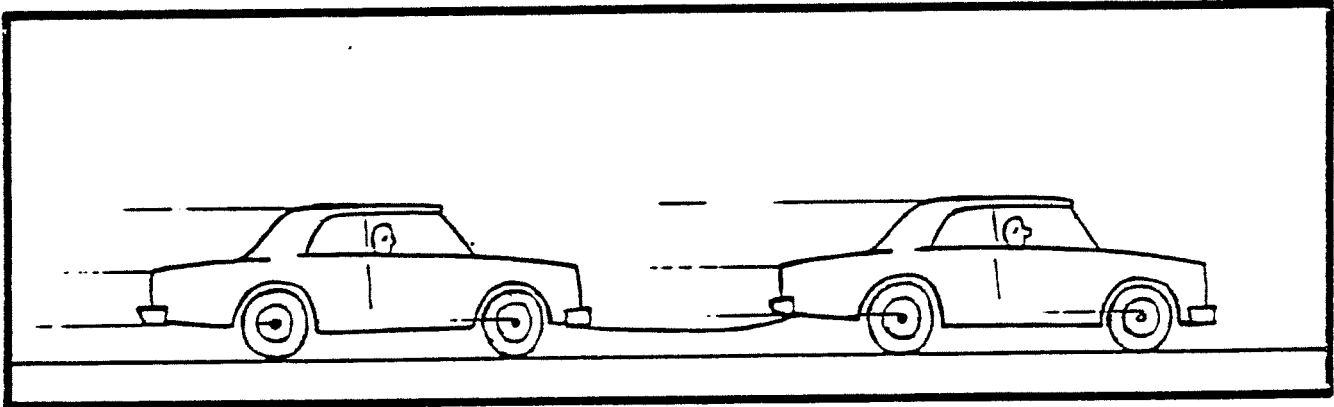

4

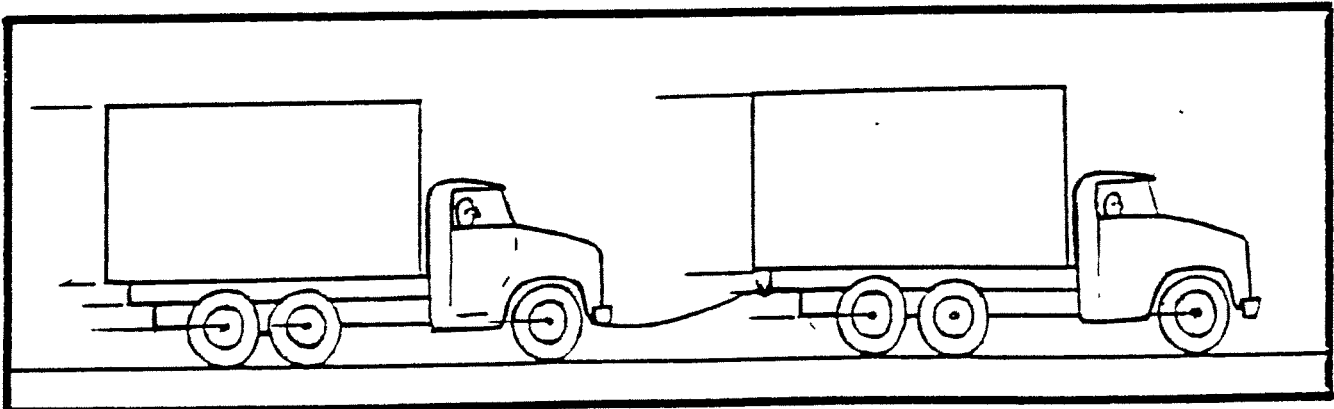

Tyttö ei kastele poikaa.

1

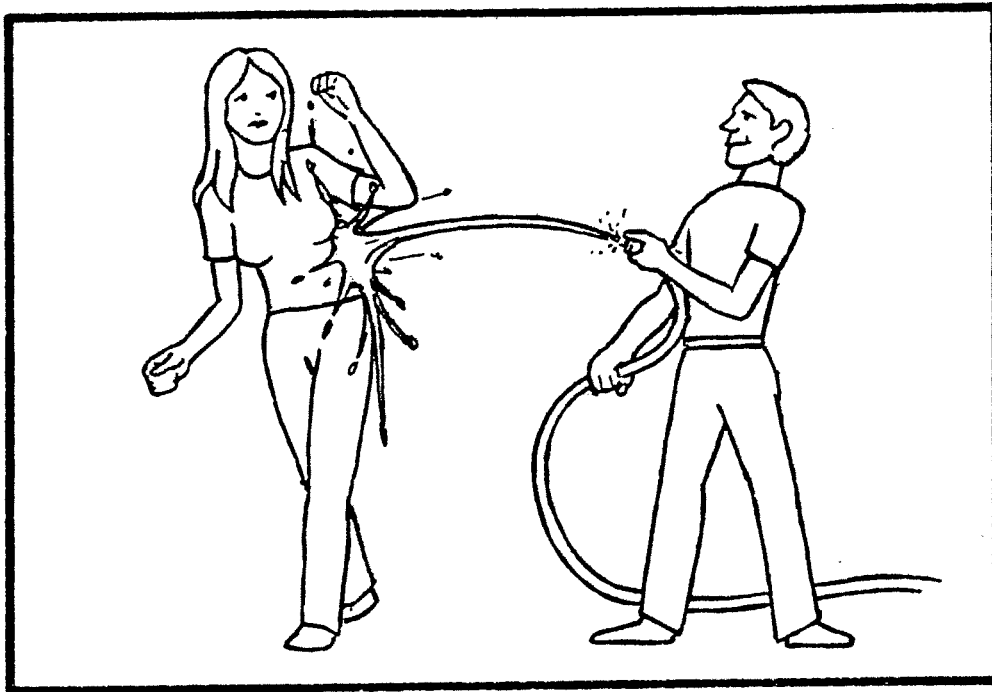

2

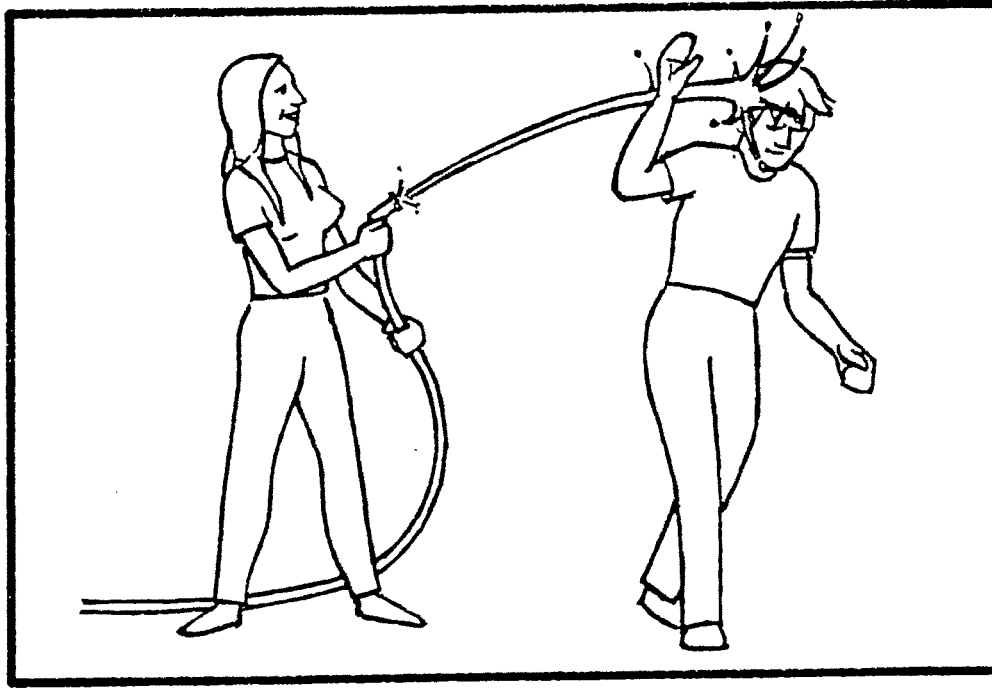

Äitiä ei herätä poika.

1

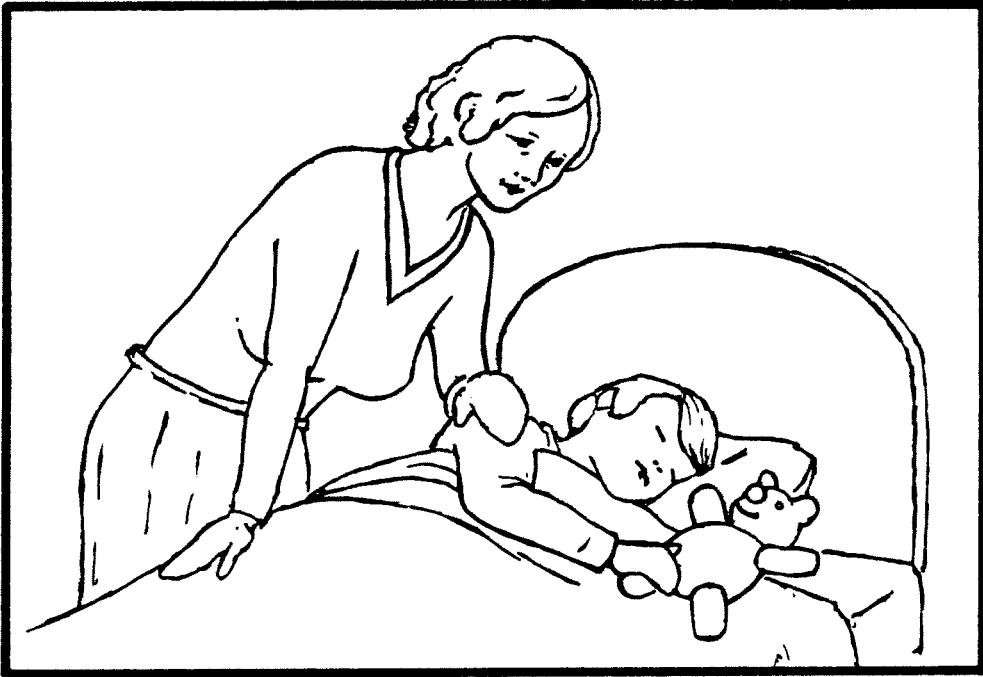

2

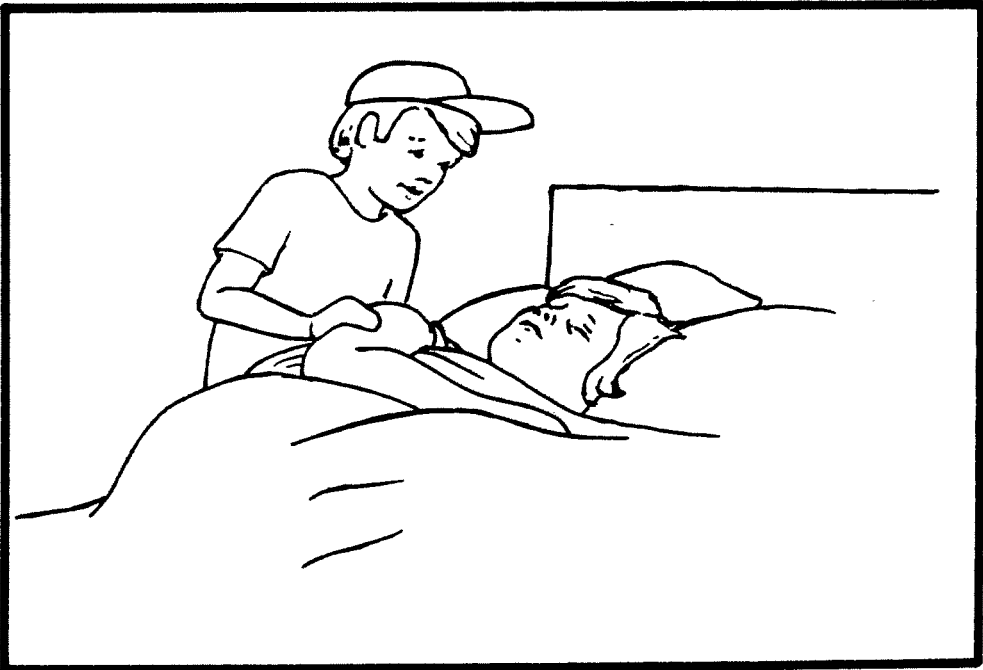

Purevat kissat koiria.



1

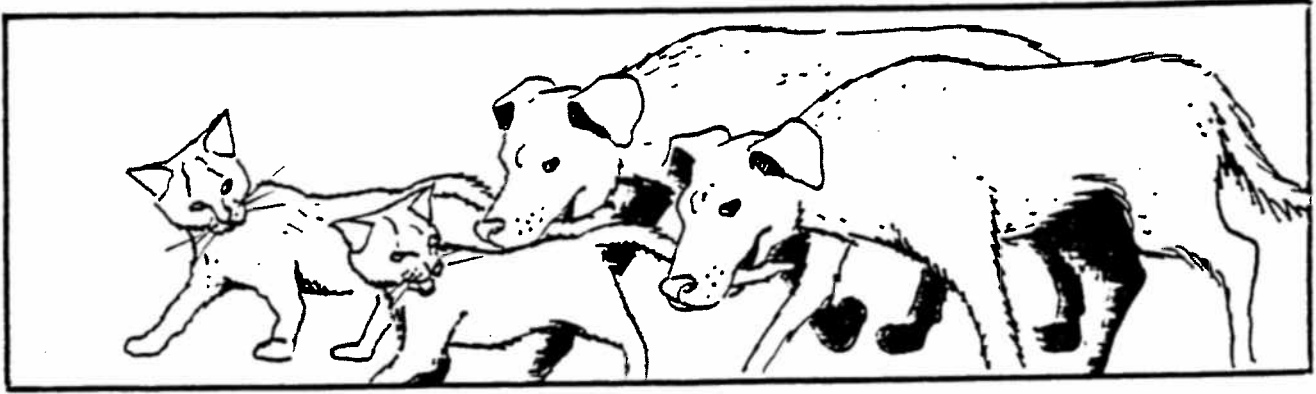

2

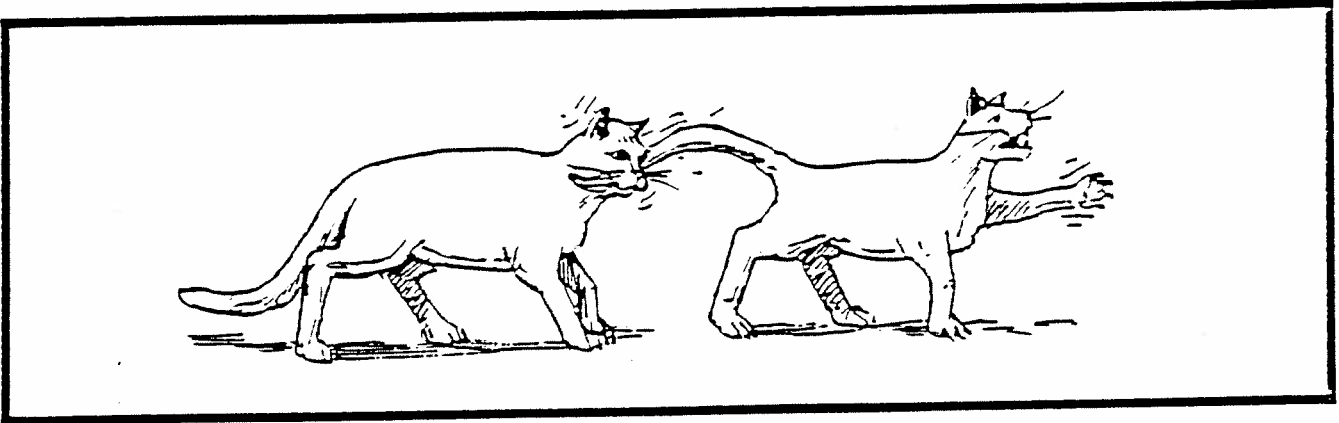

3



4

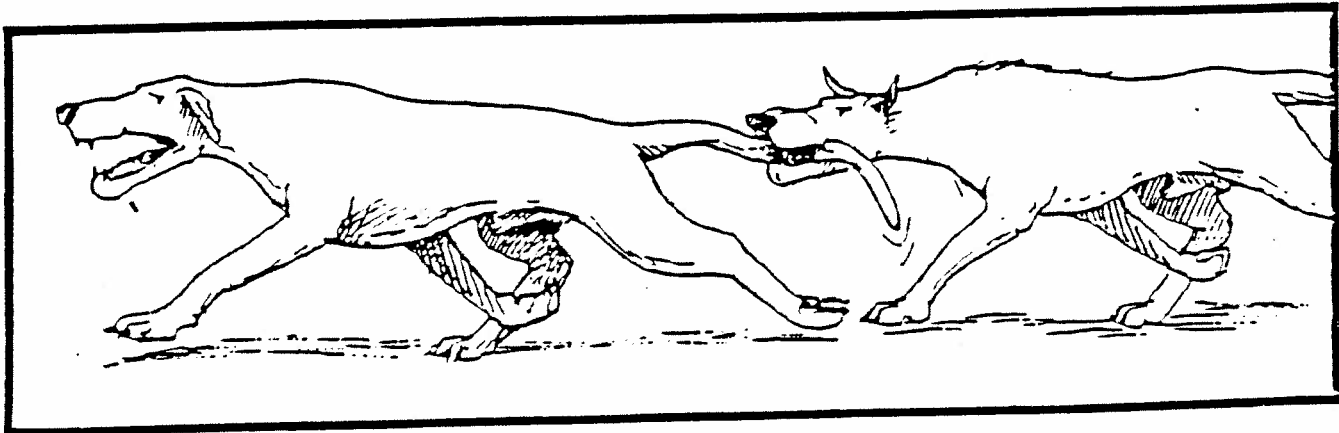

Hän työntää heitä.

1

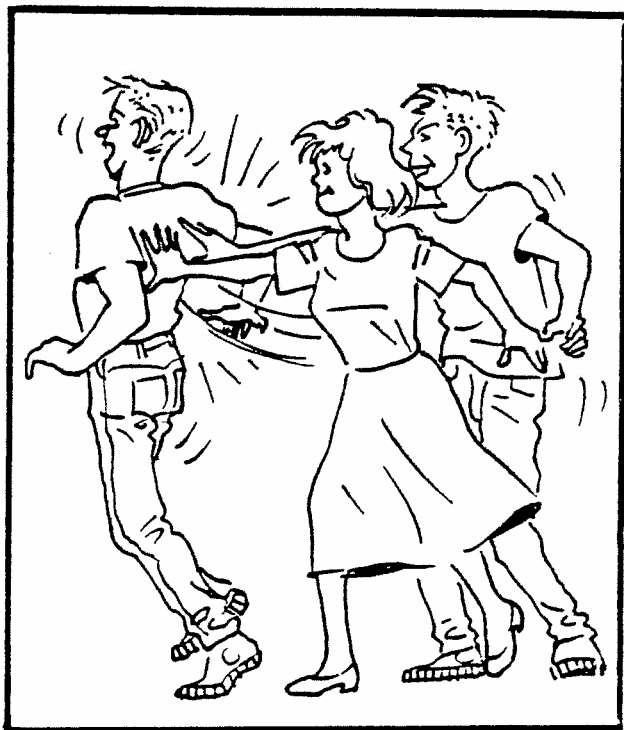

2



3

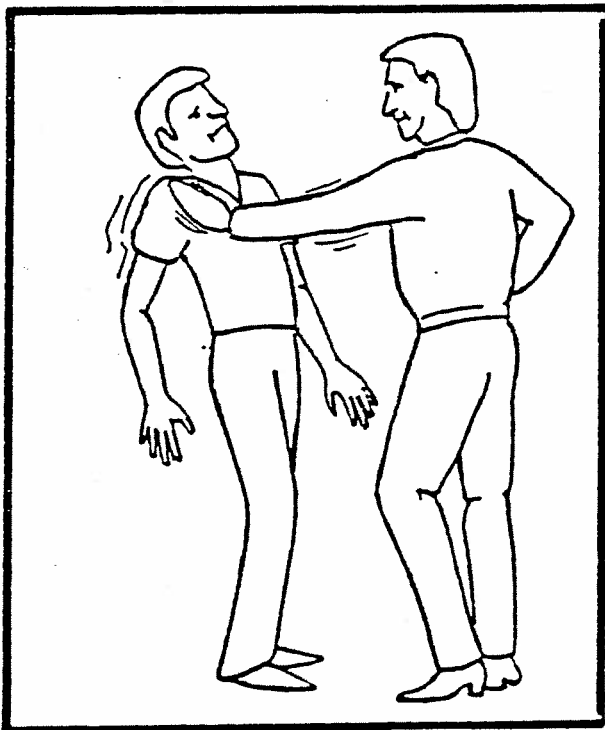

4

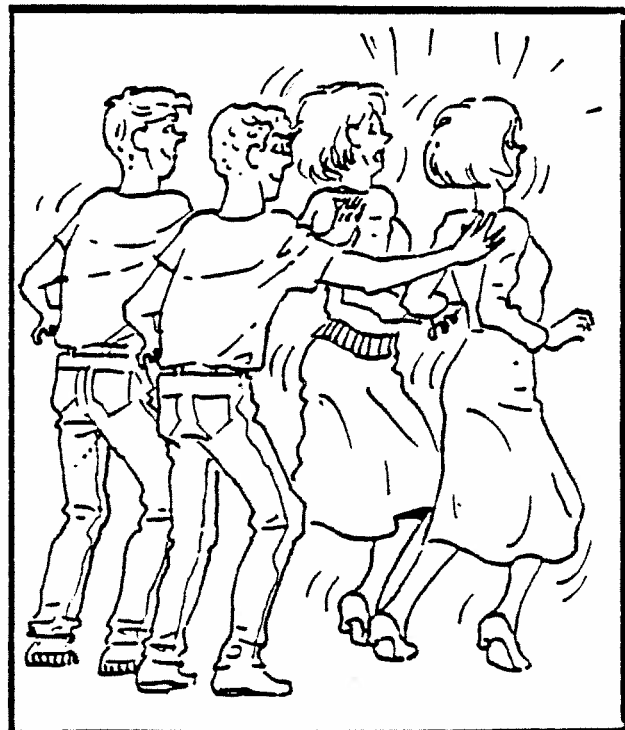

Tyttöjä työntävät pojat.

1

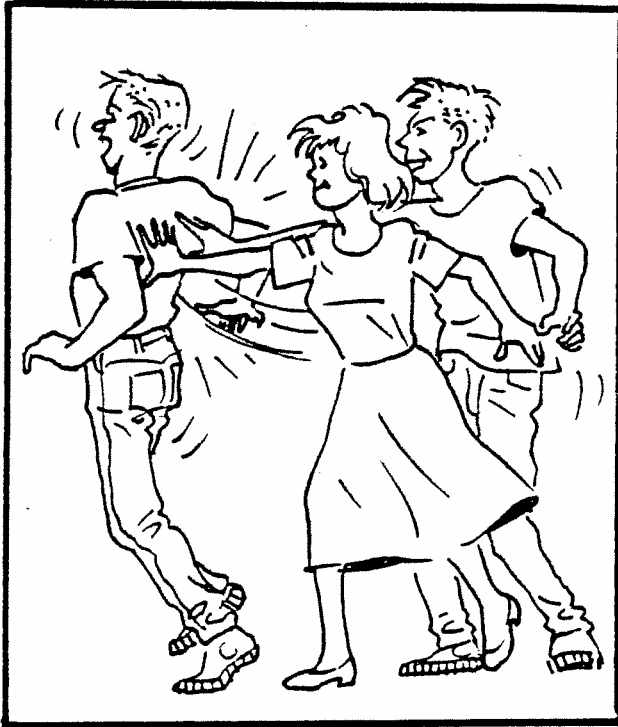

2



3



4



Tyttöä ei suutele poika.

1



2

