

Michel Paradis
McGill University

BILINGUAL APHASIA TEST
(BULGARIAN VERSION)

STIMULUS BOOK

ВЪЛГАРСКА ВЕРСИЯ

The development of the Bilingual Aphasia Test materials was supported by Grant MEQ 01-07-k (1976-1983) from the Quebec Ministry of Intergovernmental Affairs, Grant EQ 1660 (1980-1985) from the Quebec Ministry of Education FCAC Fund, and Grants 410-83-1028 (1984, 1985) and 410-88-0821 (1989-1991) from the Social Sciences and Humanities Research Council of Canada.

РИСУНКИ

СЛУХОВО-СЛОВЕСНО РАЗГРАНИЧАВАНЕ

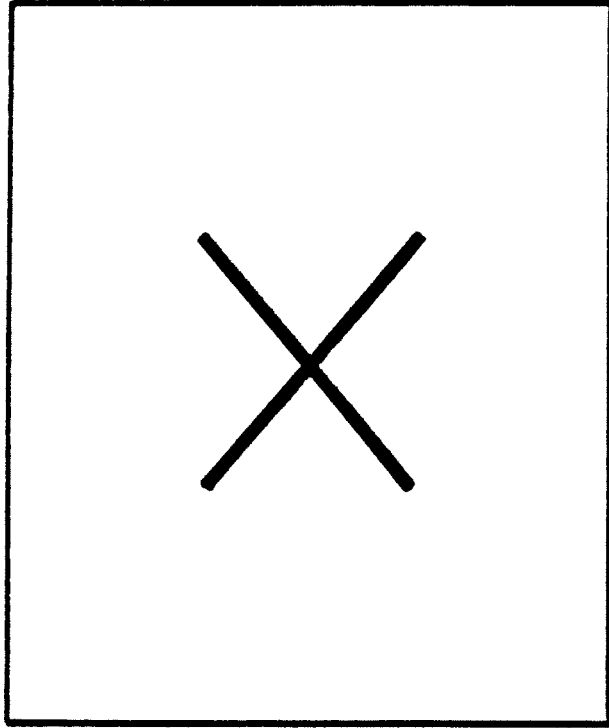

1

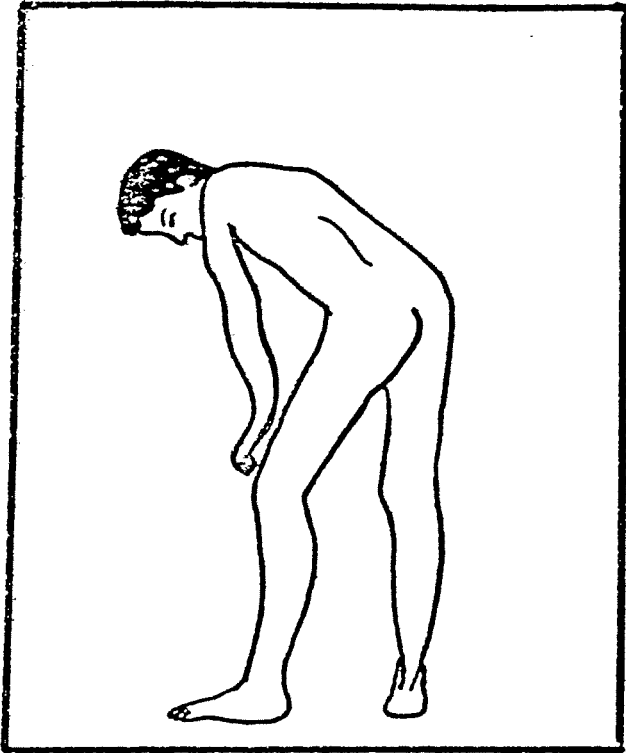

2

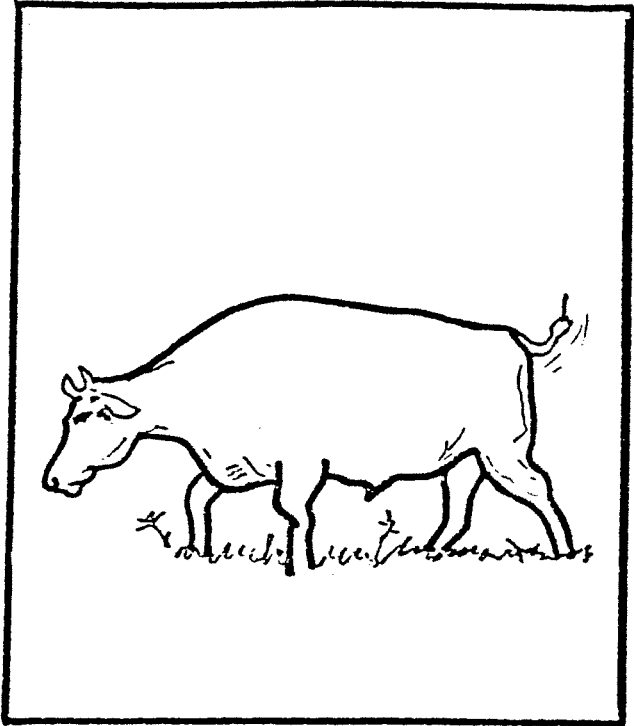

3

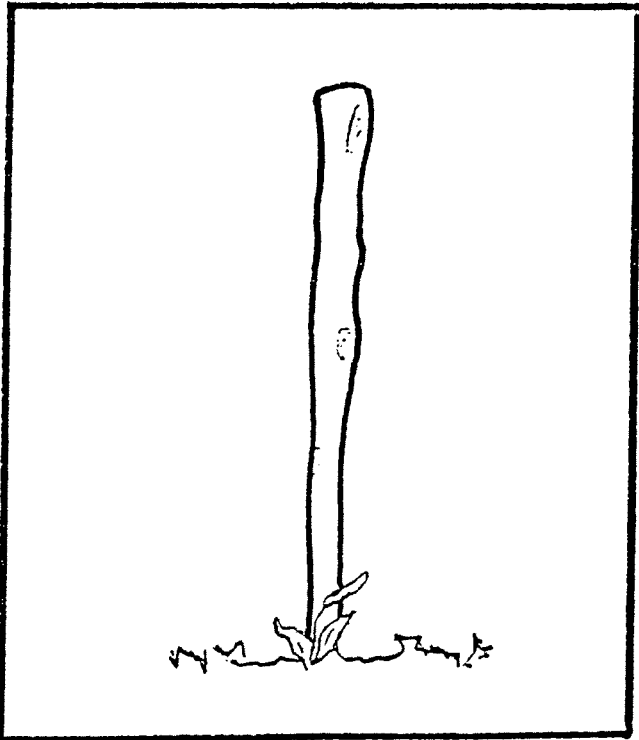

4

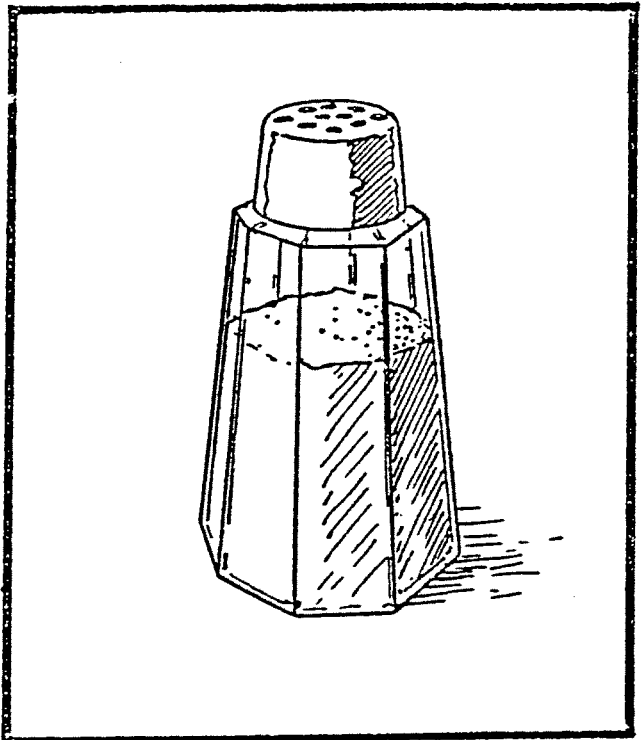

1

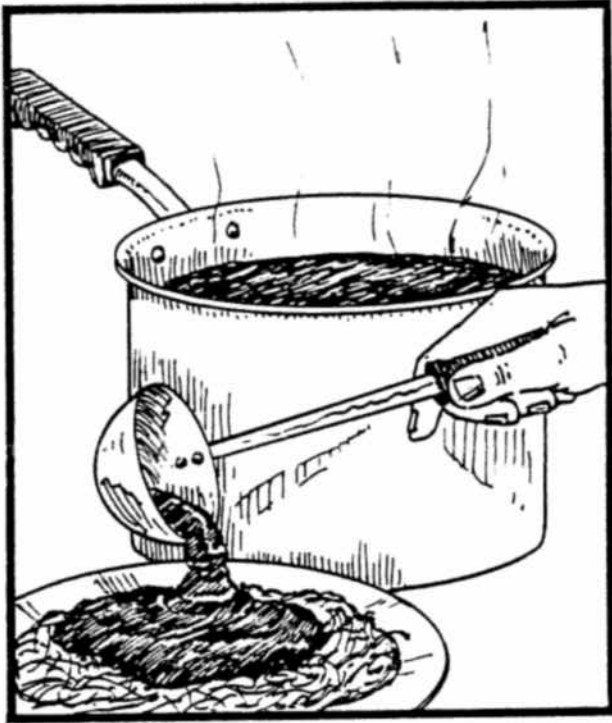

2

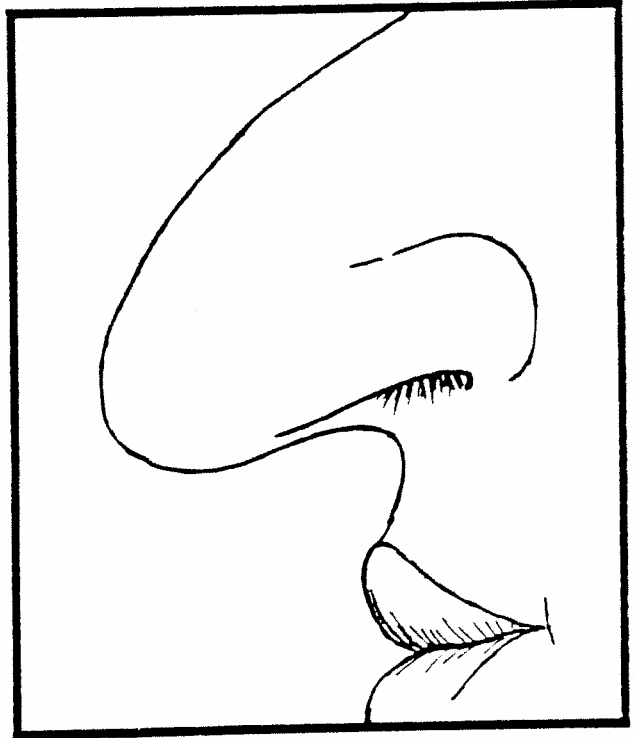

3

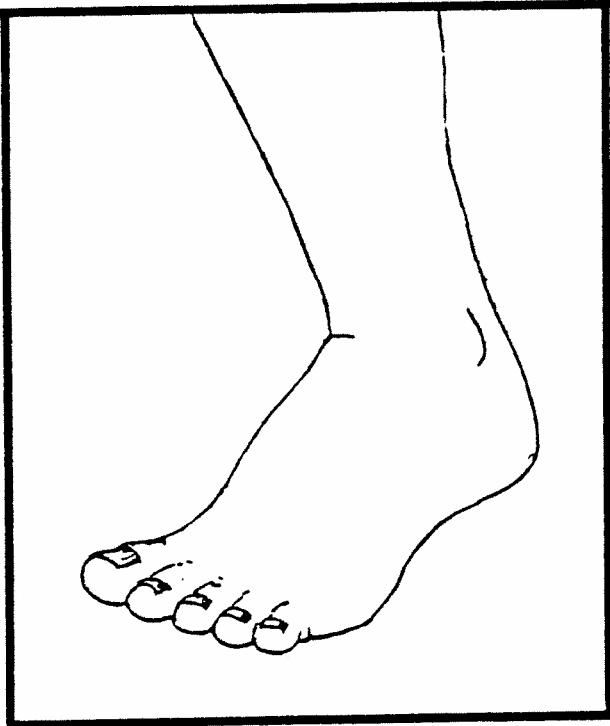

4

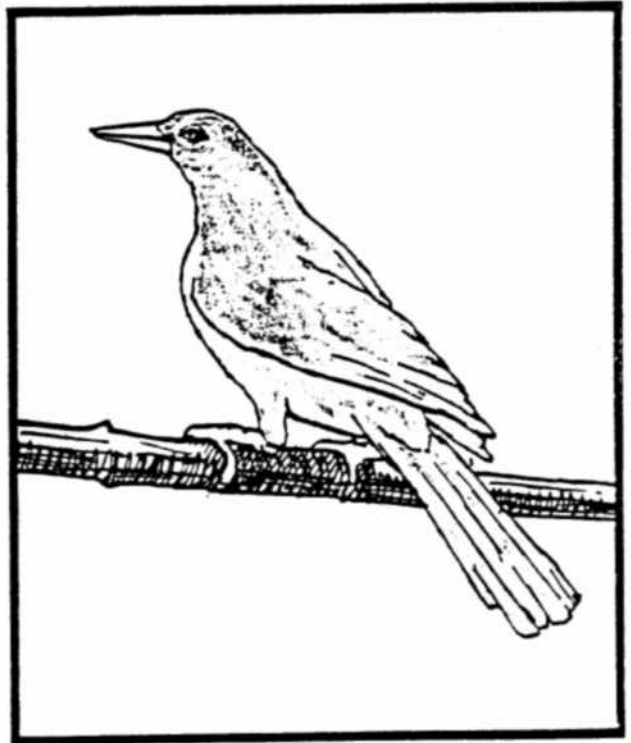

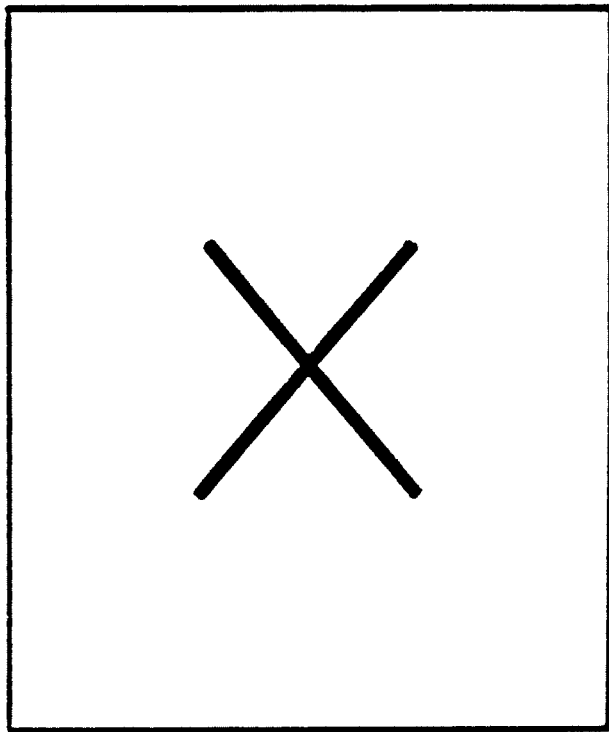

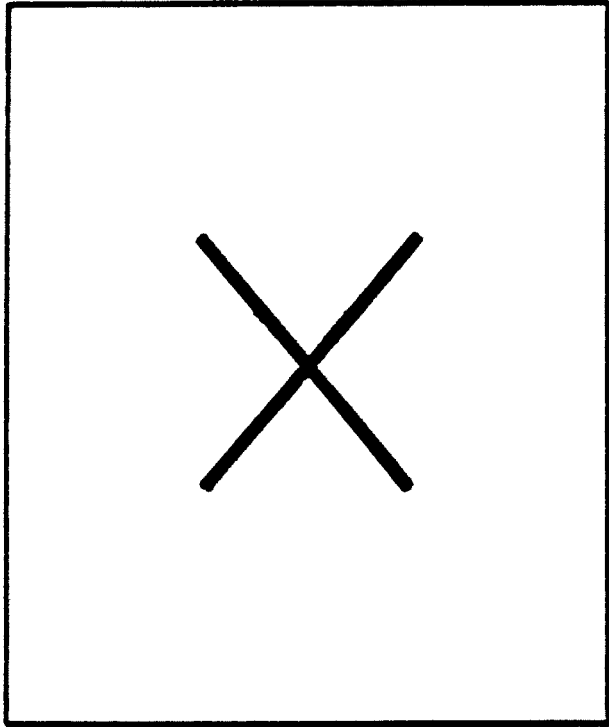

1

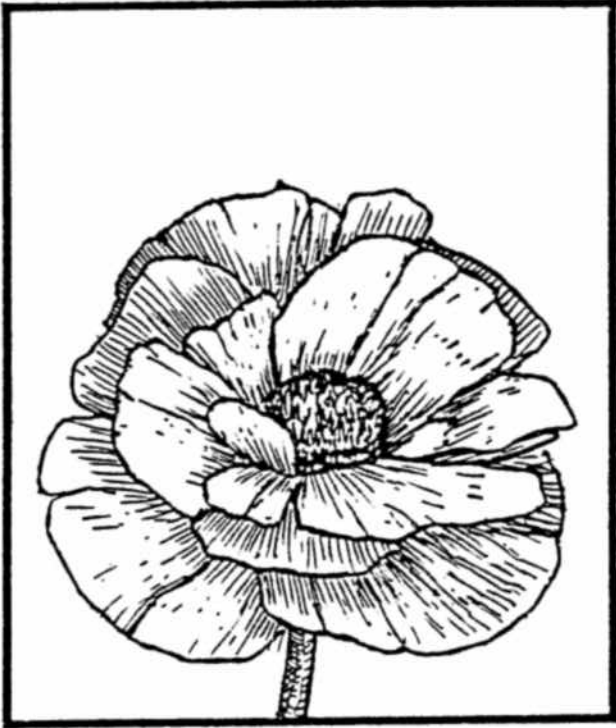

2

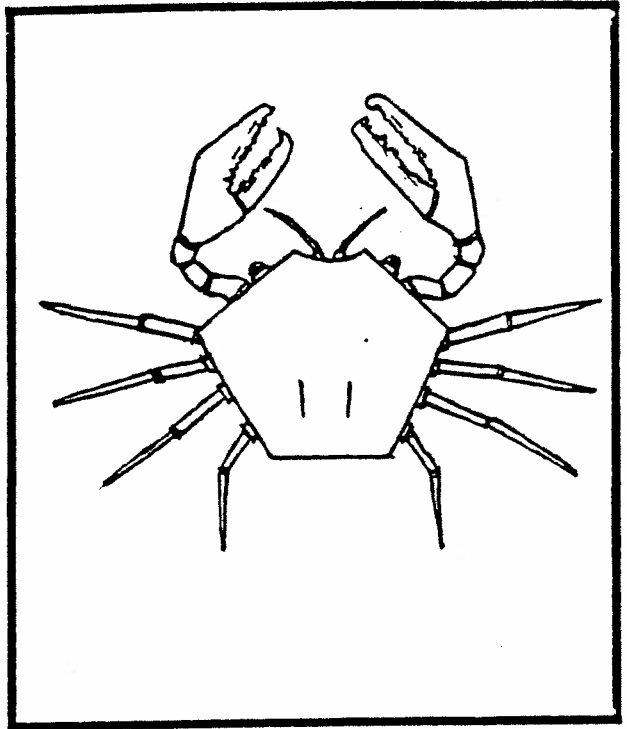

3



4

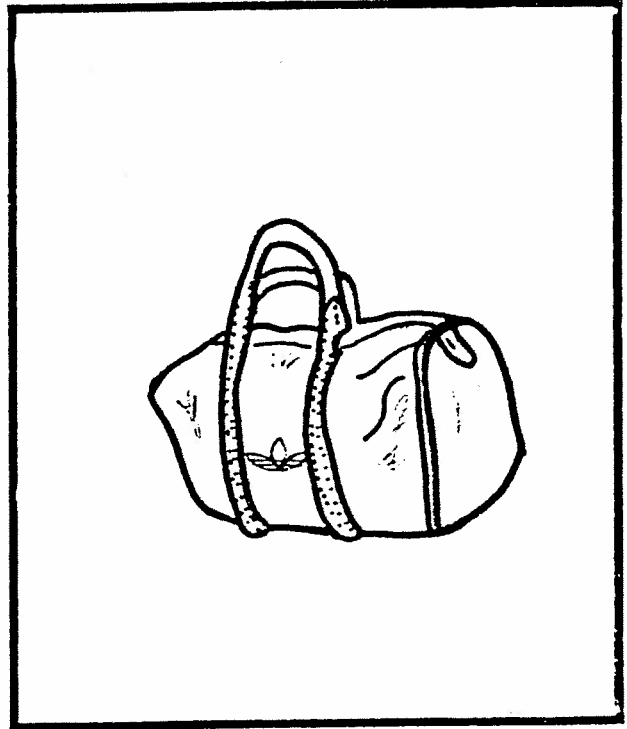

1

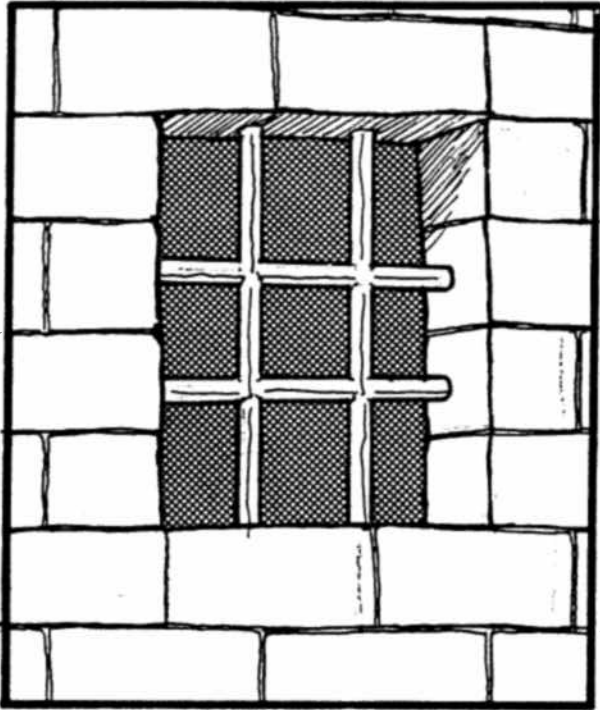

2

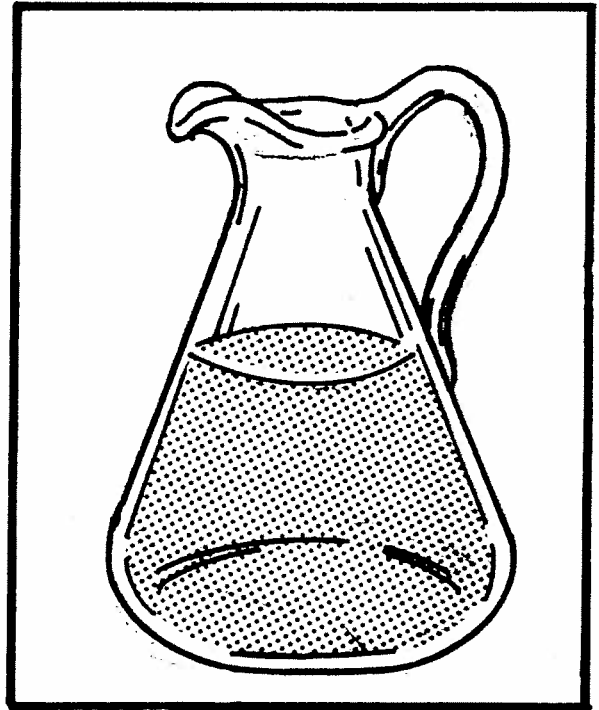

3

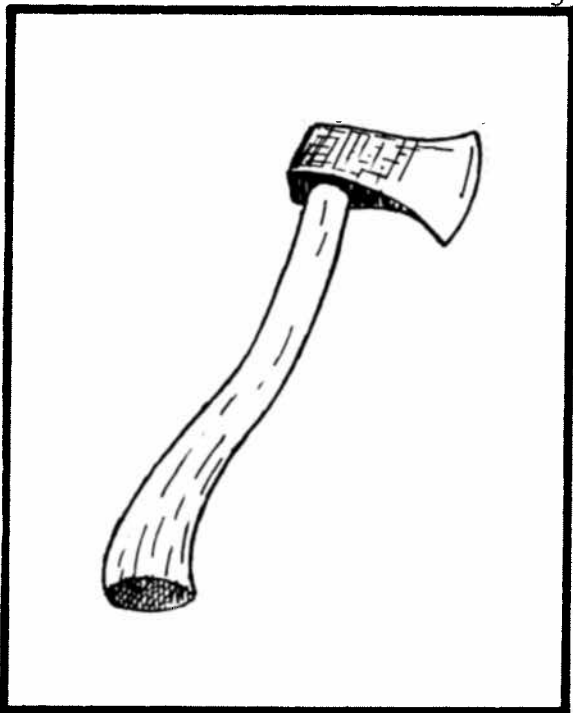

4

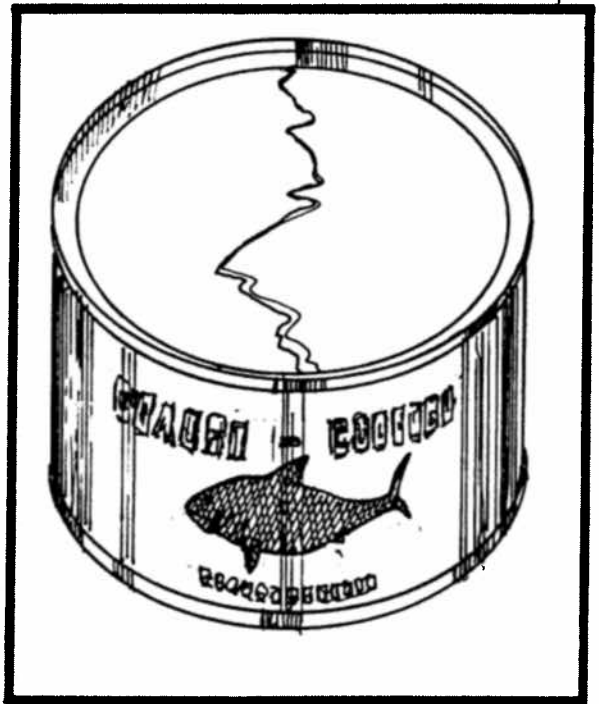

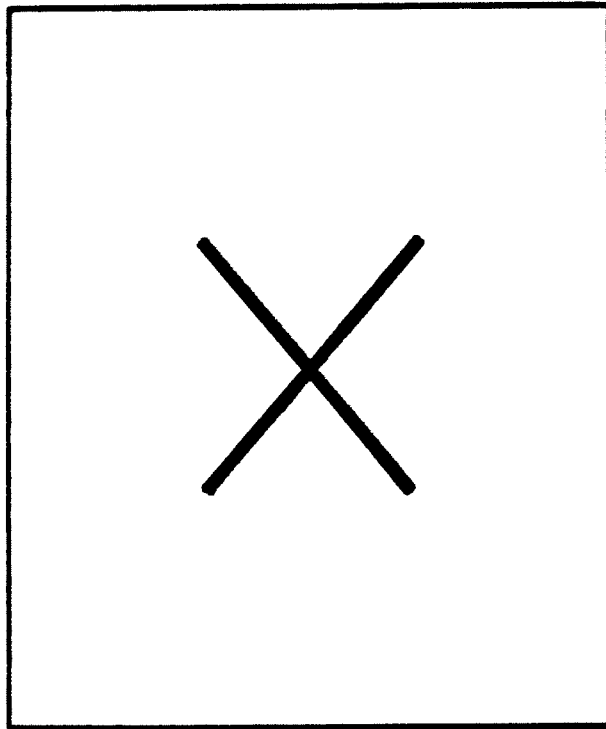

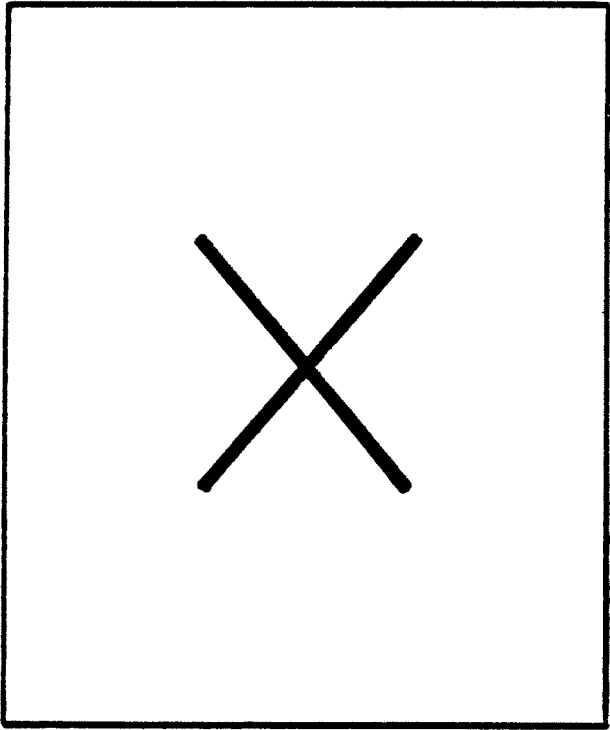

1

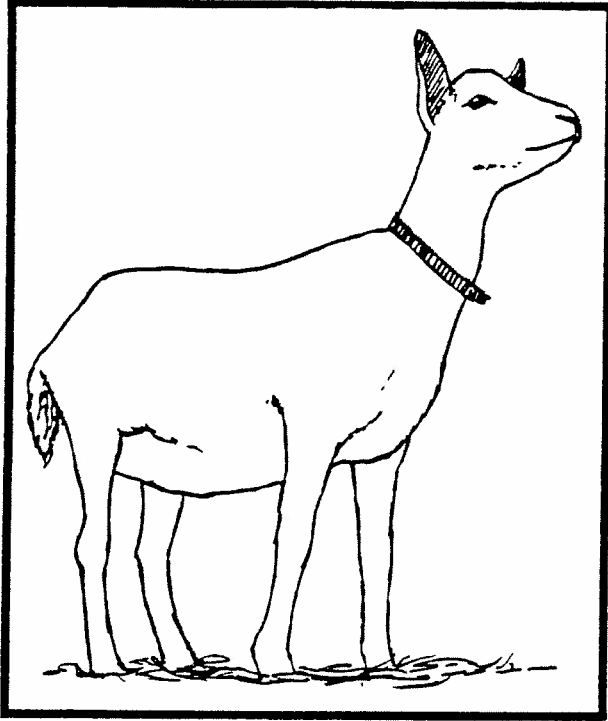

2

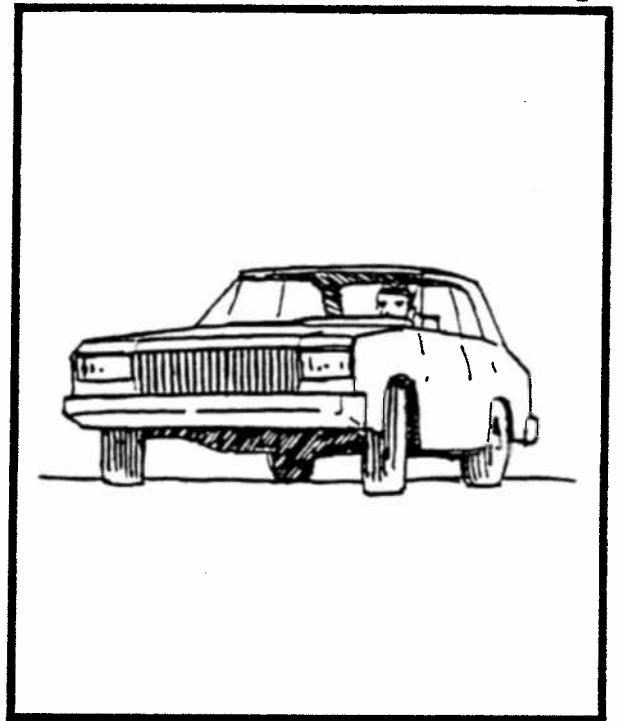

3



4

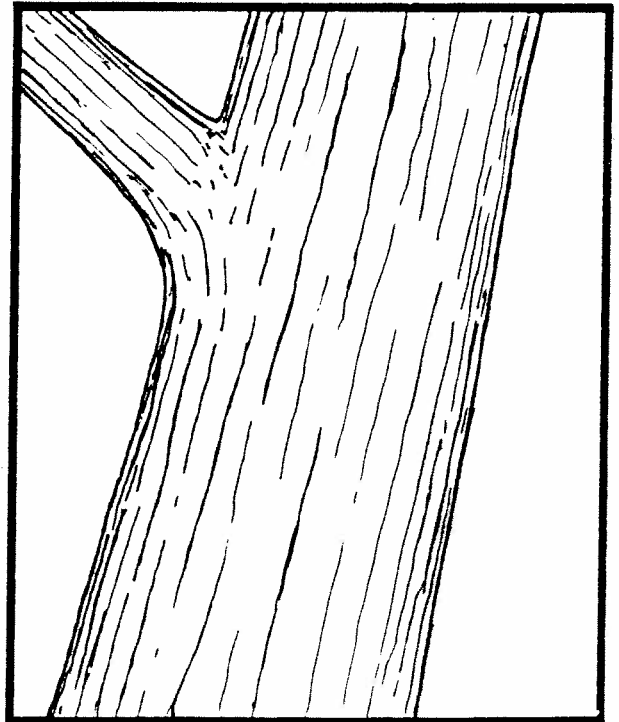

1

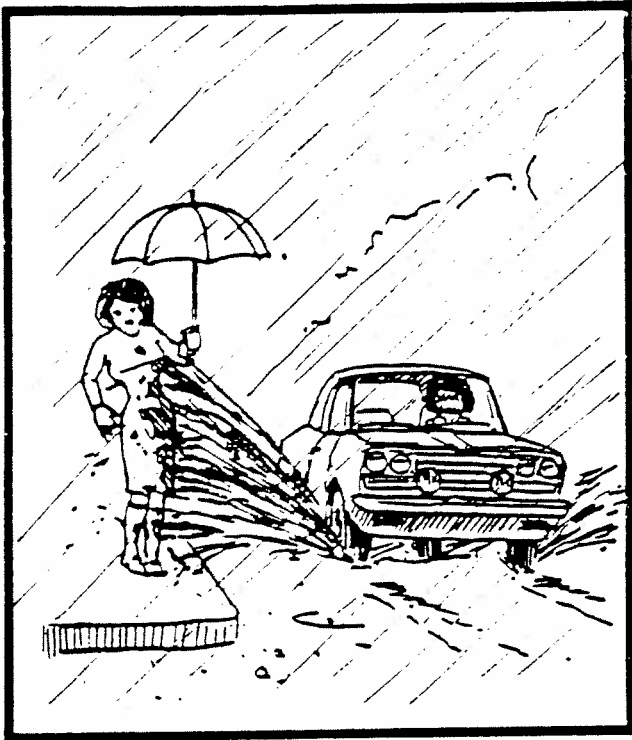

2



3

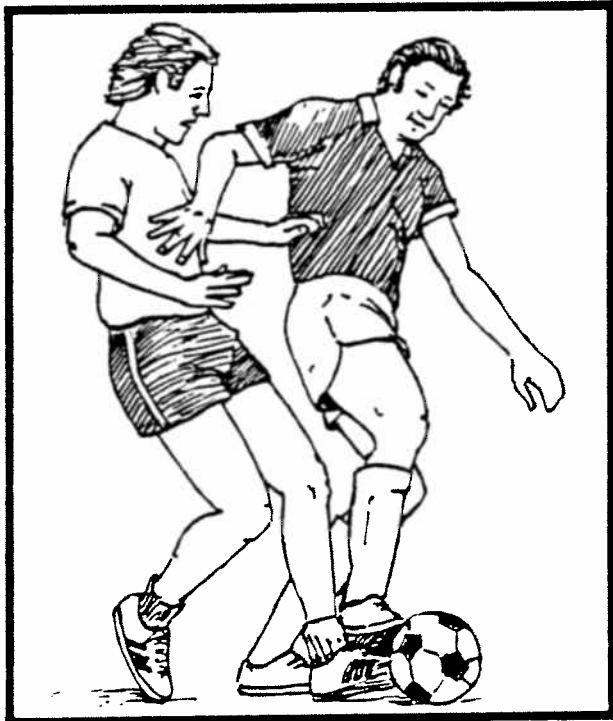

4

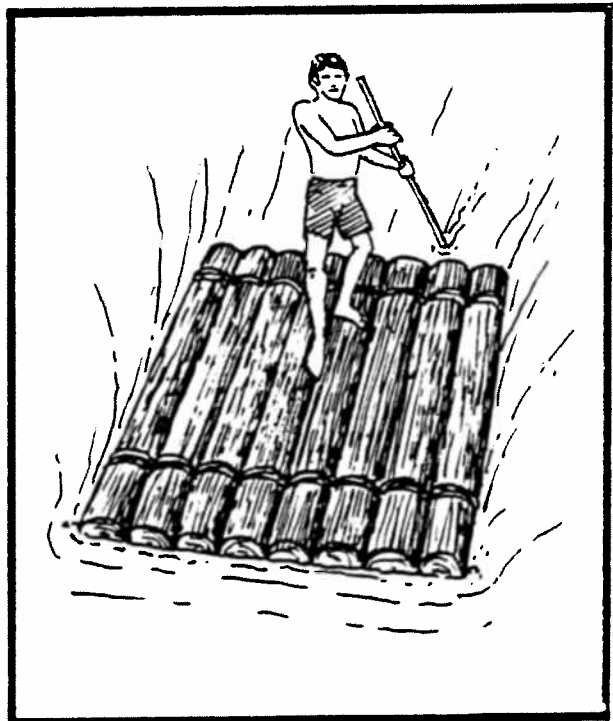

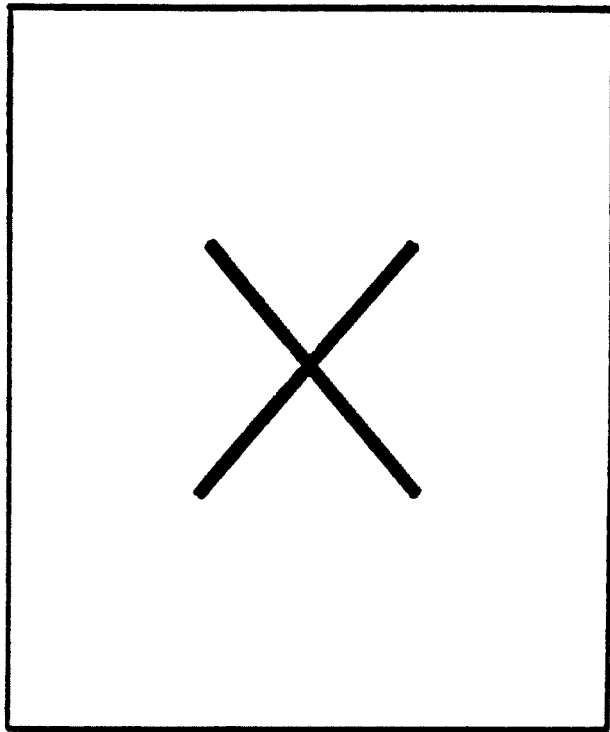

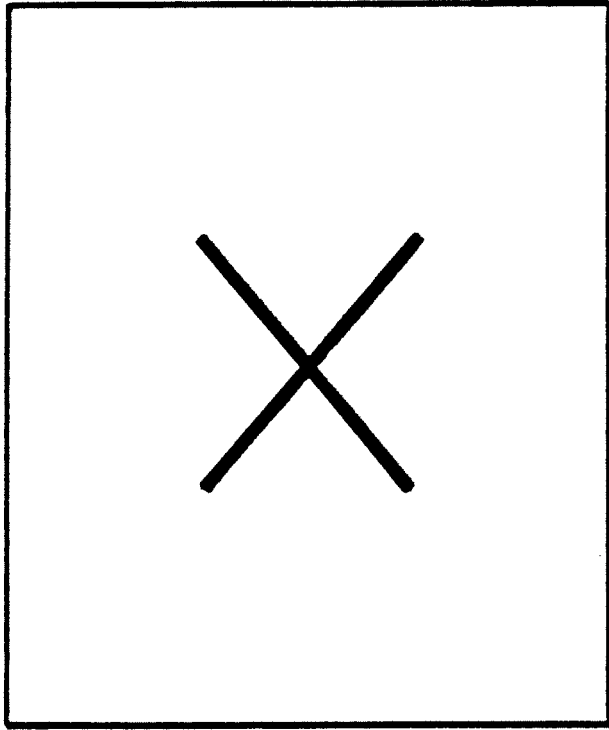

1

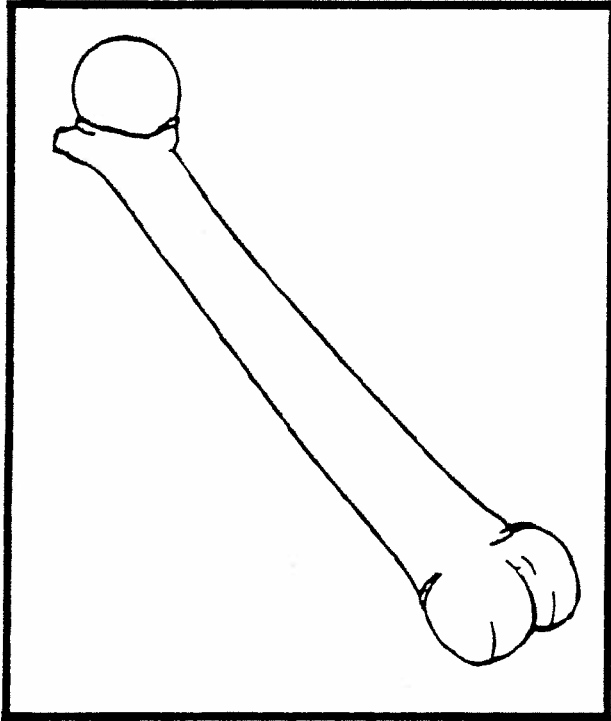

2

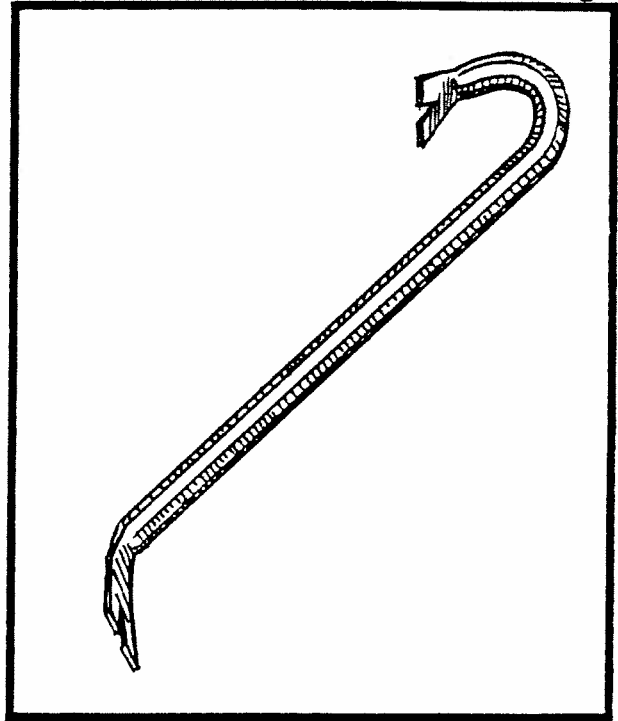

3



4



1

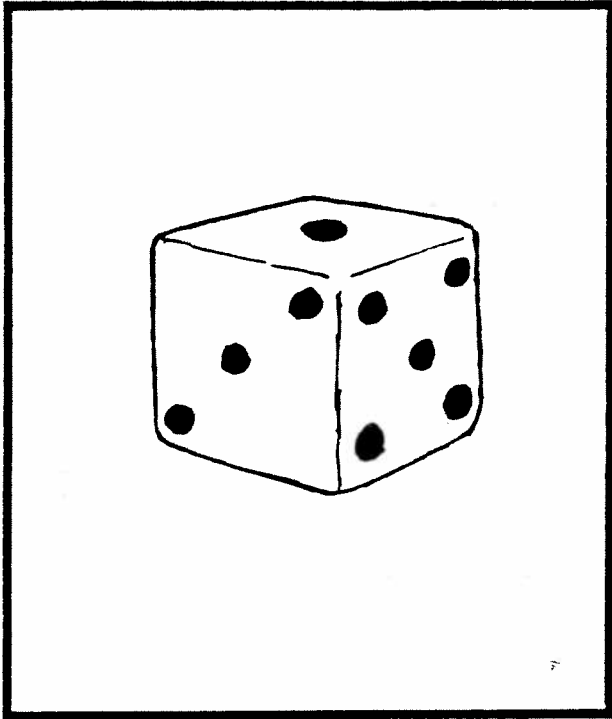

2



3

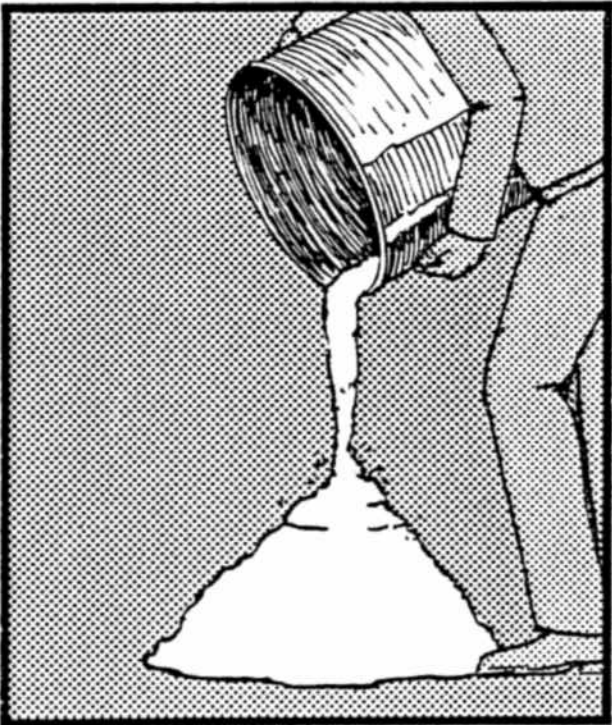

4



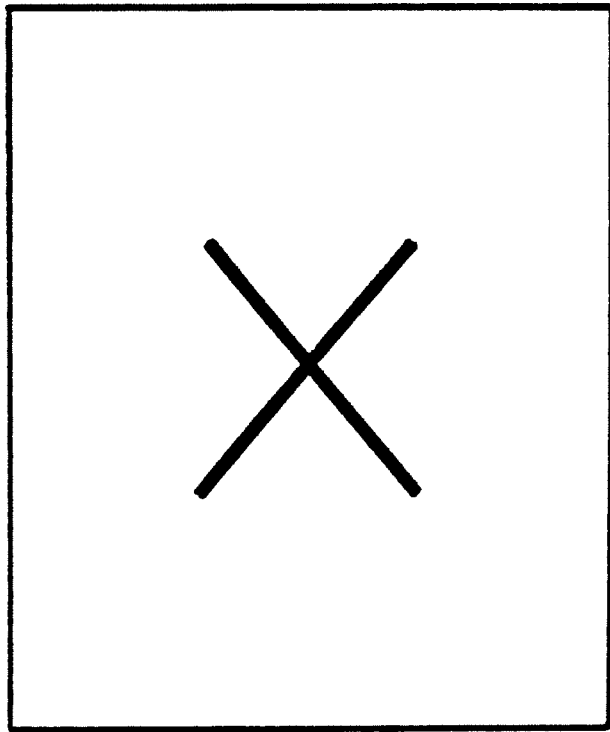

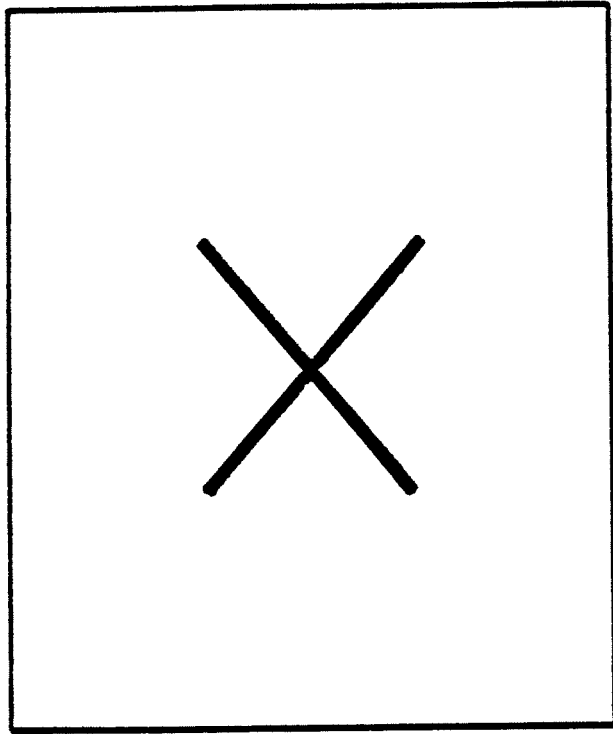

1

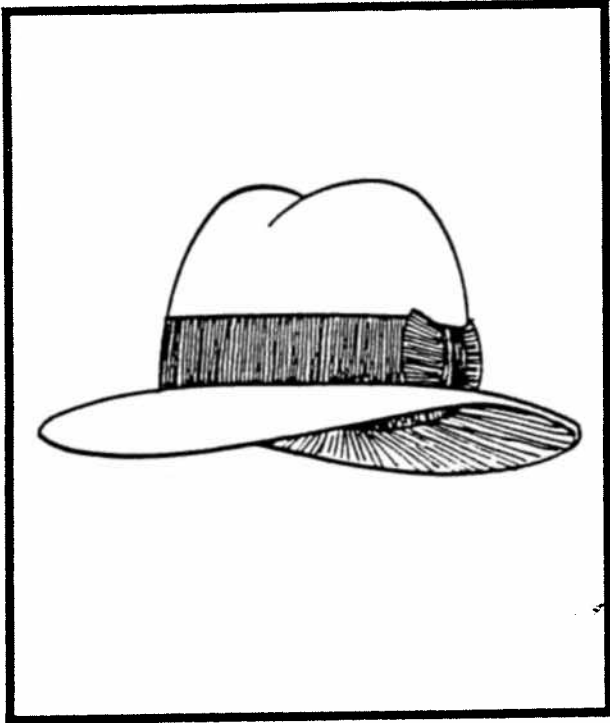

2

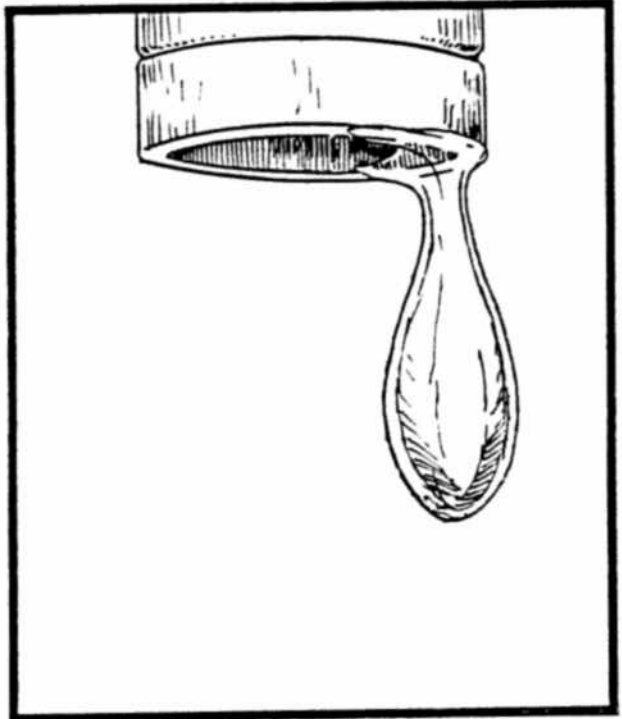

3

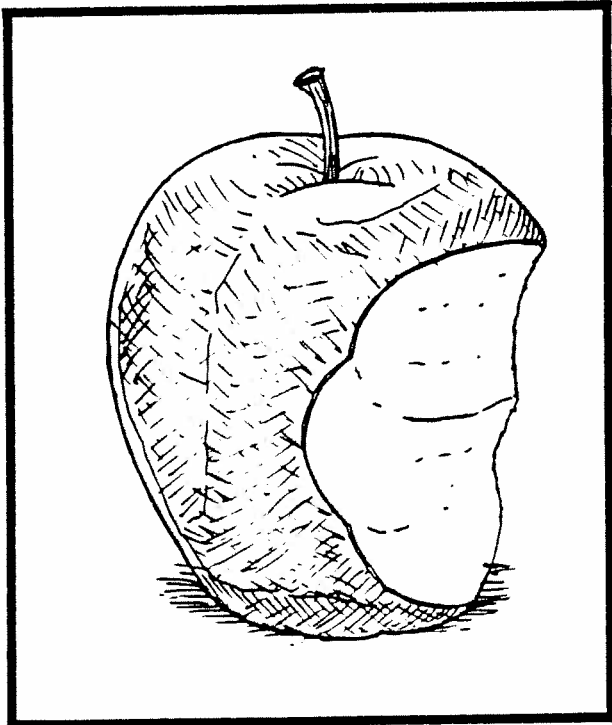

4

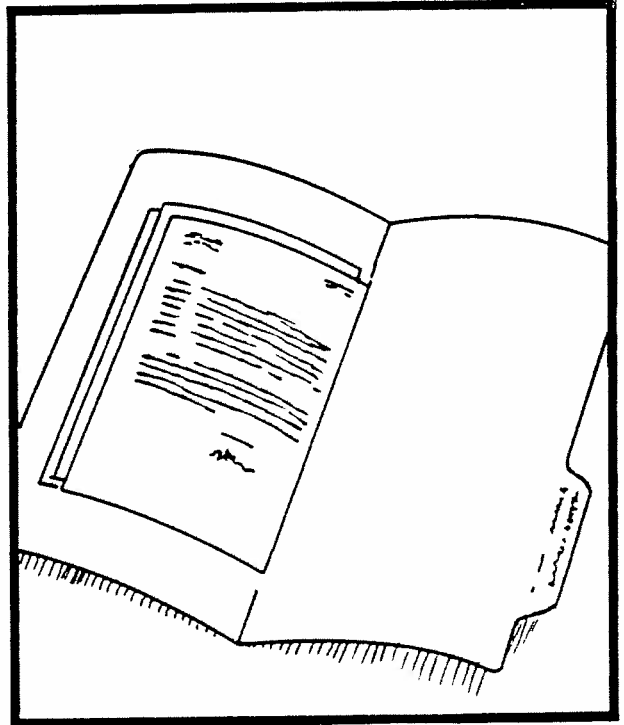

1

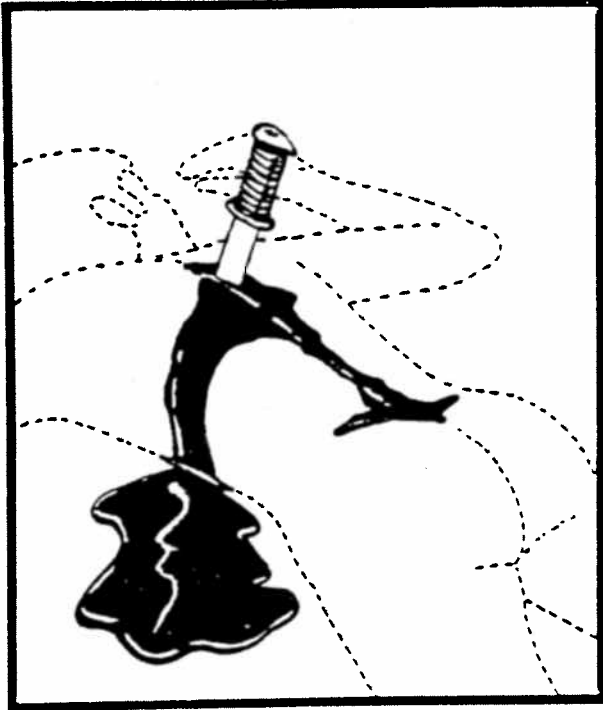

2

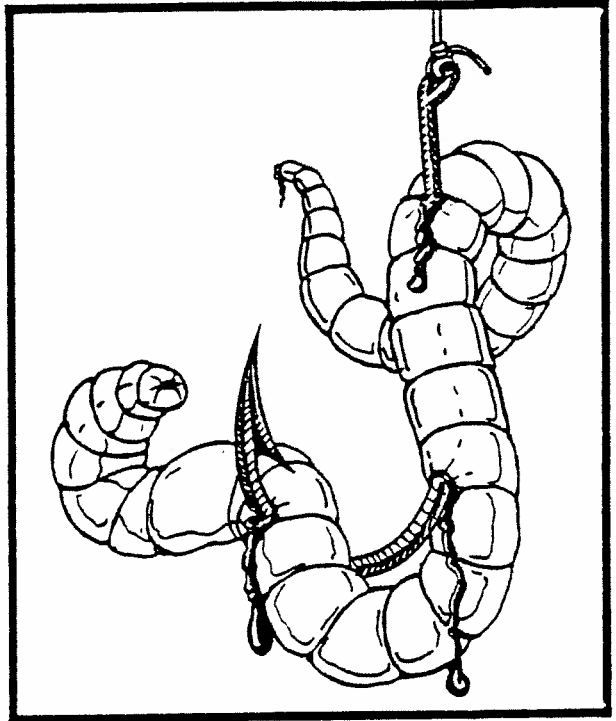

3

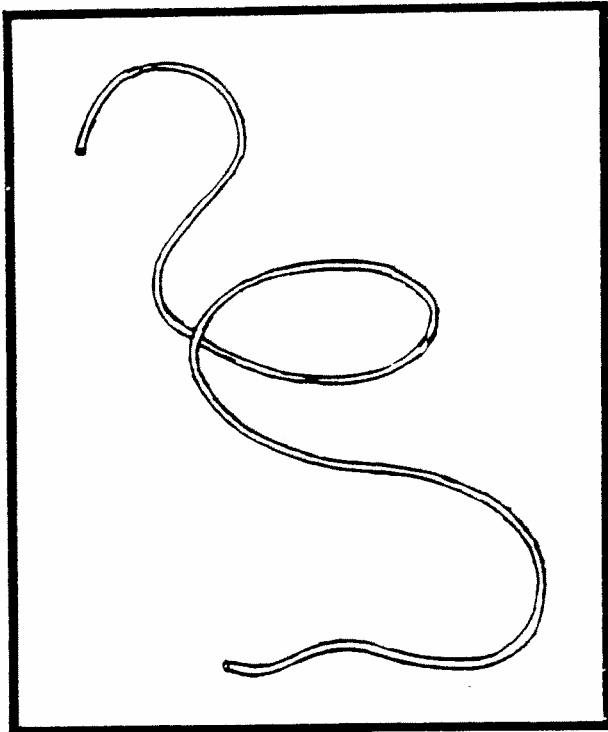

4

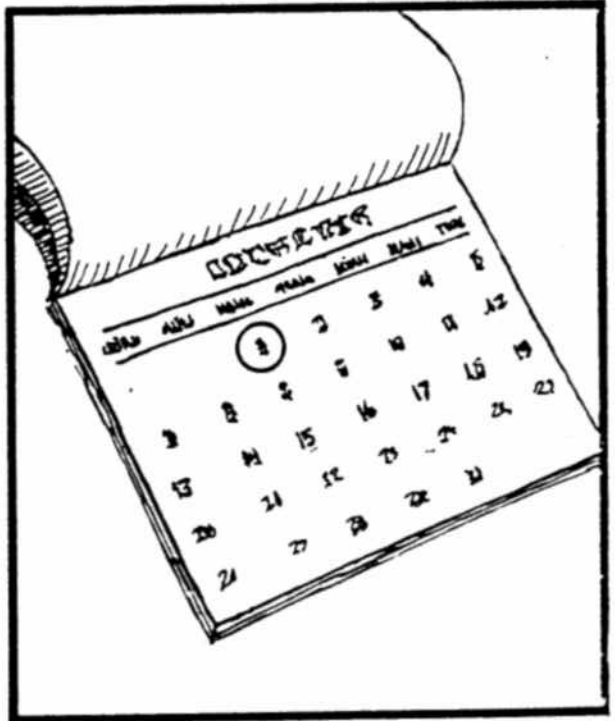

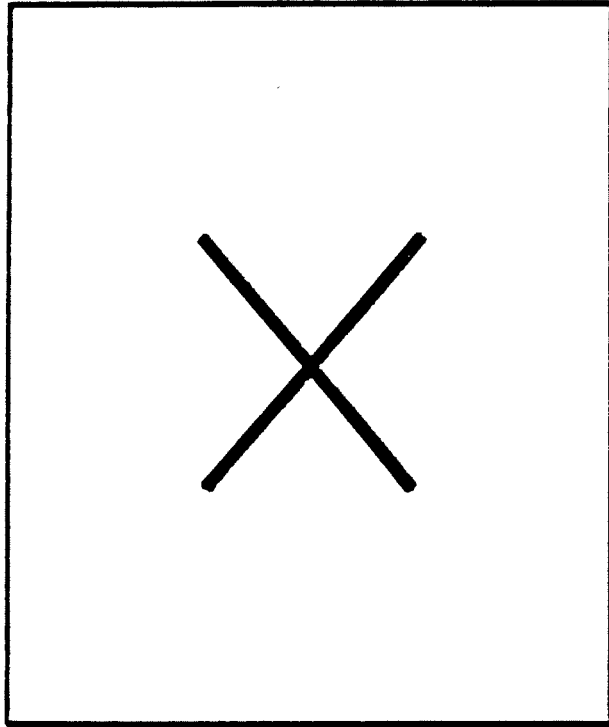

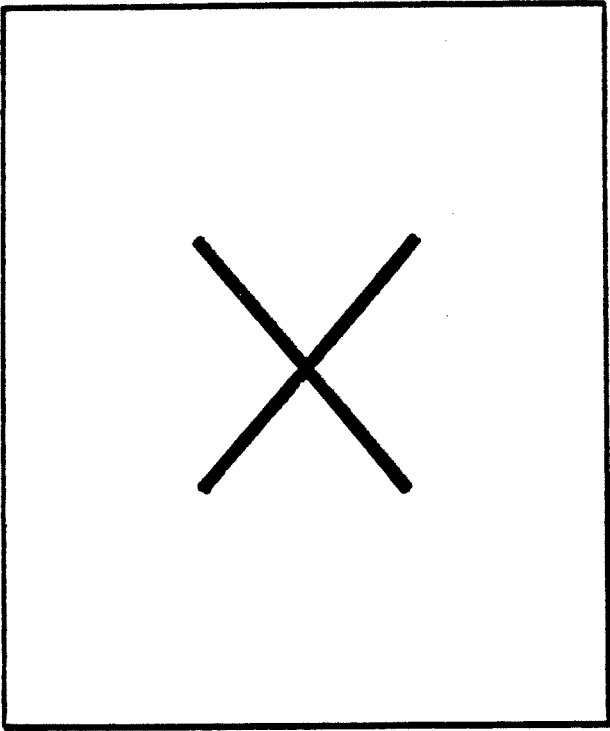

1

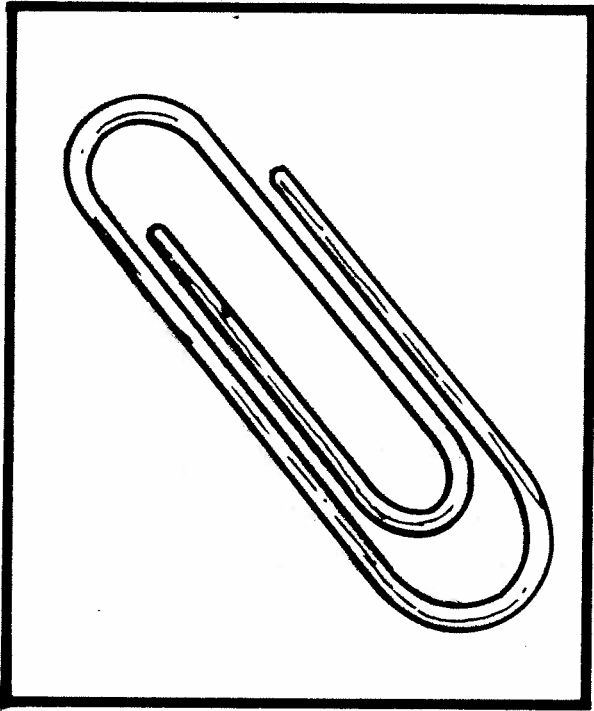

2

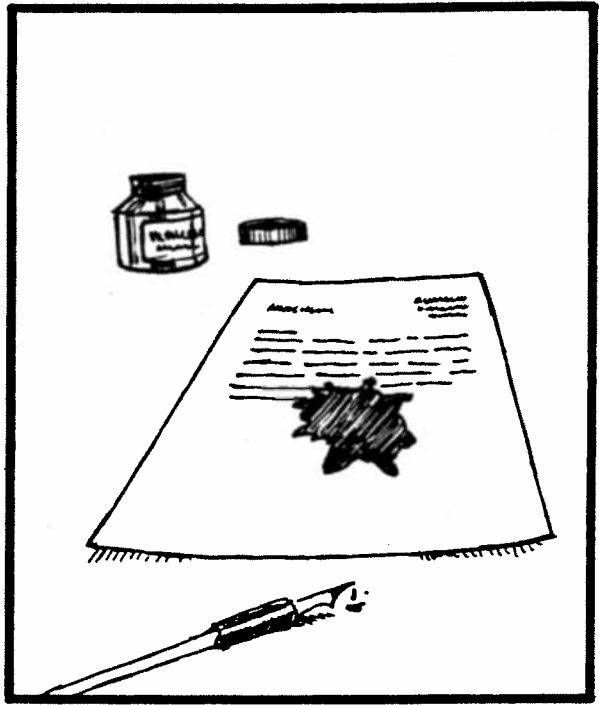

3

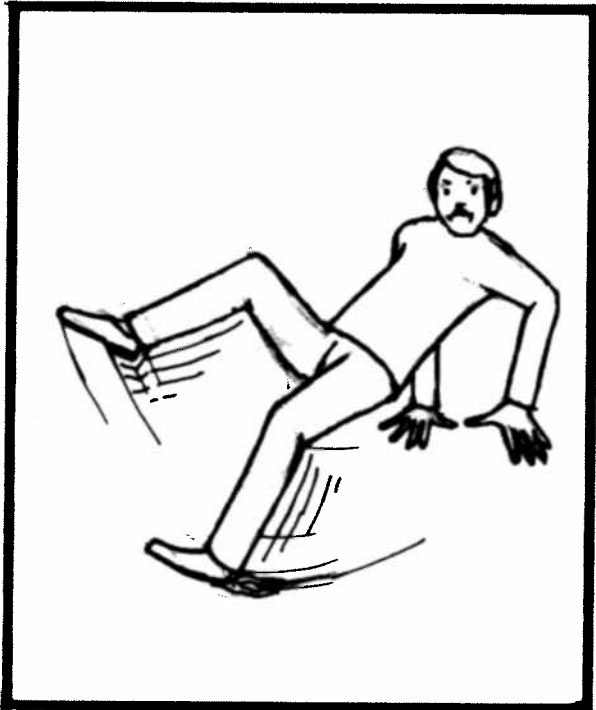

4

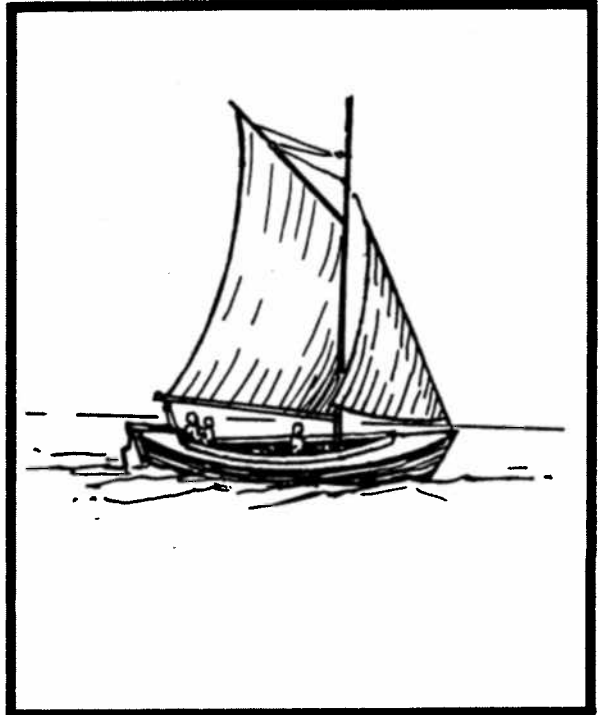

1

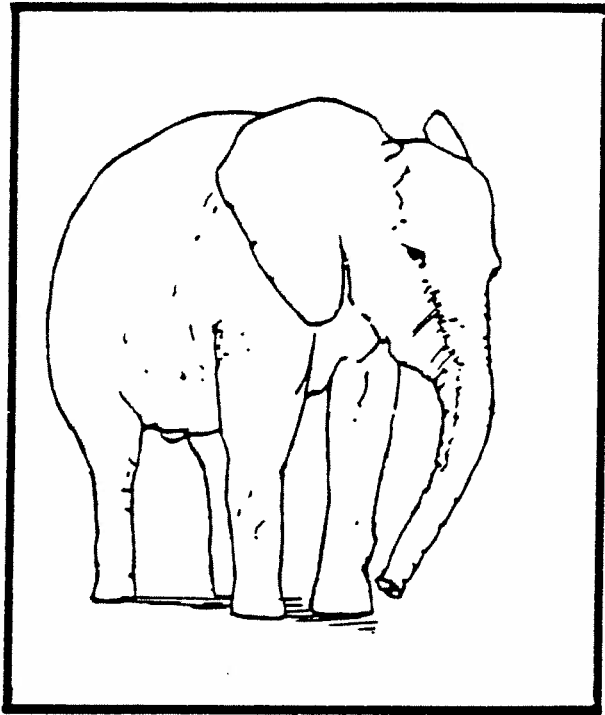

2

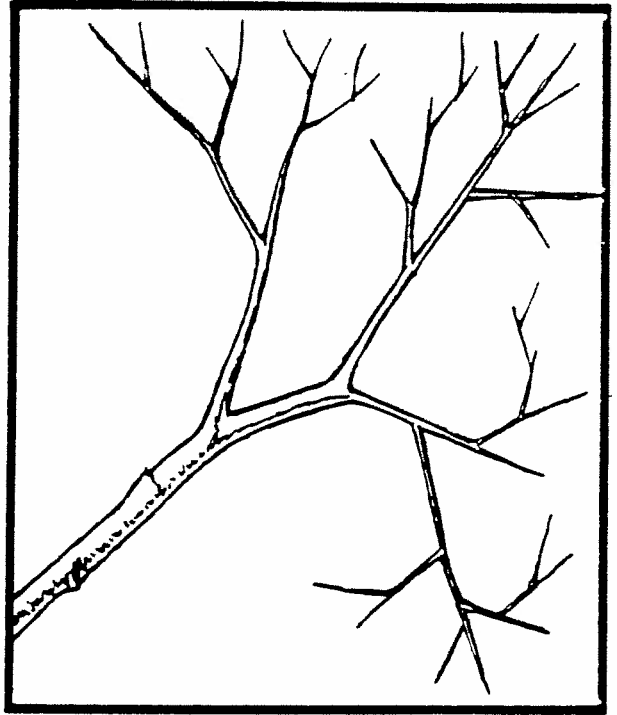

3

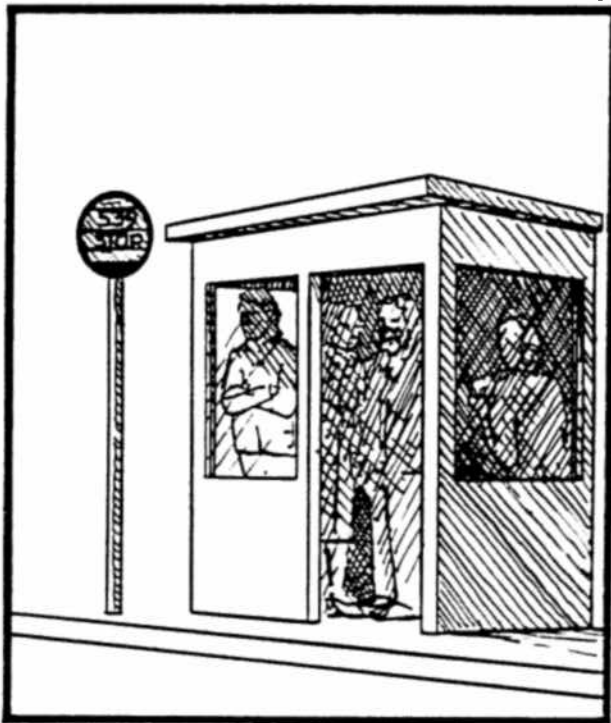

4



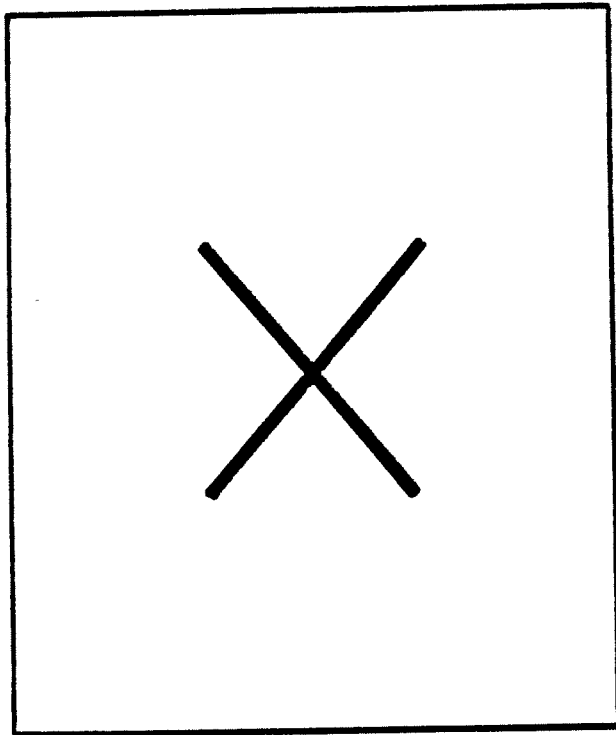

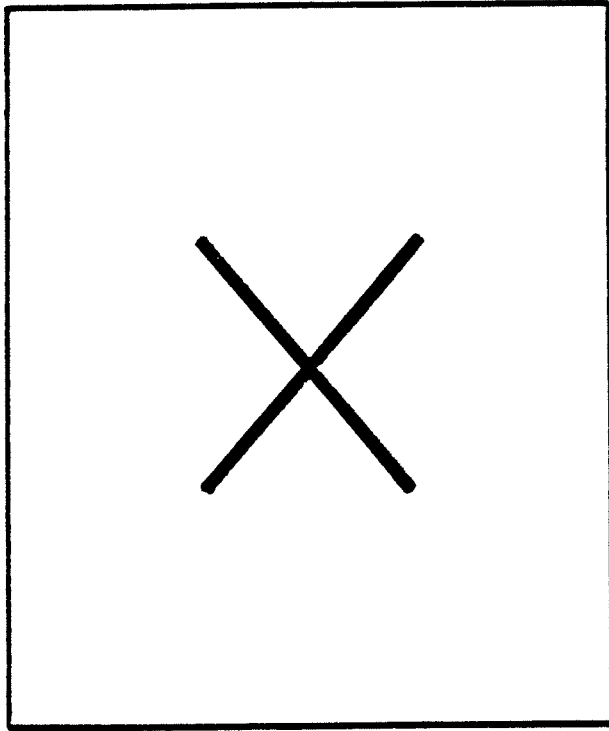

1

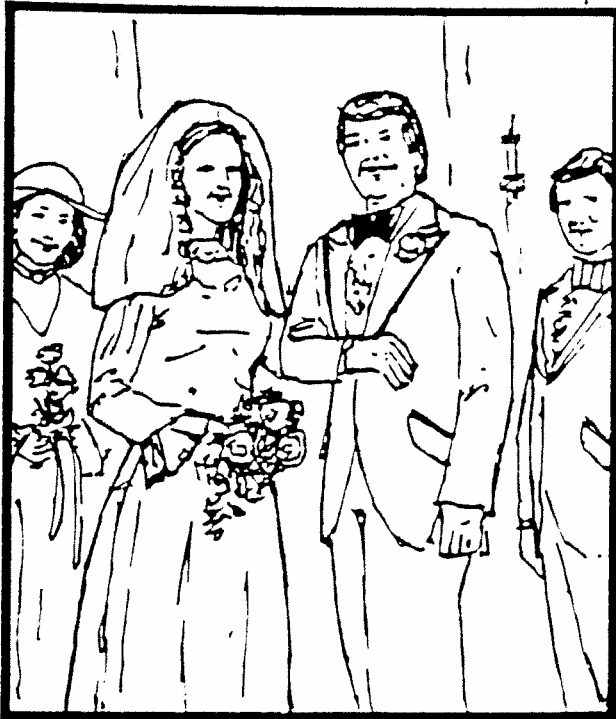

2

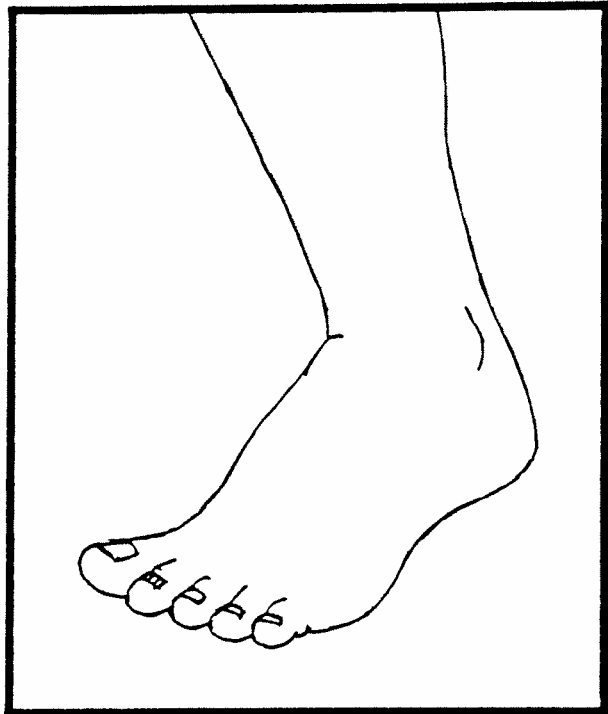

3



4

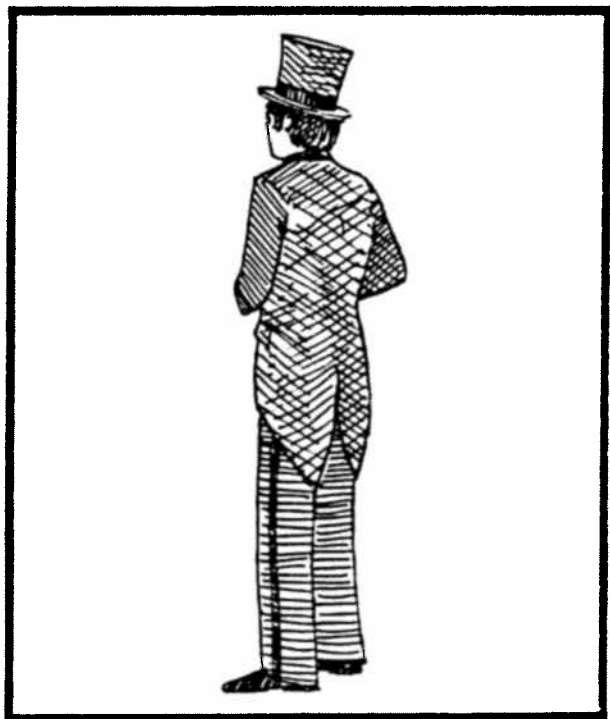

1

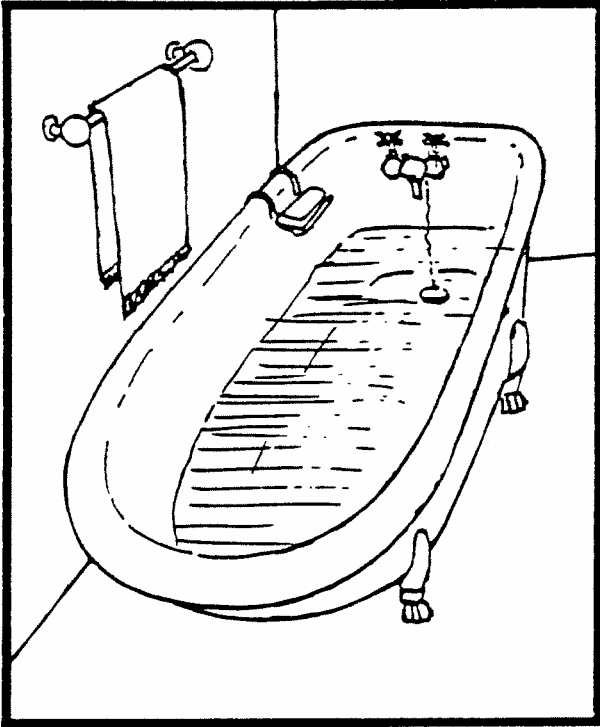

2

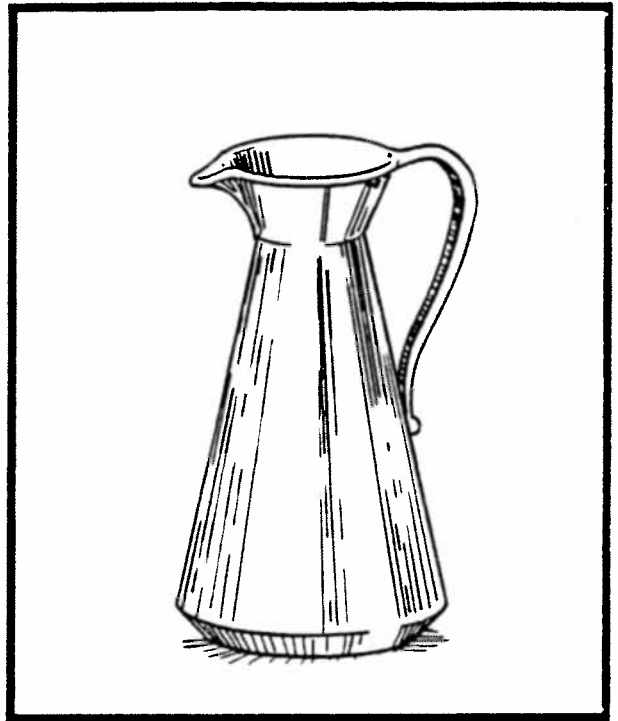

3

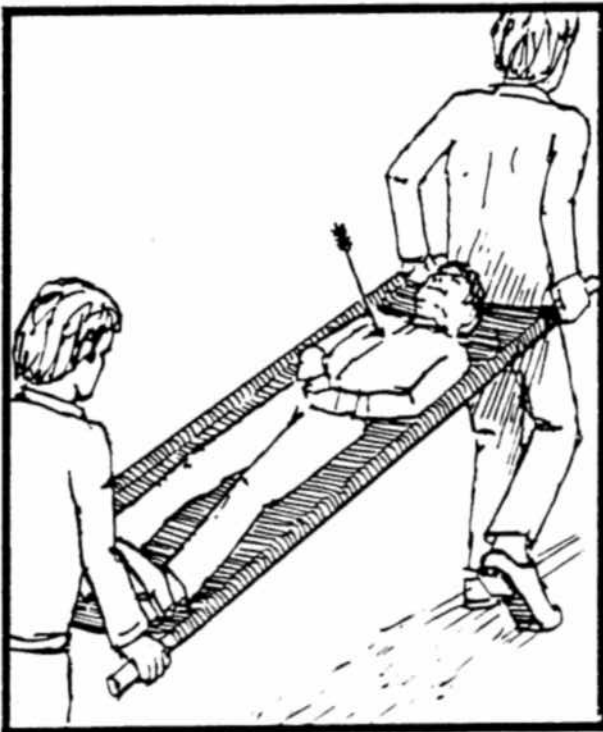

4

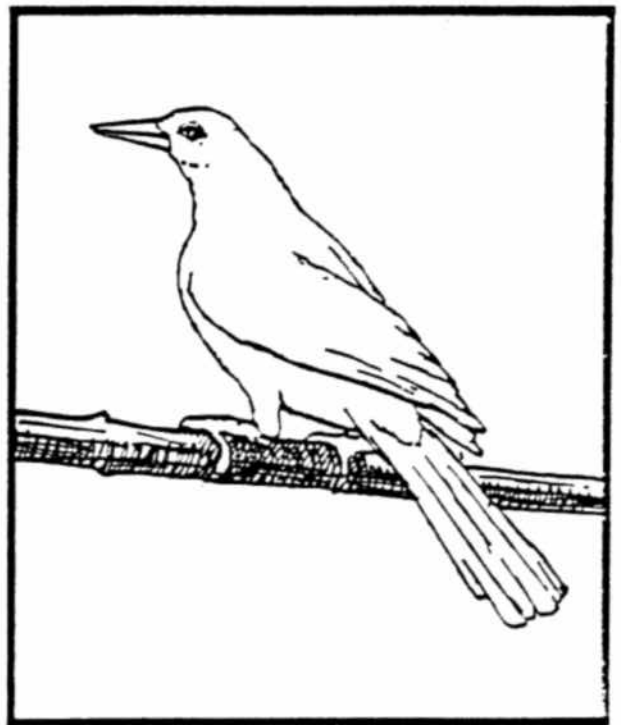

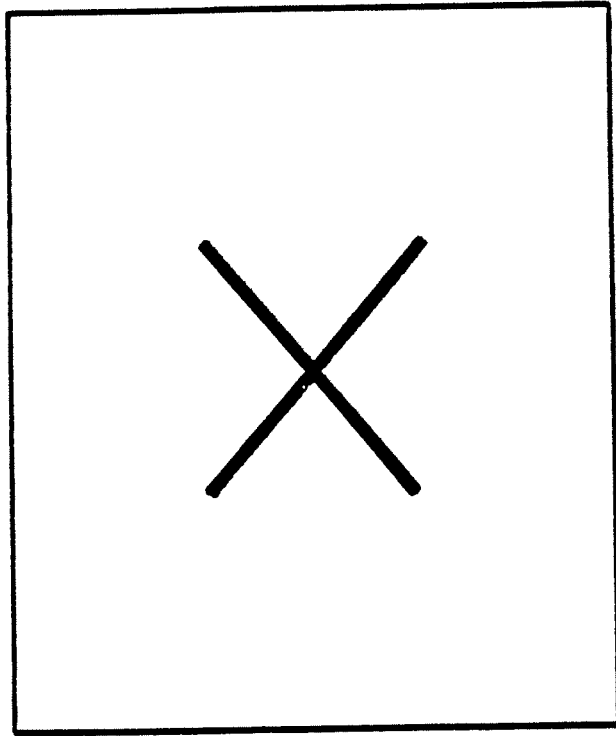

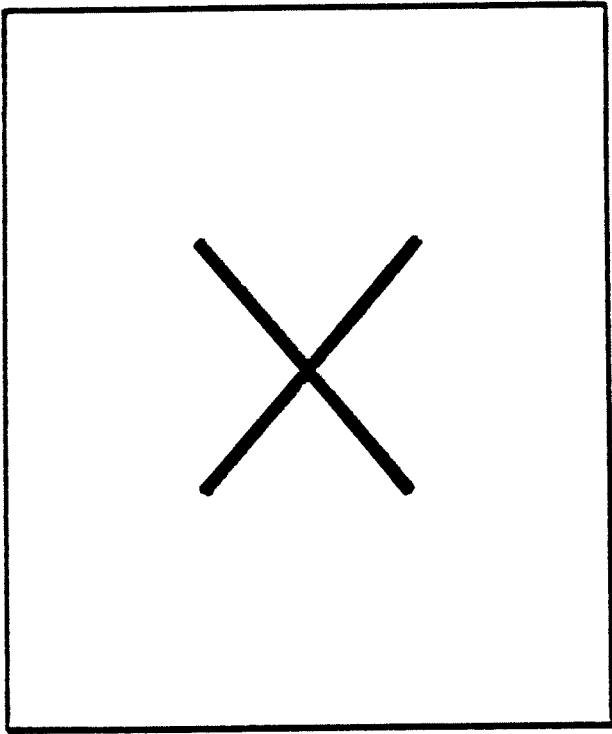

1

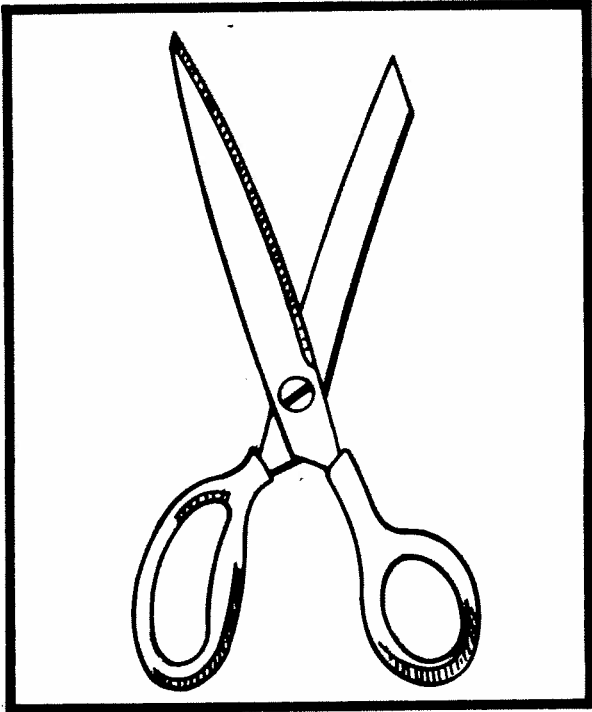

2

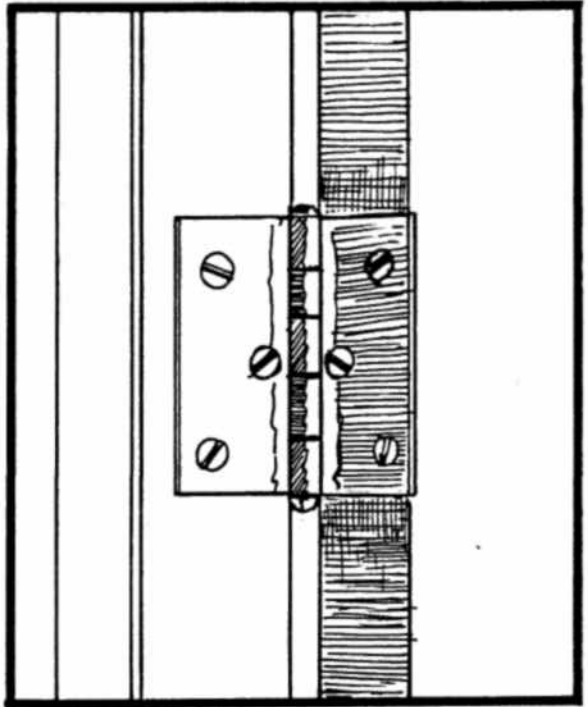

3



4

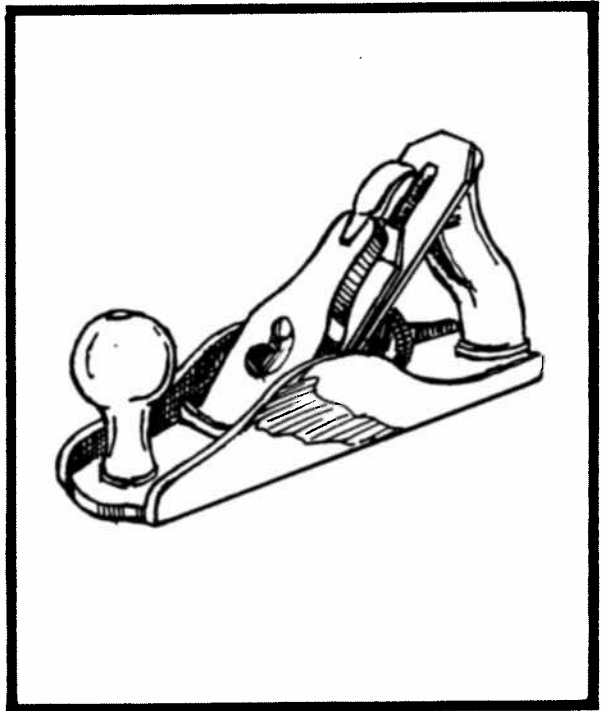

1

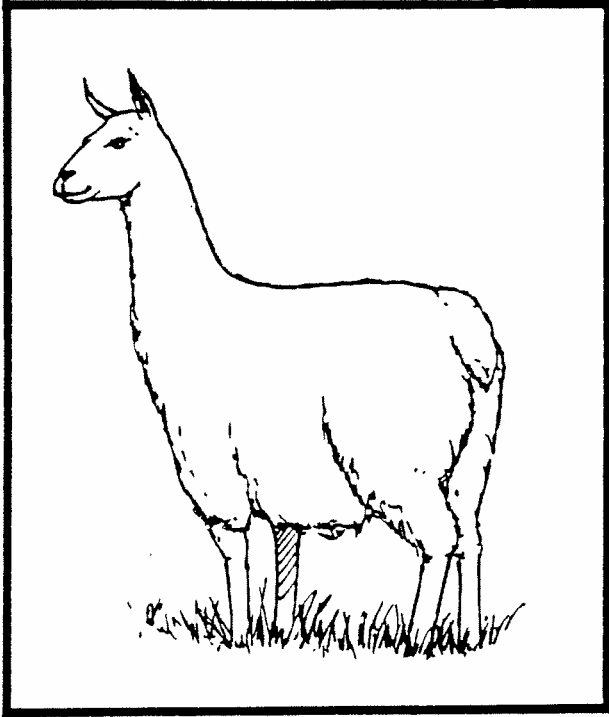

2

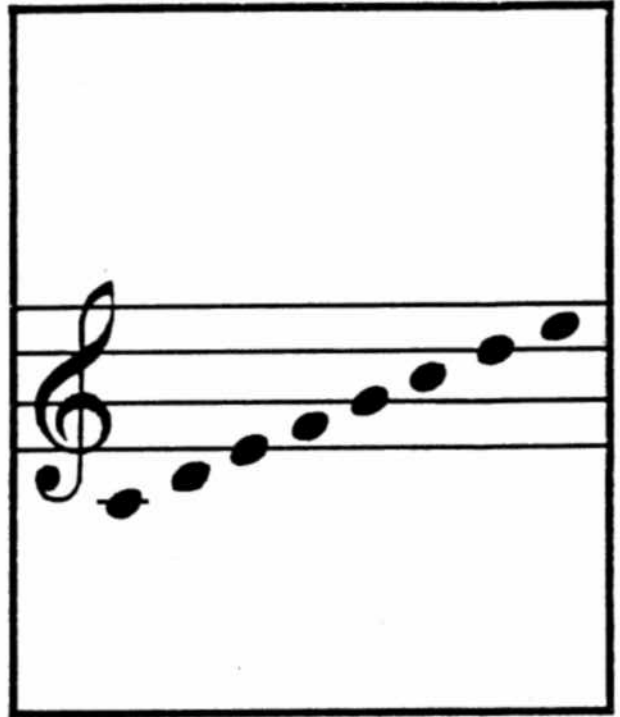

3



4

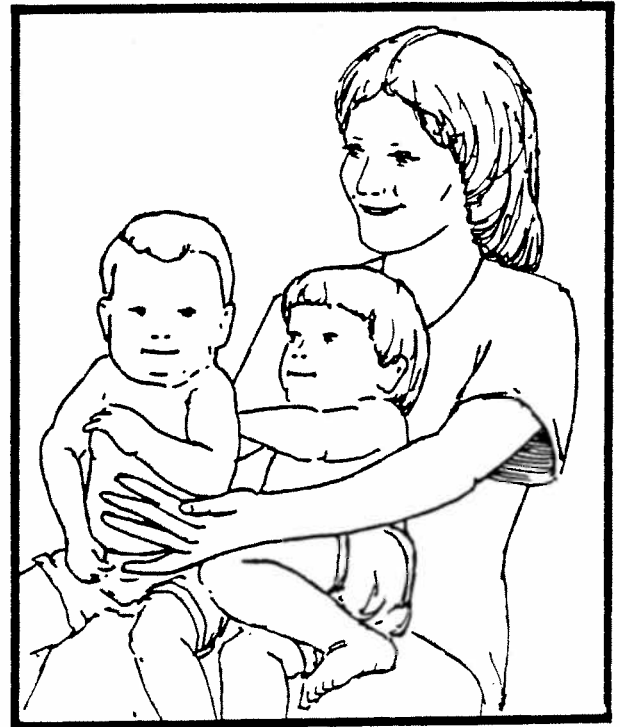

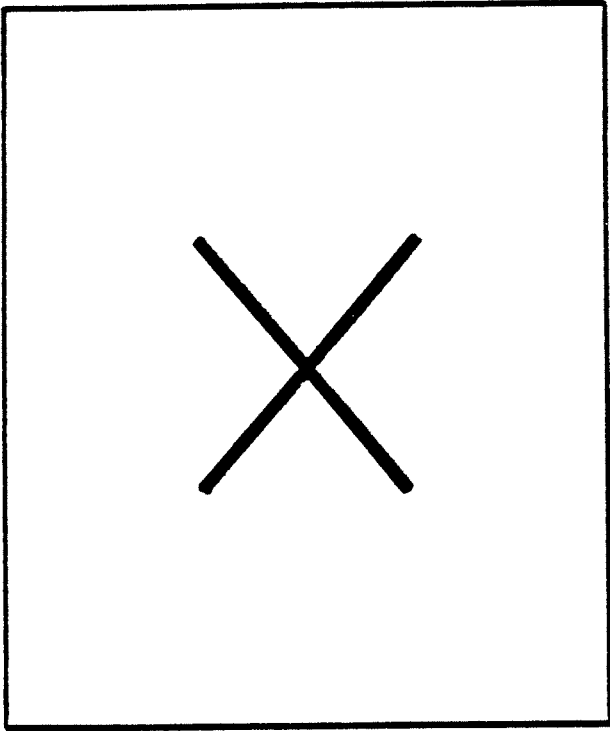

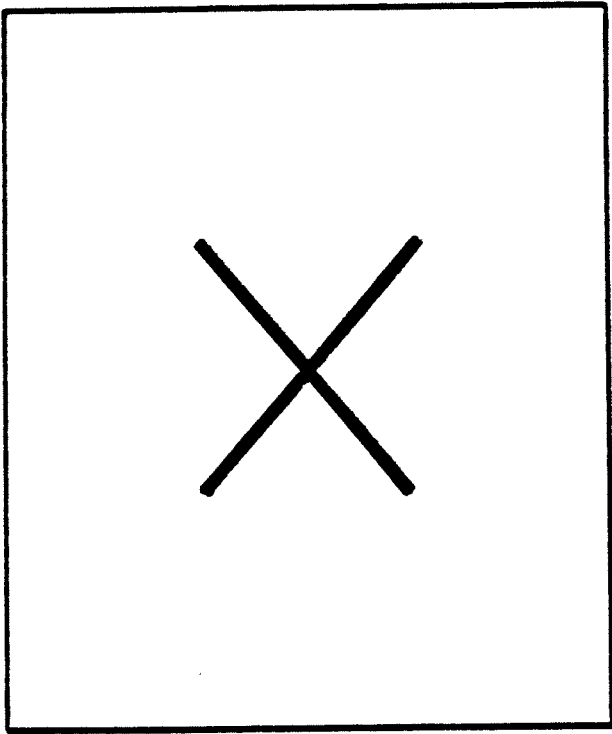

1

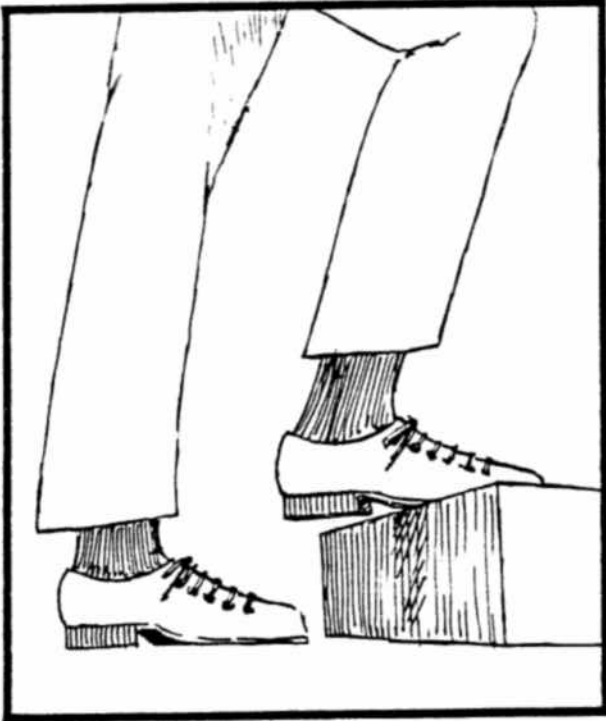

2



3



4



1

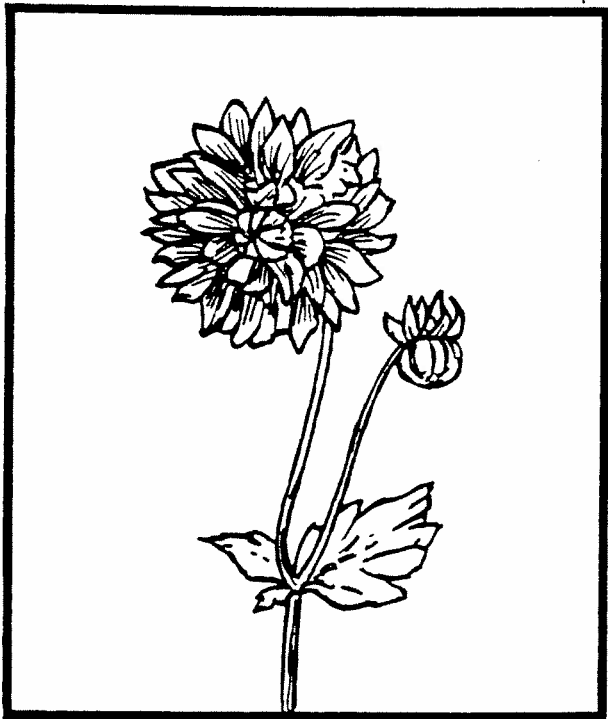

2

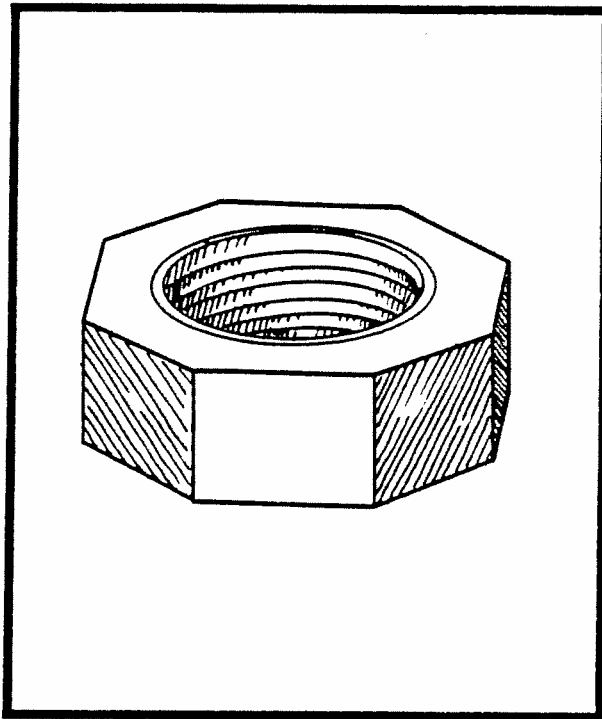

3

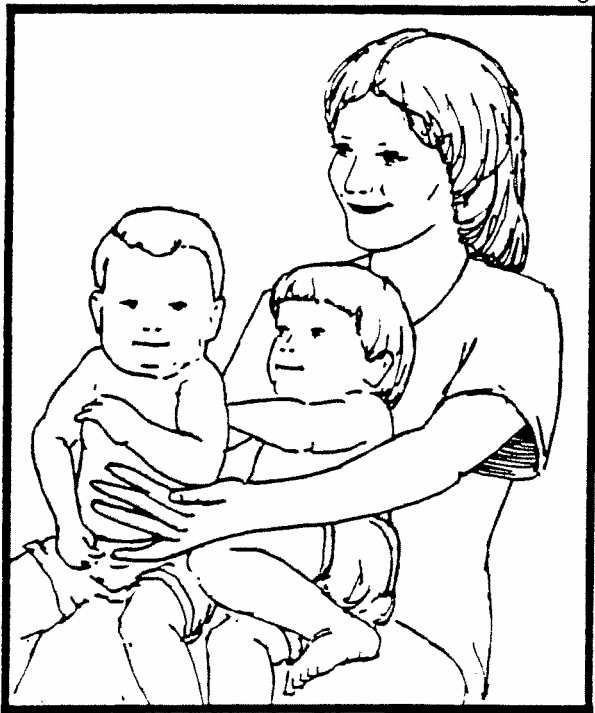

4

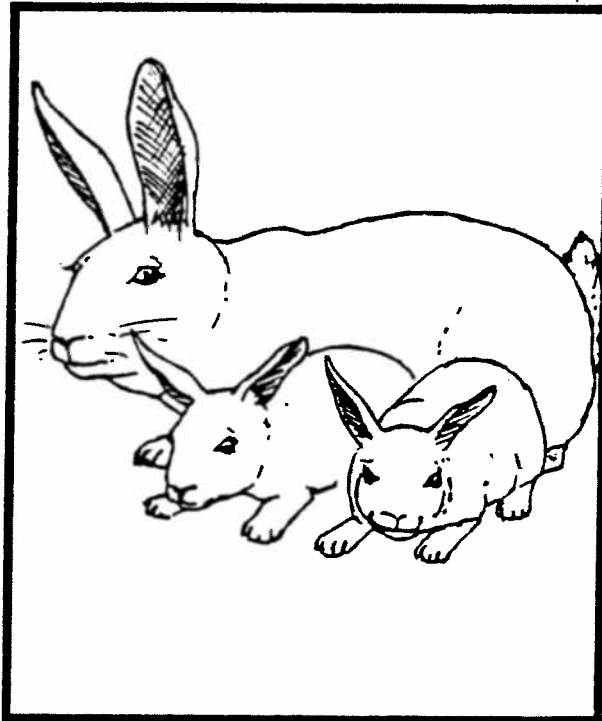

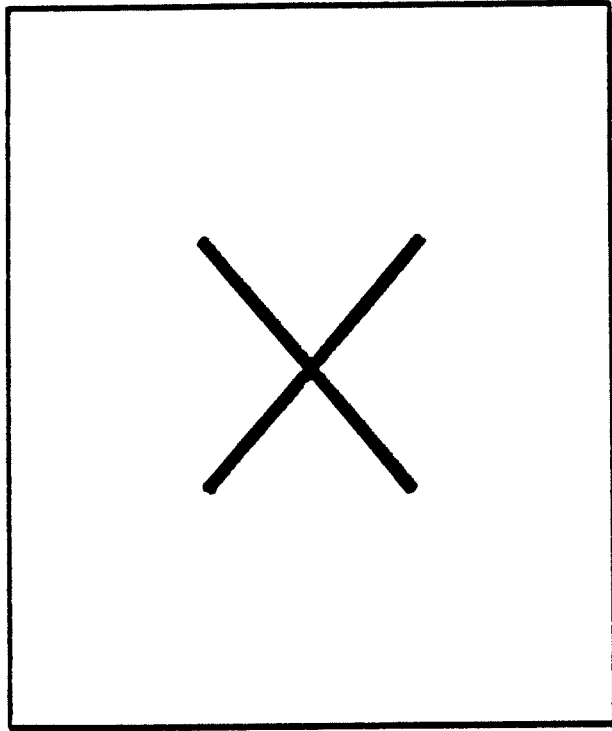

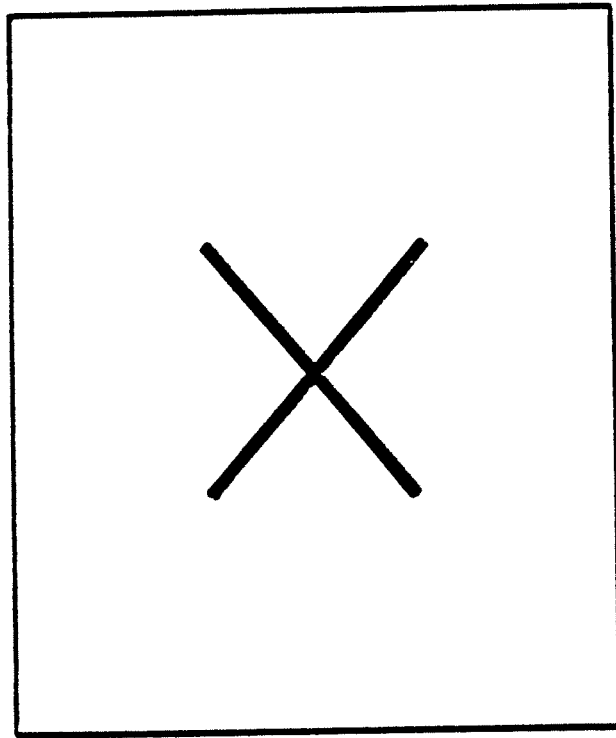

1

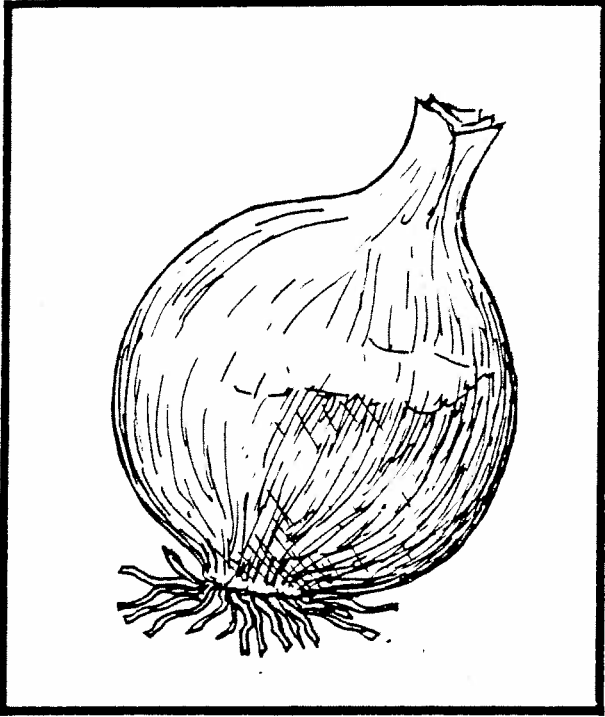

2

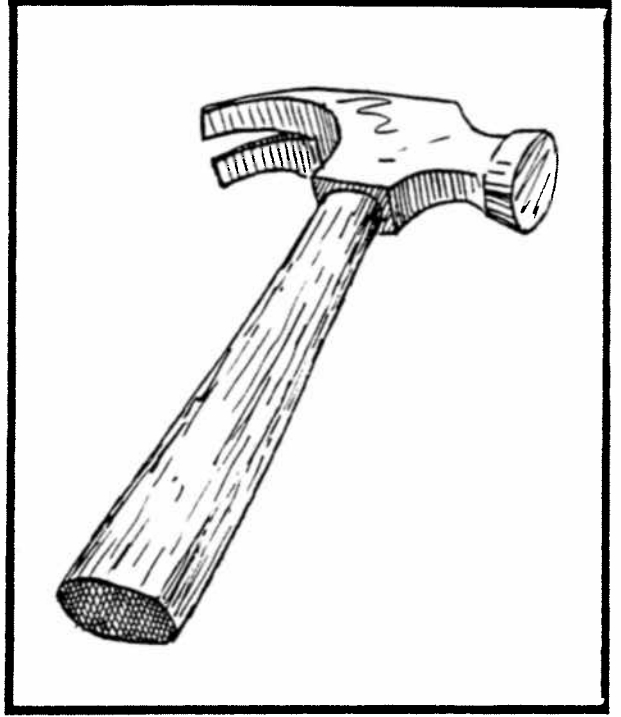

3

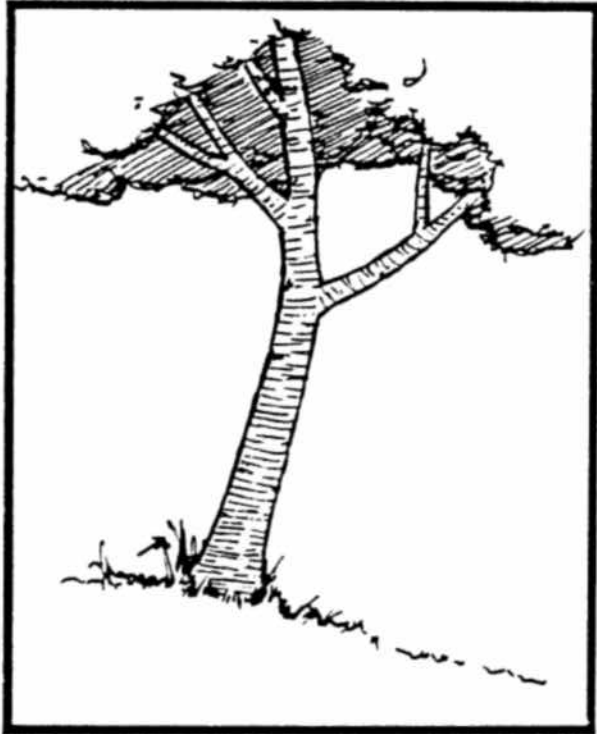

4



РИСУНКИ

СХВАЩАНЕ НА СИНТАКТИЧНИ СТРУКТОРИ

1

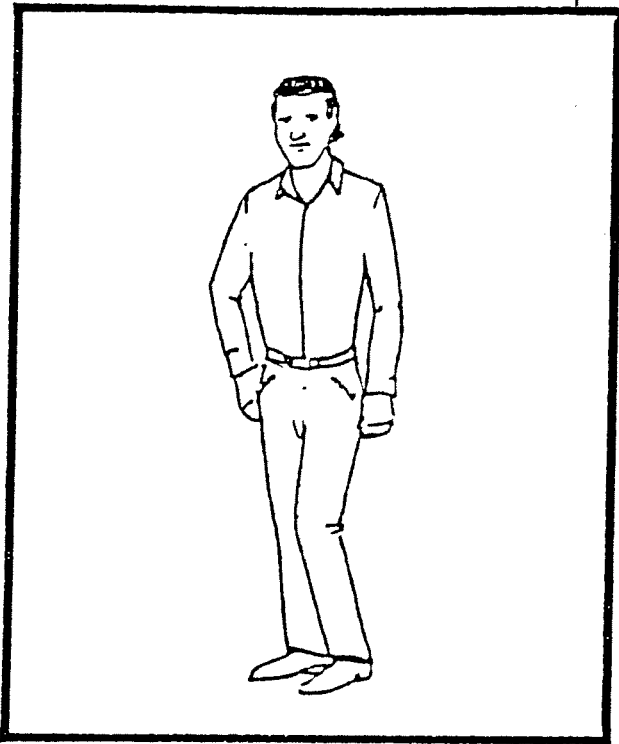

2

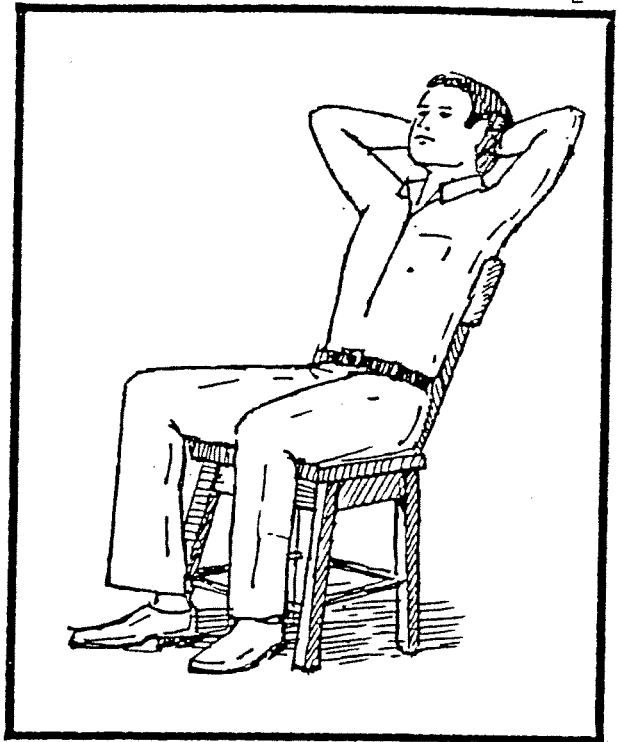

3

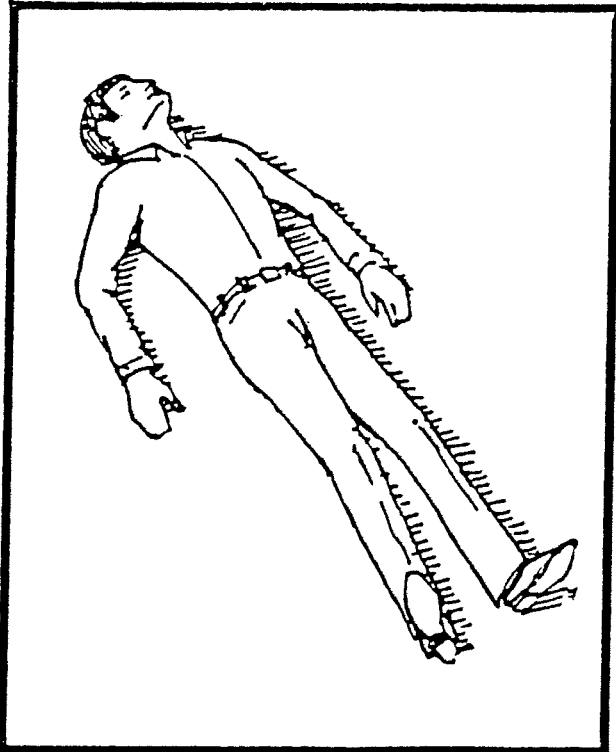

4



1

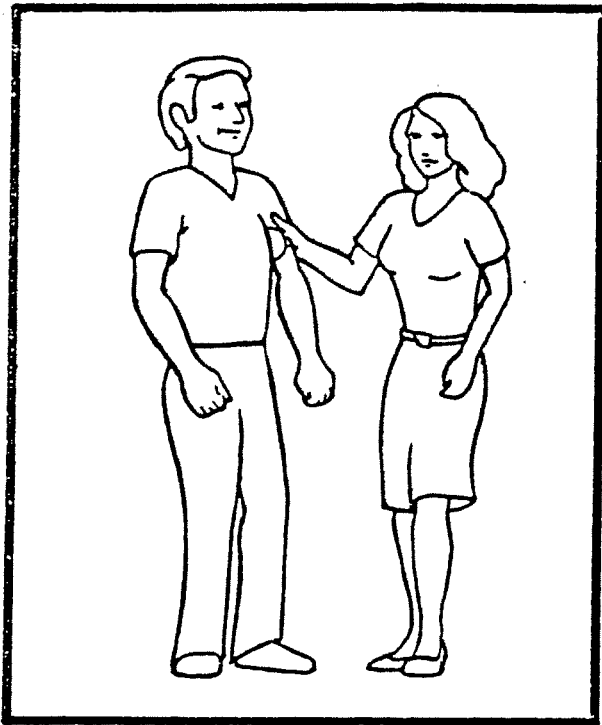

2

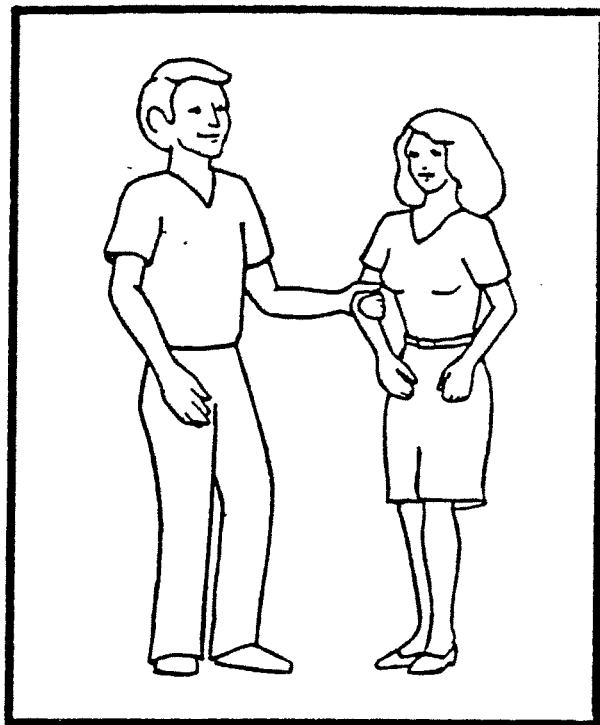

3

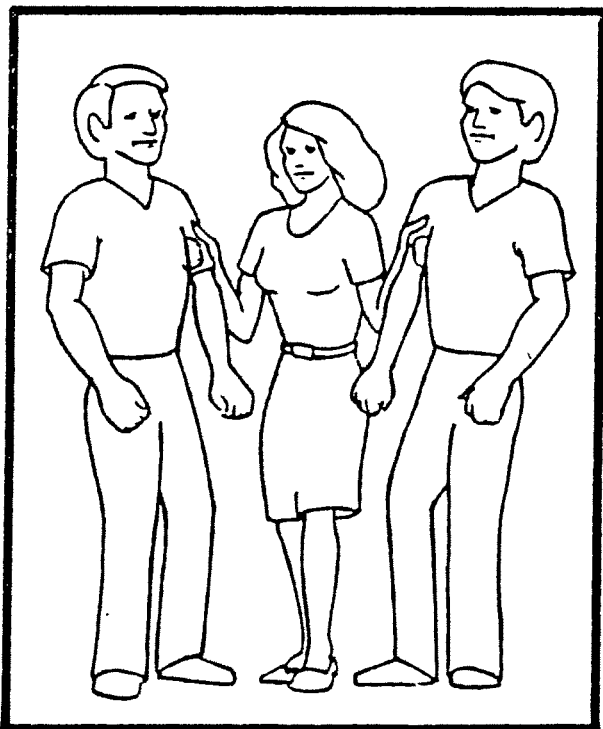

4

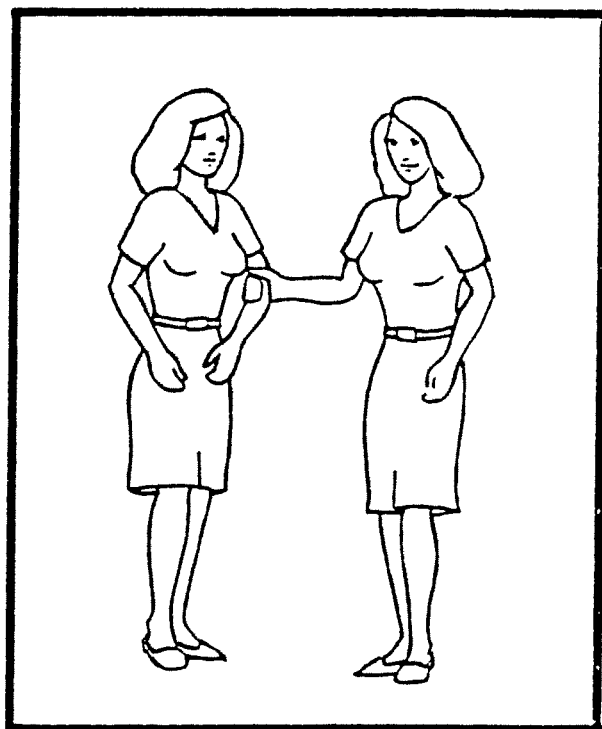

1

1



2

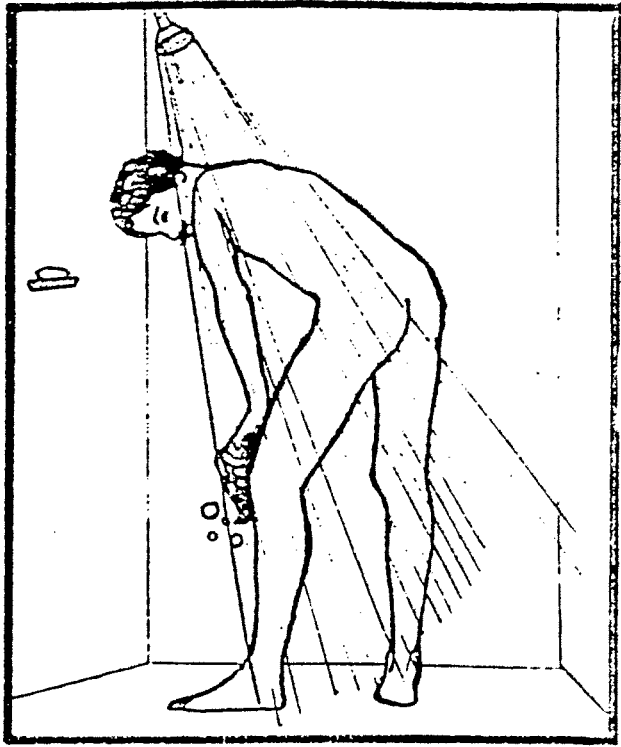

3

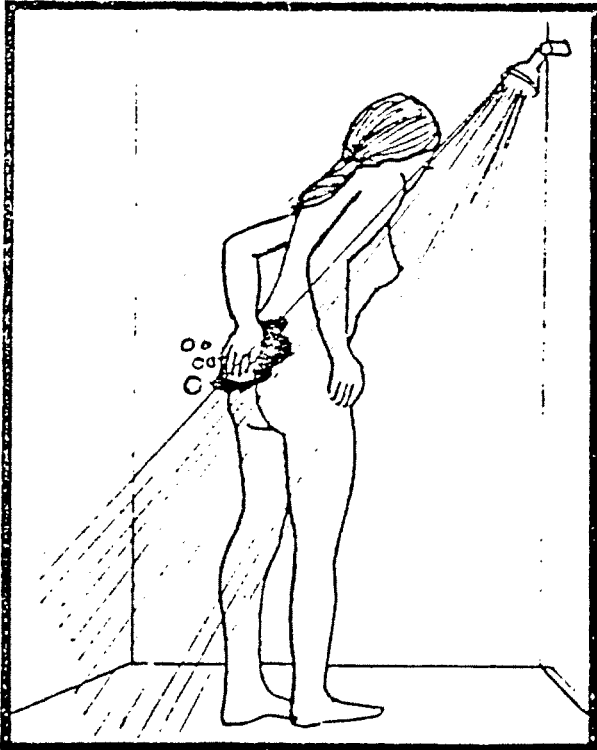

4



2

1

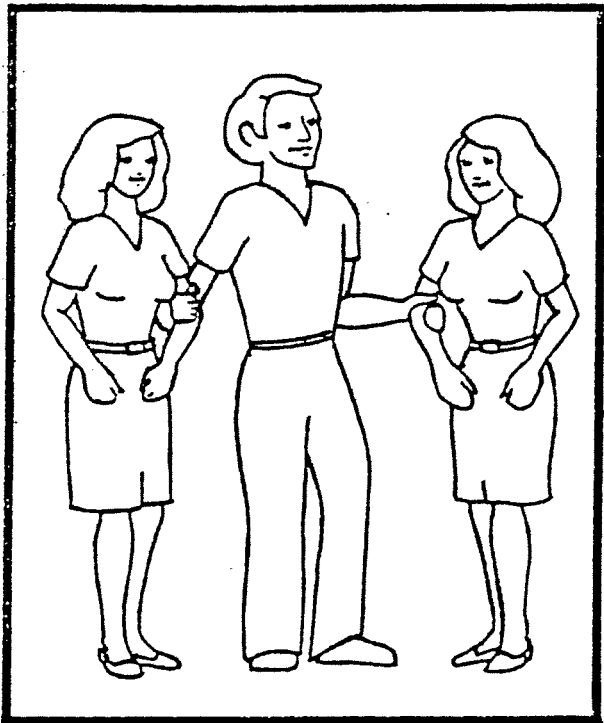

2

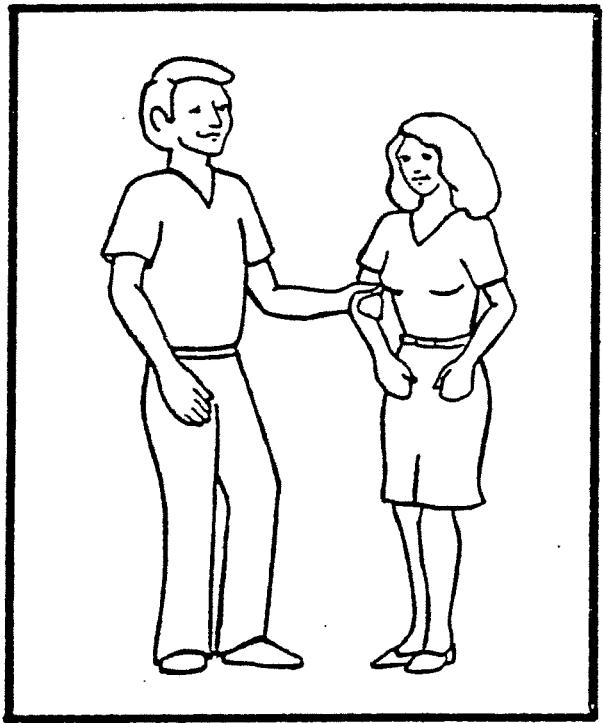

3

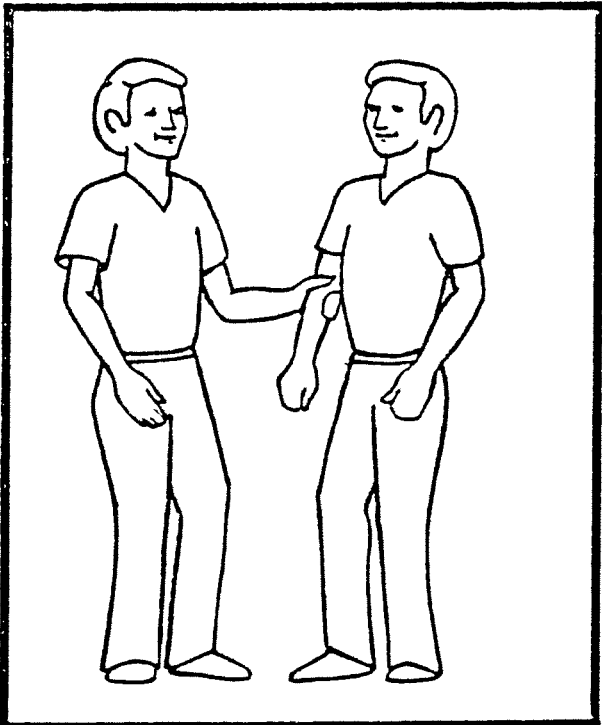

4

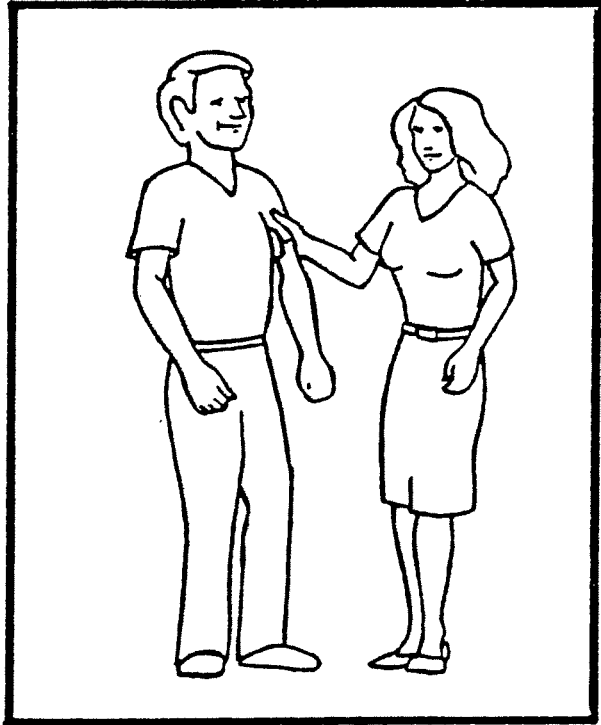

3

1

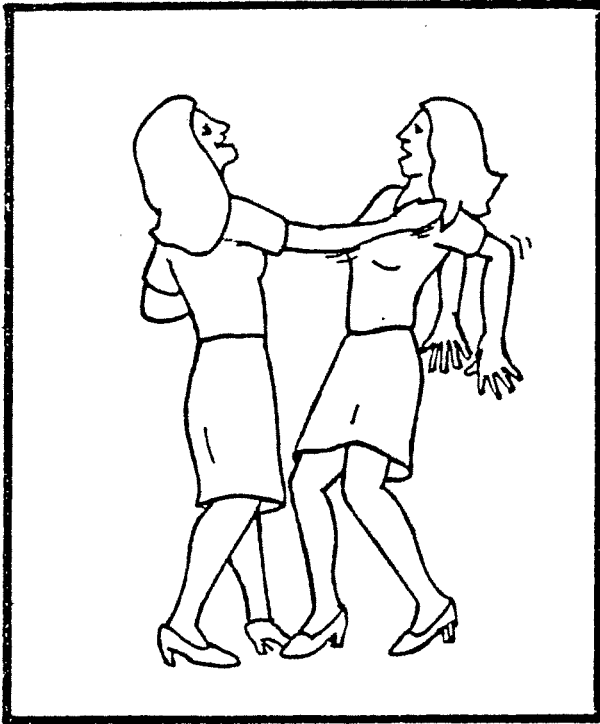

2

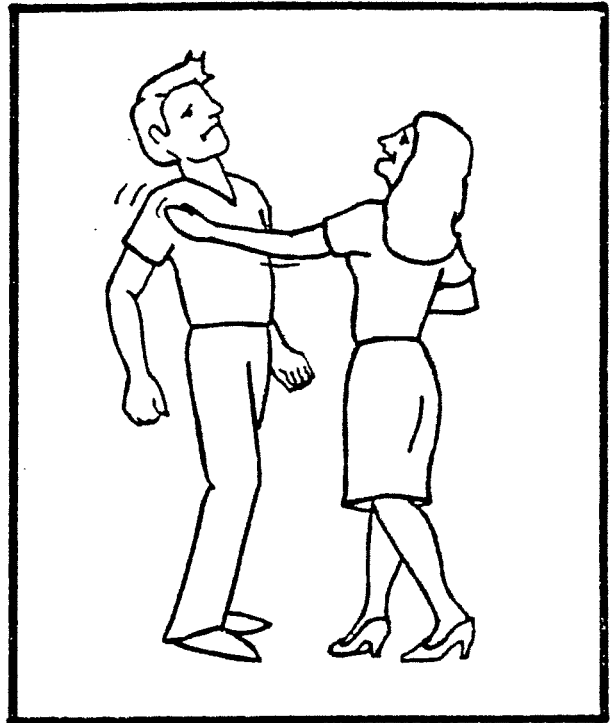

3

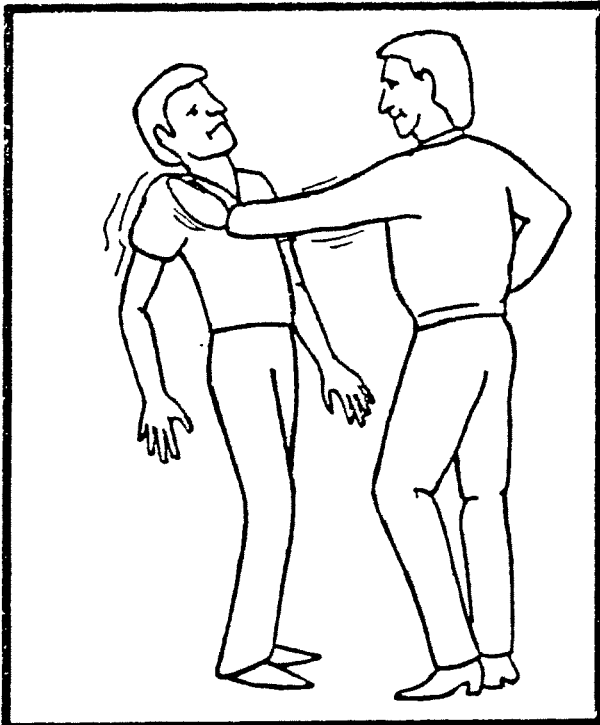

4

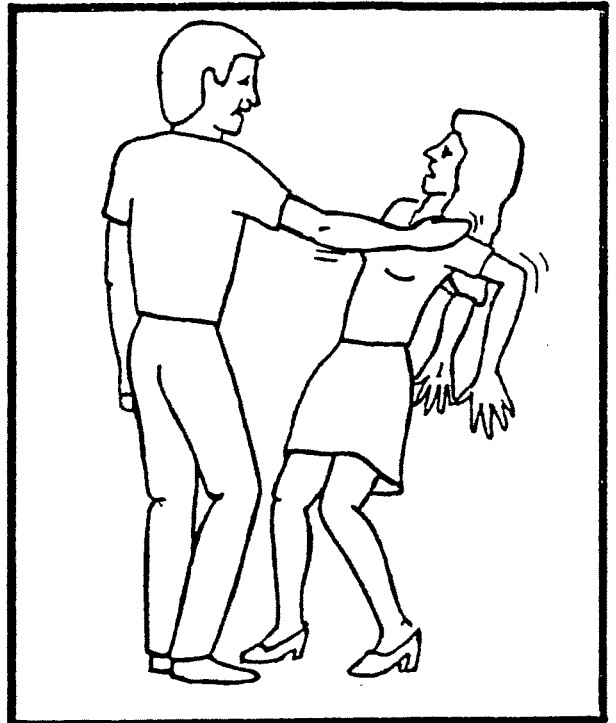

4

1

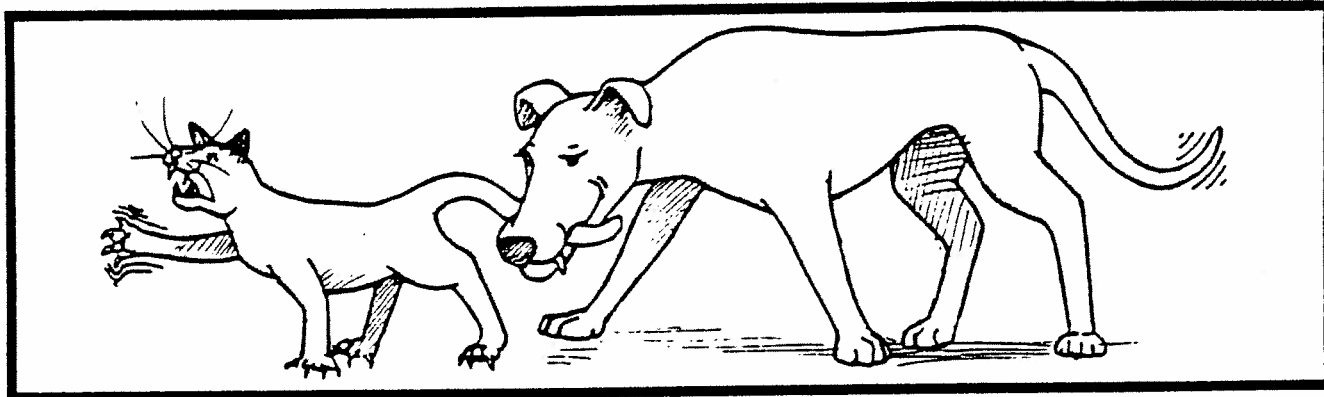

2

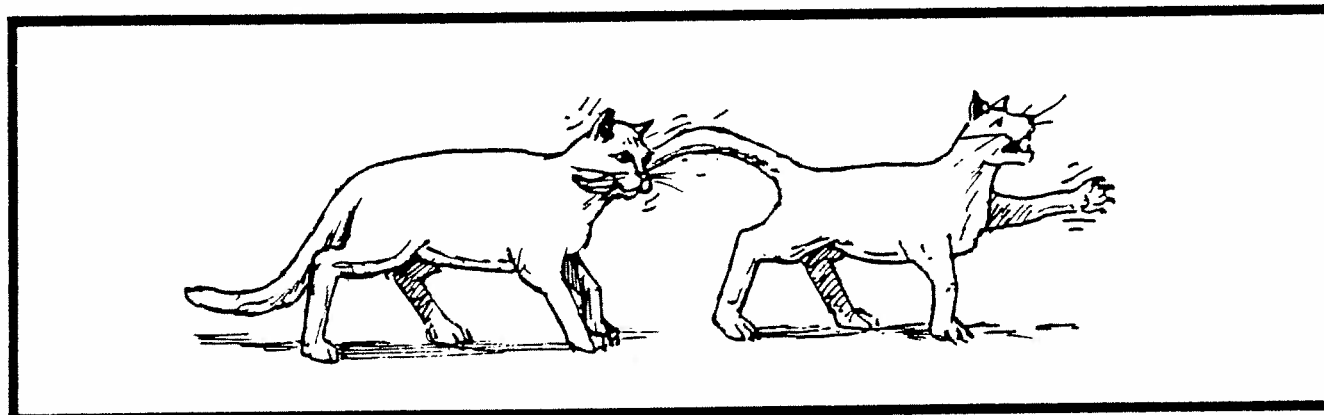

3

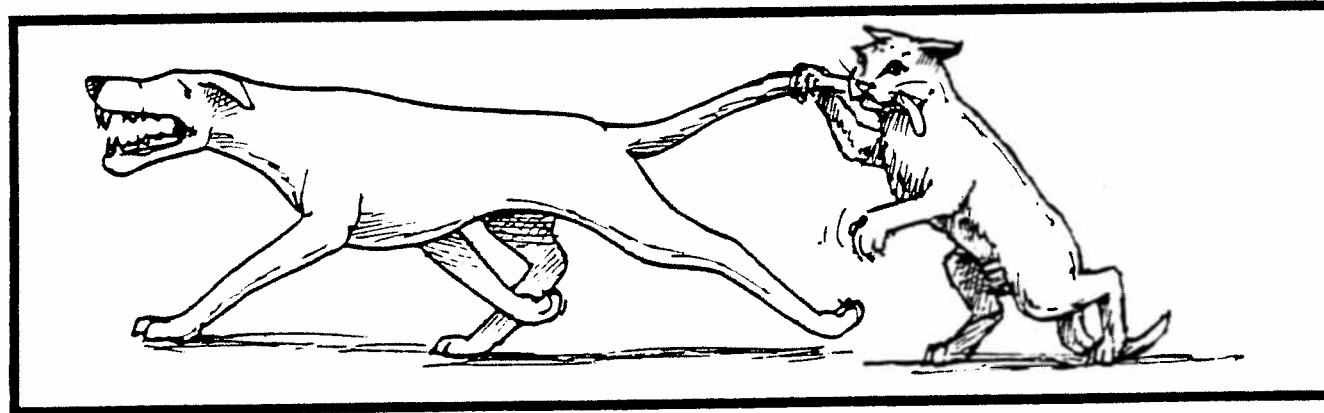

4

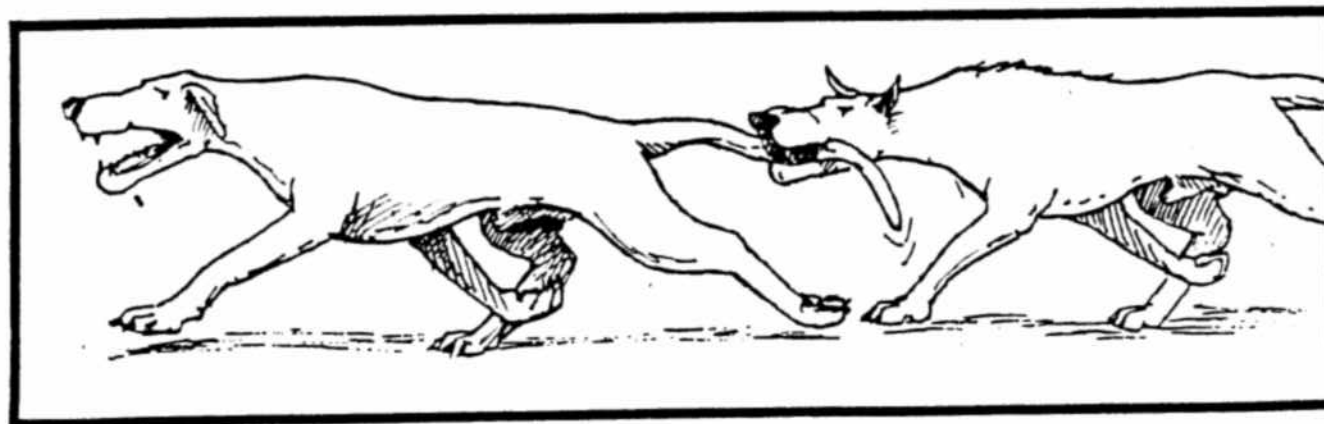

1

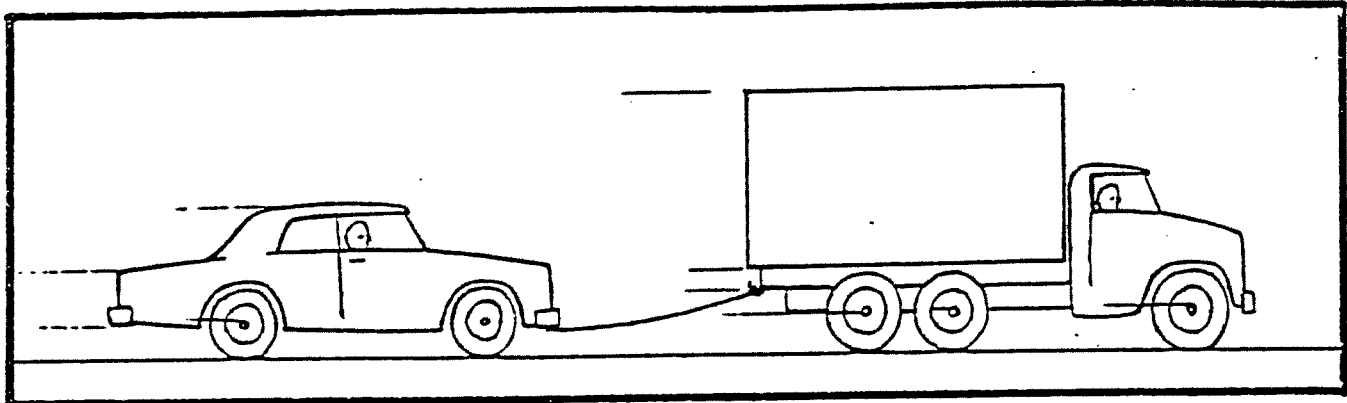

2

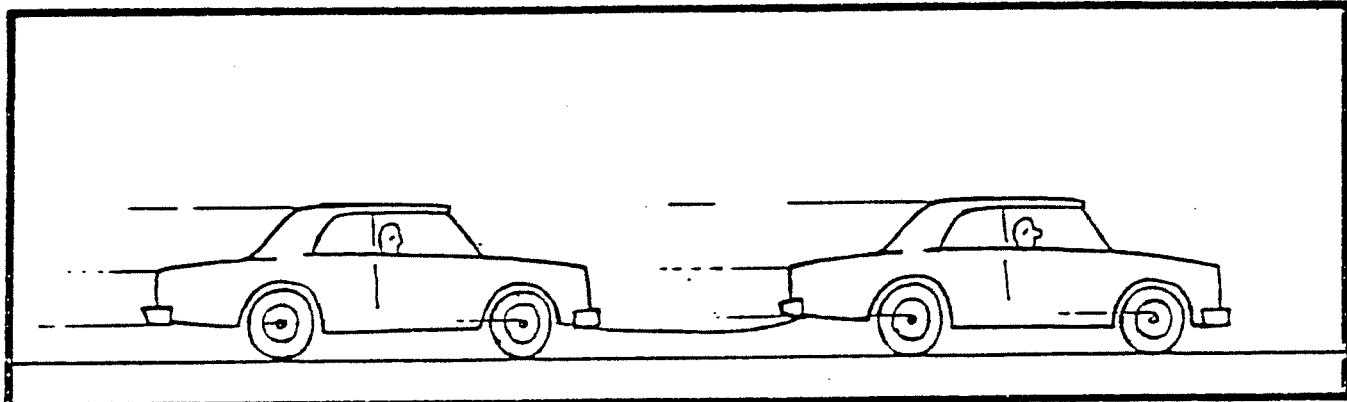

3

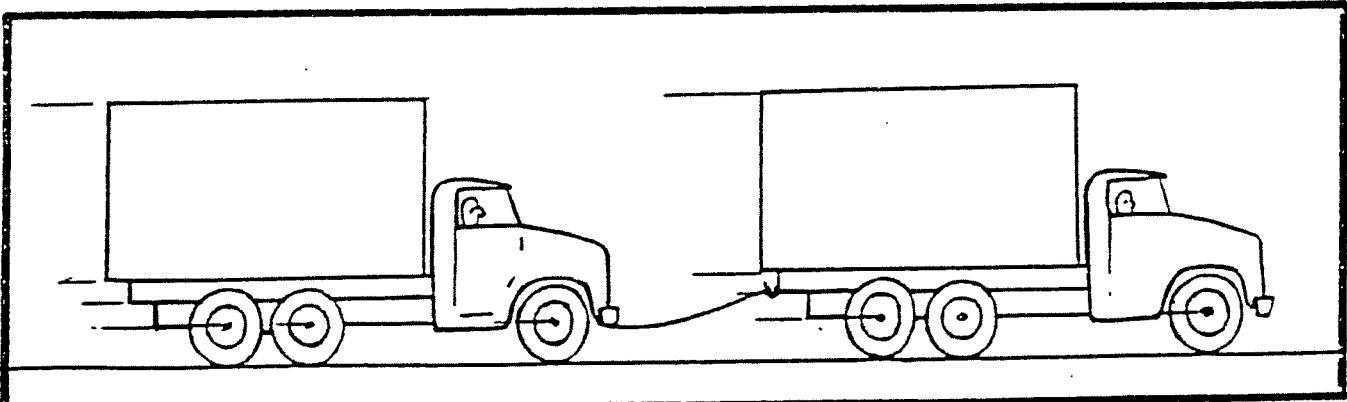

4

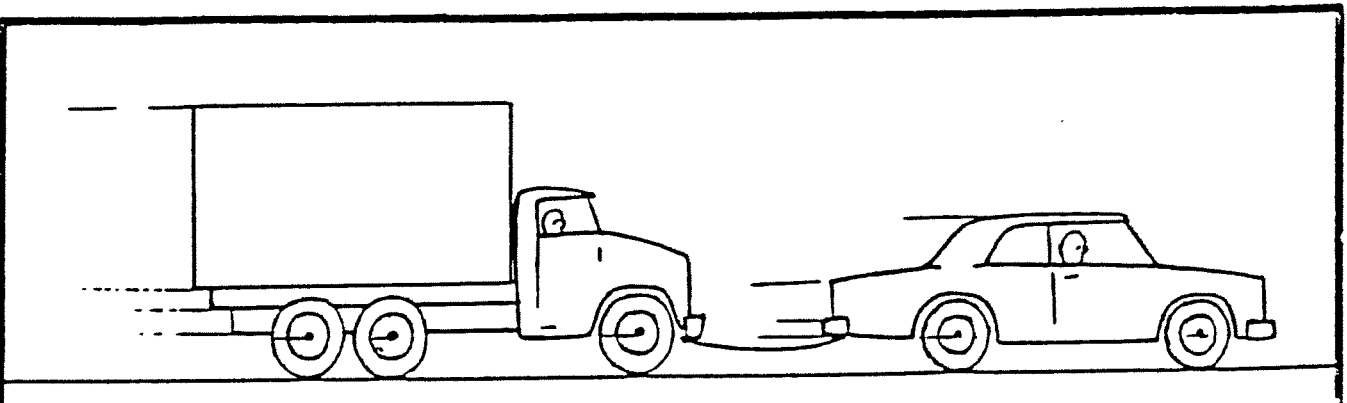

1

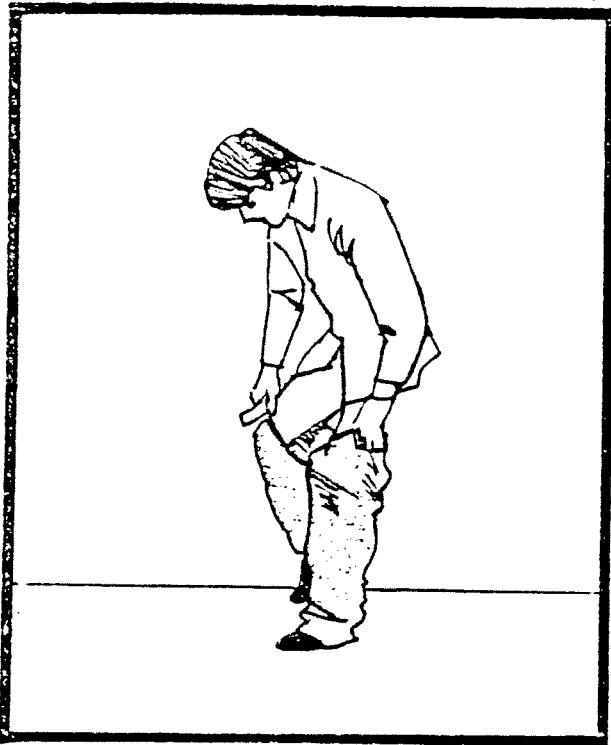

2

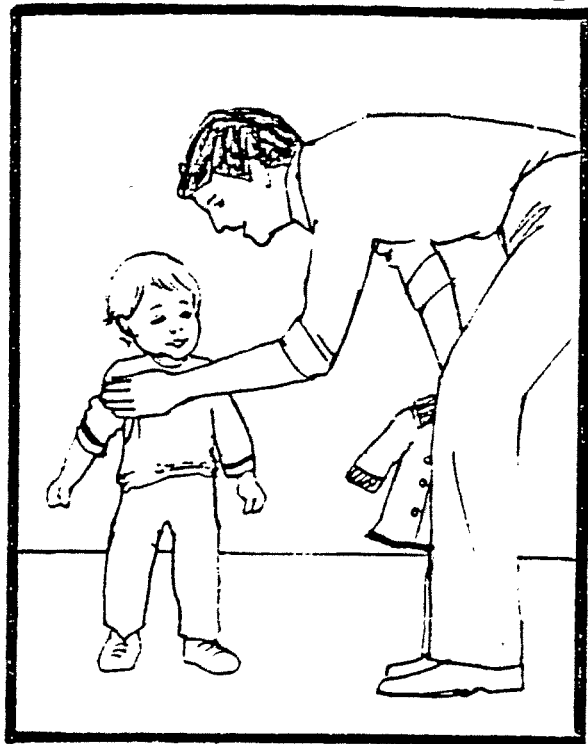

3

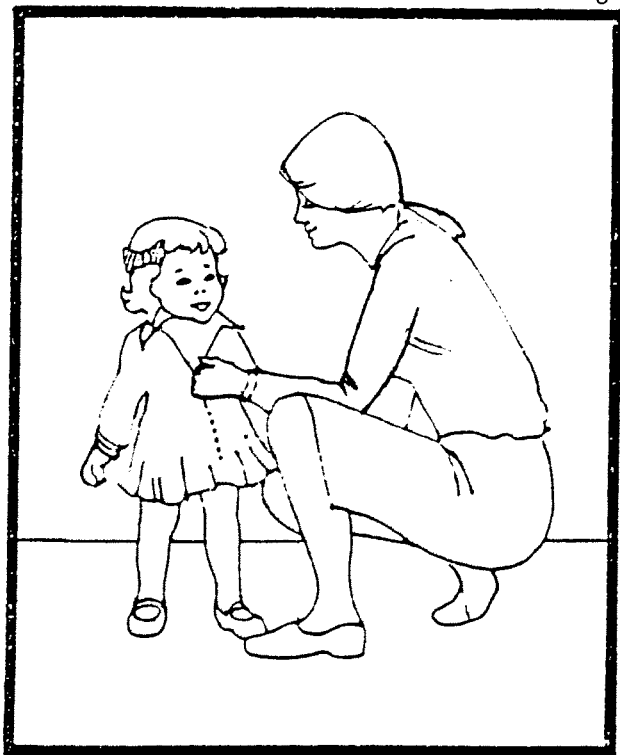

4



7

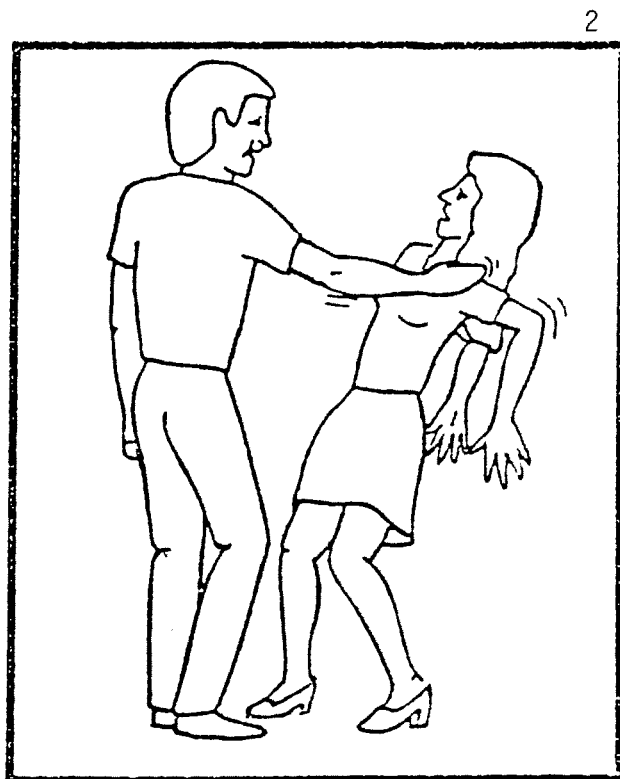
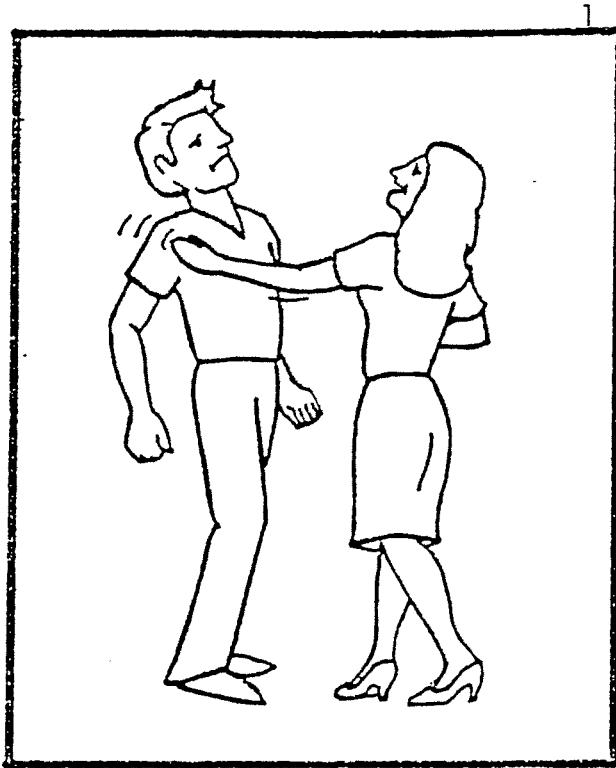

1

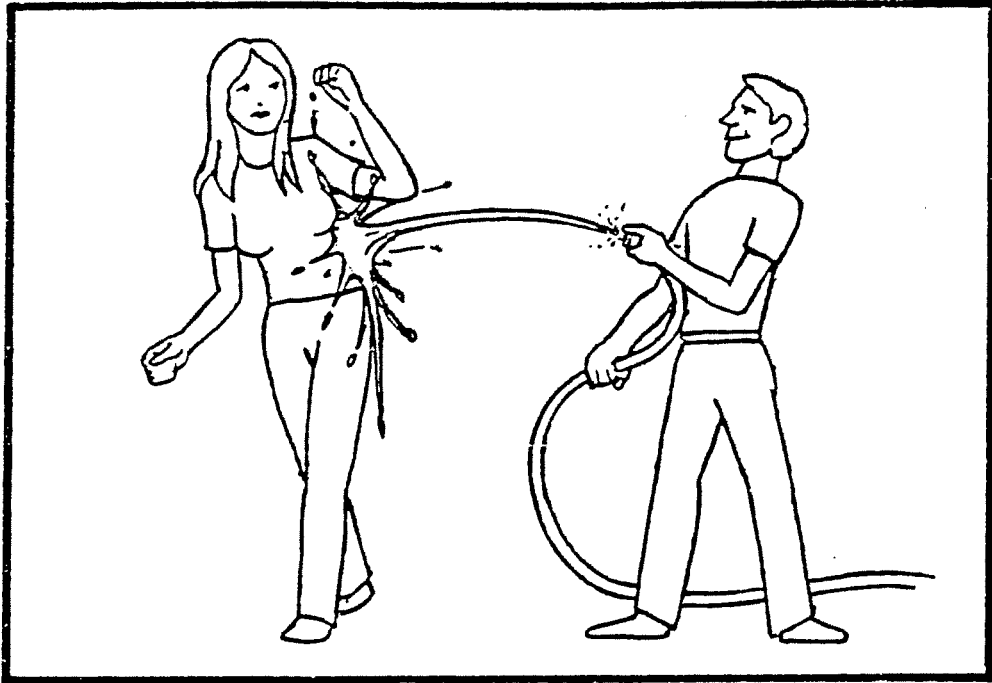

2

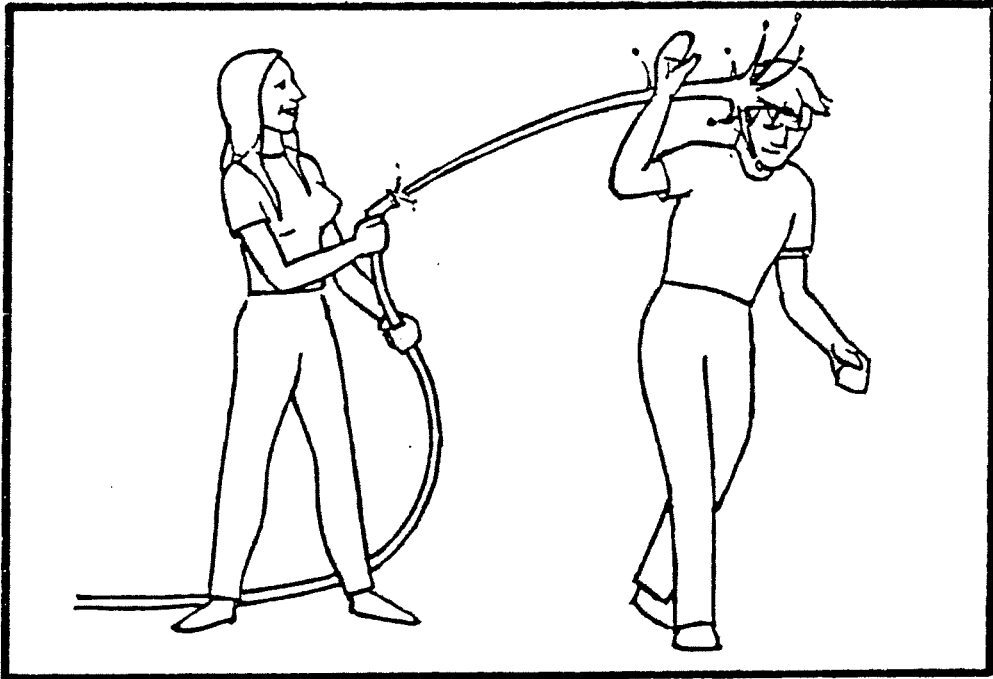

9

1

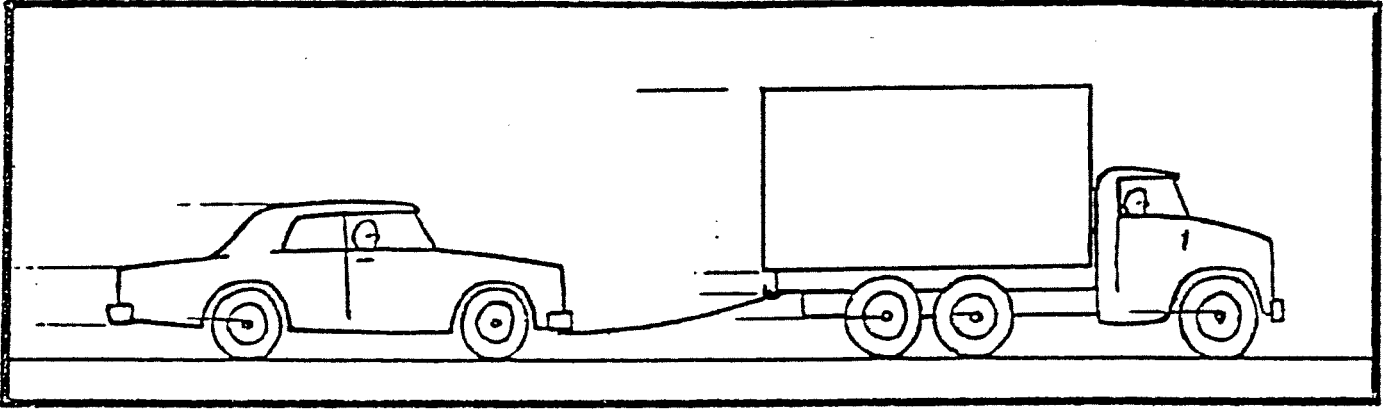

2

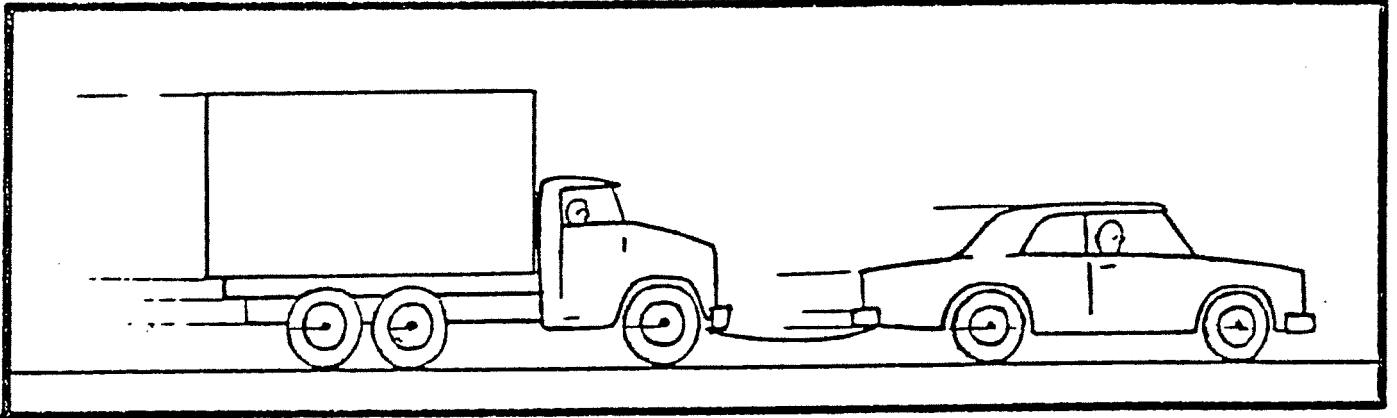

10

1



2



1

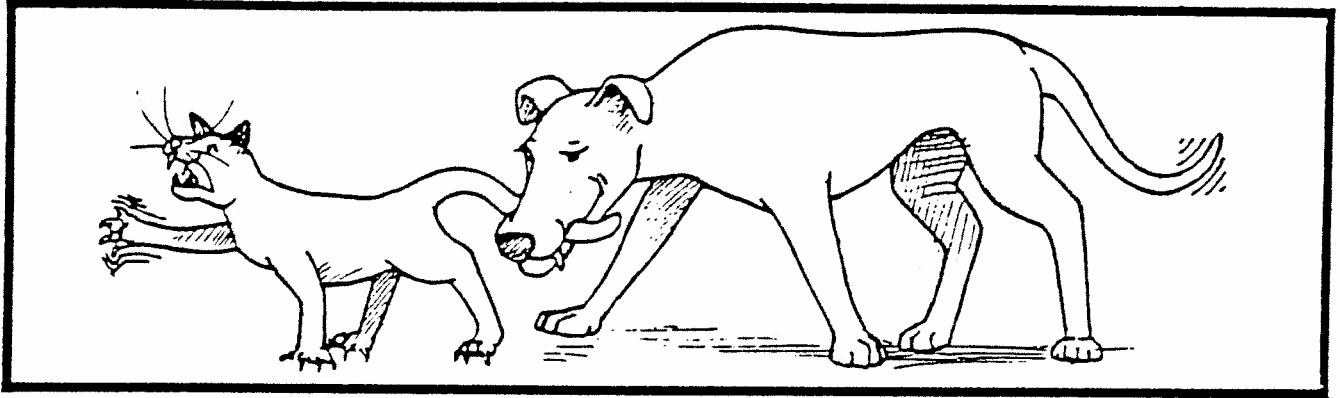

2

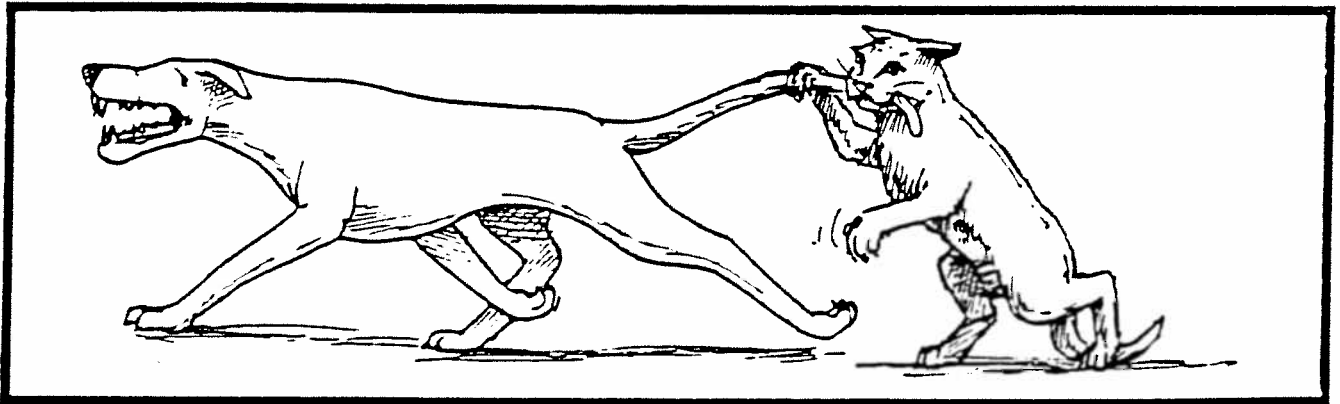

12

1



2



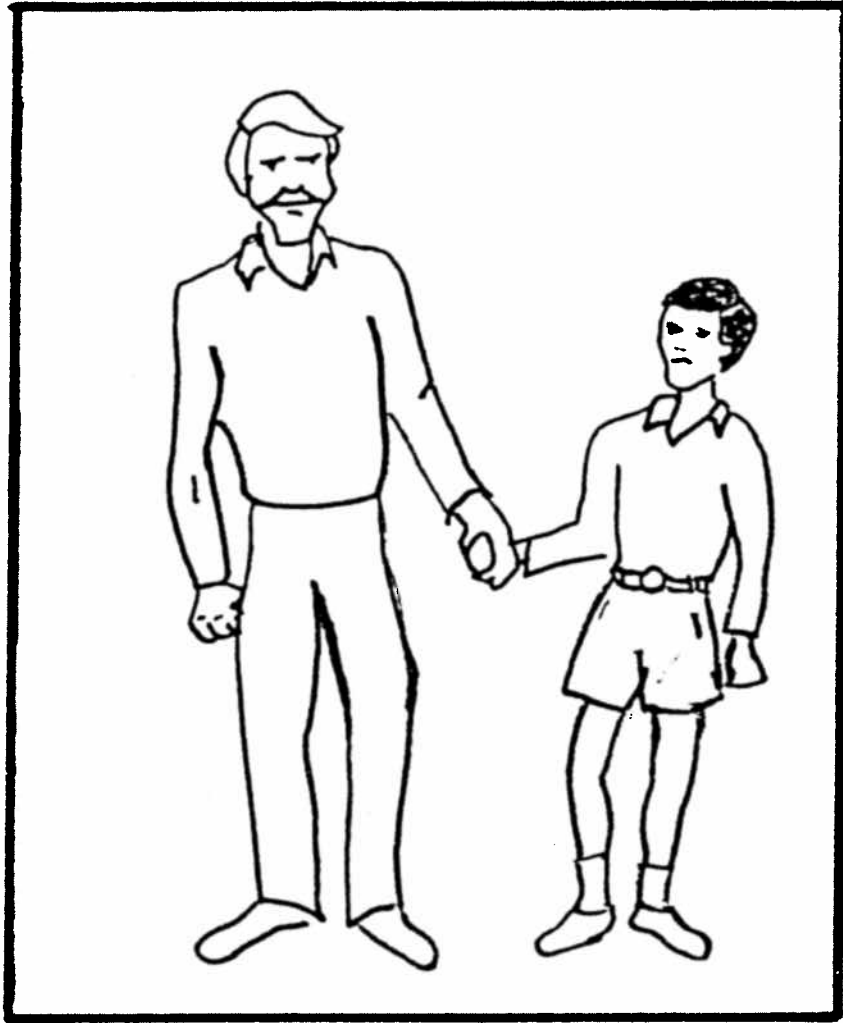

1

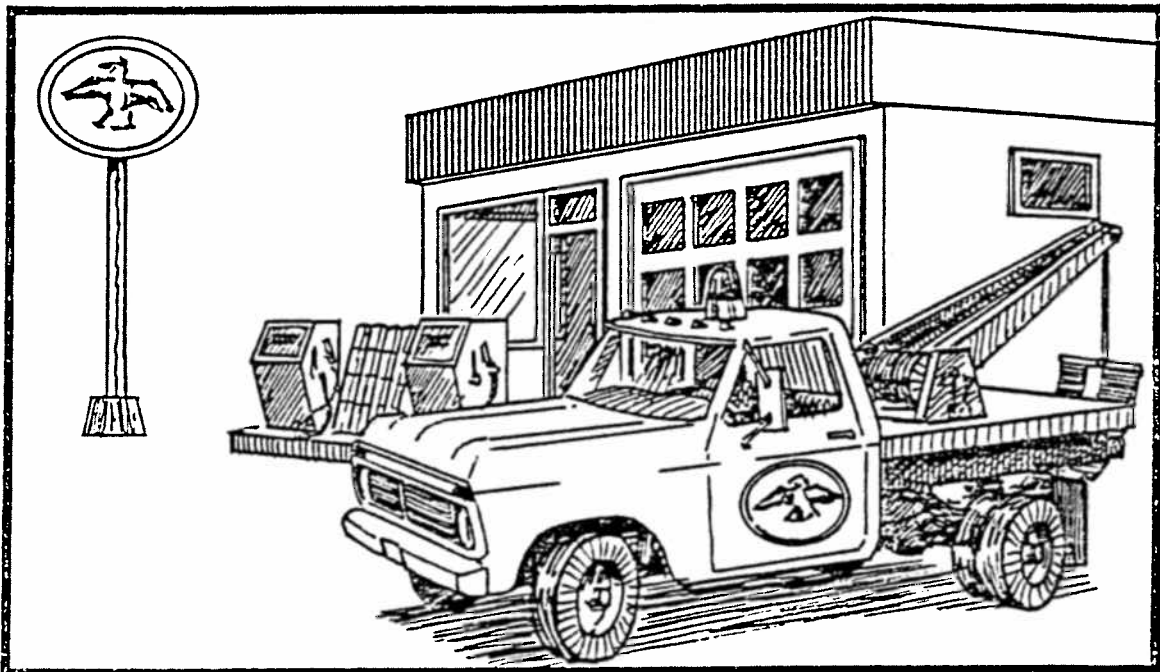

2

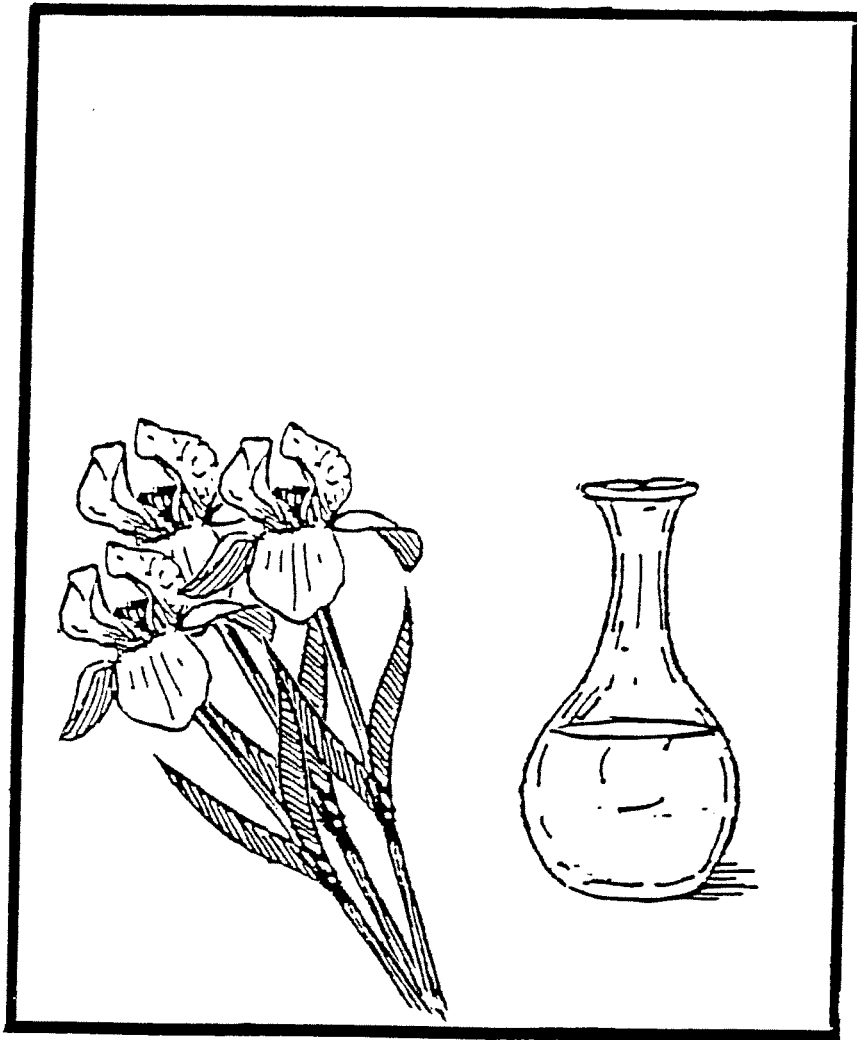



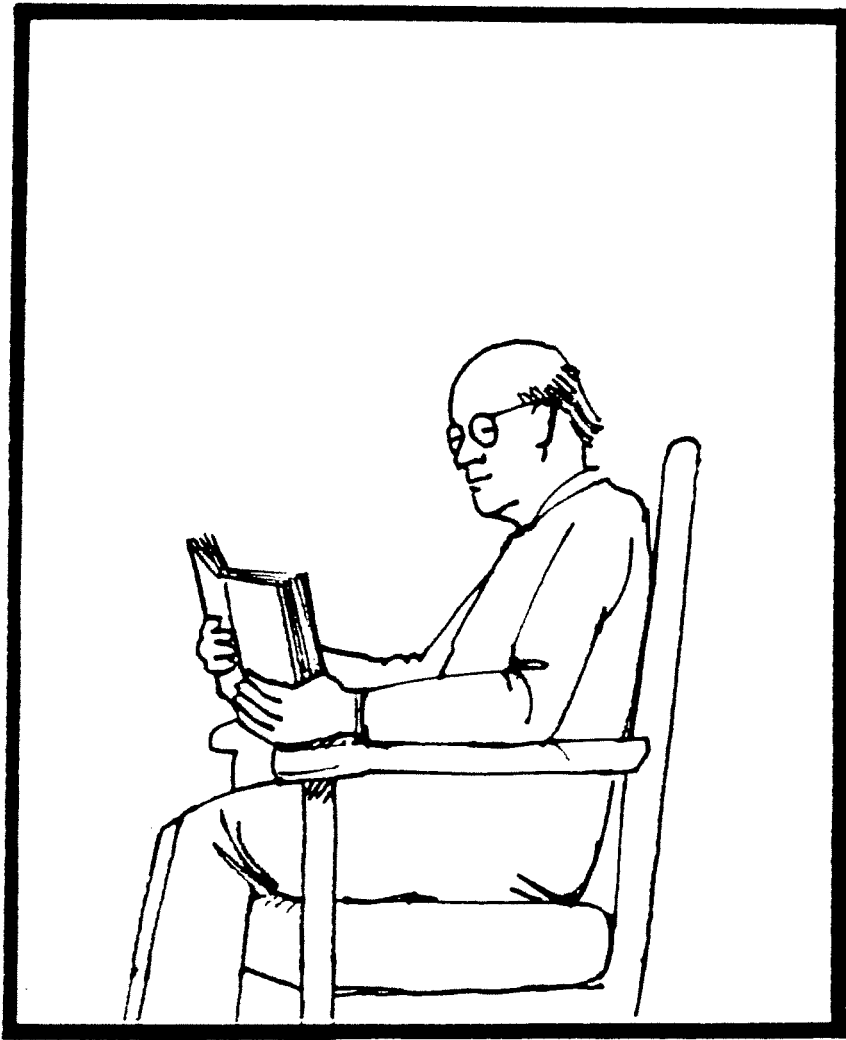

1

2

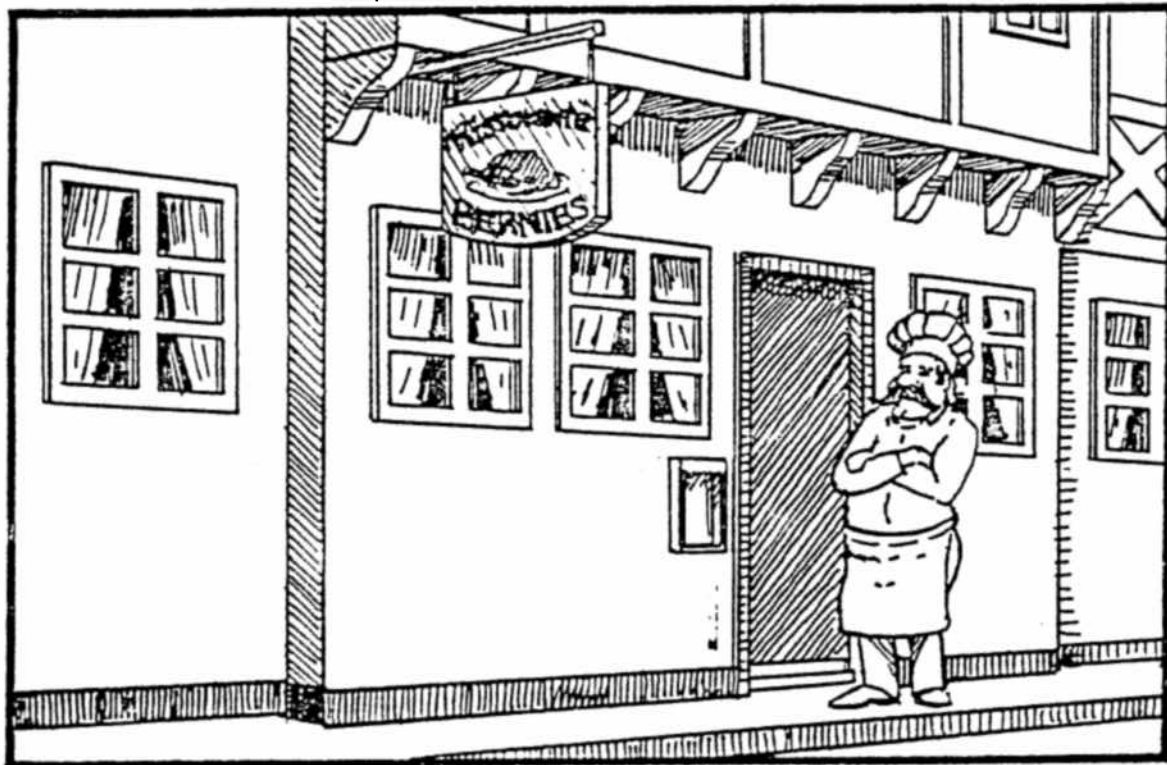

2

1



2

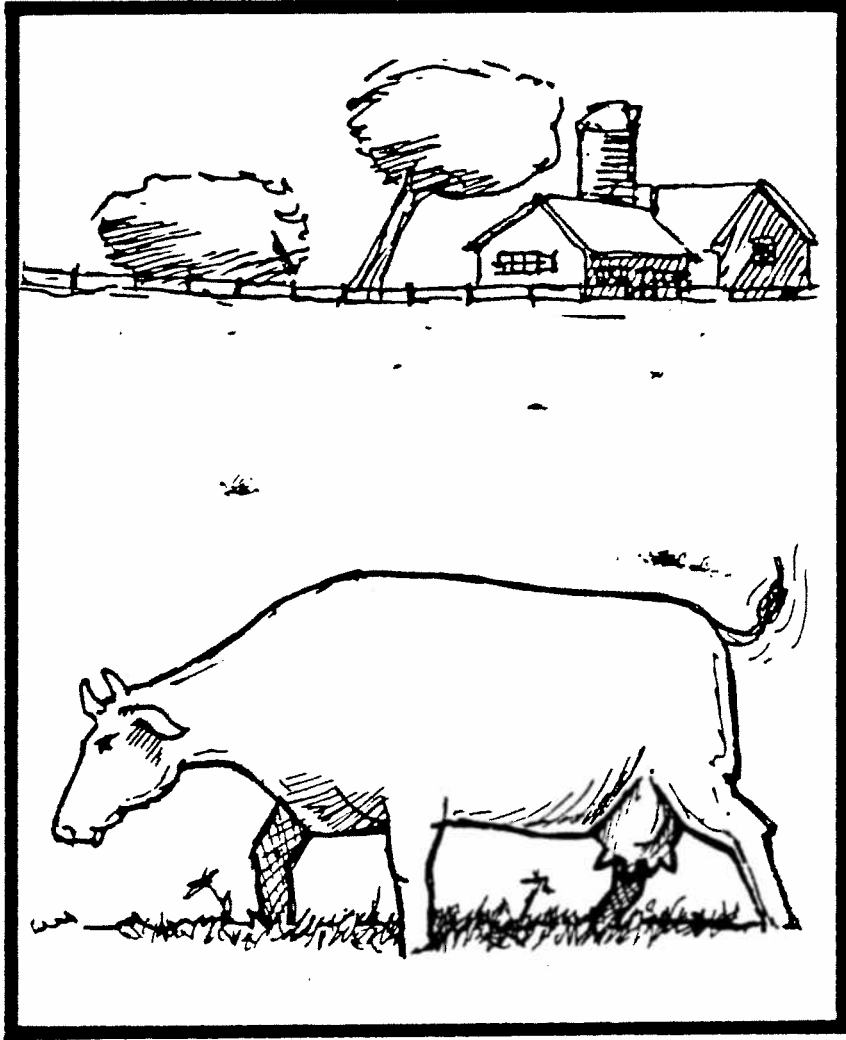

1

2

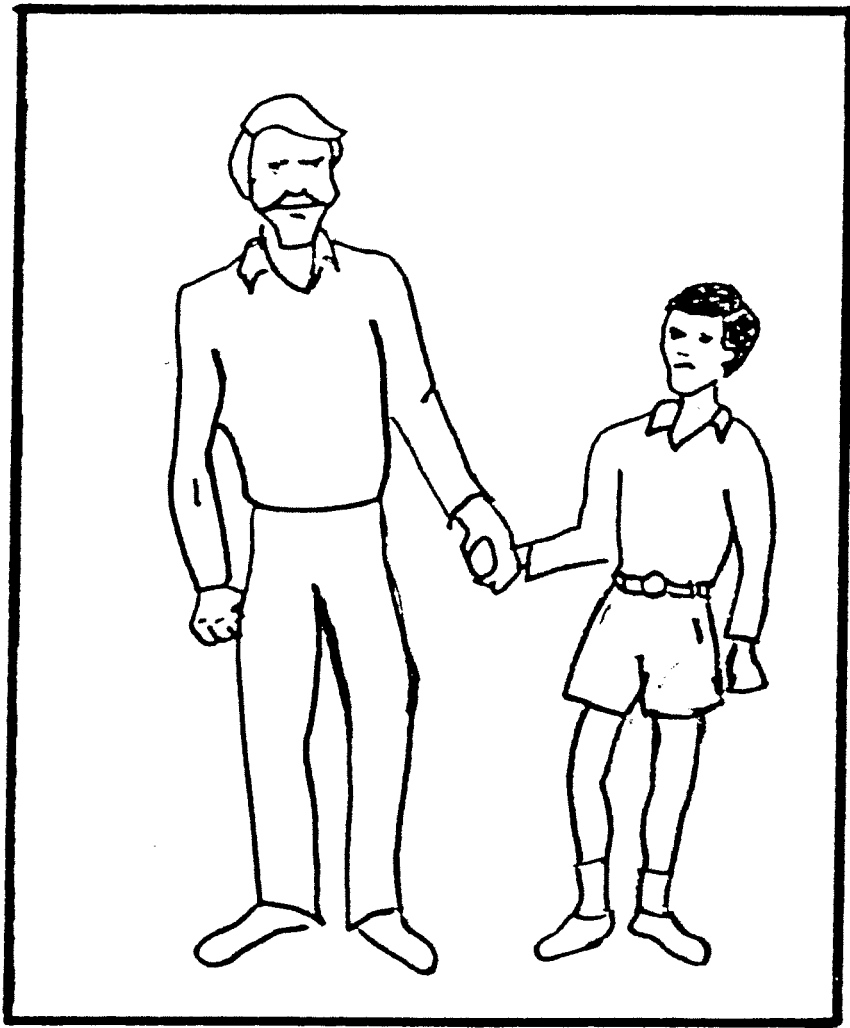

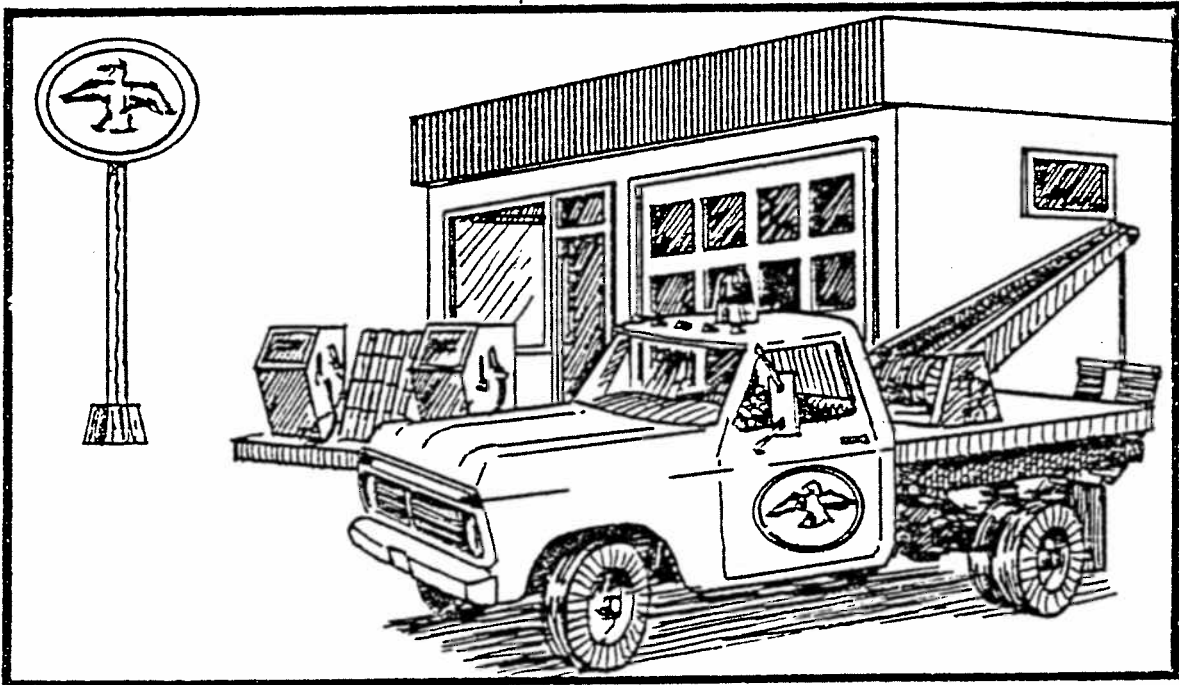

2

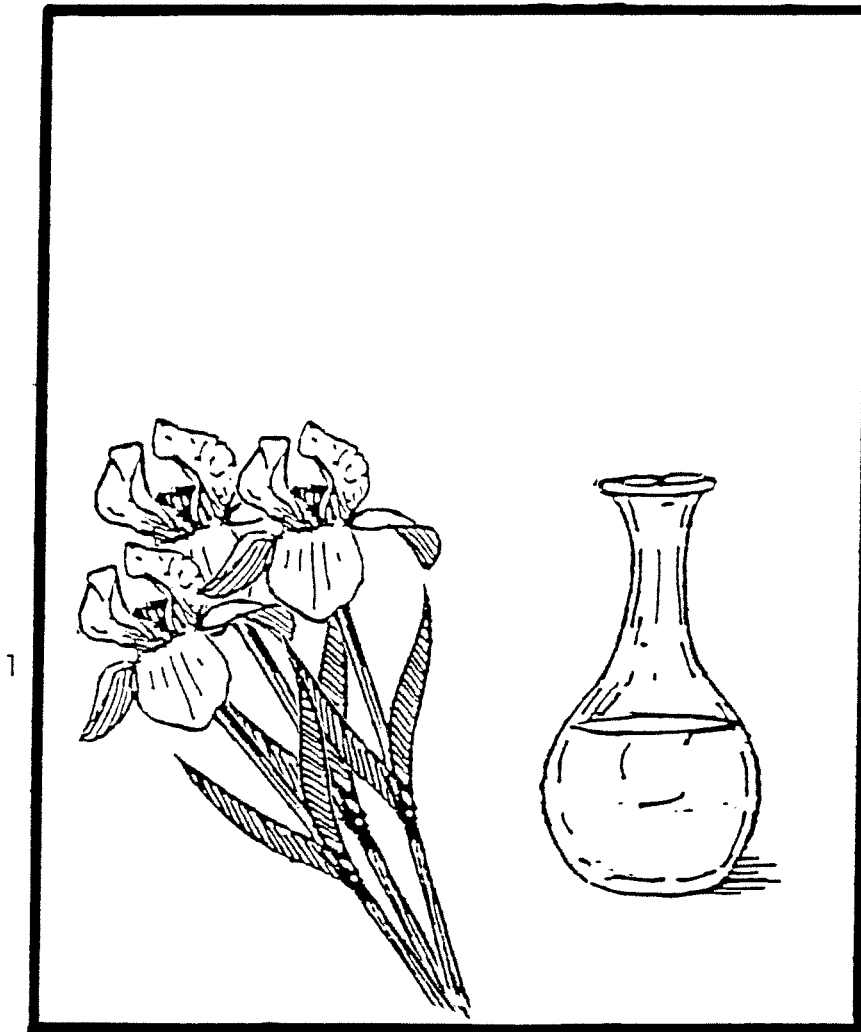



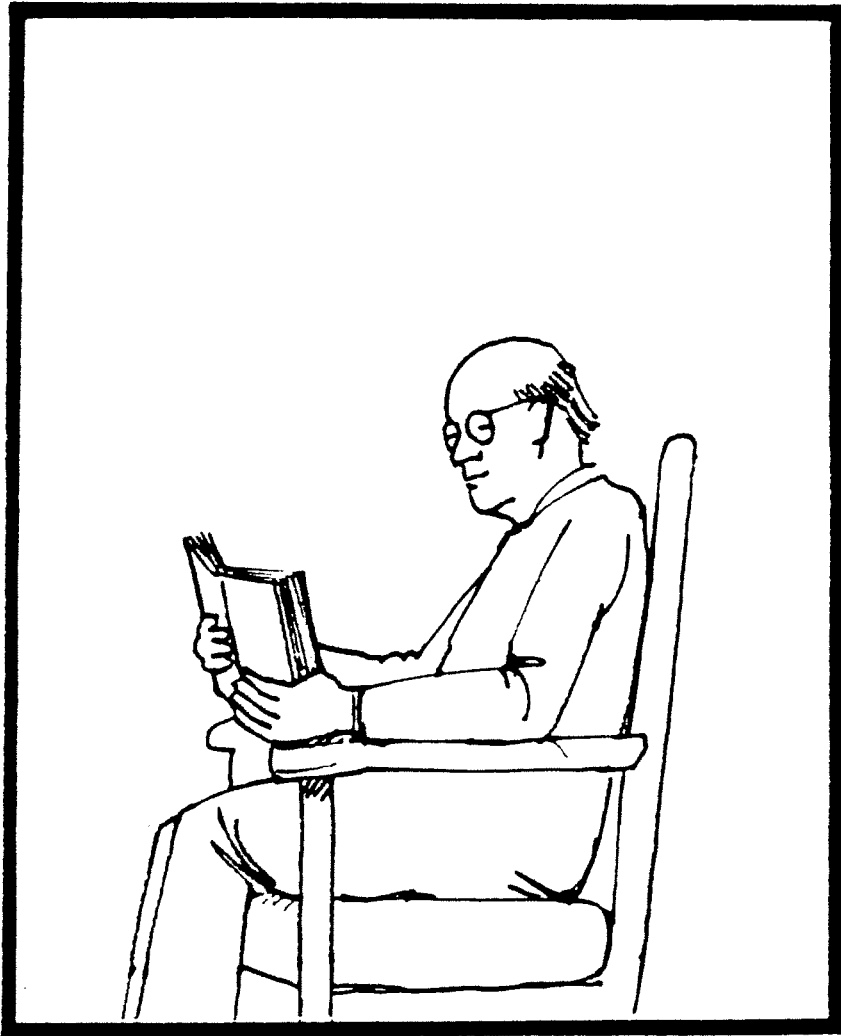

1

2

1

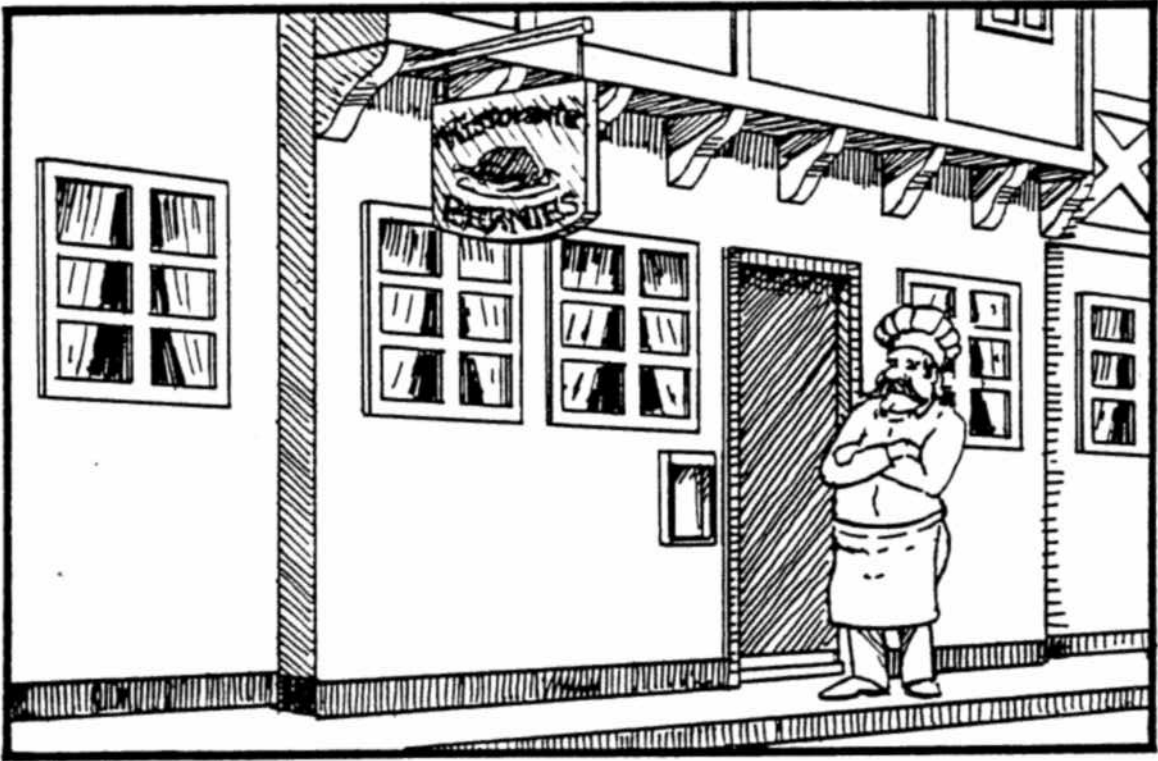

2

1



2

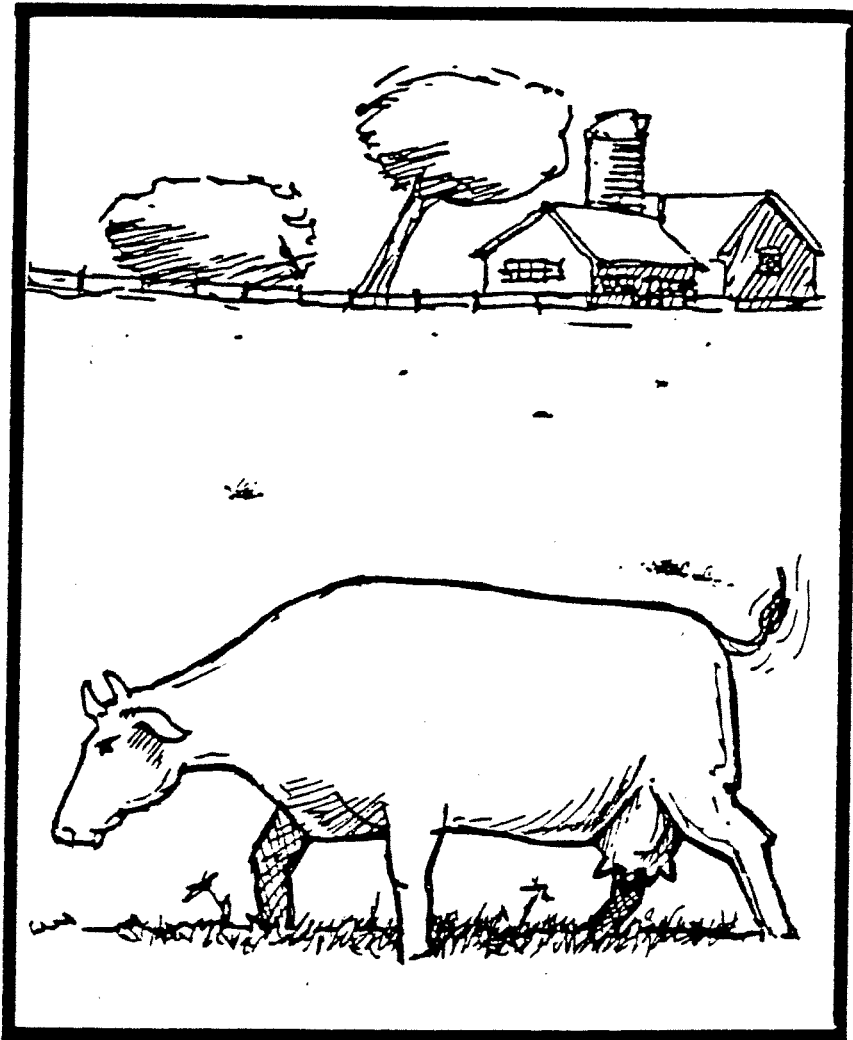

1

2

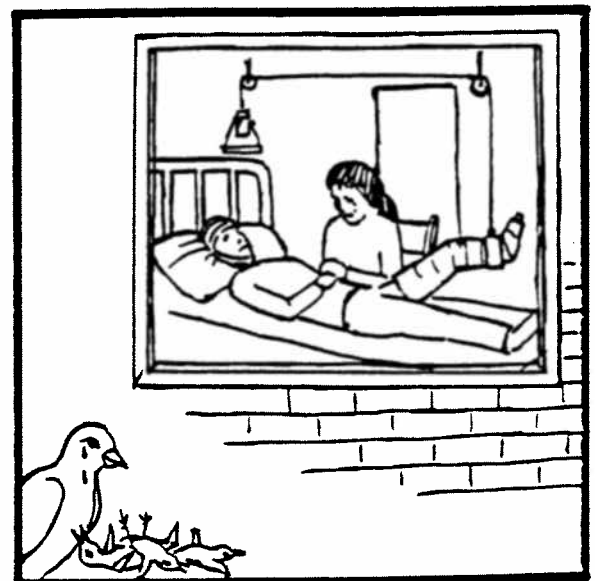
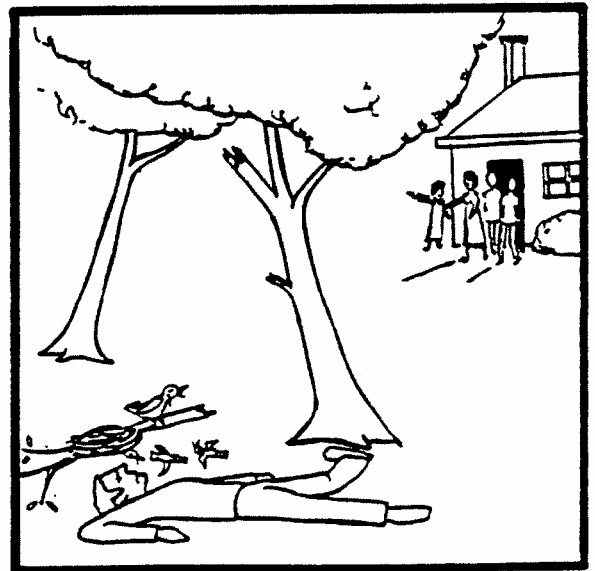
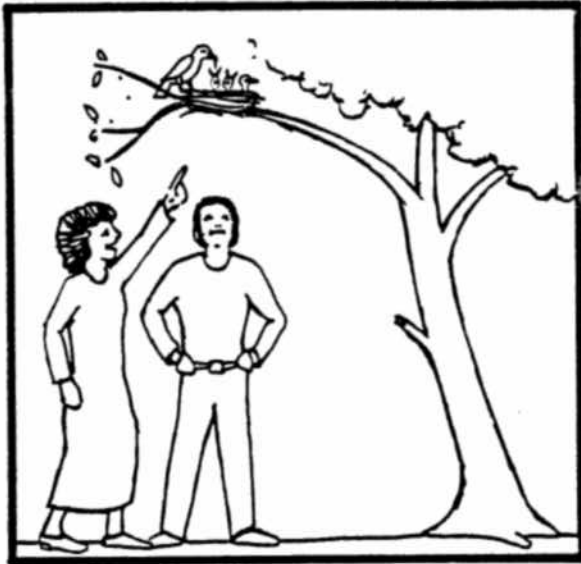

СОС

САК

СЛОН

КОСА

ГАЙКА

ЛОСТ

ДУК

ШАПКА

КРЪВ

КРАК

КАМИОНЪТ НЕ Е ТЕГЛЕН ОТ КОЛАТА.

КУЧЕТО Е, КОЕТО КОТКАТА ХАПЕ.

ТОЙ Я ДЪРЖИ.

МОМИЧЕТО Е БЛЪСНАТО ОТ МОМЧЕТО.

МОМЧЕТО ДЪРЖИ МОМИЧЕТО.

МОМИЧЕТО НЕ Е ЦЕЛУВАНО ОТ МОМЧЕТО.

ТОЙ СЕ КЪПЕ .

КУЧЕТО Е УХАПАНО ОТ КОТКАТА .

КАМИОНЪТ Е, КОЙТО ТЕГЛИ КОЛАТА.

МОМЧЕТО НЕ БЛЪСКА МОМИЧЕТО.

Двама братя отидоха на лов в близката гора
Убиха три диви зайци. Когато се върнаха в селото,
отидоха на пазара и размениха зайците за тютюн.

БАНА

ЛАМА

ПЕРАЧКА

ЛАЙКА

ЧУК

РИСУНКИ

ЧЕТЕНЕ НА УМ (СХВАЩАНЕ НА СМИСЪЛА, ДУМИ)

COC

1

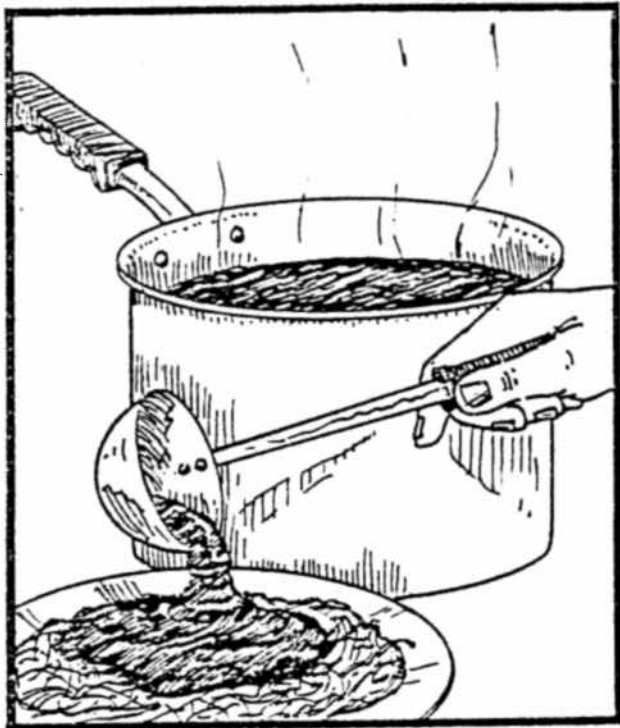

2

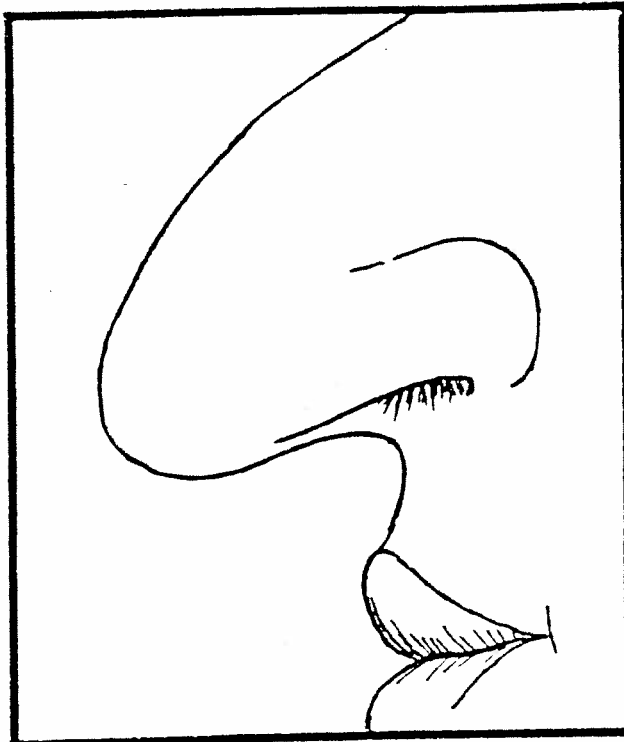

3

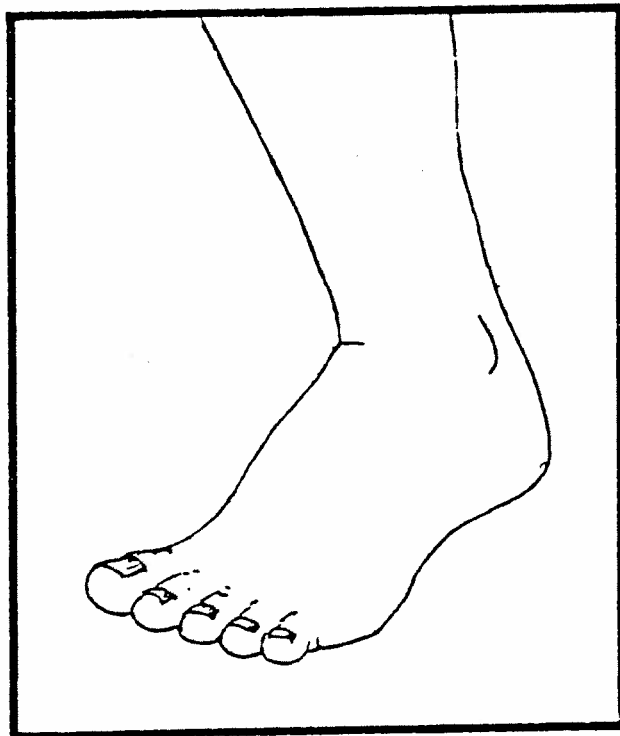

4

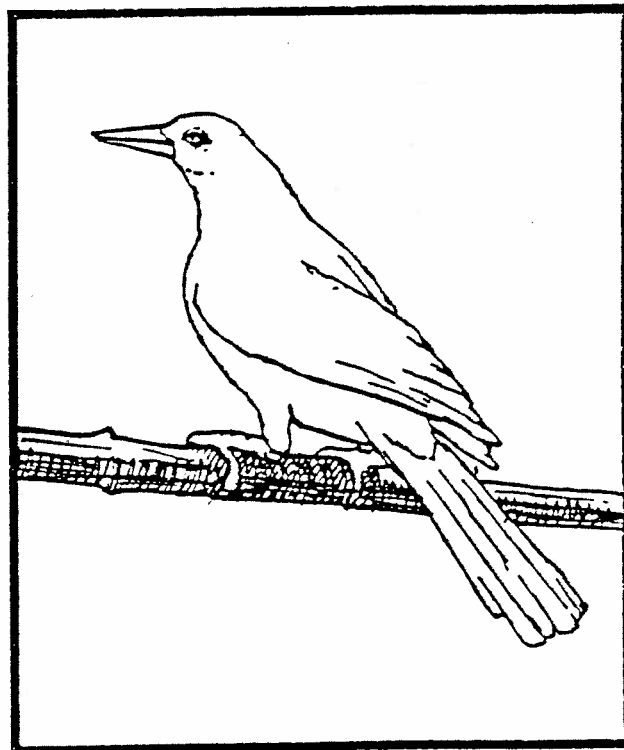

CAK

1

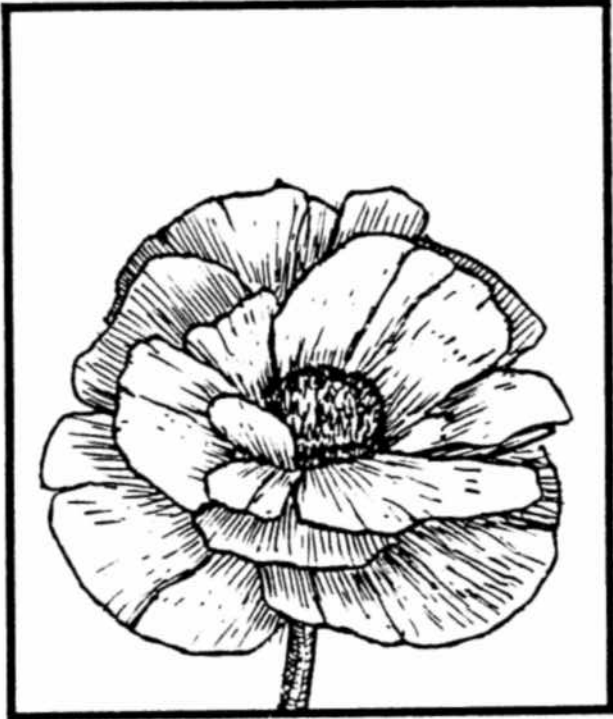

2

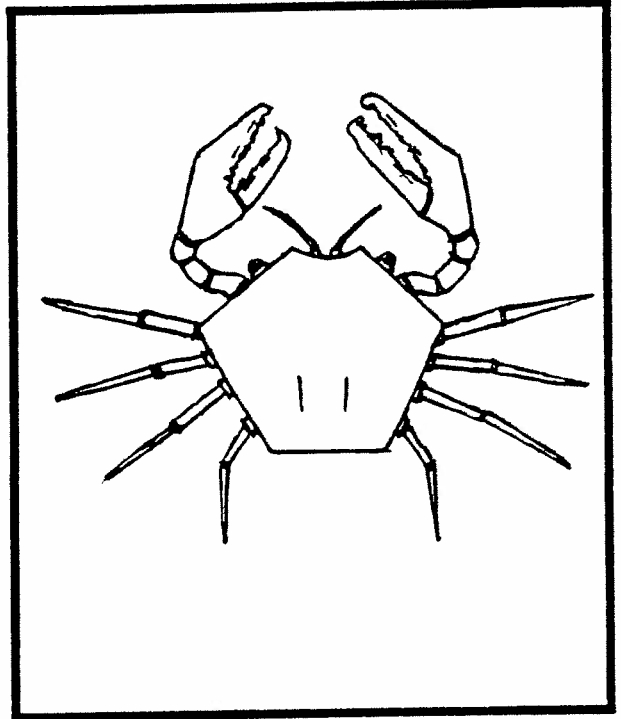

3



4

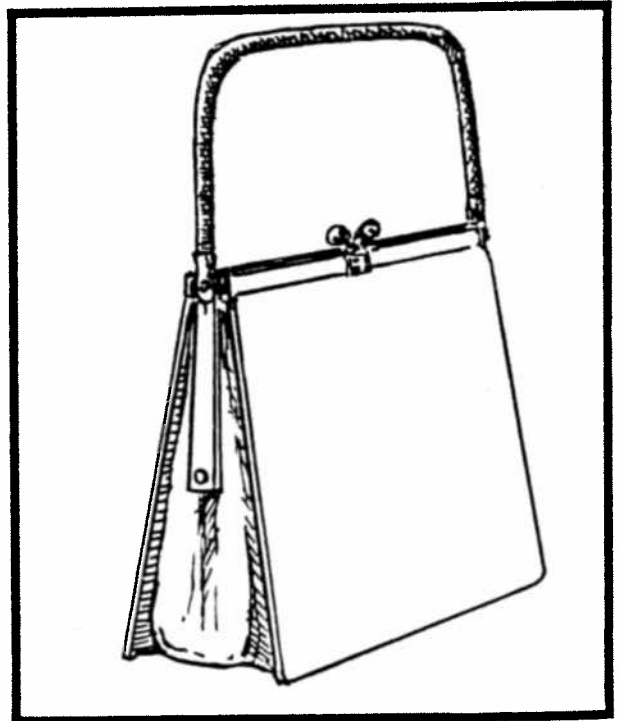

СЛОИ

1

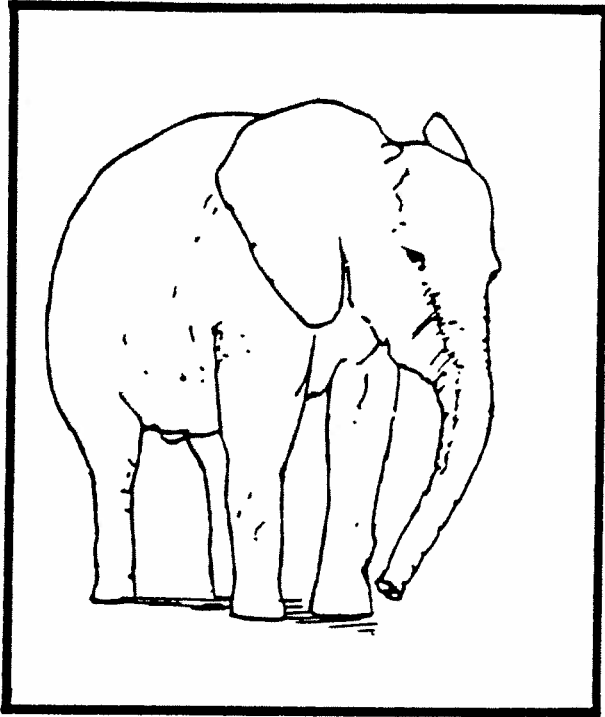

2

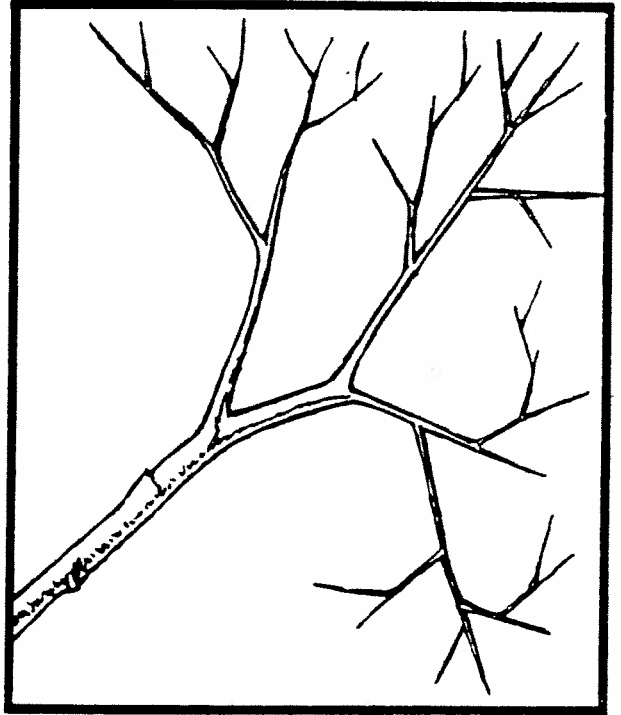

3

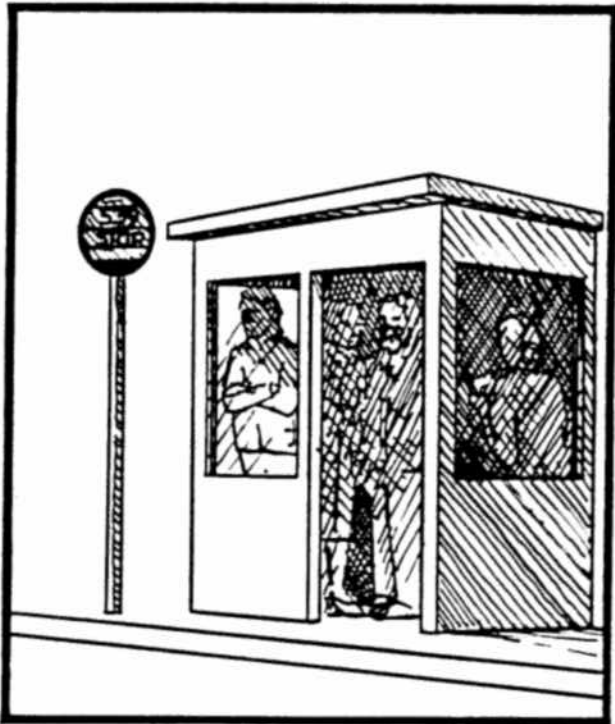

4



KOCA

1

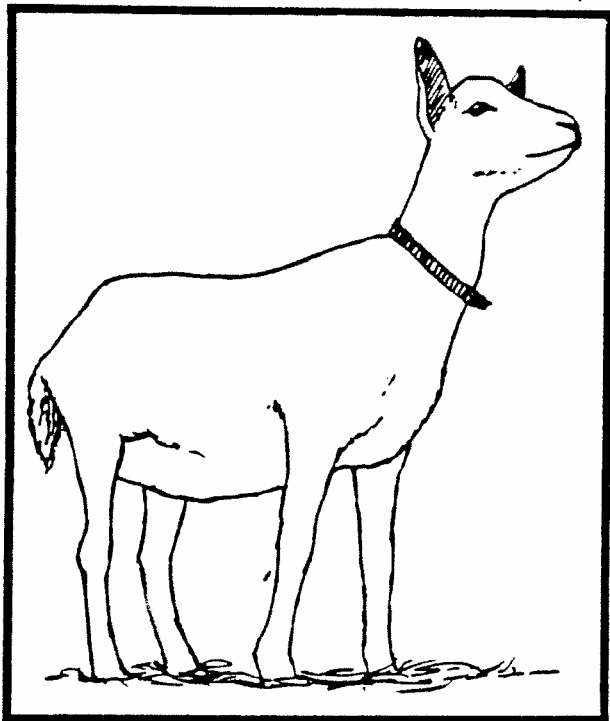

2

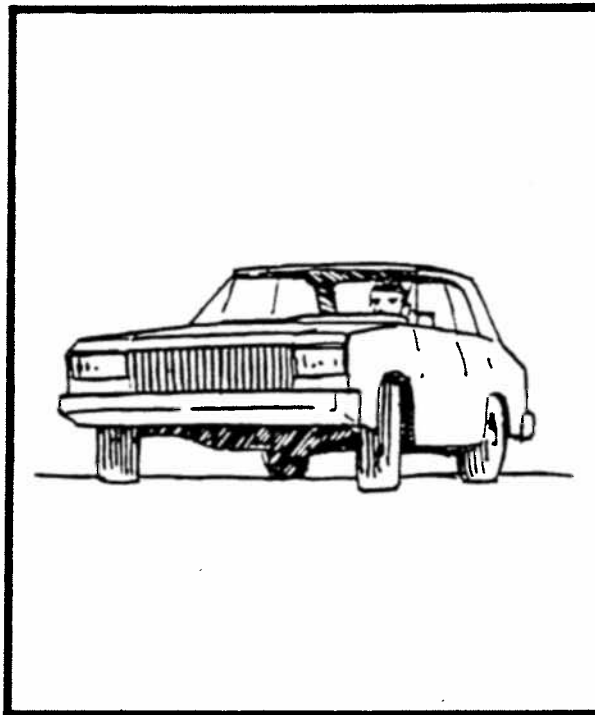

3



4

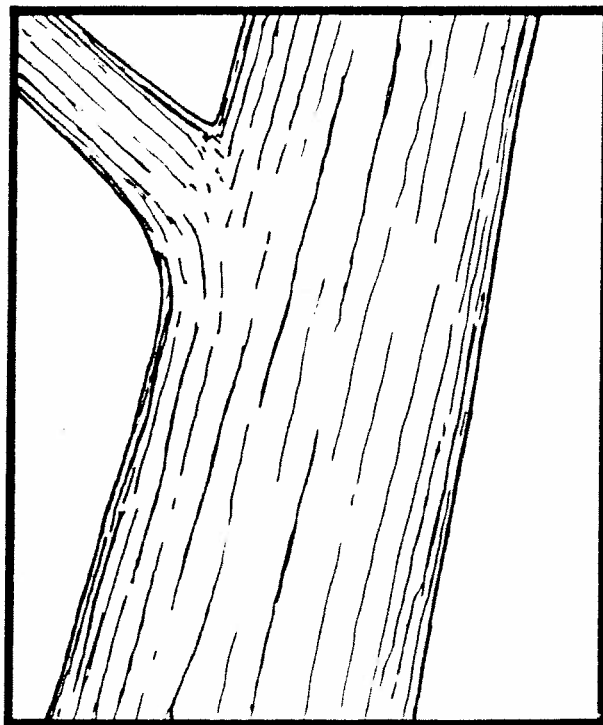

ГАЙКА

1

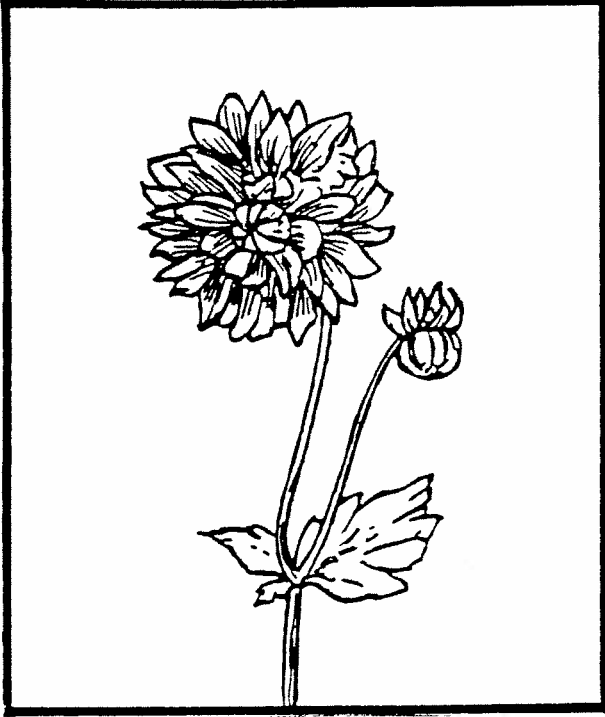

2

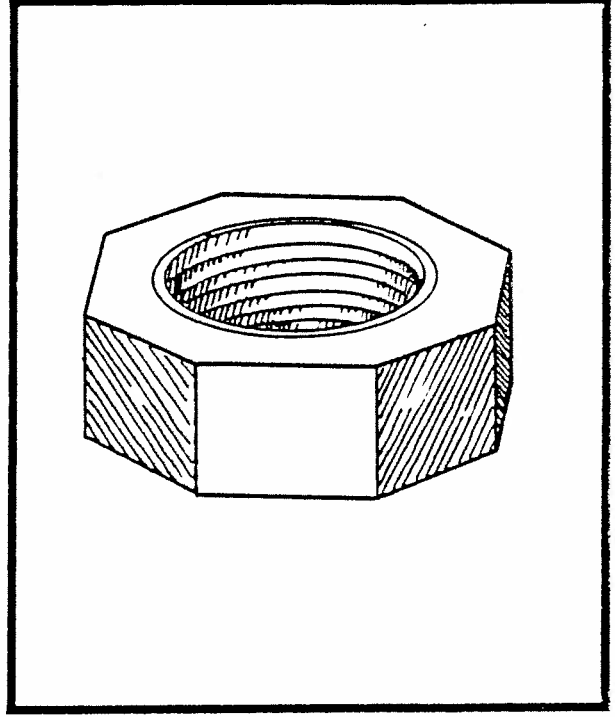

3

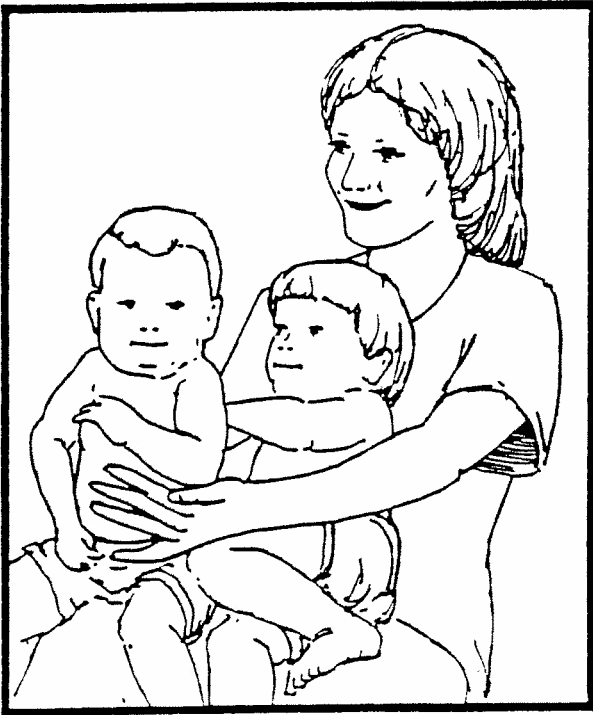

4

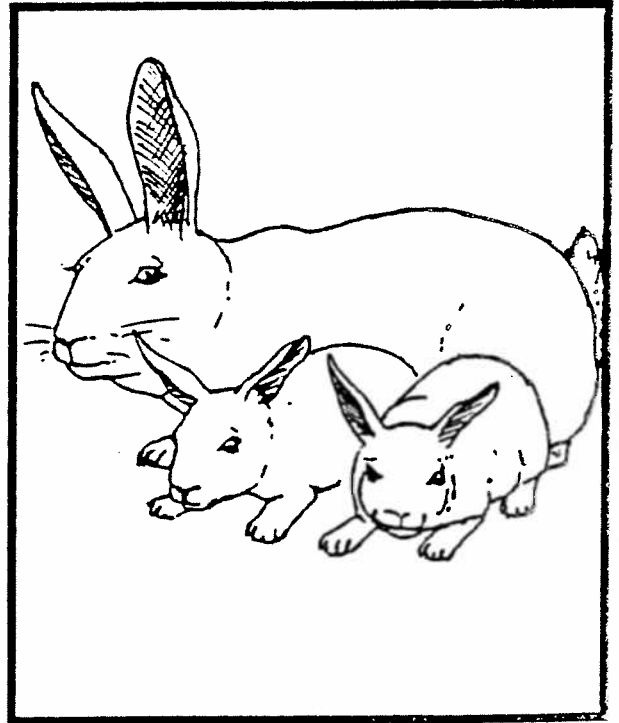

ЛОСТ

1

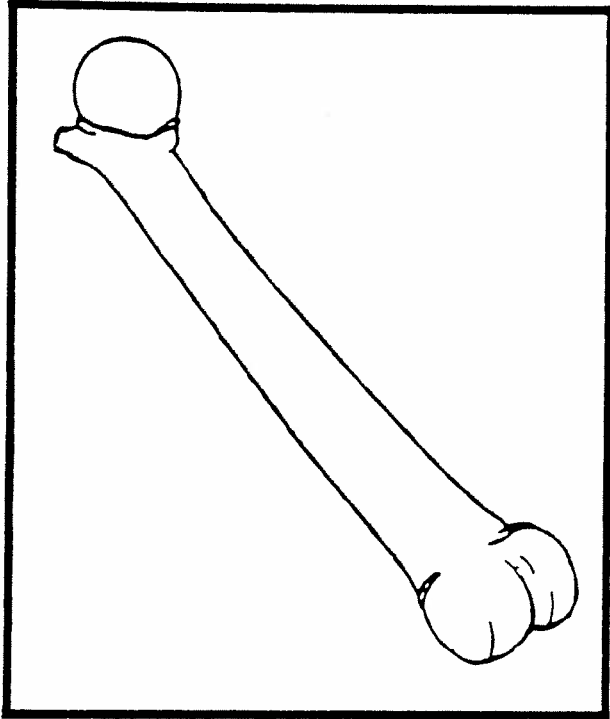

2

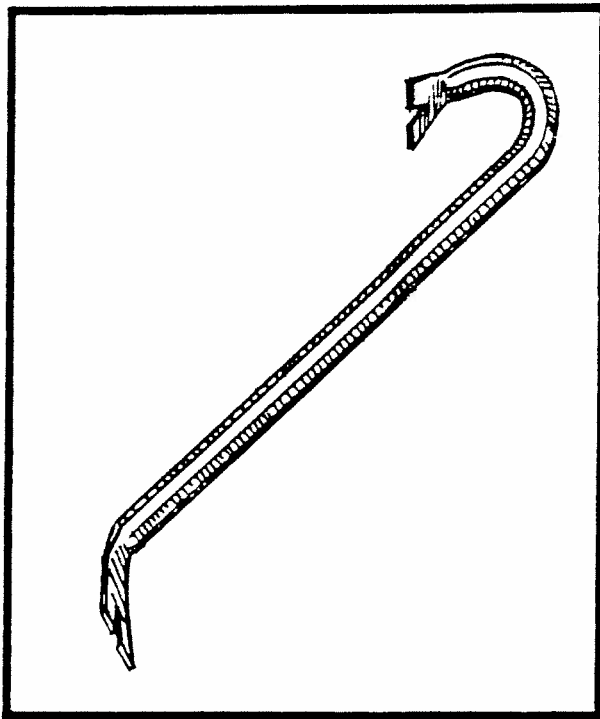

3



4



ДУК

1

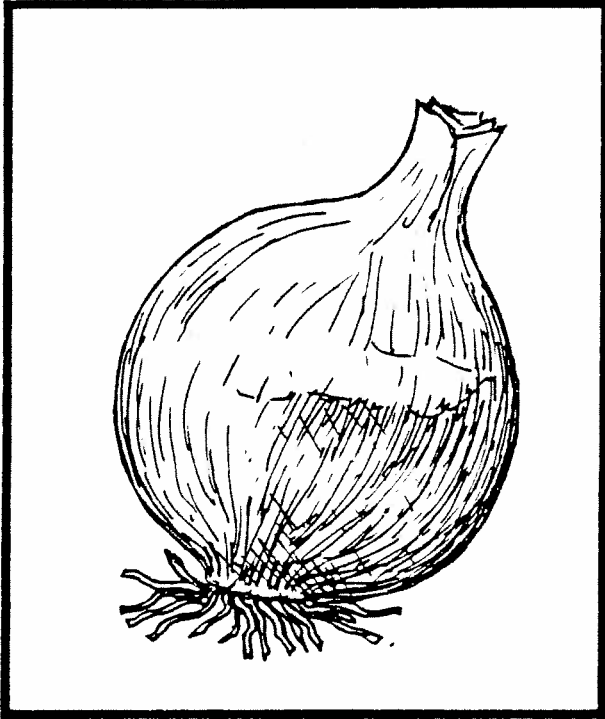

2

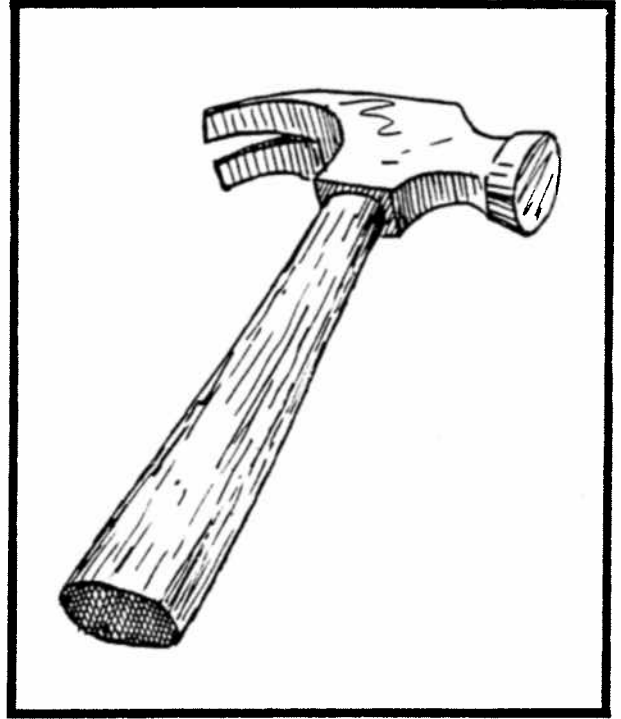

3

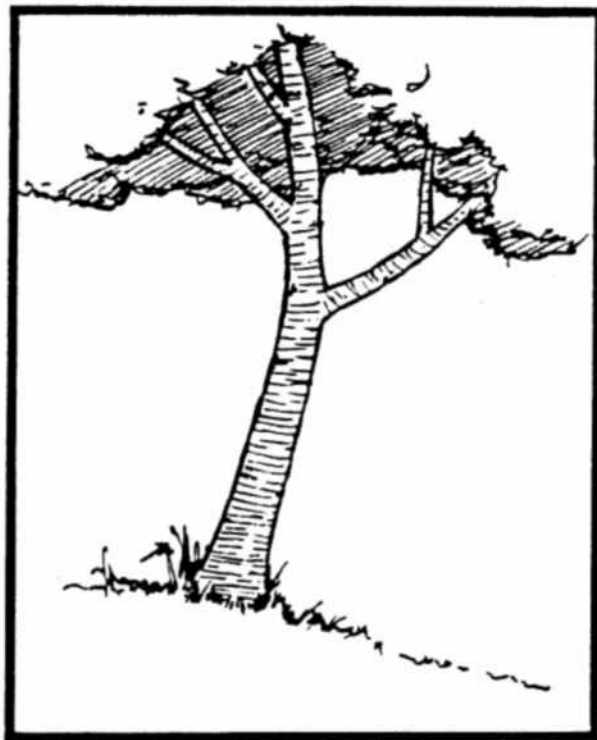

4

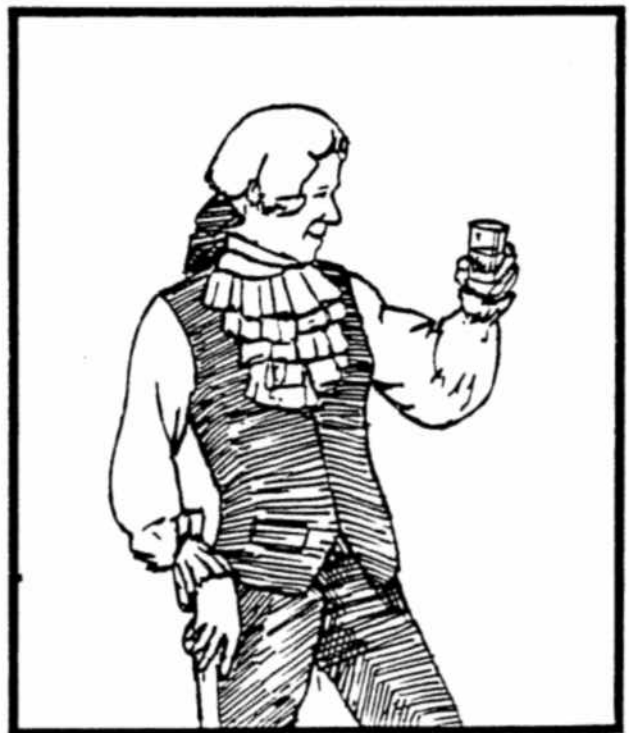

ШАПКА

1

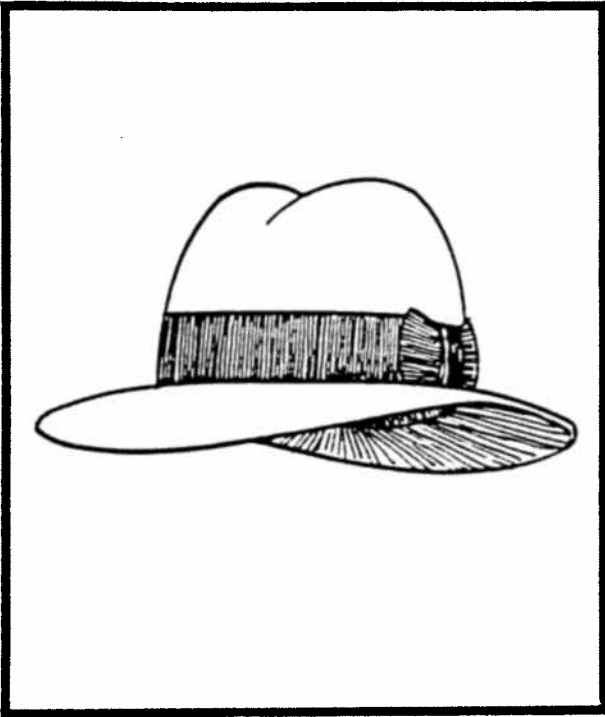

2

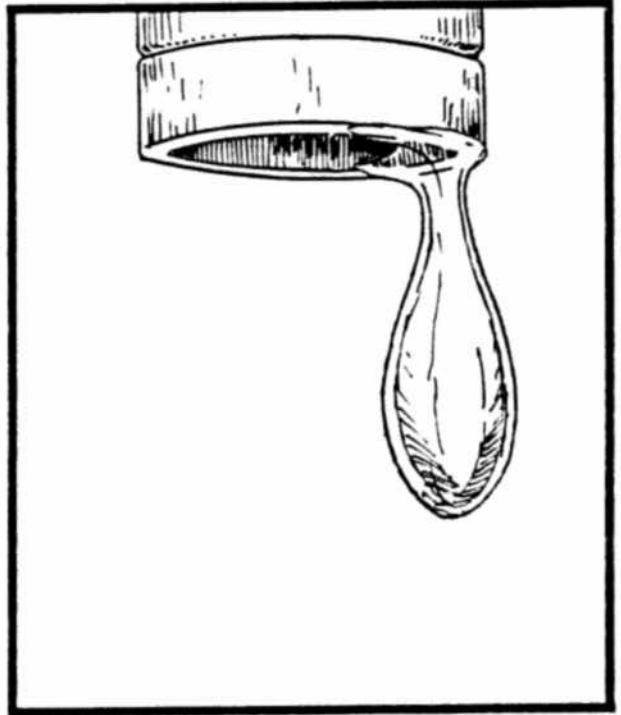

3

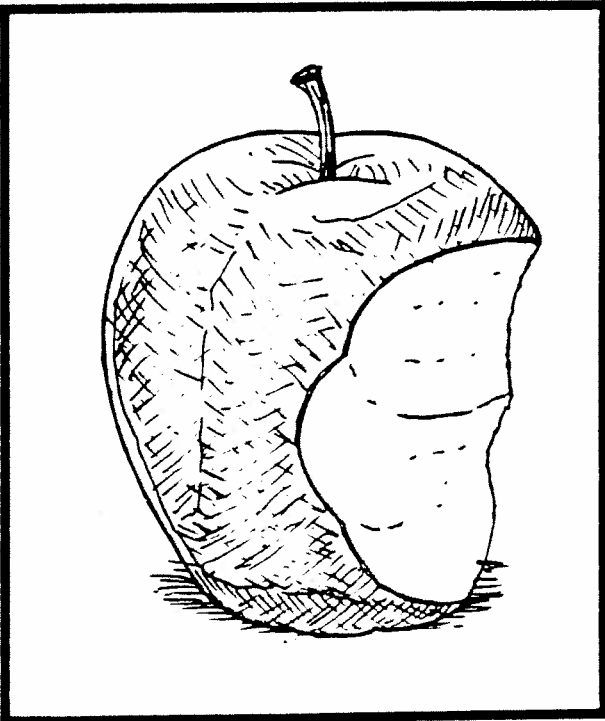

4

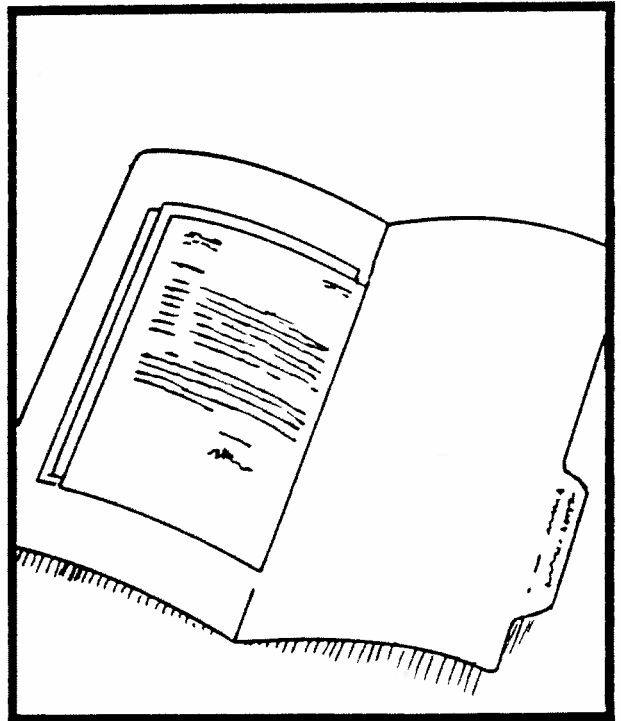

КРЪВ

1



2

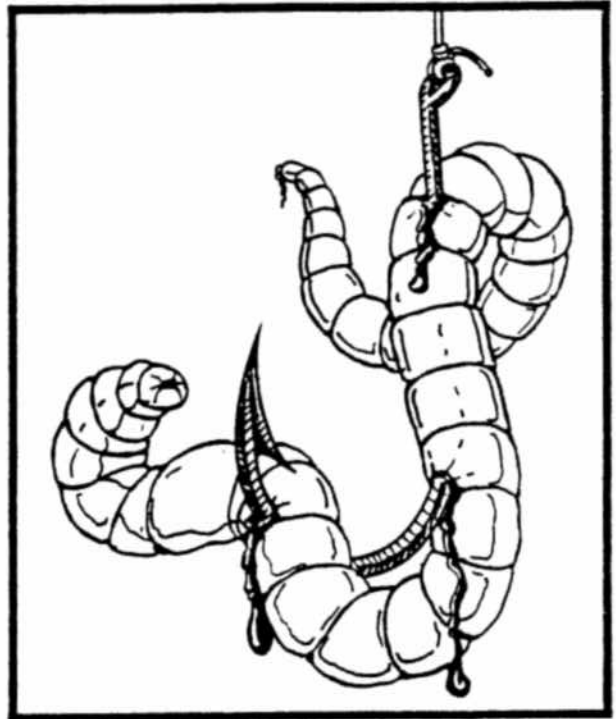

3

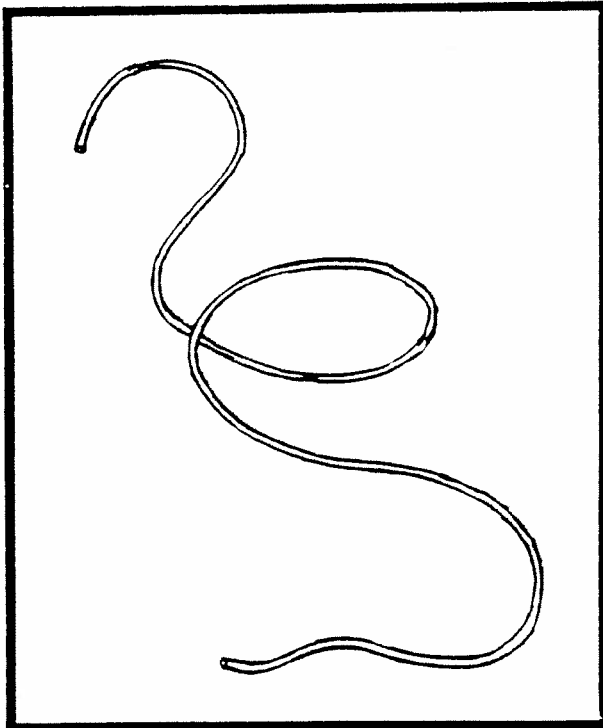

4

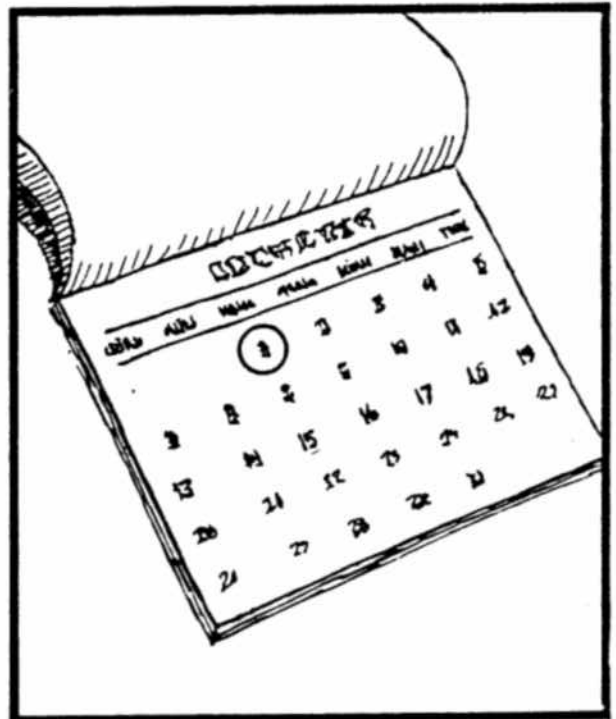

KPAK

1

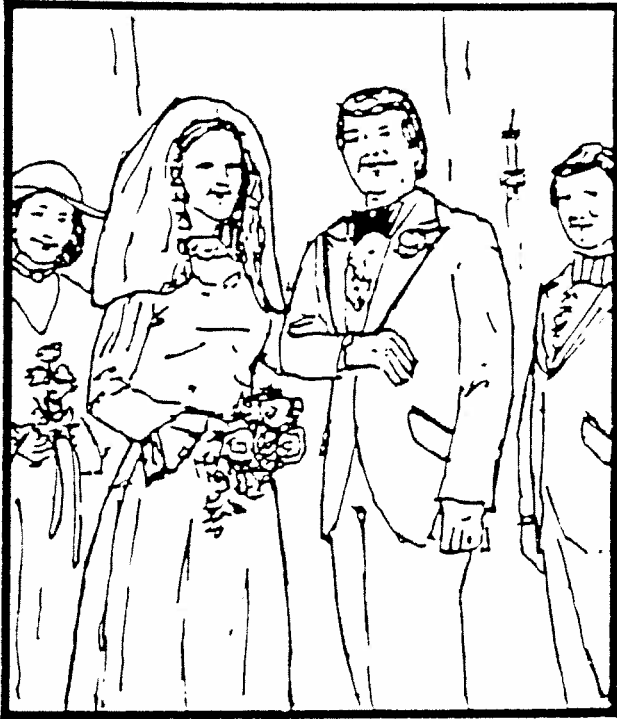

2

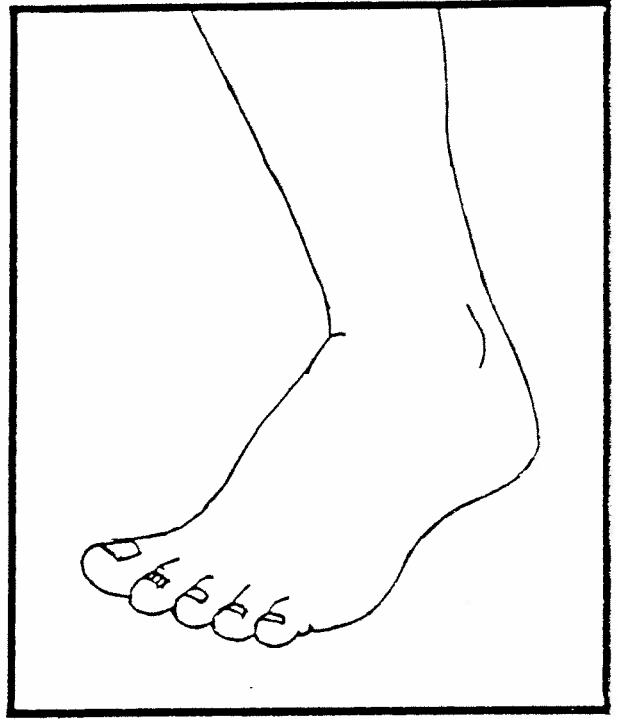

3



4



РИСУНКИ

ЧЕТЕНЕ НА УМ (СХВАЩАНЕ НА СМИСЪЛА, ИЗРЕЧЕНИЯ)

МОМЧЕТО ДЪРЖИ МОМИЧЕТО

1

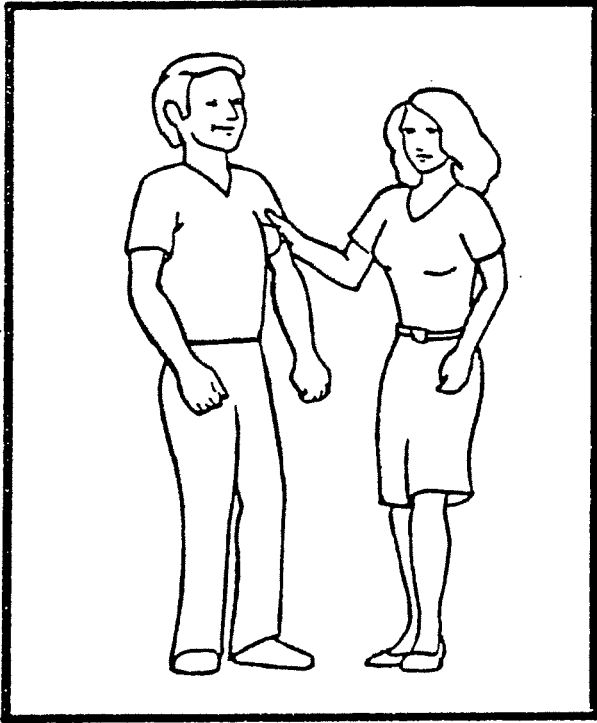

2

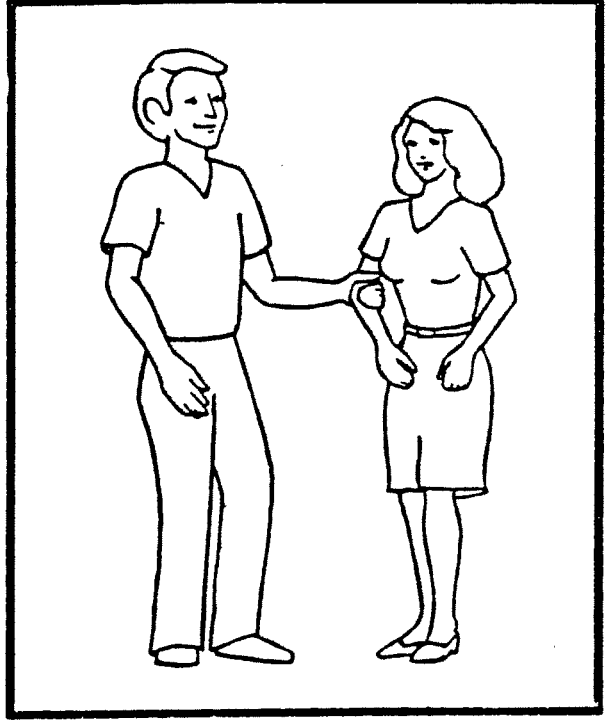

3

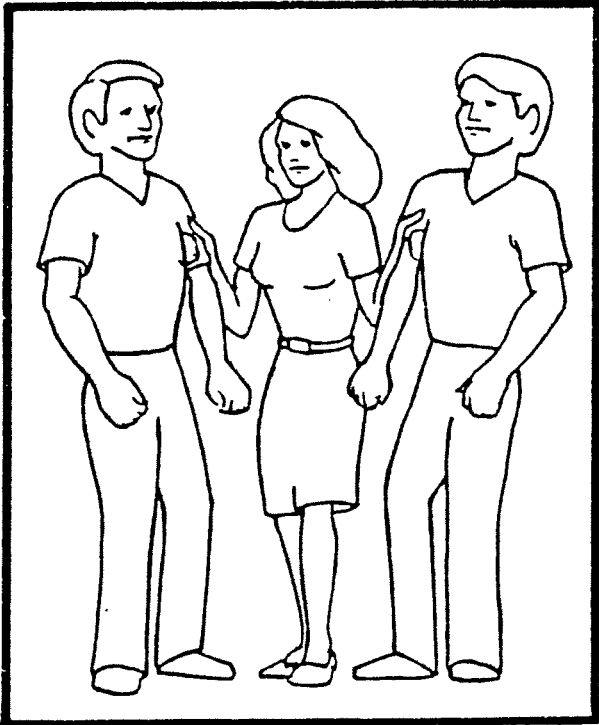

4

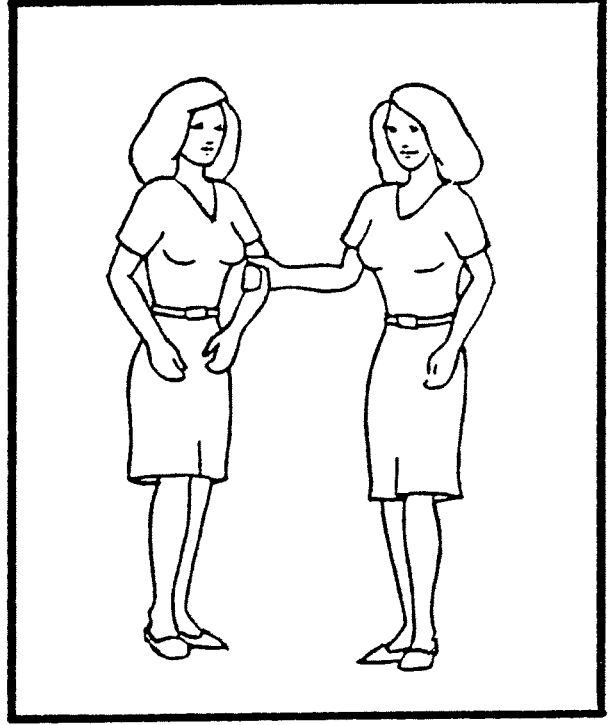

ТОЙ СЕ КЪПЕ

1



2

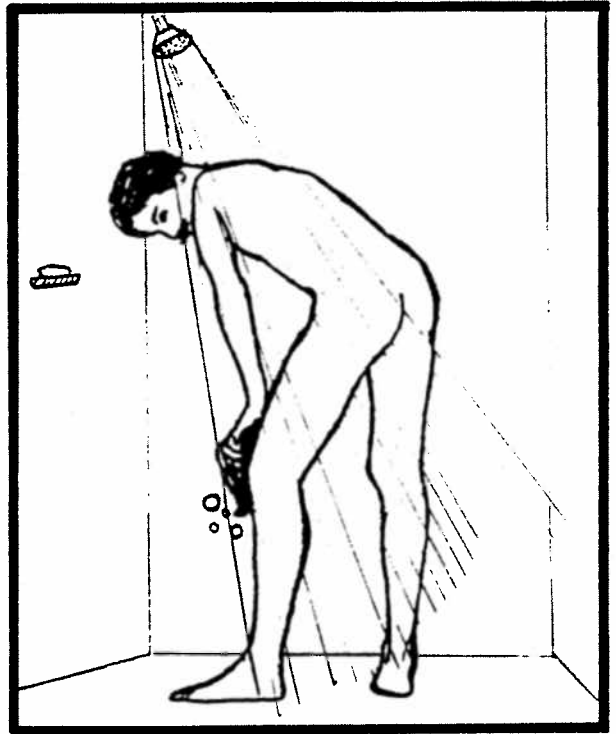

3

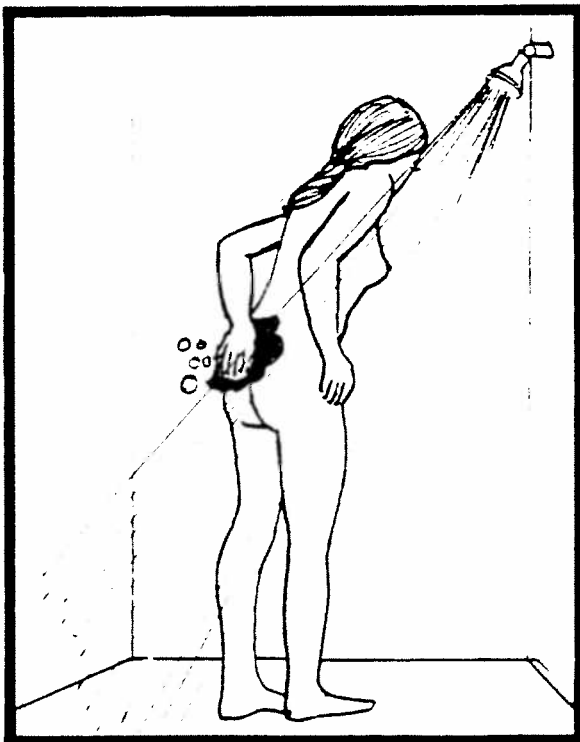

4



КУЧЕТО Е УХАПАНО ОТ КОТКАТА

1

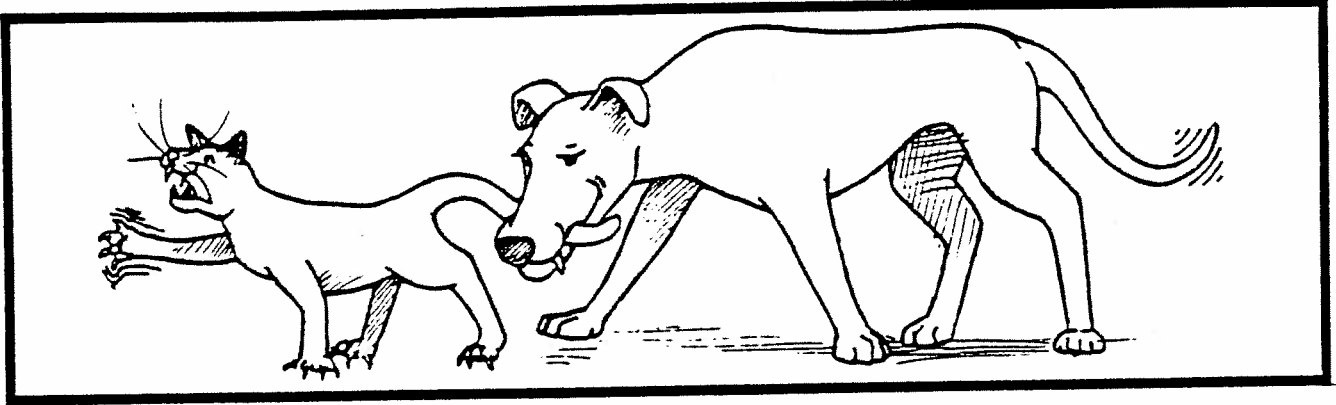

2

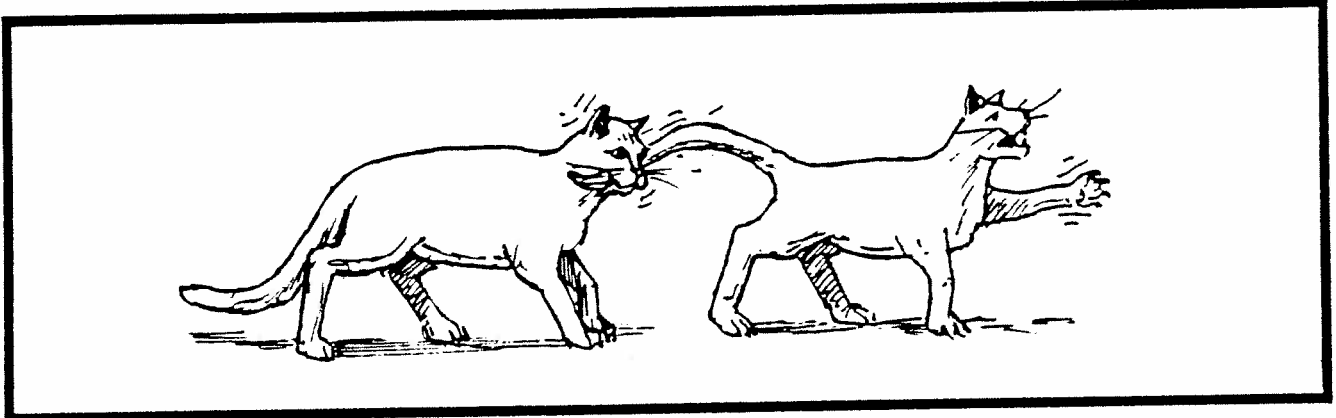

3

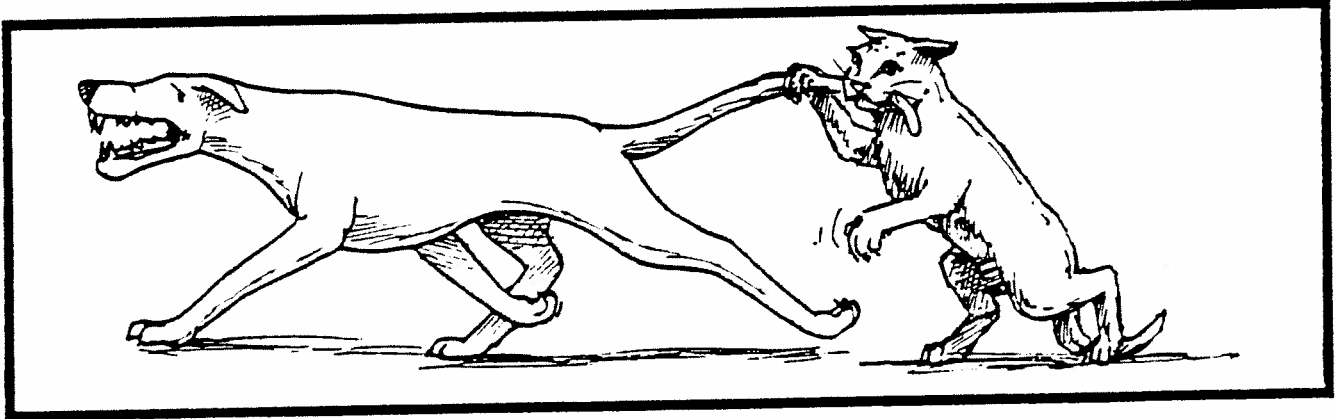

4

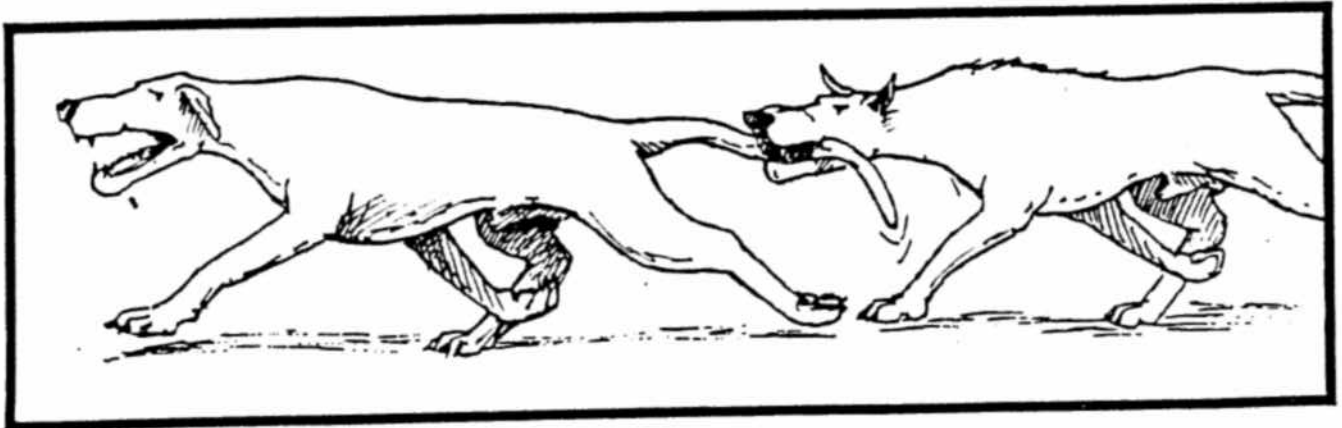

КАМИОНЪТ Е, КОЙТО ТЕГЛИ КОЛАТА

1

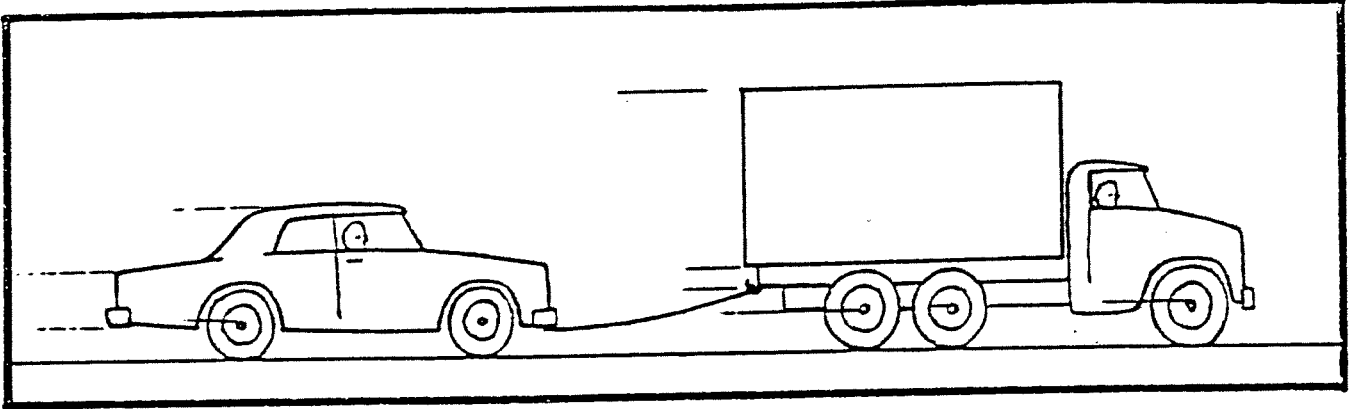

2

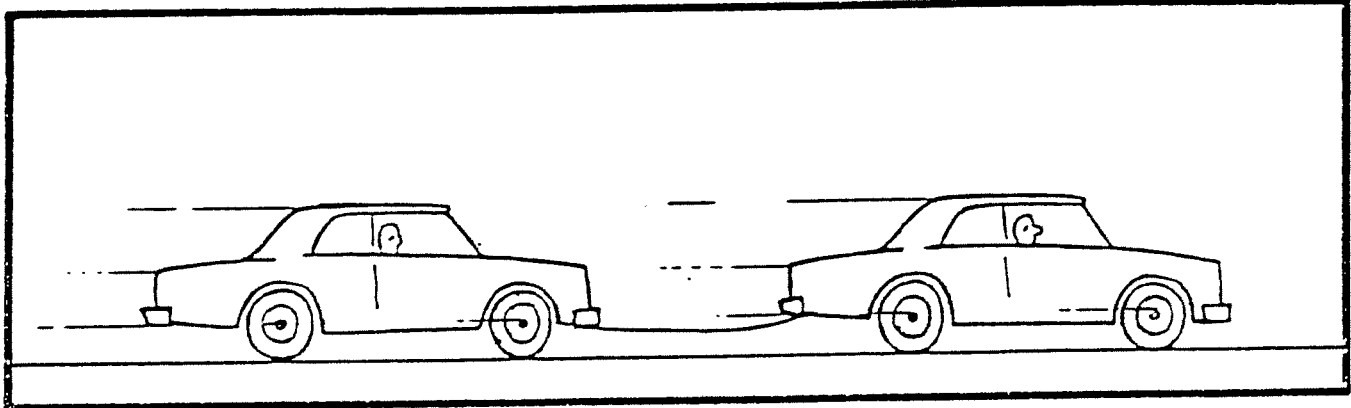

3

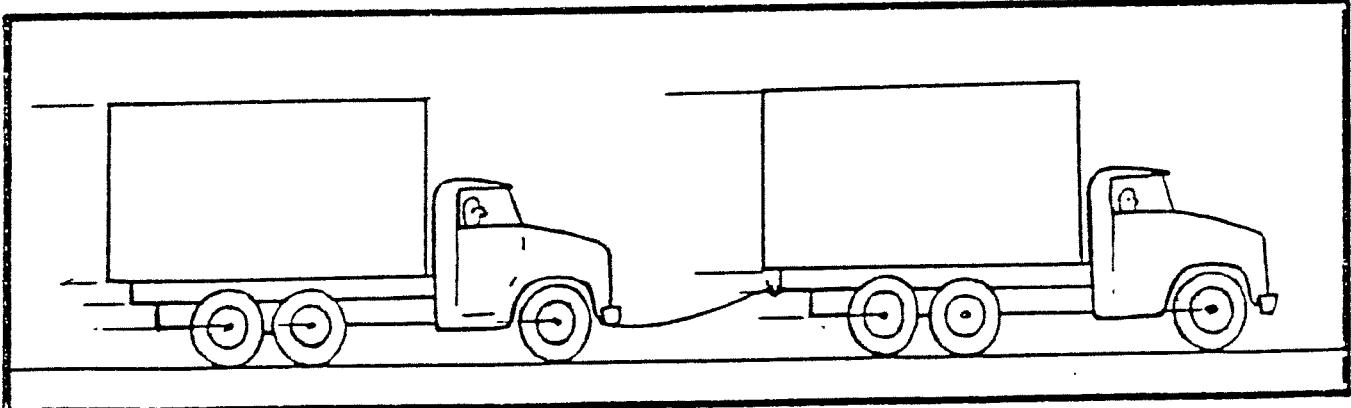

4

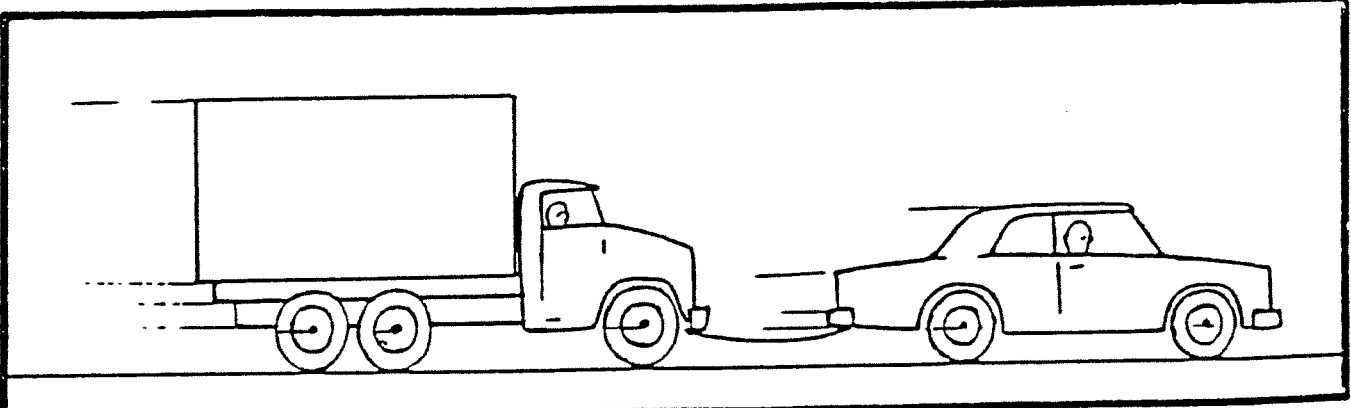

МОМЧЕТО НЕ БЛЪСКА МОМИЧЕТО

1

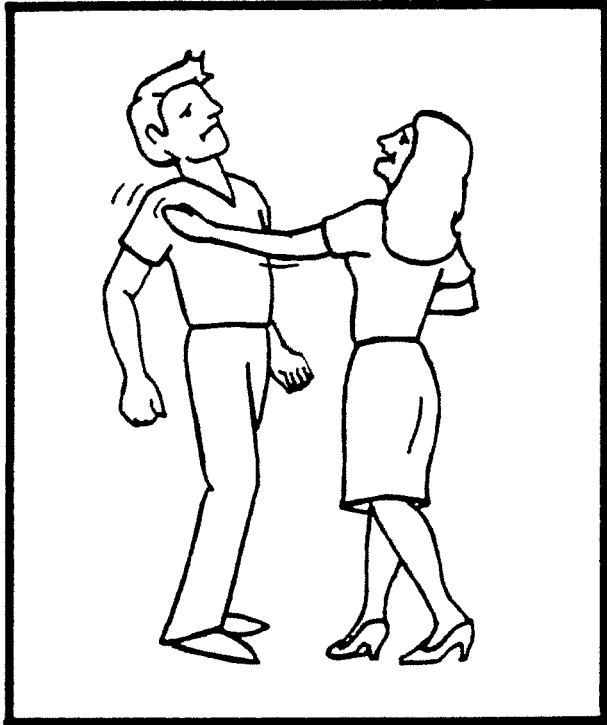

2

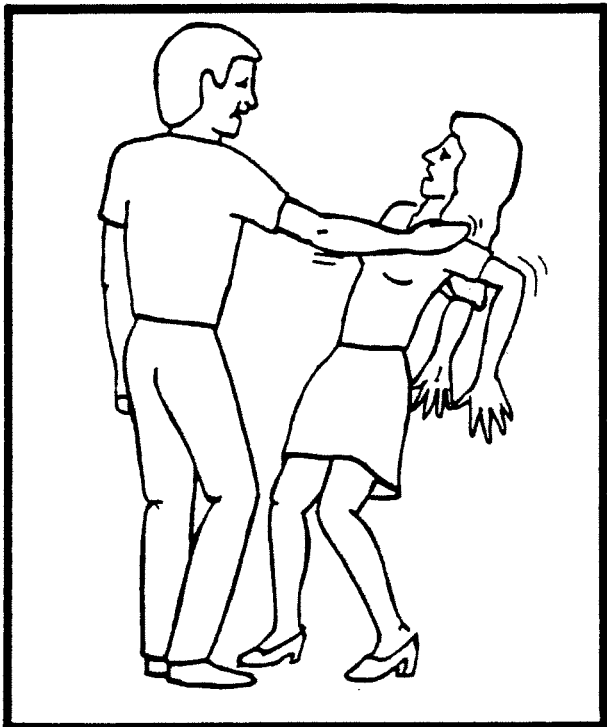

КАМИОНЪТ НЕ Е ТЕГЛЕН ОТ КОЛАТА

1

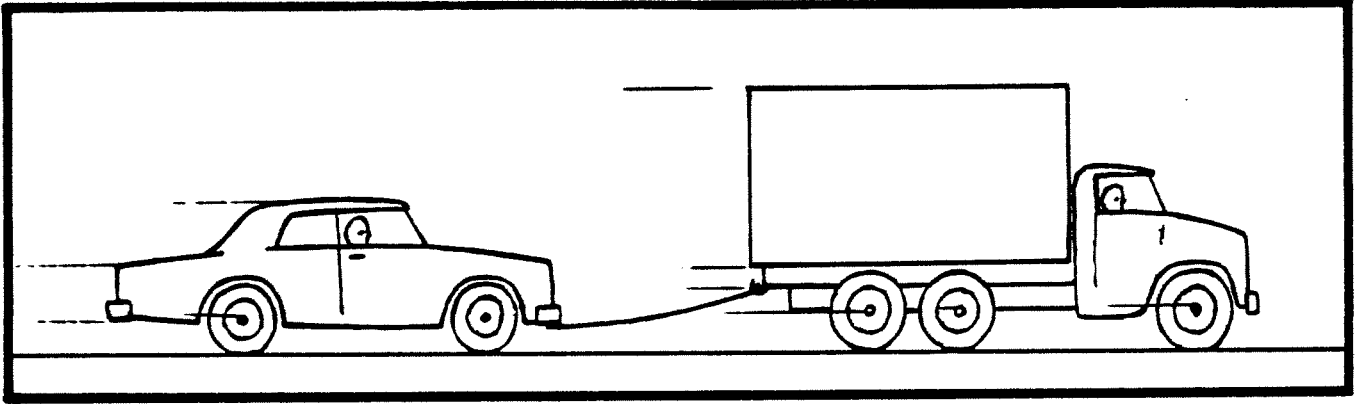

2

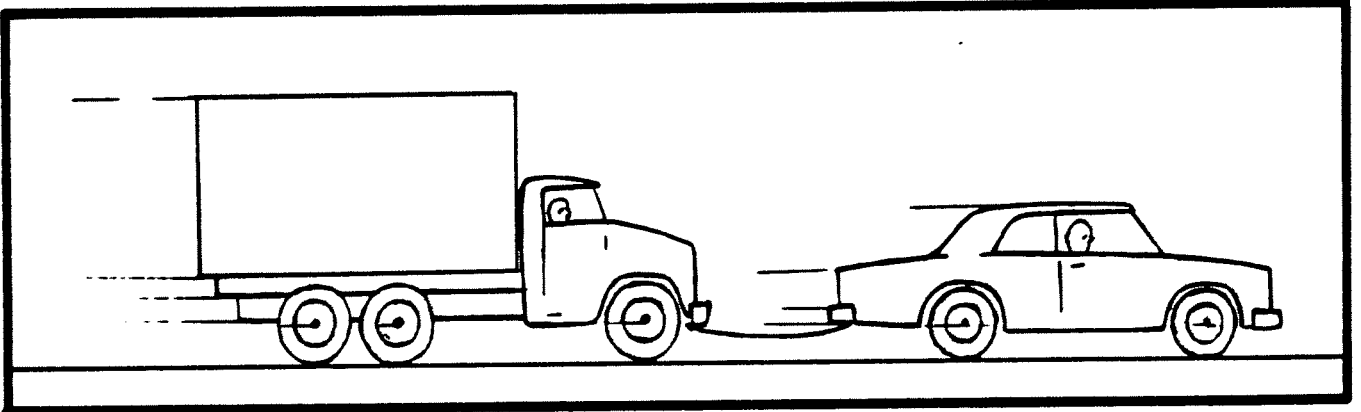

КУЧЕТО Е, КОЕТО КОТКАТА ХАПЕ

1

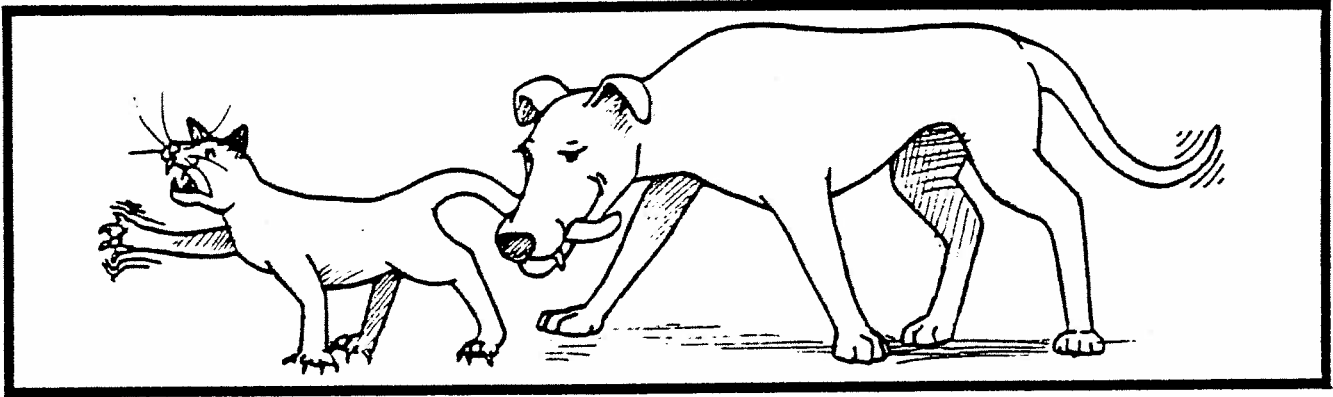

2

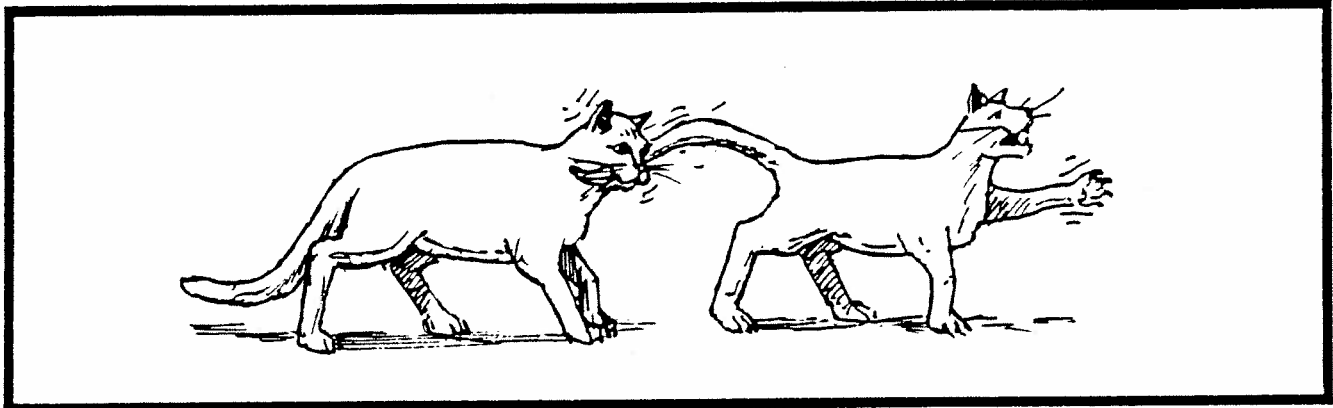

3

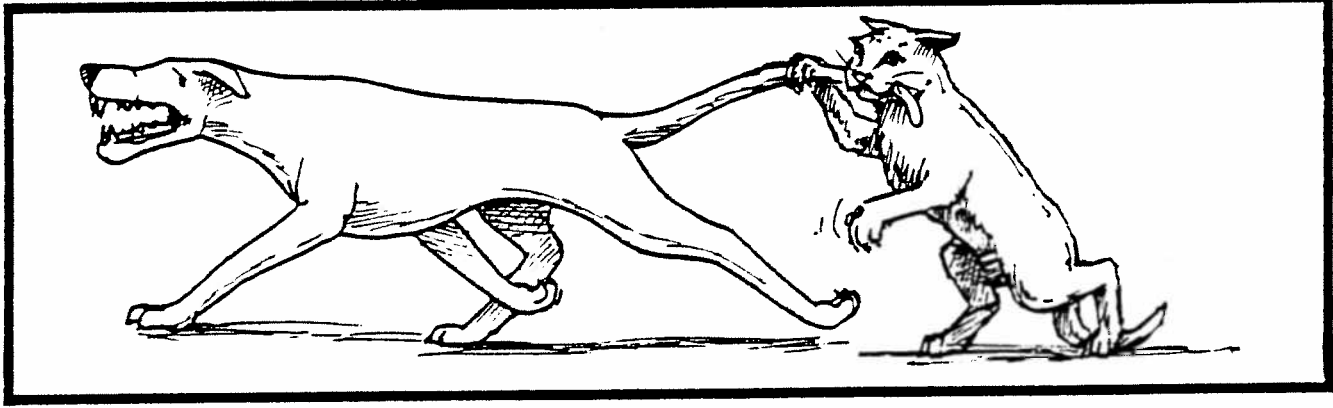

4

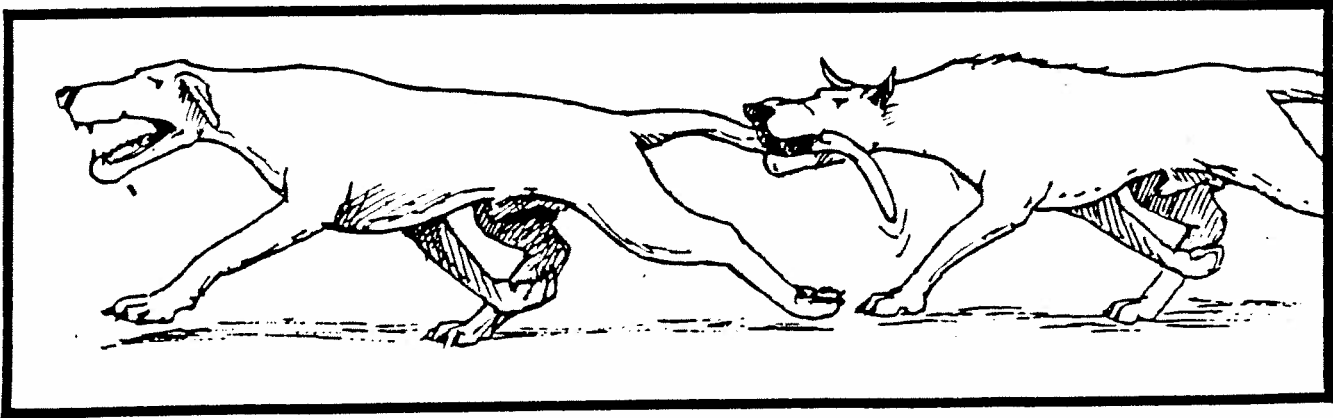

ТОЙ Я ДЪРЖИ

1

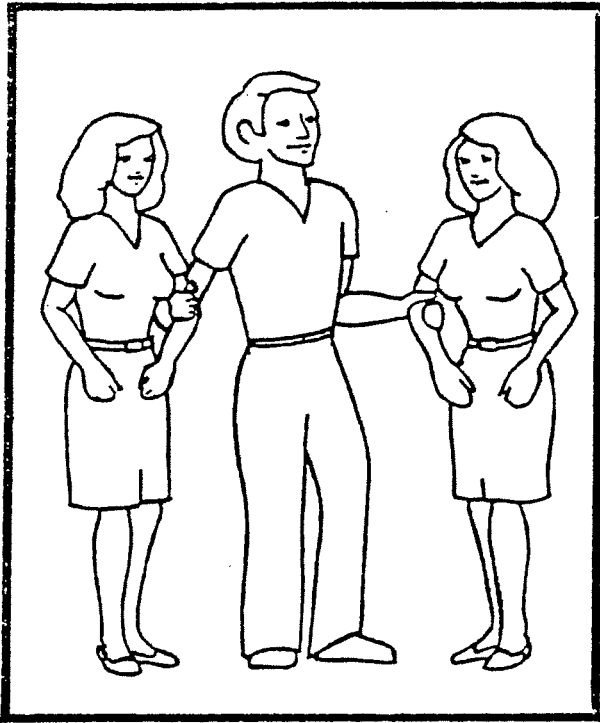

2

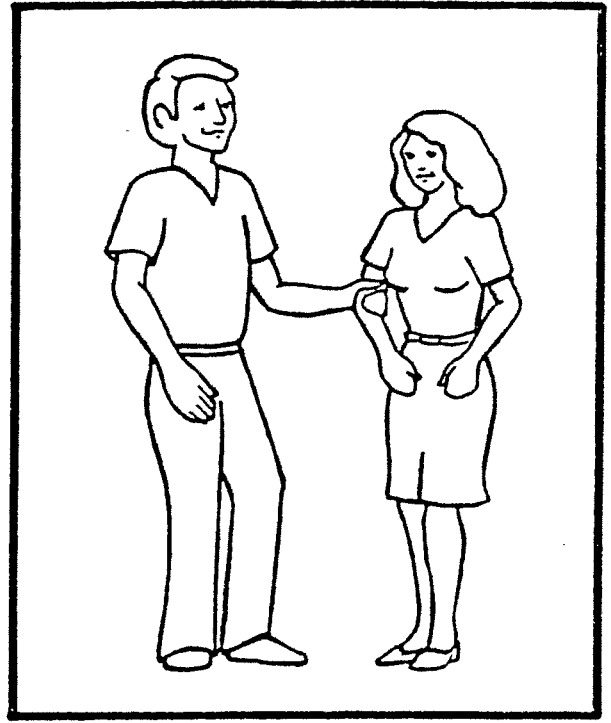

3

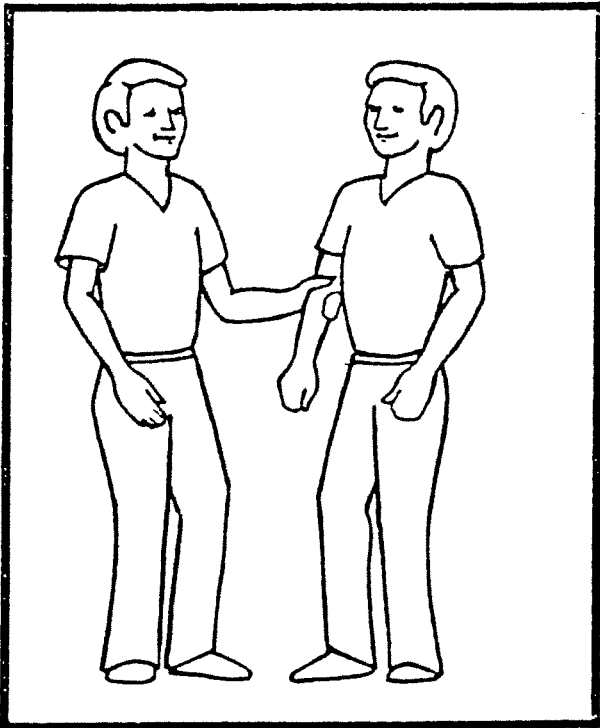

4

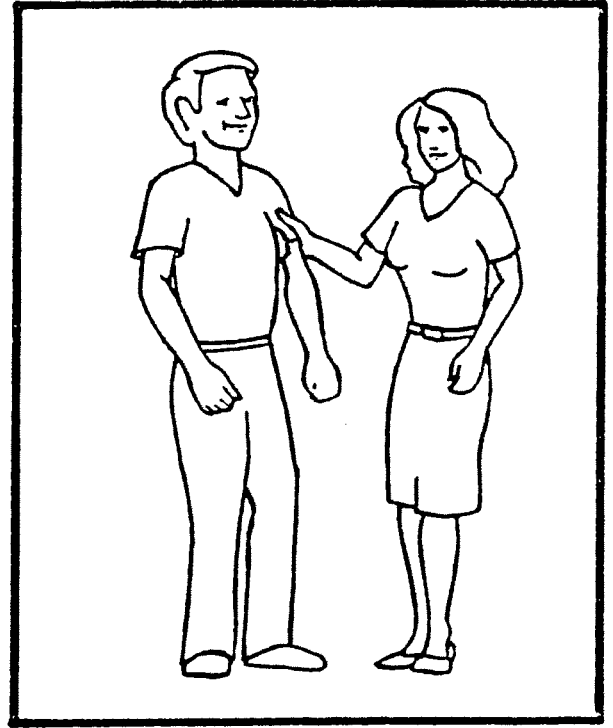

МОМИЧЕТО Е БЛЪСНАТО ОТ МОМЧЕТО

1

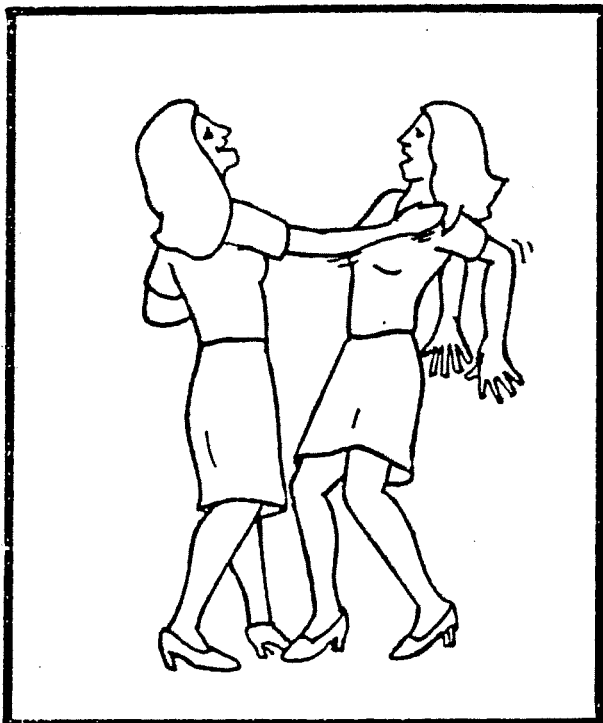

2

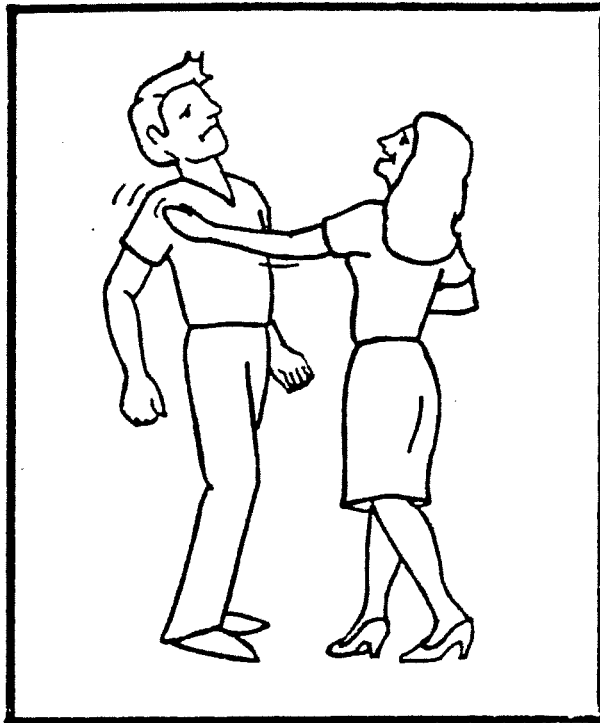

3

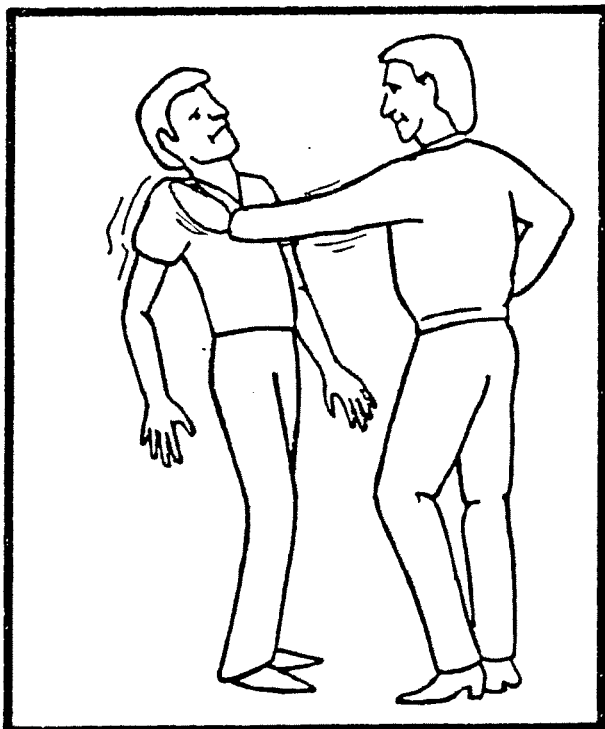

4

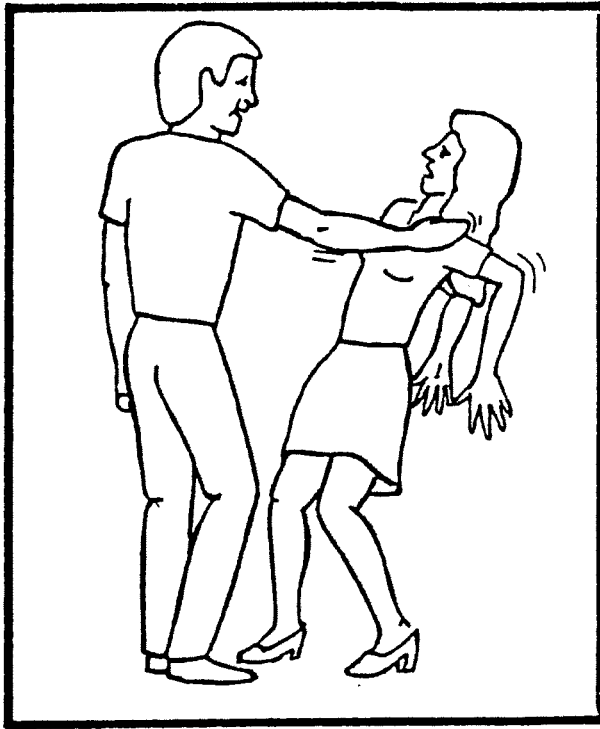

МОМИЧЕТО НЕ Е ЦЕЛУВАНО ОТ МОМЧЕТО

